

COMPAQ

*IJ650 Series
Color Inkjet Printer*



Getting Started Guide

Notice

© Copyright 2001 Compaq Computer Corporation

COMPAQ and the Compaq logo Registered in U.S. Patent and Trademark Office. Microsoft and Windows are trademarks of Microsoft Corporation.

All other product names mentioned herein may be trademarks or registered trademarks of their respective companies.

Compaq shall not be liable for technical or editorial errors or omissions contained herein. The information in this document is subject to change without notice.

THE INFORMATION IN THIS PUBLICATION IS SUBJECT TO CHANGE WITHOUT NOTICE AND IS PROVIDED "AS IS" WITHOUT WARRANTY OF ANY KIND. THE ENTIRE RISK ARISING OUT OF THE USE OF THIS INFORMATION REMAINS WITH RECIPIENT. IN NO EVENT SHALL COMPAQ BE LIABLE FOR ANY DIRECT, CONSEQUENTIAL, INCIDENTAL, SPECIAL, PUNITIVE OR OTHER DAMAGES WHATSOEVER (INCLUDING WITHOUT LIMITATION, DAMAGES FOR LOSS OF BUSINESS PROFITS, BUSINESS INTERRUPTION OR LOSS OF BUSINESS INFORMATION), EVEN IF COMPAQ HAS BEEN ADVISED OF THE POSSIBILITY OF SUCH DAMAGES. THE FOREGOING SHALL APPLY REGARDLESS OF THE NEGLIGENCE OR OTHER FAULT OF EITHER PARTY AND REGARDLESS OF WHETHER SUCH LIABILITY SOUNDS IN CONTRACT, NEGLIGENCE, TORT, OR ANY OTHER THEORY OF LEGAL LIABILITY, AND NOTWITHSTANDING ANY FAILURE OF ESSENTIAL PURPOSE OF ANY LIMITED REMEDY.

The limited warranties for Compaq products are exclusively set forth in the documentation accompanying such products. Nothing herein should be construed as constituting a further or additional warranty.

Compaq IJ650
First Edition (May 2001)

Getting Started Guide

This booklet guides you step by step from setup through printing your first document using Windows 98, Windows Me, or Windows 2000.

See page 13 for information about contacting Compaq and locating your printer warranty.

Setup

For setup, you will need:

- > A computer with a CD-ROM drive and USB port
- > A USB cable (purchased separately)
- > Letter or A4 size paper

Step 1: Check the printer parts

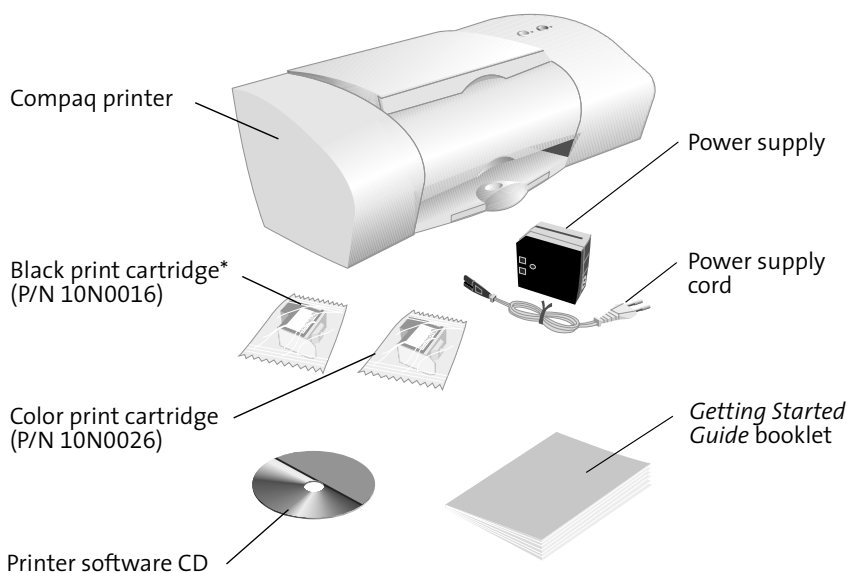

* May be included on some models.

Step 2: Connect the power supply

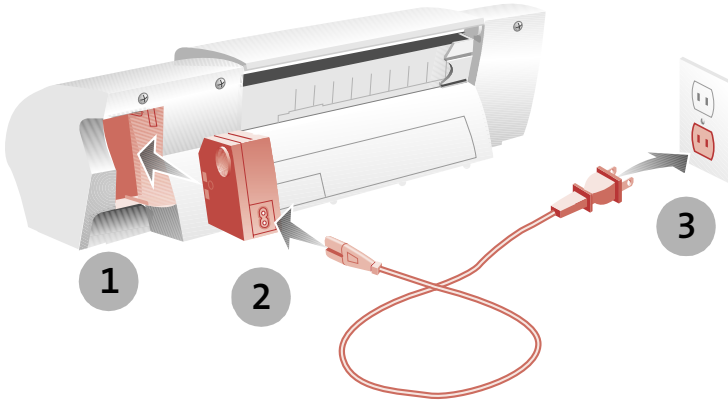

If the Power light doesn't come on:

- 1 Check the power supply connections.
- 2 Press the Power button.

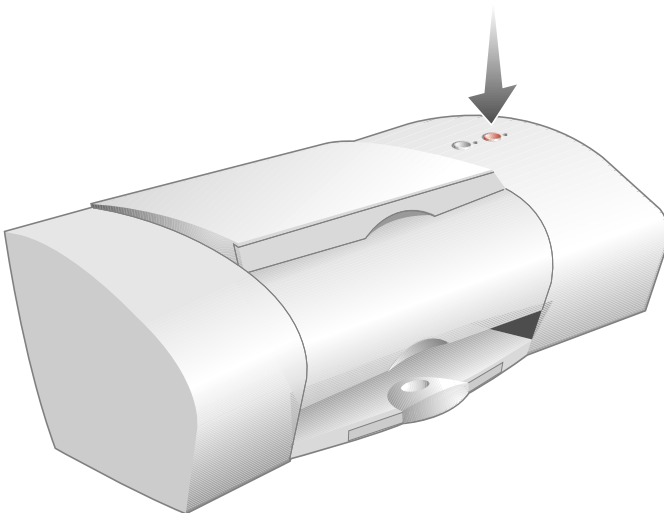

Step 3: Install the print cartridges

If your printer came with:	You can print with:
Color print cartridge only (P/N 10N0026)	<ul style="list-style-type: none"> > Only the color print cartridge in the left carrier > Only a black print cartridge* in the right carrier > Both a color and a black print cartridge*
Color print cartridge (P/N 10N0026) and a Black print cartridge (P/N 10N0016)	<ul style="list-style-type: none"> > Only the color print cartridge in the left carrier > Only the black print cartridge in the right carrier > Both the color and the black print cartridge
* You must purchase a black print cartridge (P/N 10N0016) separately.	

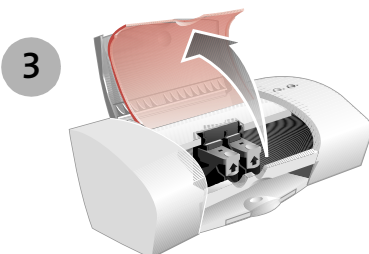
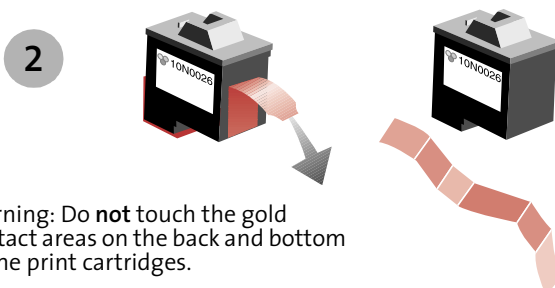
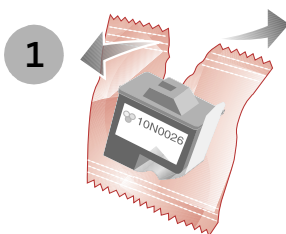

Note: The cartridge carrier moves to the loading position when you open the front cover.

If your printer came with:

One Cartridge:

Two Cartridges:

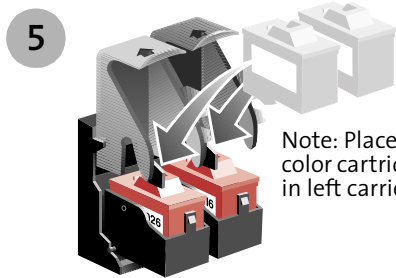
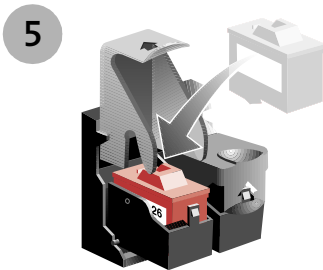
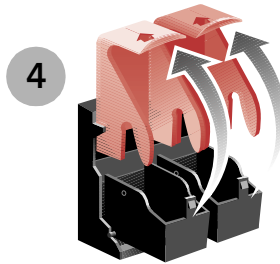
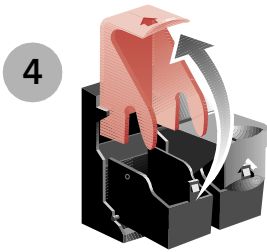

Note: Place color cartridge in left carrier.

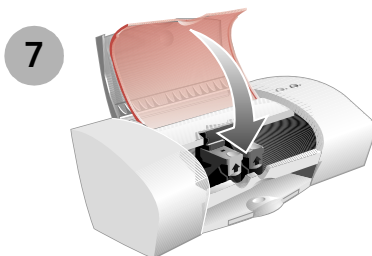
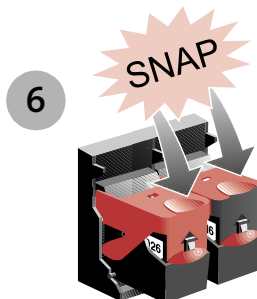
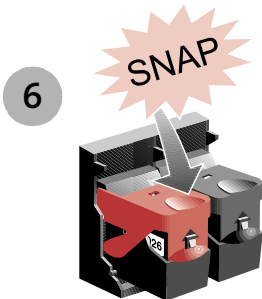

Step 4: Connect the USB cable

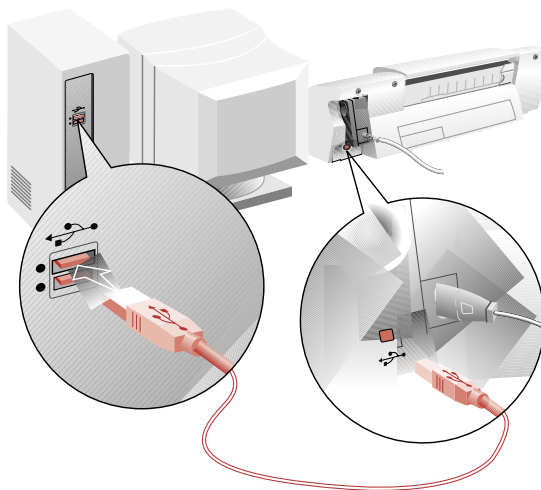

The location and orientation of the USB port on your computer may be different from the one shown.

Step 5: Load up to 100 sheets of plain paper

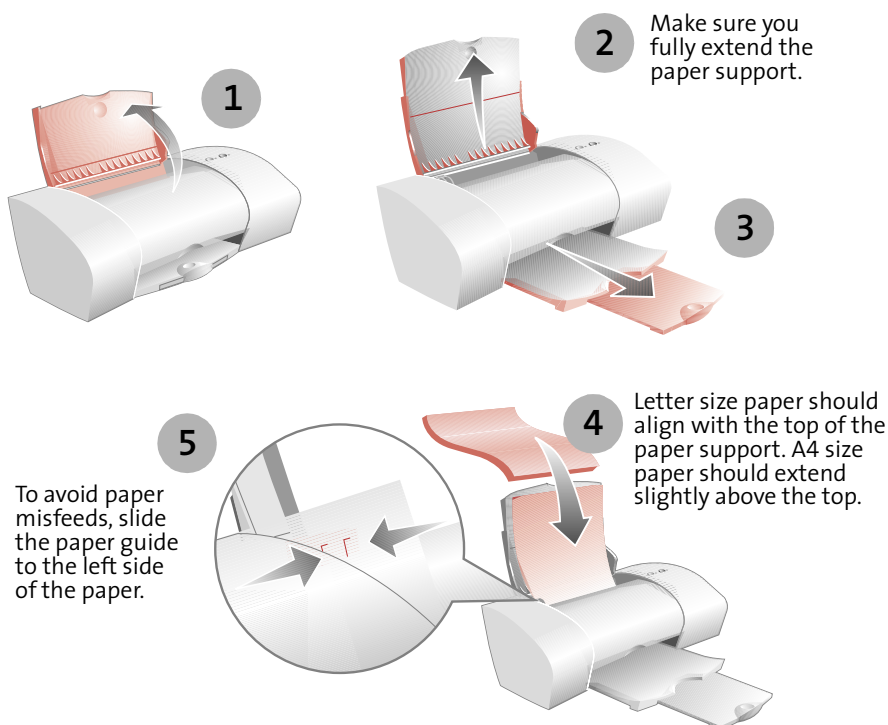

Step 6: Install the printer software

Now that you have set up your printer, you are ready to install the printer software.

1



Click **Cancel** on any screens similar to the one shown.

If your computer is not already on, please turn it on now.

2

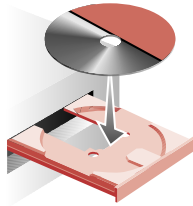

3

Wait for the Compaq printer software installation screen shown in 4 to appear. If it doesn't, see page 11.

4

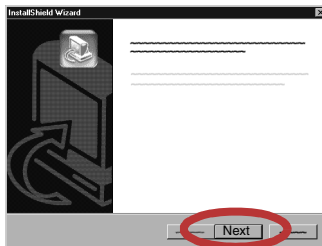

Click **Next** and follow the instructions until the installation is complete.

Congratulations!

You have finished setting up your printer.

Printing

Now that you have set up your printer and installed the printer software, you are ready to print your first document.

Basic printing

Basic printing is as easy as:

- 1 Load the paper.
- 2 Open the file you want to print.
- 3 Customize the printer settings. (For help, see the section below, “Using the printer software.”)
- 4 Print your document.

Using the printer software

Use the Printer Properties (or Printing Preferences) to customize settings so your document prints the way you want it. There are several ways to access your Printer Properties:

- > From the Start menu, click **Programs ▶ Compaq IJ650 ▶ Compaq IJ650 Properties**.
- > From the Start menu, click **Settings ▶ Printers**. From the Printers folder, right-click on the Compaq IJ650 icon and select **Properties**.
- > From your software application, click **File ▶ Print ▶ Properties**.

For example, to print the first page of the Getting Started Guide:

- 1 Load plain paper. For help, see page 5.
- 2 From the Start menu on your desktop, click **Programs ▶ Compaq IJ650 ▶ Compaq IJ650 Getting Started Guide**.
- 3 From the Guide, click **File ▶ Print ▶ Properties**
 - a From the Quality/Color tab, drag the Print Quality slider to the left to print *quickly*, but in *lower quality*.

Note: Selecting a higher Quality/Speed setting results in better print quality, but your documents may take longer to print.

Getting Started Guide

- b To learn more:
 - > Explore the other tabs in the Printer Properties.
 - > Explore the menus.
 - > Click **Help** to view the printer software Help. From the **File** menu, click **Exit** when you are finished viewing the Help.
 - c Click **OK** to apply the settings and close the Printer Properties.
- 4 In the Print Range area of the Print dialog box, select **Current Page**.
 - 5 Click **OK** to print the current page of the Getting Started Guide.

Printing photos

To print the best looking photos:

- 1 Use photo paper. We recommend Compaq Inkjet Photo-Glossy Media.
- 2 In Printer Properties:
 - > Select the Glossy paper type, if you are using glossy paper.
 - > Select the Color Photo icon.
 - > Choose a print quality of 600x600 dpi or higher.
- 3 Close Printer Properties and print.

Printing envelopes

To print on envelopes:

- 1 Load up to 10 envelopes vertically, with the print side facing you.
- 2 Adjust the paper guide so it is against the side of the envelopes.
- 3 The stamp location is in the upper-left corner.
- 4 Select the envelope type from the Paper tab of Printer Properties.
- 5 Close Printer Properties and print.

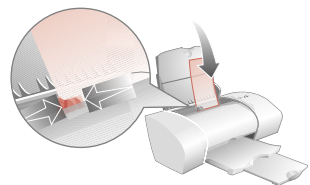

Printing multiple pages per sheet of paper

You can print two, four, or nine “pages” of your document on a single sheet of paper. Explore the **Layout** tab of the Printer Properties for these and many other layout options.

Printing banners

To print a banner, you should have banner paper and software that supports banner printing.

- > Place the banner paper behind the printer.
- > Bring the unattached edge of the first page over the printer and into the sheet feeder.
- > Place the paper guide against the side of the paper.
- > Select **Banner** or **Banner A4** on the **Paper** tab of the Printer Properties.
- > Print your banner.

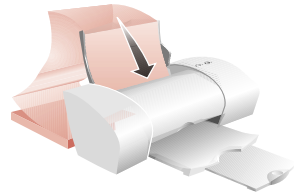

Printing transparencies

If you have transparency film:

- > Load the transparency so the rough side is facing you (smooth side down).
- > Place the paper guide against the edge of the transparency.
- > Select **Transparency** on the **Paper** tab of Printer Properties.
- > Print your transparency.

Getting more from your printer

Your printer is capable of printing many types of projects. Create handouts, booklets, posters, and more. Explore the Compaq IJ650 Printer Properties for additional features.

Compaq Inkjet Media is specifically engineered to give the best results when used with your Compaq inkjet printer. Compaq Inkjet Media may be purchased at your local retailer or on the internet.

With printing software, you can create greeting cards, iron-on transfers, and many other printing projects. Check the Compaq website periodically for printer activities and ideas.

From the Start menu, simply click **Compaq IJ650 ▶ Compaq Online**.

Help

This section will help you when you have problems setting up your printer, or you need general printing help. For additional help, press the **Help** button on the Printer Properties dialog.

The installation screen did not appear

- 1 Make sure you click **Cancel** on any screens similar to ❶ in step 6 on page 6.
- 2 Make sure the Compaq printer software CD is in your CD-ROM drive.
- 3 From the desktop, double-click **My Computer**.
- 4 Double-click the CD-ROM drive icon.
- 5 If necessary, double-click **setup.exe**.
- 6 Continue with ❷ in step 6 on page 6.

The printer light is blinking

Make sure you have properly loaded the paper into the printer. If there is an error message on your screen, follow the instructions on it.

The printer isn't working

Try the following:

- > Check the printer cable. Is it securely plugged into the printer and your computer?
- > Check the printer status:
 - a From the Start menu, click **Settings ▶ Printers**.
 - b From the Printers folder, double-click the icon for your printer.
 - c From the Printer menu, make sure:
 - > **Default Printer** is selected.
 - > **Pause Printing** is not selected.
- > If you have connected your printer to a device such as a scanner or fax machine, disconnect the printer from that device and connect the printer directly to your computer.

Getting Started Guide

- > Check the printer port:
 - a From the File menu of a software application, click **Print** or **Printer Setup**.
 - b In the **Where** area, make sure your printer port is set to USB.
- > Make sure you have not installed multiple copies of the printer software:
 - a From the Start menu, click **Settings** ▶ **Printers**.
 - b In the Printers folder, make sure there is only one icon for your printer.
 - c If you have two printer icons for the same printer, try printing a test page from each icon. Right-click the icon, select Properties, and then click the **Print Test Page ...** button. If the test page prints from one icon and not the other, delete the icon for the printer that does not print.

Uninstalling the software

If there is still a problem, uninstall and then reinstall the printer software:

- 1 From the Start menu, click:
Programs ▶ **Compaq IJ650** ▶ **Uninstall Compaq IJ650**.
- 2 Follow the instructions on your screen.
- 3 To reinstall the printer software, See “Install the printer software” on page 6.

Printer prints blank pages

Make sure you have removed the transparent tape covering the bottom of the print cartridges. For help, see page 3.

Paper misfeeds or multiple sheets feed

- > Make sure you are using a paper recommended for inkjet printers.
- > Do not force the paper down into the printer when you load it. Align the top of the paper with the top of the paper support. Note that A4 size paper will extend slightly above the support.
- > Do not load too much paper in the sheet feeder. The printer will hold up to 100 sheets of plain printer paper.
- > Adjust the left paper guide so it rests against the left edge of the paper, but not so tight as to bow the paper in the feeder.
- > Make sure the printer is on a flat, level surface.

Paper Jams

Try removing the paper from the sheet feeder. If the paper is lodged too far into the printer and can't be removed:

- 1 Press the Power button to turn the printer Off.
- 2 Pull firmly on the paper to remove it. Raise the front cover and pull the paper from the front if necessary.
- 3 Close the front cover.
- 4 Press the Power button to turn the printer On.
- 5 Print your document again.

Pages have poor print quality

- > Check the ink level graphic on the Cartridges tab of your Printer Properties. An ink cartridge may be out of ink or low on ink.
- > Check the print quality setting on your Printer Properties. Try a higher quality setting.
- > Use a different brand of paper. Each brand of paper accepts ink differently and prints with slight color variations. It is recommended that you use Compaq Inkjet Media for the best results.
- > Align and/or clean the print cartridges from the Printer Properties Maintenance tab.
- > Don't use refilled print cartridges. For best results, use Compaq recommended supplies.

Contacting Compaq

Visit our Web site at www.compaq.com to:

- > Access publications for your printer.
- > Download software updates.
- > Search for solutions to common problems.
- > Learn new ways to use your printer.
- > Look for special offers and purchase inkjet supplies and media.

To quickly navigate to the Compaq website, click **Start ▶ Program Files ▶ Compaq IJ650 ▶ Compaq Online.**

Compaq Warranty Information

How do I obtain warranty service?

You may access product technical support on Compaq's website at www.compaq.com or you may call Compaq's Technical Support Center. Compaq's highly trained technicians will first try to resolve the problem through our online services or by telephone. If your problems cannot be resolved using these methods, Compaq will ship an exchange printer to you. Upon receipt of the exchange printer, remove the ink cartridges and cable from the printer you are returning. You will need to use these with your exchange printer. Cable and ink cartridges are not shipped with the exchange printer.

How do I obtain online support?

Compaq offers free technical support via its Internet web site at www.compaq.com. Select Support. You may also visit the Compaq Support Forum at forum.compaq.com to quickly receive answers to your Compaq Inkjet Printer questions.

What is not covered by this limited warranty?

- > Product purchased from anyone other than Compaq or a Compaq authorized reseller
- > Product purchased outside the United States or Canada
- > Software products except for obligations specified in the software program license agreement
- > Routine cleaning, or normal cosmetic and mechanical wear
- > Damage from misuse, abuse, or neglect
- > Damage from use outside the product's usage parameters
- > Damage from use of parts not manufactured or sold by Compaq
- > Damage from modification or incorporation into other products
- > Damage from repair or replacement of warranted parts by other than a Compaq authorized service provider
- > Damage to or loss of any programs or data
- > Damage resulting from an act of God

Limited Warranty Statement for the United States and Canada

This One Year Limited Warranty applies in the United States and Canada to Hardware Products manufactured or distributed by Compaq Computer Corporation (Compaq) under the Compaq brand name.

A Compaq Hardware Product is defined as Compaq Inkjet Printer. Contact your Compaq authorized reseller or Compaq if you have any questions about this Limited Warranty. Compaq's obligations with respect to Software distributed by Compaq under the Compaq brand name are set forth in the applicable end-user license agreement. Compaq has no other obligation to repair or replace software under this limited warranty. Non-Compaq Hardware and Software Products are provided on an as is basis. However, non-Compaq manufacturers, suppliers, or publishers may provide their own warranties.

Terms of the Warranty

Compaq warrants that the Hardware Product you have purchased from Compaq or from a Compaq Authorized Reseller is free from defects in materials

Getting Started Guide

or workmanship under normal use during the warranty period. The warranty period commences on the date of purchase. Please retain a copy of your sales receipt. Your sales receipt is your proof of the date of purchase. This warranty extends only to you, the original Purchaser. It is non-transferable. It excludes expendable parts.

During the warranty period, Compaq will, at no additional charge, repair or replace defective parts with new parts or, at the option of Compaq, serviceable used parts that are equivalent or superior to new parts in performance.

All exchanged parts and Products replaced under this warranty will become the property of Compaq. If, after repeated efforts, Compaq is unable to restore the Product to good working order, you are entitled to a refund of the purchase price.

This Limited Warranty is valid only within the United States or Canada, and within the country in which the Hardware Product was purchased.

This Limited Warranty extends only to Products purchased from Compaq or from a Compaq authorized reseller.

This Limited Warranty also does not extend to any Product that has been damaged or rendered defective (a) as a result of accident, misuse, or abuse; (b) as a result of an act of God; (c) by operation outside the usage parameters stated in the Product's User's Guide; (d) by the use of parts not manufactured or sold by Compaq; (e) by modification of the Product; or (f) as a result of service by anyone other than Compaq, a Compaq authorized reseller, or a Compaq authorized service provider. Compaq is not responsible for damage to or loss of any programs or data. Contact your local Compaq authorized service provider for geographic restrictions, proof-of-purchase requirements, response time commitments and other specific on-site service requirements.

EXCEPT AS EXPRESSLY SET FORTH IN THIS WARRANTY, COMPAQ MAKES NO OTHER WARRANTIES, EXPRESSED OR IMPLIED, INCLUDING ANY IMPLIED WARRANTIES OF MERCHANTABILITY

AND FITNESS FOR A PARTICULAR PURPOSE. COMPAQ EXPRESSLY DISCLAIMS ALL WARRANTIES NOT STATED IN THIS LIMITED WARRANTY. ANY IMPLIED WARRANTIES THAT MAY BE IMPOSED BY LAW ARE LIMITED TO THE TERMS OF THIS EXPRESS LIMITED WARRANTY.

Limitation of Remedy

Compaq is not liable for any damages caused by the Product or the failure of the Product to perform, including any lost profits, lost savings, incidental damages, or consequential damages. Compaq is not liable for any claim made by a third party or made by you for a third party.

This limitation applies whether damages are sought, or a claim made, under this warranty or as a tort claim (including negligence and strict product liability), a contract claim, or any other claim. This limitation cannot be waived or amended by any person. This limitation of liability will be effective even if Compaq or an authorized representative of Compaq has been advised by you of the possibility of any such damages. This limitation of liability, however, will not apply to claims for personal injury.

U.S.A. State Laws

Some states do not allow limitation on how long an implied warranty lasts. In such states, the limitations or exclusions of this Limited Warranty may not apply to you. Some states do not allow the exclusion or limitation in incidental or consequential damages for consumer products. In such states, the exclusion or limitation of this Limited Warranty may not apply to you. This Limited Warranty gives you specific legal rights. You may also have other rights that may vary from state to state. You are advised to consult applicable state laws for a full determination of your rights.

Getting Started Guide

Notices

This section contains information about:

- Notices
- Safety information

Electronic emission notices

Federal Communications Commission (FCC) compliance information statement

This equipment has been tested and found to comply with the limits for a Class B digital device, pursuant to Part 15 of the FCC Rules. Operation is subject to the following two conditions: (1) this device may not cause harmful interference, and (2) this device must accept any interference received, including interference that may cause undesired operation.

The FCC Class B limits are designed to provide reasonable protection against harmful interference in a residential installation.

This equipment generates, uses and can radiate radio frequency energy and, if not installed and used in accordance with the instructions, may cause harmful interference to radio communications. However, there is no guarantee that interference will not occur in a particular installation. If this equipment does cause

harmful interference to radio or television reception, which can be determined by turning the equipment off and on, the user is encouraged to try to correct the interference by one or more of the following measures:

- Reorient or relocate the receiving antenna.
- Increase the separation between the equipment and receiver.
- Connect the equipment into an outlet on a circuit different from that to which the receiver is connected.
- Consult your point of purchase or service representative for additional suggestions.

The manufacturer is not responsible for any radio or television interference caused by using other than recommended cables or by unauthorized changes or modifications to this equipment. Unauthorized changes or modifications could void the user's authority to operate this equipment.

To assure compliance with FCC regulations on electromagnetic interference for a Class B computing device, use a properly shielded and grounded cable. Use of a substitute cable not properly shielded and grounded may result in a violation of FCC regulations.

Any questions regarding this compliance information statement should be directed to:

Compaq Computer Corporation
P. O. Box 692000
Mail Stop 510101
Houston, TX 77269-2000
Or, call (281) 514-3333

Service and Support

Please refer to your Limited Warranty Statement for information on how to obtain service and support for your product.

Industry Canada compliance statement

This Class B digital apparatus meets all requirements of the Canadian Interference-Causing Equipment Regulations.

Avis de conformité aux normes d'Industrie Canada

Cet appareil numérique de la classe B respecte toutes les exigences du Règlement sur le matériel brouilleur du Canada.

Getting Started Guide

European Community (EC) directives conformity

This product is in conformity with the protection requirements of EC Council directives 89/336/EEC and 73/23/EEC on the approximation and harmonization of the laws of the Member States relating to electromagnetic compatibility and safety of electrical equipment designed for use within certain voltage limits.

A declaration of conformity with the requirements of the Directive has been signed by the assigned parties within Compaq Computer Corporation.

This product satisfies the Class B limits of EN 55022 and safety requirements of EN 60950.

Japanese VCCI Notice

この装置は、情報処理装置等電磁障害自主規制協議会（VCCI）の基準に基づきクラスB情報技術装置です。この装置は、家庭環境で使用することを目的としています。この装置がラジオやテレビジョン受信機に近接して使用される場合、受信機を干渉することがあります。取扱説明書に従って正しい取り扱いをして下さい。

The United Kingdom Telecommunications Act 1984

This apparatus is approved under the approval number NS/G/1234/J/100003 for the indirect connections to the public telecommunications systems in the United Kingdom.

Energy Star



The EPA ENERGY STAR Computers program is a partnership effort with computer manufacturers to promote the introduction of energy-efficient products and to reduce air pollution caused by power generation.

Companies participating in this program introduce personal computers, printers, monitors, or fax machines that power down when they are not being used. This feature will cut the energy used by up to 50 percent. Compaq is proud to be a participant in this program.

As an Energy Star Partner, Compaq Computer Corporation has determined that this product meets the Energy Star guidelines for energy efficiency.

Power supply information

If your power supply fails, replace it only with the Compaq replacement part.

Safety information

- > If your product is NOT marked with this symbol , it MUST be connected to an electrical outlet that is properly grounded.
- > The power cord must be connected to an electrical outlet that is near the product and easily accessible.
- > Refer service or repairs, other than those described in the operating instructions, to a professional service person.
- > This product is designed, tested, and approved to meet strict global safety standards with the use of specific authorized components. The safety features of some parts may not always be obvious. The printer manufacturer is not responsible for the use of other replacement parts.

www.compaq.com



232759-001

Free Manuals Download Website

<http://myh66.com>

<http://usermanuals.us>

<http://www.somanuals.com>

<http://www.4manuals.cc>

<http://www.manual-lib.com>

<http://www.404manual.com>

<http://www.luxmanual.com>

<http://aubethermostatmanual.com>

Golf course search by state

<http://golfingnear.com>

Email search by domain

<http://emailbydomain.com>

Auto manuals search

<http://auto.somanuals.com>

TV manuals search

<http://tv.somanuals.com>