

A Proposal for New  
Presentations

## *Intelligent Projector*

---

**User's Manual**

---

# **iP-25E**

***English***

*Deutsch*

*Français*

*Español*

*Italiano*

*中国語*

*한국어*

Thank you for your purchase of an AVIO product.  
 Please read this manual carefully in order to use the projector properly.  
 After reading this, please keep it in a safe place together with the warranty sheet.

## Features of the iP-25E

- **Very versatile five-in-one projector. A projector for the multimedia age.**
  1. *Projection of documents, catalogs, and other printed materials. Printed materials can be projected directly without the creation of OHP film.*
  2. *Projection of personal computer screen images  
Detailed presentations can be made using a personal computer.*
  3. *The video images of video tape decks, DVDs and other equipment can be projected. This permits the creation of presentations that are visually appealing.*
  4. *Projection images can be imported to a personal computer connected via USB.*
  5. *An image that has been scanned to a personal computer can be written on as one pleases using a tablet or another device and while doing so the image can be projected.*
  
- **Easily understood, simple operation for everyone**  
 One button operation simply switches the projection of printed material, personal computer screen, and video image.
  
- **Designed for a conservation of resources which offers excellent cost performance**  
 The creation of OHP film is not required. This allows a reduction of wasteful time and costs.
  
- **Super-thin, stylish body**  
 The iP-25E features a super-thin body for a projector having a built-in OHP function which reflects the advanced technology inherent in the design. Offers an easy fit when in use or when stored.
  
- **Expressive color pictures**  
 High resolution, 2 million pixel CCD camera is built in. It provides faithful and clear reproduction of the detailed neutral tones of color documents with its full-color 16.77 million colors.
  
- **Enlarged display without changing the screen size**  
 When projecting documents having small characters that were not created for presentations, such as catalogs and word-processed documents, the iP-25E can enlarge the document without changing the screen size to provide an easy-to-view display.
  
- **Provided with display functions for compressed or enlarged PC screen**  
 Screens of resolution more than 1024 × 768 dots are displayed compressed to 1024 × 768 dots without any loss in character quality. Such as 640 × 480 resolution screens can also be enlarged to 1024 × 768 dots.



## About Trademarks

IBM and PC/AT are trademarks or registered trademarks of International Business Machines Corporation.  
 Macintosh and Power Book are trademarks of Apple Computer Inc.  
 Windows is a trademark of U.S. Microsoft Corporation.

## Warnings and Safety Precautions

### Warning Symbols

To alert the user to important safety precautions, the following symbols are used in this manual and on the product. Make sure you understand what these symbols mean before operating the projector.

 <b>WARNING</b>	Death or serious injury may result if this warning is ignored.
 <b>CAUTION</b>	Injury or damage to the equipment may result if this warning is ignored.
<b>NOTE</b>	This indicates an item that you should take care of when handling your projector.
	This symbol alerts the user to high voltage that could cause electric shock.

# Safety Precautions

---

## **WARNING**

- **If a fault occurs:**
  - If you detect smoke, or a strange smell or sound, immediately disconnect the power cable.  
It is dangerous to continue using the projector after a fault occurs. Return the projector to the dealer where it was purchased for repair.
- **Avoid placing the projector near dangerous substances.**
  - Make sure that no metallic or flammable material can get into the projector through the air vents.
  - Do not place any objects containing water on top of or next to the projector.
- **If foreign matter gets inside the projector:**
  - If foreign matter such as water or metal gets inside, immediately disconnect the power cable.  
It is dangerous to continue using the projector when foreign matter gets inside. Return the projector to the dealer where it was purchased for servicing.
- **Do not remove the cabinet.**
  - Do not remove the cabinet. There are high-voltage components inside and touching these parts could cause electric shock, or damage the equipment.
- **Handle the power cable safely.**
  - Do not place any heavy objects on top of the power cable.  
Damage to the power cable can cause wire breakage, fire, or electric shock.
  - Do not pull the power cable when disconnecting the power plug.  
Pulling the cable may break the wires or cause fire or electric shock. Always hold the plug itself when pulling it out of the power outlet.
  - Do not damage the power cable. If the power cable is damaged (e.g. the core is exposed or cut), contact the sales office of purchase. (charged) it could cause fire or electric shock if you continue using the damaged power cable.
- **Do not peep into the lens.**
  - Do not peep into the lens of the projector during operation. The powerful rays passing through the lens could damage the eyes.
- **Do not put the projector in unstable places.**
  - Do not put the projector in unstable places such as on unstable desks or slopes.  
Doing so could cause the projector to drop or turn over, resulting in injury.
- **Do not use any voltages other than specified.**
  - Do not use any voltages other than specified. Doing so could cause fire or electric shock.
- **Do not beat the glass surface**
  - Do not beat the glass surface over the scanner. Doing so may break the glass, resulting in injury.
- **Do not touch the air vents or lamp cover**
  - The air vents, lamp cover, and peripheral surfaces may be high temperature during operation or just after the light is turned off.  
Do not touch those for a long time.
- **Do not block the lens front**
  - Do not block the lens front during operation.  
The powerful rays passing through the lens may cause fire or burns if you put anything in front of the lens or block the lens with your hand during operation.

### **CAUTION**

#### • **Installation**

- Avoid installing the projector in places where it may be exposed to:
  - Strong vibrations
  - Soot or steam
  - Direct sunlight or near a heater (35°C/95°F or higher)
  - High humidity or dust
  - Extreme cold (0°C/32°F or lower)
  - Strong magnetic or electric field generated from a nearby appliance
  - Wobbling on an unstable surface

#### • **Do not block the air vents.**

- Do not block the air vents with cloth or an object.

When you put anything around the unit, be sure to ensure a space of 10 cm/4 inches or more between the unit and the air vent. Be sure to prevent paper or cloth from blocking the air vent at the bottom of the unit. If blocked, the internal temperature may increase, resulting in malfunctions.

#### • **Do not bump the projector.**

- Avoid bumping the projector when moving or handling. Shocks can cause damage.

#### • **Care of the projector**

- To prevent risk of accidents, always disconnect the power plug before cleaning the projector.
- Clean the lens surface with a commercial blower or lens cleaning paper.  
Wiping with tissue paper or a handkerchief can damage the lens.
- To clean the cabinet, operation panel, and glass surface, wipe gently with a soft cloth. For particularly dirty spots, soak the cloth in a neutral detergent mixed in water, wring out well and wipe off the dirt, then use a dry cloth to wipe dry.
- Do not wipe the projector with any volatile solvent such as benzine or thinner.  
Solvents can cause surface deformation or flaking of the paint.  
If using an impregnated cloth, follow the instructions of the cloth.

#### • **Avoid scratching the glass surface.**

- Take care not to scratch the glass surface of the scanner with hard or pointed objects.  
Scratches on the glass may distort the projected image.

#### • **Battery**

- When inserting battery in the remote control, note the polarity (plus and minus signs) and insert correctly as indicated. Inserting a battery in a wrong direction can cause rupture or leakage, and could result in fire and injury or soil the surrounding area.
- Do not use coin battery other than the type specified for the equipment. Incorrect battery usage could result in rupture or leakage, and could cause fire and injury.
- Do not heat, break open, burn, or immerse the battery. Battery rupture or leakage could cause fire and injury.

#### • **Servicing and cleaning**

- Have the internal components cleaned by a retailer about once a year. There is a risk of fire or faulty operation if the inside of the projector gets dusty and is not cleaned for a long time. For best results, the projector should be serviced before the wet season brings damp conditions. Cleaning charges are at the discretion of the retailer.

#### • **If not using the projector for a long period:**

- If you do not plan to use the projector for a long time, disconnect the power cord for safety.

#### • **Disposal**

- Follow the recommendations of your local authority when disposing of the projector.

#### • **Transporting the projector**

- Use the special packaging when transporting the projector. The manufacturer cannot accept responsibility in the event of damage or accident if other packaging is used.
- Use the special packaging no more than two times. Repeated usage reduces the shock absorbency of the packaging and can lead to damage or accident.
- Contact the retailer if you require new packaging.

- **Lamp implosion**

- A DC type Super High pressure lamp is used in this projector and it is rare for the lamp to explode during use. The unit is also designed to forcibly turn off the lamp because there is a high possibility that the lamp will break if it is used beyond the lamp usage of 2000 hours (Refer to pages E-42 and E-44).

- **Note the following things**

- A sound occurs because the internal pressure of the Super High pressure lamp gets extremely high. The unit is designed so that no pieces of glass come out of it when the lamp explodes.
- However, the gas inside of the lamp can escape and looks like white smoke. It will not cause any fire.

- **Remedy**

- If a lamp explodes in a product, there will be pieces of lamp inside. Do not replace the lamp. Return the product to the sales office or agent of purchase. Even though the lamp has exploded, never try to replace the lamp by yourself. The lamp pieces could cause injury.

- **Replacing the lamp**

- Be sure to turn the lamp off and disconnect the power cable when the fan stops, and wait an hour or more before replacing the lamp. Replacing the lamp during operation or just after the power is turned off may cause burns due to heat. Refer to "Replacement of the Lamp Unit" on page E-42 for the procedure.

- **Replacing / cleaning the air filter**

- Be sure to disconnect the power cable when the cooling fan stops before removing the air filter. Removing the air filter while the cooling fan is rotating could cause an accident. Refer to "Cleaning the Air Filter" on page E-45 for the procedure.

- **Avoiding malfunctions and accidents**

- Adjust the Adjustable feet to keep the projector horizontally. Using the projector in a tilted status may cause injury if it rolls over. Refer to "Adjusting the Tilt" on page E-22 for the adjusting procedure.

- **Do not do the followings**

- Do not put anything heavy on the projector.
- Do not step on the projector, rack, or stand. Do not hold or hang on the projector. Doing so could cause the projector to roll over or break, resulting in injury. Especially be careful if small children are near.
- Do not use the rack unless the casters are locked when placing the projector on a rack with casters. Doing so may cause the projector to move or roll over, resulting in injury.
- Do not turn the lamp on/off within one minute after it is turned off/on. Extremely high voltage is generated in the lamp just after it is turned on. Turning the lamp on/off too frequently could cause the lamp to deteriorate or break, resulting in malfunctions of the projector.
- Do not project an image with the lens cap attached.

- **Moving the projector**

- Be sure careful of the glass surface at moving the projector while holding the handles.
- If the document cover is not inserted enough, it may get loose and fall off while you carry it.

- **Care of the power cable and plug**

- Do not put the power cable near a heater. Doing so could cause the sheath of the cable to melt down, resulting in fire or electric shock.
- Do not connect or disconnect the power cable with wet hands. Doing so could cause electric shock.
- Be sure to pull out the power cable and disconnect any cable connections between units and release the anti-theft lock before moving the projector. Moving the projector with cables connected may cause fire or electric shock if the cables are damaged.
- If you do not plan to use the projector for a long time, disconnect the power cable for safety.

- **DO NOT REMOVE ANY SCREWS except the lamp cover screw and two lamp unit screws. Otherwise you could receive an electric shock.**

- **Light Polarizing Element**

Light polarizing elements such as the light source lamp and the liquid crystal panel are parts that have a service life. When used for a long time, repair and replacement will be necessary. Please contact a customer support center for details.

# Table of Contents

---

<b>Safety Precautions</b> .....	<b>E-3</b>	<b>Method of OHP Operation</b> .....	<b>E-30</b>
<b>A Check of the Supplied Items and the Names of the Parts</b> .....	<b>E-7</b>	Attaching the Document Cover .....	E-30
Supplied Parts Check .....	E-7	Preparation of the Projection Document .....	E-30
Names and Functions of the Parts (Projector) .....	E-8	Reading Size of Projection Documents .....	E-30
Names and Functions of the Parts (Input Connectors) .....	E-10	<b>Menu Configuration</b> .....	<b>E-31</b>
Names and Functions of the Parts (Operation Panel) .....	E-11	<b>Menu Operation Method</b> .....	<b>E-32</b>
Names and Functions of the Parts (Remote Control) .....	E-12	Names and Functions of the Buttons Used in Menu Operation .....	E-32
Operation of the Remote Control .....	E-13	Names and Functions of the Menu Parts .....	E-32
Battery Replacement .....	E-13	Method of Menu Operation .....	E-33
<b>Procedure Up to Projection</b> .....	<b>E-14</b>	<b>Menu Description</b> .....	<b>E-35</b>
<b>Projection Distance and Screen Size</b> .....	<b>E-15</b>	Pointer • Screen .....	E-35
<b>Connections with the Personal Computer</b> .....	<b>E-16</b>	Image adjustment .....	E-36
Basic Connections .....	E-16	Settings .....	E-38
Connections with Personal Computers .....	E-16	<b>Maintenance</b> .....	<b>E-40</b>
Personal Computer Input Connector .....	E-17	Fault Protection .....	E-40
When the Image of the Personal Computer Screen Is Not Projected .....	E-18	Replacement of the Lamp Unit .....	E-42
Table of Supported Input Signals (Personal Computer Video Input Connector) ....	E-19	Cleaning the Air Filter .....	E-45
<b>Connections with Video Equipment</b> .....	<b>E-20</b>	<b>Troubleshooting</b> .....	<b>E-46</b>
<b>Connection of the Power Cable and On/Off Switching</b> .....	<b>E-21</b>	<b>Repair Service</b> .....	<b>E-47</b>
Switch On the Power .....	E-21	<b>Specifications</b> .....	<b>E-48</b>
Switch Off the Power .....	E-21		
<b>Adjustment of the Projection Image</b> .....	<b>E-22</b>		
Adjusting the Projection Image .....	E-22		
Making Focus/Zoom Adjustments .....	E-22		
Adjusting the Tilt (Slant) .....	E-22		
<b>Regular Operation</b> .....	<b>E-23</b>		
Select the Input .....	E-23		
Changing the Orientation of the Projection Image .	E-23		
Enlarging and Reducing the Projection Image .....	E-24		
Adjusting the Brightness .....	E-25		
Capturing the Projection Image/ Still Image Display .....	E-26		
Viewing OHP History Images .....	E-27		
Transferring Captured Images .....	E-28		
Adjusting the Volume .....	E-28		
Displaying the Pointer .....	E-29		
Deleting the Projection Image and Audio .....	E-29		

# A Check of the Supplied Items and the Names of the Parts

## Supplied Parts Check

Please check that the supplied parts are included.

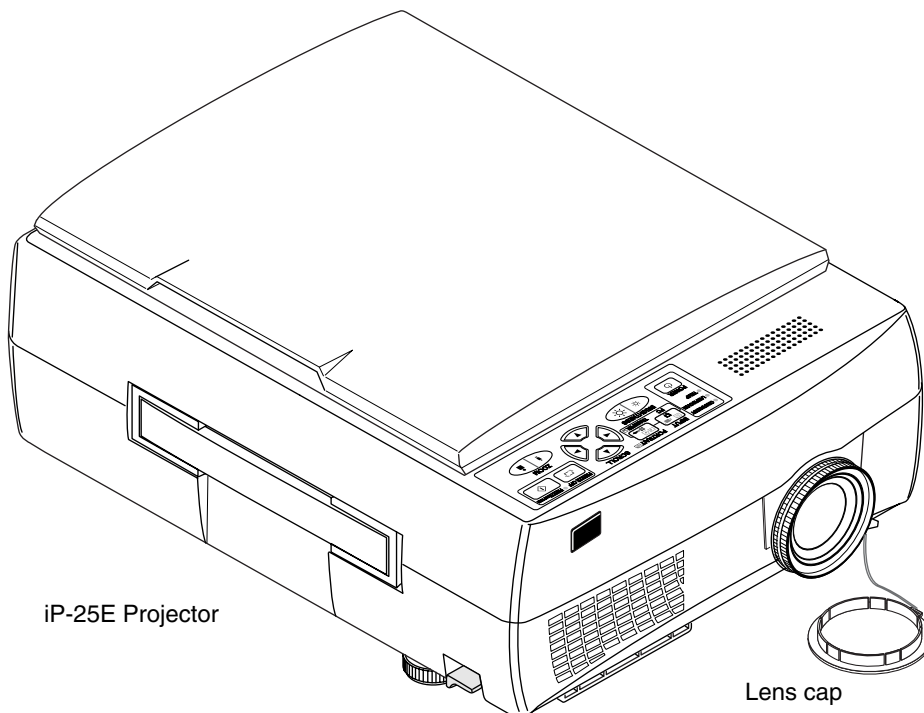

iP-25E Projector

Lens cap

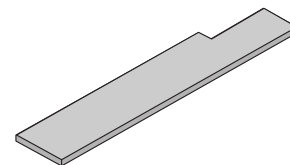

Replacement air filter

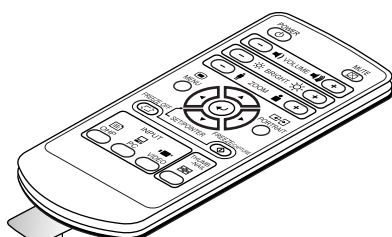

Pull out the sheet before use.

Remote control

Coin-type lithium battery: CR2025  
(Inside the remote control)

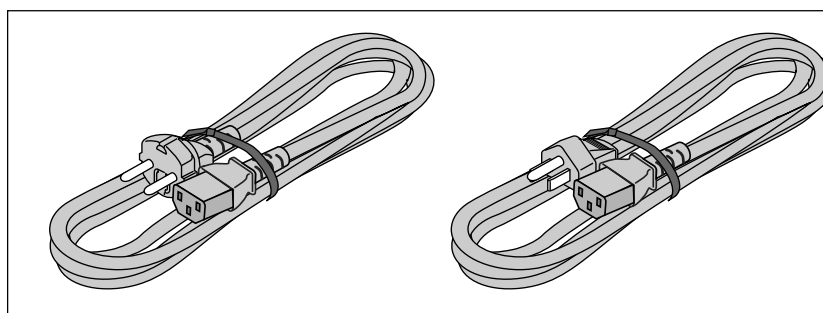

Power cable (3 m)

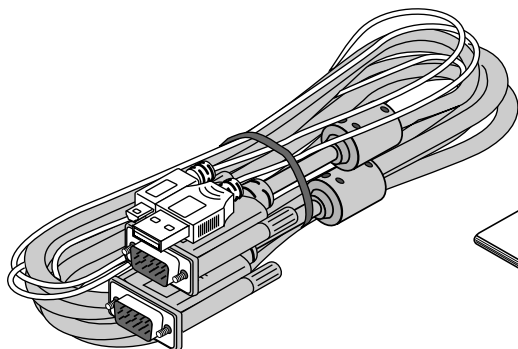

PC connection cable (2 m)

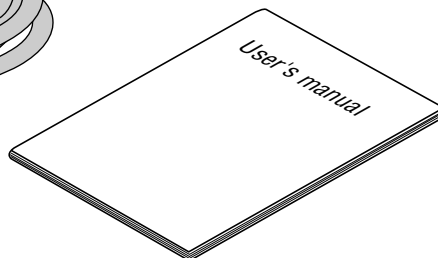

iP-25E User's Manual

## Names and Functions of the Parts (Projector)

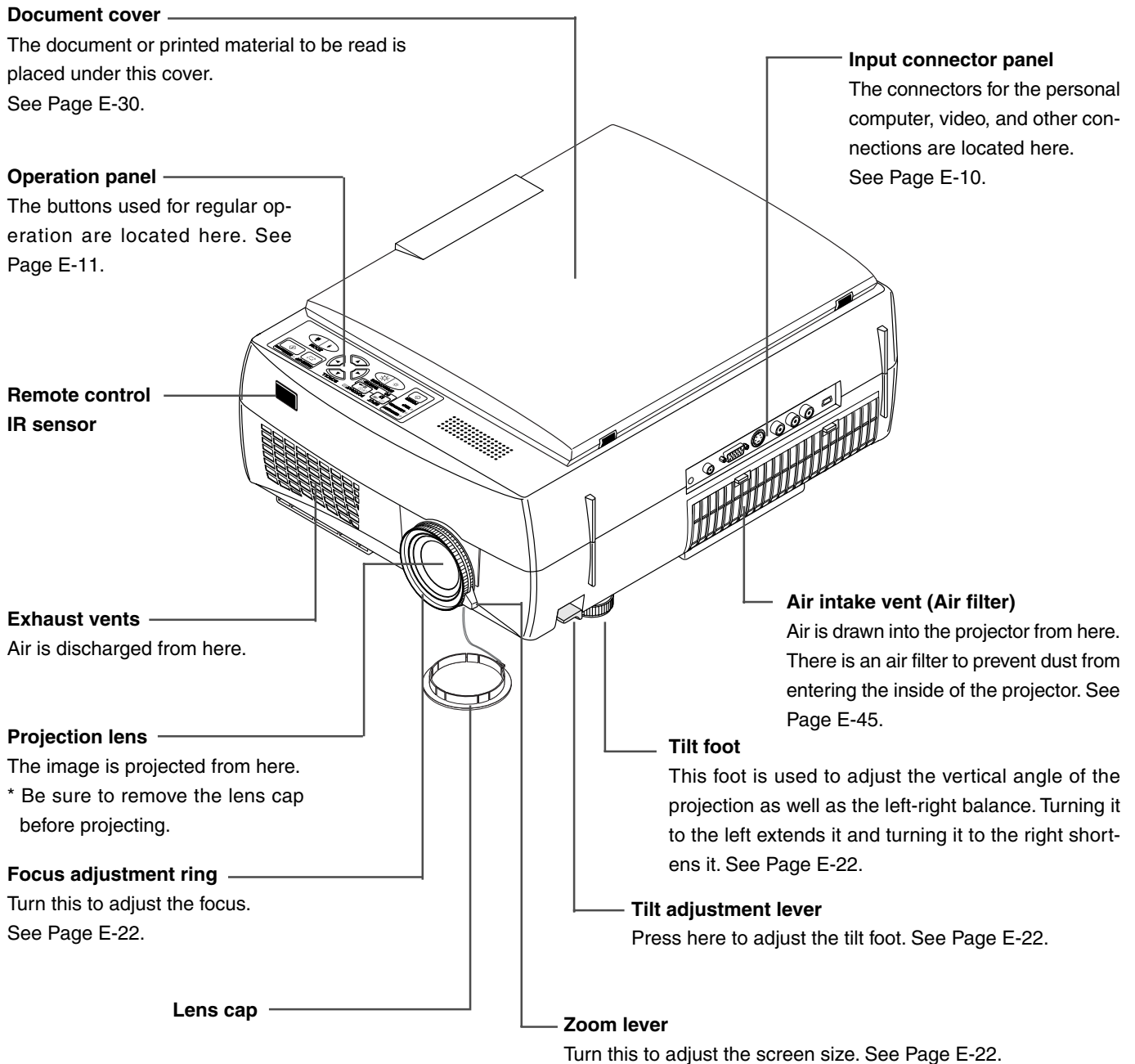



**Document reading area**

The document or printed material that you wish to project in the OHP mode is placed here.  
See Page E-30.

**Speaker**  
(2 W, monaural)

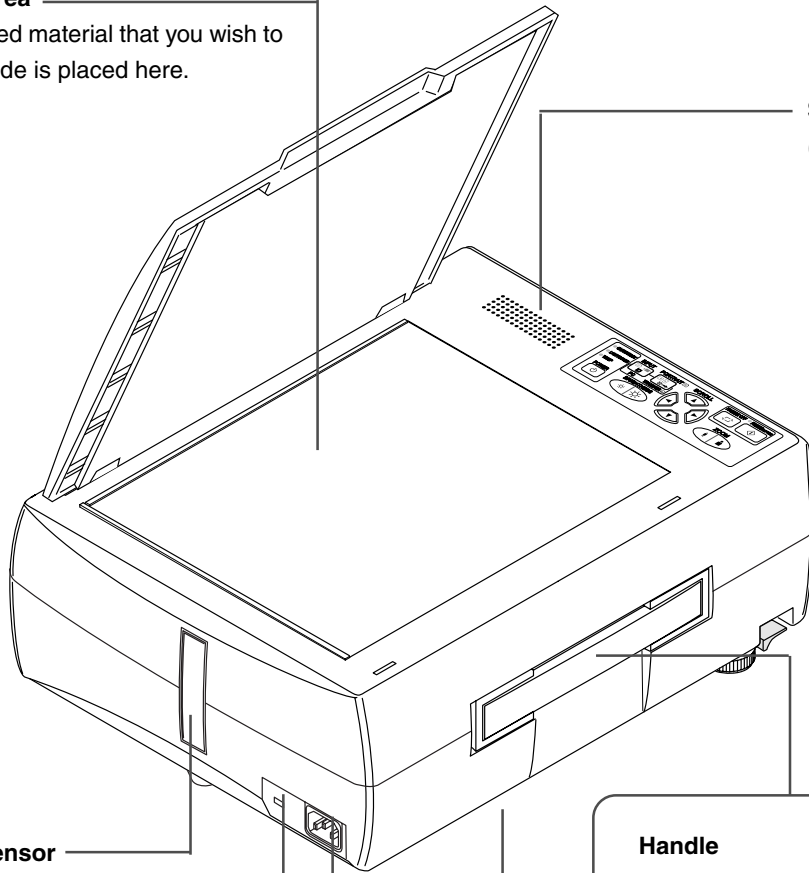

**Remote control IR sensor**

**Theft prevention lock**  
Please see the Note below.

**Power input connector**  
Plug in the power cable here. See Page E-21.

**Lamp unit cover (Underneath projector)**  
The projection lamp unit is located inside.  
See Page E-42.

**Handle**

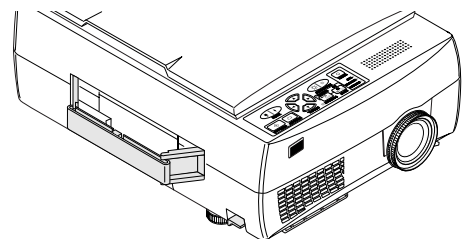
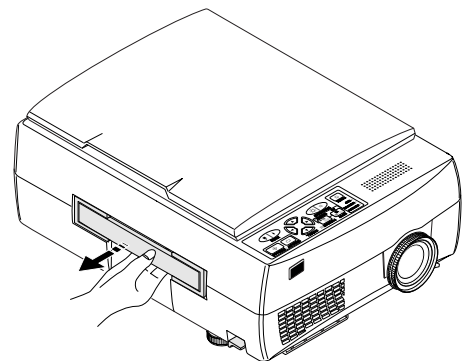

**NOTE**

**About the anti-theft lock**

The anti-theft lock is compatible with Kensington security cable lock.  
Contact the following for more information about the products.

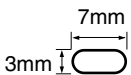

Kensington Technology Group  
2000 Alameda de las Pulgas  
Second Floor  
San Mateo, California 94403-1289, U.S.A.  
Phone: (650) 572-2700  
Fax: (650) 572-9675  
URL: <http://www.kensington.com>

## Names and Functions of the Parts (Input Connectors)

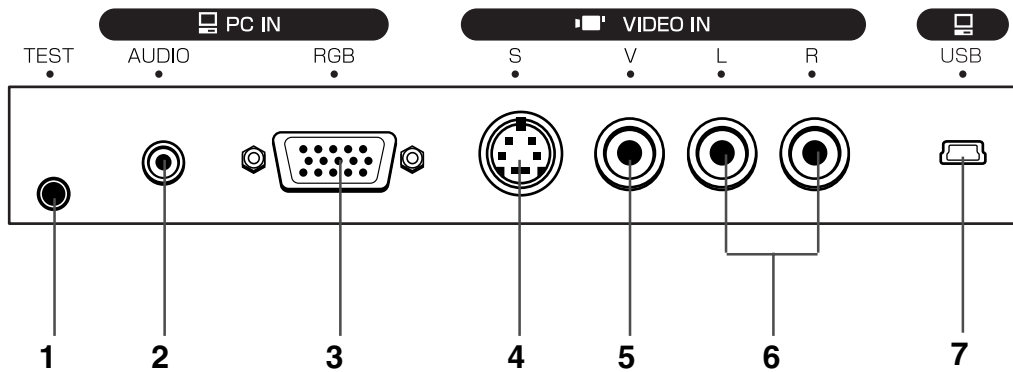

### 1. Test (maintenance) connector

This special connector is used at the time of maintenance and factory tests. It cannot be used for other connections.

### 2. Personal computer audio input connector

This audio input connector is for use with the personal computer (Stereo supported). See Page E-16.

### 3. Personal computer video input connector

This input connector is for use with the analog RGB of the personal computer. See Page E-16.

### 4. S-video input connector

This input connector is for use with the (Y/C) video. See Page E-20.

### 5. Video input connector

This input connector is for use with the video (NTSC / PAL / SECAM). See Page E-20.

### 6. Audio input connectors for the video

Audio input connectors for use with the video. (Stereo supported)  
See Page E-20.

**NOTE:** The sound of the left and right channels is output from the monaural speaker.

### 7. USB connector

This connector is used for USB connections with a personal computer.

## Names and Functions of the Parts (Operation Panel)

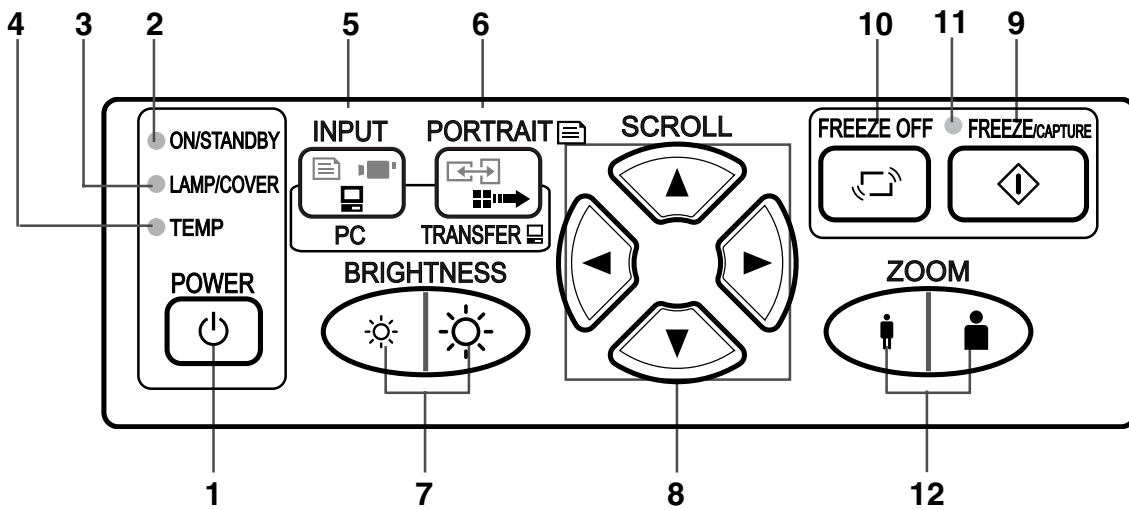

### 1. POWER Button

Switches the power of the projector on or off (standby mode).

- Only this button is effective when the projection lamp is off.

See Page E-21.

### 2. ON/STANDBY LED

Lit red during standby and lit green when the projection lamp is on. See Page E-21.

### 3. LAMP/COVER LED

Lit green during projection. Lit red when the air filter or lamp unit cover is not in place.

- At the time of the projection lamp lighting operation, the LED flashes for about 6 seconds and then lights green.
- At the time of a projection lamp lighting failure, the LED flashes green. (The flashing interval when the projection lamp is off will be longer than when the LED flashes at other times.)
- When the projection lamp is off, the LED flashes green for 60 seconds and then goes off.
- When the projection lamp has been used in excess of 1,900 hours, the LED flashes red; when use exceeds 2,000 hours the LED is lit a steady red.

See Page E-40.

### 4. TEMP LED

When the internal temperature has risen excessively, the LED flashes red for 10 seconds, then is lit a steady red. See Page E-40.

### LED List

LED State			Significance	
ON/STANDBY	LAMP/COVER	TEMP		
Off	Off	Off	AC power OFF	Normal condition
Red	Off	Off	Standby	
Green	Flashing green	Off	Standby to start of projection End of projection to standby	
Green	Green	Off	Projecting	
Red	Red	Off	Fan cover open	Power has been switched OFF because of the alarm
			Lamp cover open	
			Lamp burned out	
			Lamp usage exceeds 2,000 hours	
Red	Off	Red	Temperature fault	Alarm sounding
			Fan fault	
Green	Flashing red	Off	Lamp usage exceeds 1,900 hours	Alarm sounding
Green	Green	Flashing red	Abnormal temperature warning	

### 5. INPUT SELECT Buttons

These buttons select the input source.  
OHP → PC → VIDEO → OHP →...

See Page E-23.

### 5. PORTRAIT/TRANSFER Button

**During OHP selection:** Changes the orientation of the projection screen. Changed screens are displayed in conjunction with the width. See Page E-23.

**During PC selection:** When a USB cable is connected, the images stored internally are transferred to the personal computer. See Page E-28.

### 7. BRIGHTNESS Buttons

These buttons adjust the brightness of the projection screen.  
See Page E-25.

### 8. SCROLL Buttons

Sets the selection of the item or the adjustment value at the menu screen. Moves the zoom position during a zoom display. Moves the pointer when the pointer is being displayed.  
See Pages E-23, 24, 27 and 29.

### 9. FREEZE/CAPTURE Button

Makes the projection screen image into a still image. In the OHP mode, the image is stored in internal memory as a thumbnail.  
See Page E-26.

### 10. FREEZE OFF Button

Cancels the still image mode.  
This is used when checking the projection screen while moving the document.  
See Page E-27.

### 11. FREEZE LED

This LED is lit green during the still image display and is lit orange at the time the display is frozen (or captured). The LED goes off when the still image condition is cancelled.

### 12. ZOOM Buttons

These buttons adjust the magnification of the projection screen. See Page E-24.

## Names and Functions of the Parts (Remote Control)

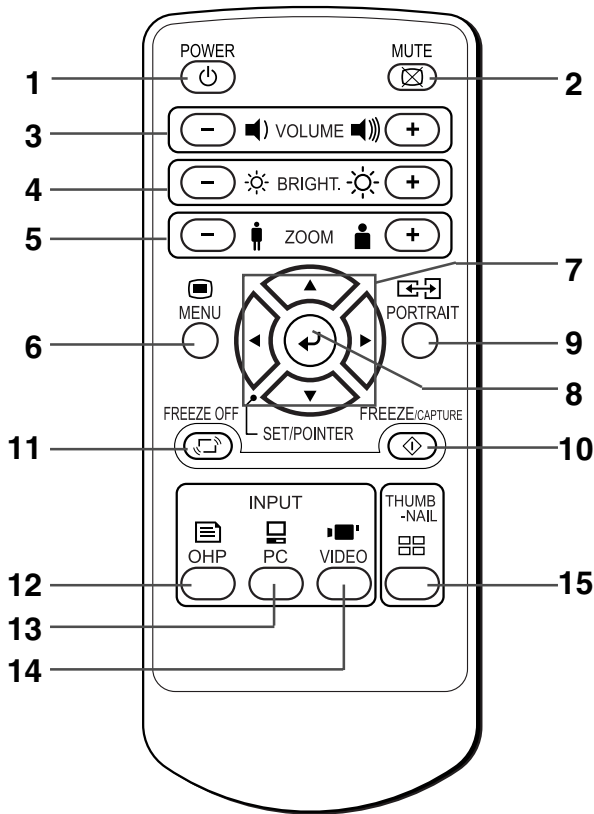

### 1. POWER Button

Switches the power of the projector on or off (standby mode).

- Only this button is effective when the projection lamp is off.

See Page E-21.

### 2. MUTE Button

Temporarily blanks the projection screen without switching off the lamp. One more press causes the screen to return immediately.

See Page E-29.

### 3. VOLUME Buttons

These buttons adjust the volume when the PC or video is selected.

See Page E-28.

### 4. BRIGHTNESS Buttons

These buttons adjust the brightness of the projection screen.

See Page E-25.

### 5. ZOOM Buttons

These buttons adjust the magnification of the projection screen.

See Page E-24.

### 6. MENU Button

Switches on or off the display of the menu screen.

See Page E-32.

### 7. SCROLL Buttons

Sets the selection of the item or the adjustment value at the menu screen. Moves the zoom position during a zoom display. Moves the pointer when the pointer is being displayed.

See Pages E-23, 24, 27 and 29.

### 8. SET/POINTER Button

During menu display, this button advances the menu to the next level. This button finalizes the setting at the time of item selection. See Pages E-29 and 32. This button displays a pointer when the menu screen is not displayed. Press this button one more time to make the pointer disappear.

### 9. PORTRAIT Button

Selects the orientation of the projection screen. The display of the switched screen is adjusted to match the width.

See Page E-23.

### 10. FREEZE/CAPTURE Button

Makes the projection screen image into a still image. In the OHP mode, the image is stored in internal memory as a thumbnail.

See Page E-26.

### 11. FREEZE OFF Button

Cancels the still image mode.

This is used when checking the projection screen while moving the document.

See Page E-27.

### 12. OHP Button

Switches the projector to OHP input. See Page E-23.

### 13. PC Button

Switches the projector to PC input. See Page E-23.

### 14. VIDEO Button

Switches the projector to video input. See Page E-23.

### 15. THUMBNAIL Button

Displays the captured still image as a thumbnail.

See Page E-27.

## Operation of the Remote Control

- Please use the remote control within a range of about 7 m from the remote control IR sensor of the projector (located at both the front and rear) and within an angle of 10 degrees to the left and 10 degrees to the right. Note that this distance may be shorter depending on battery consumption.
- The remote control will not function when there is an obstacle located between the remote control and the remote control IR sensor of the projector.

## Battery Replacement

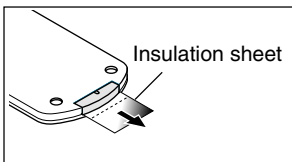

### Before Using the Projector

An insulation sheet has been inserted for protection during transportation prior to shipping. Please pull out and remove the sheet before use.

- 1** Firmly hold the remote control with your hand and insert the tip of a ballpoint pen or some other pointed object into the hole on the rear side.

Note that there is the risk of scratching the case when using a pointed item such as an awl.

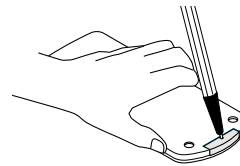

- 2** Slide the battery holder toward you by pressing from above with the pointed item, then remove the holder.

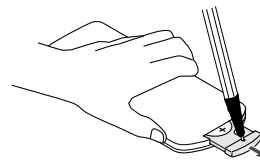

- 3** Insert the battery with the + side facing up as illustrated on the inside of the case.



- 4** Return the battery holder to its original state.

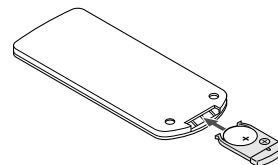

### ⚠ CAUTION

#### Handling of the Remote Control

- Do not subject the remote control to a strong shock such as dropping it from a table. Doing so could damage it and render it inoperable.
- Do not expose it to water or other liquid. If the remote control becomes wet, wipe it dry immediately.
- Avoid exposure to heat and steam. Remove the coin-type lithium battery when the remote control will not be used for an extended period.
- Do not disassemble or heat the coin-type lithium battery, nor throw it into a fire.
- Please follow the disposal method of your region in disposing of the used coin-type lithium battery.
- The remote control may fail to operate or performance may worsen when it is used near an inverter type fluorescent lamp.
- Please store the coin-type lithium battery in a place that is out of the reach of children. If the battery is swallowed, promptly seek the care of a doctor.
- Please handle the remote control with care, since there are some operations available only with it.

**NOTE:** When it is time to replace the battery, please purchase a CR2025 coin-type lithium battery. The use of batteries having a different shape such as the CR2032 may make removal difficult.

# Procedure Up to Projection

---

## 1 Consideration of placement location and screen size

Determine the screen and projector setup location.

Set the projector on a strong and stable, level platform.

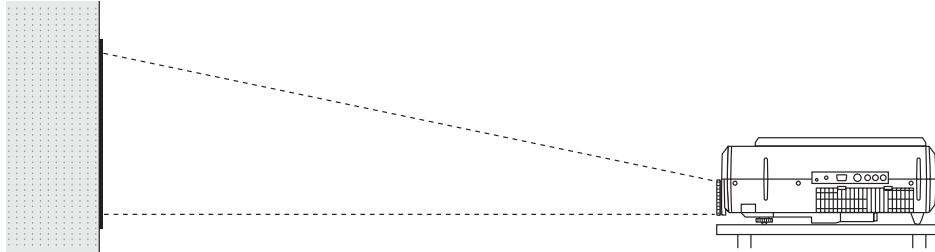

See Page E-15 for information about the projection distance and screen size.

## 2 Connections with input equipment

Connect your personal computer/video equipment.

Connections with the Personal Computer → See Page E-16

Connections with the Video Equipment → See Page E-20

## 3 Connect the power cable and switch on the power

Switch On the Power → See Page E-21

Switch Off the Power → See Page E-21

## 4 Switch on the power of the personal computer or video equipment

## 5 Properly adjust the projection image to the screen

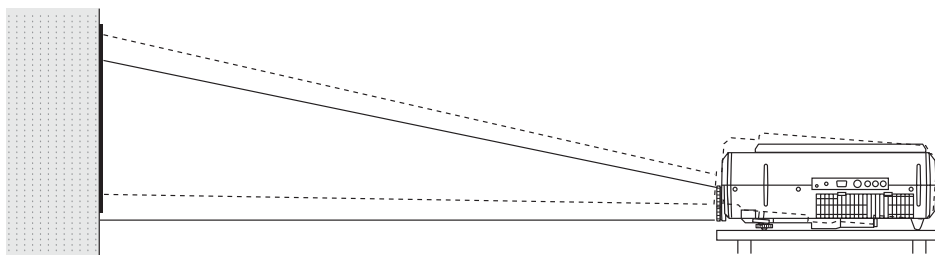

→ See Page E-15

### Perform the tilt adjustment of the projector to provide the desired projection height.

The tilt adjustment allows the position of the projection image to be raised and lowered. The adjustment angle is from 0 degrees to 7 degrees.

Tilt adjustment → See Page E-22

## 6 Select the input equipment

→ See Page E-23

## 7 Adjust the image or video

Adjust the image to provide the optimum condition, as required.

→ See Page E-36

# Projection Distance and Screen Size

Please use the following diagrams to determine the screen display size and the type of screen required for any given projector location.

Projection distances that will be in focus will be 1.3 m (4.3 feet) to 11.3 m (37.0 feet) from the front of the lens. Please arrange the setup within this range.

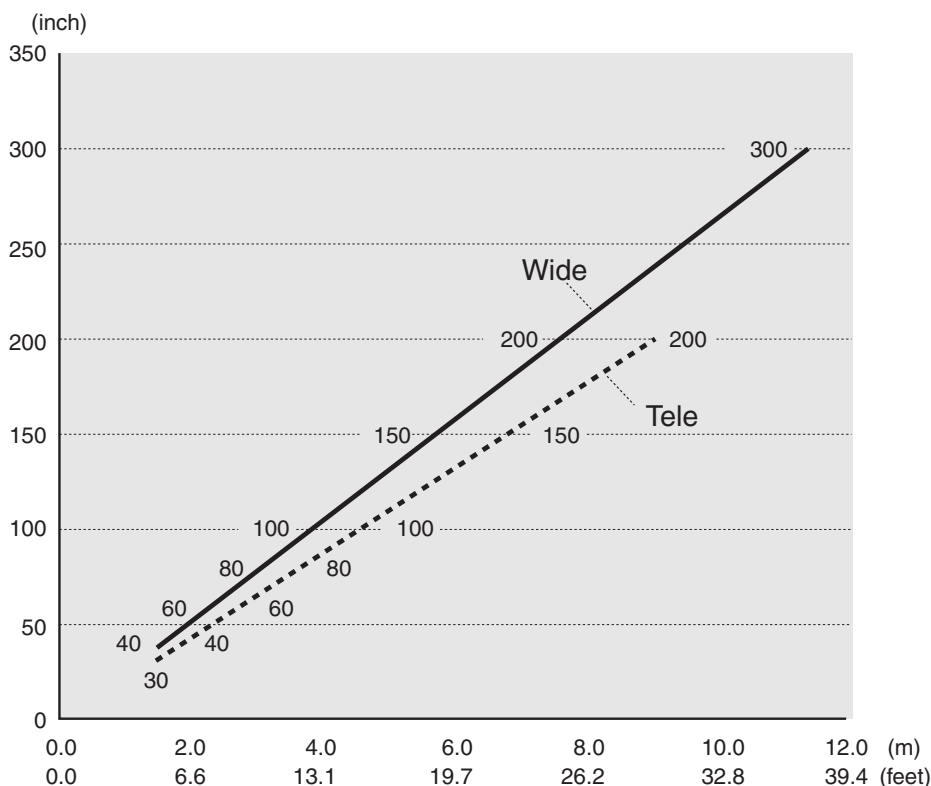

**Projection Distance Table**

Screen Size (Inch Diagonal)	Projection Distance (m)		Projection Distance (feet)	
	Wide	Tele	Wide	Tele
30	—	1.3	—	4.3
40	1.5	1.8	4.9	5.9
60	2.2	2.7	7.2	8.9
80	3.0	3.6	9.8	11.8
100	3.7	4.5	12.1	14.8
150	5.6	6.7	18.4	22.0
200	7.5	9.0	24.6	29.5
300	11.3	—	37.1	—

**Wide:** The size of the projection image becomes maximum with the projection image size adjustment using the zoom lens

**Tele:** The size of the projection image becomes minimum with the projection image size adjustment using the zoom lens

## CAUTION

### Setup Location

- Do not place the projector in locations that will reach high temperatures or low temperatures. Operation ambient temperature: 0°C (32°F) to 35°C (95°F)
- Set the screen so that it is not exposed to direct sunlight or the light of direct illumination. When light hits the screen, the screen show a white cast and will be difficult to watch. In a bright room, the curtains should be drawn or blinds closed and the area around the screen kept dark.
- Do not set up the projector in locations exposed to dampness, dust, greasy smoke or tobacco smoke. Doing so will result in the adhesion of dirt to lenses, mirrors, and other optical parts and cause a degradation of image quality.
- Do not place the projector in a location where the ventilation vents will be blocked or in closed areas having poor ventilation. Doing so will cause the temperature to rise and could cause a fire or accident. (The exhaust vents are at the front of the projector and the air intake vents are located at the side.)

# Connections with the Personal Computer

## CAUTION

### Connection Precautions

- To protect this projector and the equipment to be connected, switch off the power of each unit before making connections.
- Please read the various equipment instruction manuals for information about the connection of the equipment and the method of use.
- When connection is made with a notebook computer and the image is displayed on the LCD screen of the notebook computer, a proper display might not be obtained on projection screen. Switching off the display of the notebook computer will result in a proper display. The method of switching off the display of the notebook computer will differ depending on the PC manufacturer. Please read the instruction manual of the notebook computer for details.
- Connection might not be possible depending on the model and settings of the personal computer. Please contact your dealer of purchase for further information.

## Basic Connections

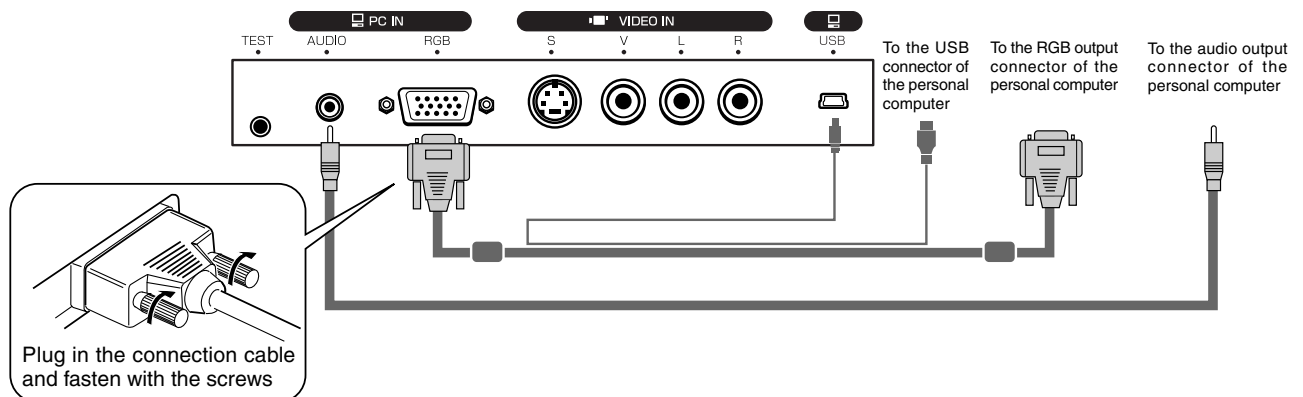

### NOTE:

- Input Connectors → See Page E-10.
- Please see the "iP Viewer Software Program Operating Instructions" for the method of use when there is a USB cable connection.

## Connections with Personal Computers

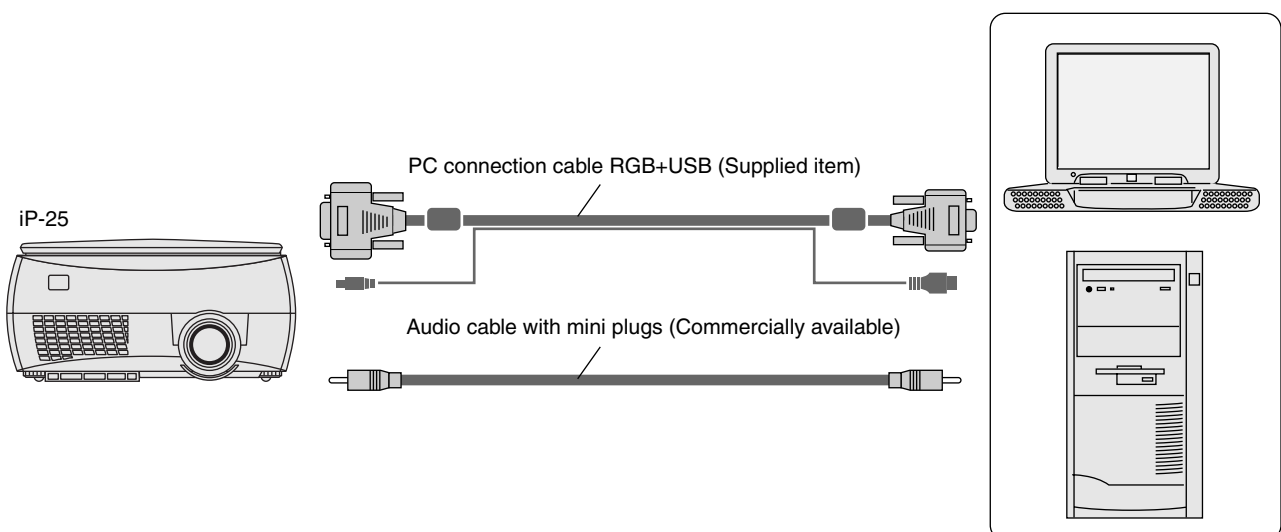

### NOTE:

- After connecting the RGB+USB cable, please set the personal computer external output and screen display.
- When the settings of the external output have not been made, "No signal being input" will be displayed.
- When a condition in which a signal has not been input continues for 15 minutes or longer, the lamp is turned off automatically.



## Connecting Macintosh Computers

- Attach the supplied (RGB+USB) cable if when the monitor output is a VGA port (mini D-SUB 15-pin).
- An optional Apple video adapter cable is required when the monitor output is a video port or DVI port.
- Please do not make a USB connection because iP Viewer does not support the Macintosh.

## Personal Computer Input Connector

### Personal Computer Input Connector

The personal computer input connector uses a 15-pin mini D-SUB type connector.

The pins and their corresponding signal inputs are described below.

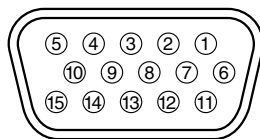

① RED VIDEO	⑥ GND	⑪ NC
② GREEN VIDEO	⑦ GND	⑫ SDA (DDC2B)
③ BLUE VIDEO	⑧ GND	⑬ H.SYNC
④ GND	⑨ NC	⑭ V.SYNC
⑤ NC	⑩ GND	⑮ SCL (DDC2B)

**NOTE:** The RGB (15-pin) input connector of the projector is of the analog type. This cannot be connected with a digital output type of personal computer.

## When the Image of the Personal Computer Screen Is Not Projected

Please check the matters described below when the image of the personal computer is not projected or when there is projection but the image is not correct.

### ● The image is not projected

When the external output signal from the personal computer is not input to the iP-25E, "No signal being input" is displayed on the display screen of the iP-25E. Should this occur, please check the following matters.

#### 1 Try restarting the personal computer.

When the iP-25E is connected after the personal computer has been started, the connection of the iP-25E might not be recognized by the personal computer. When the iP-25E has not been recognized, the external output signal from the personal computer will not be output and there will not be an image to project.

#### 2 Check the functions of the personal computer.

Depending on the notebook computer, some computers will require an operation to output a signal from the external output connector. If this operation is not performed, the external output signal from the notebook computer will not be output. Please see the instruction manual of the notebook computer you are using and perform the operation that will output the signal from the external output connector.

(Operation Example)

##### IBM PC/AT and DOS/V computers:

Press the [Fn] key + "any one of the [F1] to [F12] keys (noting that the operation will differ depending on the model)"

##### PC98 notebook computers later than the Nr Series (with the exception of the PC-98NX):

Press the "Suspend Resume" switch.

#### Correspondence List for Connection Problems with the Personal

Manufacturer	External Output Switching Method	Manufacturer	External Output Switching Method
IBM	Fn+f7	DELL	Fn+f8
NEC	Parallel output	Toshiba	Fn+f5
	Switching from the Task Bar	Panasonic	Fn+f3
	Fn+f3	Fujitsu	Fn+f10
COMPAQ	Fn+f4	Mitsubishi	Fn+f5
Sharp	Fn+f5	Apple	Control panel
SONY	Fn+f7		→ monitor display switching

\* This table indicates the results of an independent investigation by us of representative computers made by various manufacturers; it does not include all of the connections.

\* Company names and product names mentioned are the trade marks or registered trademarks of the respective companies.

### ● The screen of the personal computer is correct, but the image is not projected properly

#### Please check the functions of the personal computer.

Even though the LCD screen of the notebook computer is properly displayed, the projected image might not be projected properly. Due to restrictions of the notebook computer there will rarely be instances in which the setting of a simultaneous display (i.e., simultaneous output of the external output signal while displaying the screen of the personal computer) will result in a signal that greatly deviates from the range supported by the iP-25E and proper projection will not be possible. Should this occur, a proper image will not be obtained even when adjustments are made with the iP-25E.

In some instances, the personal computer screen will be properly projected by the iP-25E when the simultaneous display is cancelled and an operation is performed to output only the external output signal. Please see the instruction manual of the notebook computer you are using for details.

## Table of Supported Input Signals (Personal Computer Video Input Connector)

Signals indicated with a "Yes" are supported. Note that depending on the model of personal computer, please perform the screen adjustment of the "Image adjustment" → "Sync adjustment" menu if flickering or bleeding appear on the projection screen.

→ See Page E-37

Signal Name	Resolution (Horizontal × Vertical)		Horizontal Frequency (kHz)	Vertical Frequency (Hz)	Supported
NTSC RGB	–	–	15.7	60	No
PAL/SECAM RGB	–	–	15.6	50	No
PC-98 Normal*	640	400	24.8	56	Yes
PC-98 Hi	640	400	31.5	70	Yes
VGA-GR1	640	480	31.5	60	Yes
VGA-GR2*	640	400	31.5	70	Yes
VGA-GR3*	640	350	31.5	70	Yes
VGA-TX1*	720	400	31.5	70	Yes
VGA-TX2*	720	350	31.5	70	Yes
640 × 480 72Hz	640	480	37.8	72	Yes
640 × 480 75Hz	640	480	37.5	75	Yes
640 × 480 85Hz	640	480	43.2	85	Yes
Mac13" RGB	640	480	35.0	66	Yes
800 × 600 56Hz	800	600	35.1	56	Yes
800 × 600 60Hz	800	600	37.8	60	Yes
800 × 600 72Hz	800	600	48.0	72	Yes
800 × 600 75Hz	800	600	46.8	75	Yes
Mac16" RGB	832	624	49.7	74	Yes
1024 × 768 43Hz	1024	768	35.5	43	No
1024 × 768 60Hz	1024	768	48.3	60	Yes
1024 × 768 70Hz	1024	768	56.4	70	Yes
1024 × 768 75Hz	1024	768	60.0	75	Yes
1024 × 768 85Hz	1024	768	68.7	85	Yes
MAC19"1024 × 768	1024	768	60.2	75	Yes
MAC21"1152 × 864	1152	864	68.7	75	Yes
1280 × 960 60Hz	1280	960	60.0	60	Yes
1280 × 960 85Hz	1280	960	85.9	85	No
1280 × 1024 60Hz	1280	1024	64.0	60	Yes
1280 × 1024 75Hz	1280	1024	80.0	75	No
1280 × 1024 85Hz	1280	1024	91.1	85	No
1600 × 1200 60Hz	1600	1200	75.0	60	No
1600 × 1200 65Hz	1600	1200	81.3	65	No
1600 × 1200 70Hz	1600	1200	87.5	70	No
1600 × 1200 75Hz	1600	1200	93.8	75	No
1600 × 1200 85Hz	1600	1200	106.3	85	No

- When the resolution of the input signal is lower than 1024 × 768 dots, the image is enlarged and displayed; if the resolution is higher than 1024 × 768 dots, the image is reduced and displayed.
- The signals above marked with (\*) may not display properly when full keystone correction is applied. When using these signals and applying keystone correction, please check the image while making the setting so that the image is not adversely affected.

# Connections with Video Equipment

The video of a video tape deck or DVD player is projected onto a large screen.

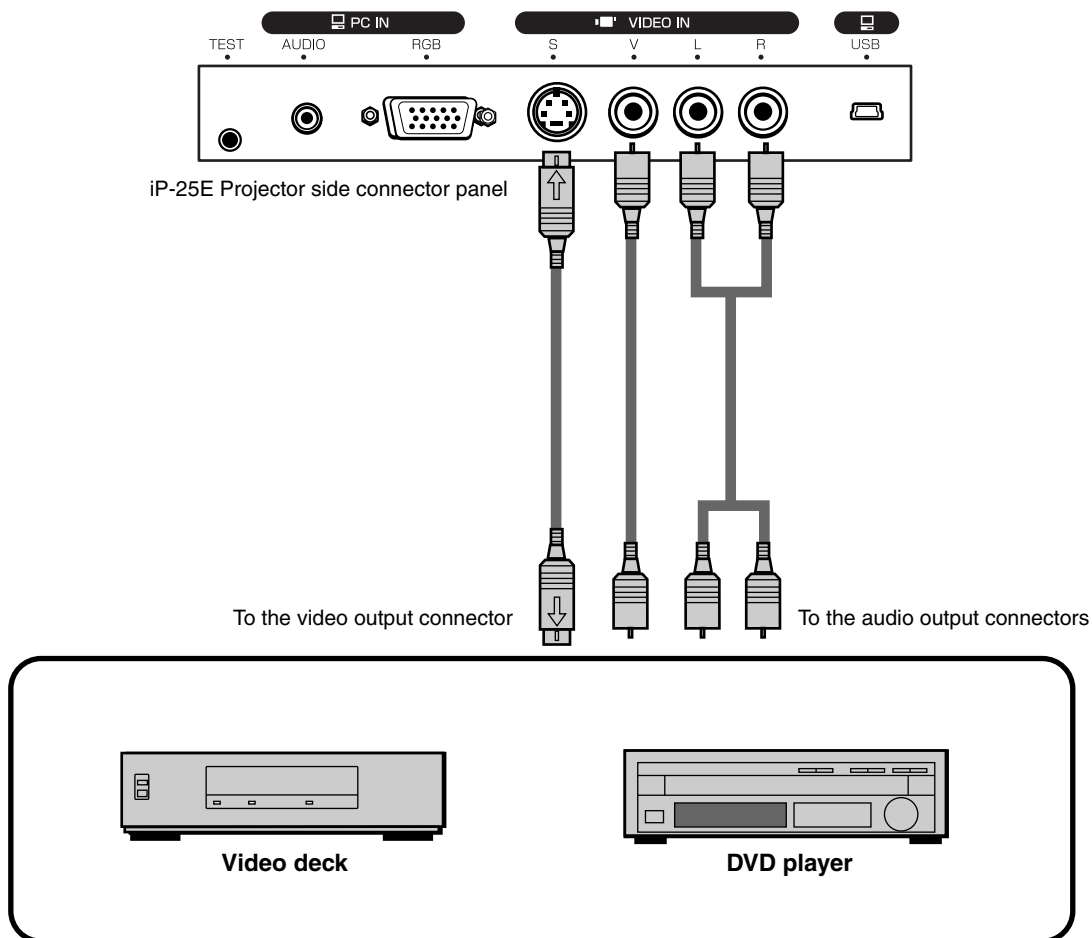

## NOTE:

- When both Video and S-video connections have been made, S-video will be given priority for display.
- When a video signal have a lot of noise, the image may be displayed in monochrome. Should this occur, make a setting with the "Video select" menu to suit the input signal.
- When a condition in which a signal has not been input continues for 15 minutes or longer, the lamp is turned off automatically.

# Connection of the Power Cable and On/Off Switching

## Switch On the Power

### 1 Connect the power cable

The projector will enter the standby mode and the ON/STANDBY LED will light in red.

To wall outlet.

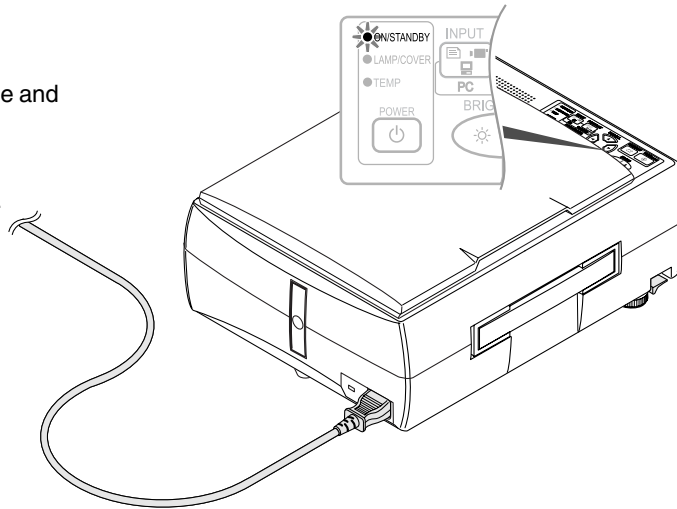

### 2 Press the POWER button (⏻)

Operation with the Projector

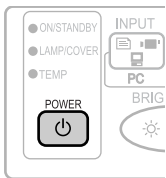

Operation with the Remote Control



The fan will turn, the lamp will light, and the ON/STANDBY LED will light in green. The LAMP/COVER LED will light in green.

- If the LED lights in red after the POWER button is pressed, projector trouble is indicated.

→ See Page E-40

- Check that the lens cap has been removed before pressing the POWER button.

The projector is now able to make a projection.

### 3 Switch on the power of the connected equipment

## Switch Off the Power

### 1 Press and hold the POWER button (⏻) for 1 second or longer

"Press POWER button again to turn off" will appear on the projection screen.

Operation with the Projector

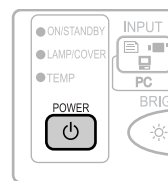

Operation with the Remote Control



### 2 Press the POWER button (⏻) one more time.

The lamp will go off.

- The LAMP/COVER LED flashes green and then goes off after about 60 seconds.

The ON/STANDBY LED lights in red.

- When the lamp is off, pressing the POWER button while the LAMP/COVER LED is flashing green will not switch the lamp on again.

To switch the lamp on again, please press the POWER button again after the ON/STANDBY LED lights in red.

### 3 Disconnecting the Power Cable

The ON/STANDBY LED on the operation panel will go off.

#### ⚠ CAUTION

- Do not disconnect the power cable while the lamp is on or while the ventilation fan is turning.
- Unplug the power plug of the projector from the wall outlet when the projector will not be used for an extended period.
- When the reinserting the power plug into the outlet soon after having unplugged it, please allow a fixed time (of about 10 seconds) before doing so.

# Adjustment of the Projection Image

## Adjusting the Projection Image

Adjust the projection image to the screen.

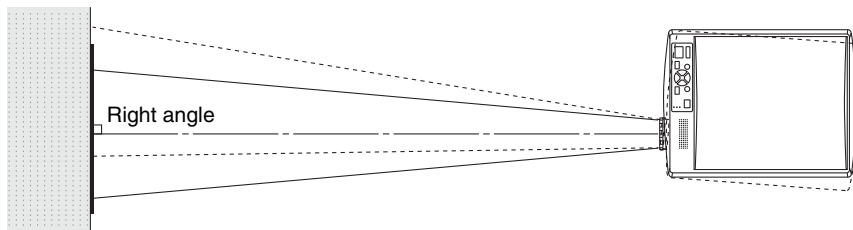

- When the image is shifted to the left or right, move the projector horizontally. (Align the center of the screen with the center of the projector lens.)
- When the image is shifted up or down, use the tilt foot to adjust the projector vertically.
- When the image is slanted, turn the left or right tilt foot to adjust.
- When there is keystone distortion of the image, adjust with "Keystone" of the menu operations. → See Pages E-33 and 38.

## Making Focus/Zoom Adjustments

Turn the focus ring/zoom lever of the projection lens and adjust the projection image.

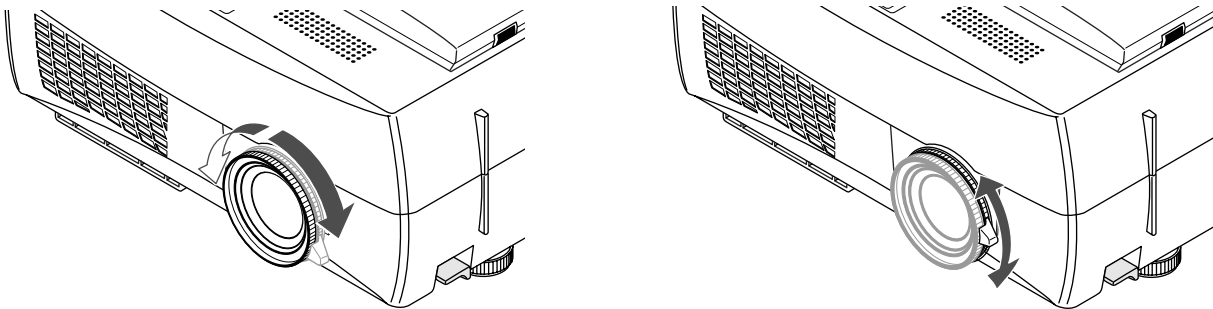

## Adjusting the Tilt (Slant)

Adjustment of the tilt foot allows the position and slant of the projection image to be adjusted.

Press the left-right tilt adjustment lever and raise the front of the projector. Release the lever when the desired height has been reached. Rotating the lowest portion of the tilt foot permits fine adjustments to be made. The tilt foot are lengthened by rotated to the left and shortened by rotated to the right.

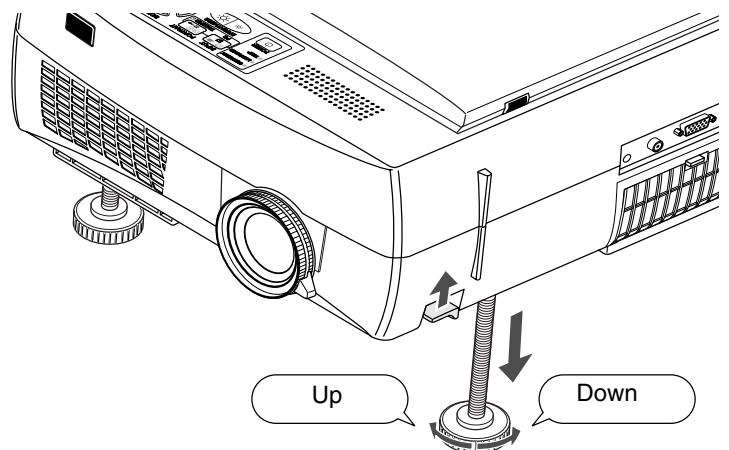

### CAUTION

- Do not lengthen the tilt foot on only one side which would place the projector on an extreme slant. Doing so could result in the projector slipping or falling over and could cause an accident or breakdown.
- When moving the projector, be sure to return the tilt foot to the original position.
- The air intake vents on the side of the projector draw in cooling air with a strong air current. When cloth or paper adheres to and covers the air intake vents, the internal temperature rises and could cause an accident or breakdown.
- Depending upon the material of the placement location, the rubber feet may soil on the placement surface.

# Regular Operation

This section describes the use of direct operation using the projector and remote control buttons.

Please see the items on Page E-32 "Menu Operation Method" and Page E-35 "Menu Description" for information about operation using the menu.

## Select the Input

When the power of the projector is switched on, the input selection (OHP / PC / VIDEO) icon is displayed.

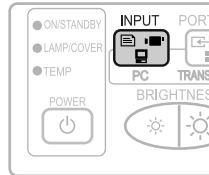
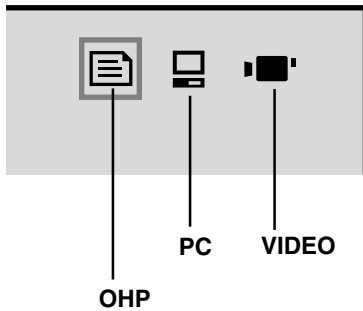

### Operation with the Projector

Select the input using the INPUT SELECT buttons. Each press switches the input one step in the sequence of OHP → PC → VIDEO.

### Operation with the Remote Control

Select the input using the INPUT SELECT buttons.

#### NOTE:

- The input mode at starting time will be the same as it was the last time the projector was switched off.
- When the icon is displayed, either the left or right key permits input switching.

## Changing the Orientation of the Projection Image

Effective Only with OHP Input

This operation switches the (vertical/horizontal) orientation of the currently projected image.

The display of the switched screen is adjusted to match the width.

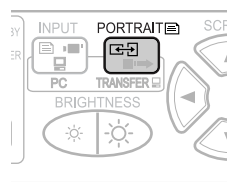
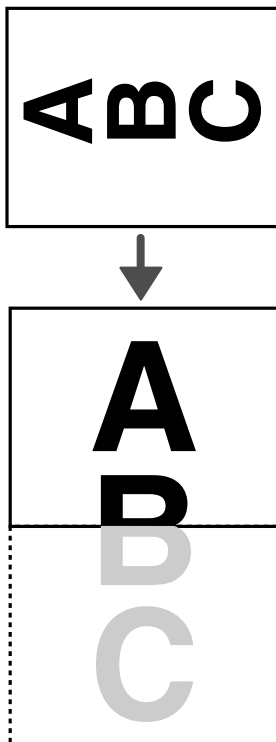

### Operation with the Projector

Press the PORTRAIT button.



### Operation with the Remote Control

Press the PORTRAIT button.

**To view the portion that has been cut off**

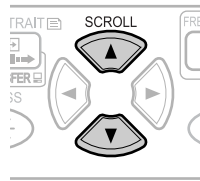
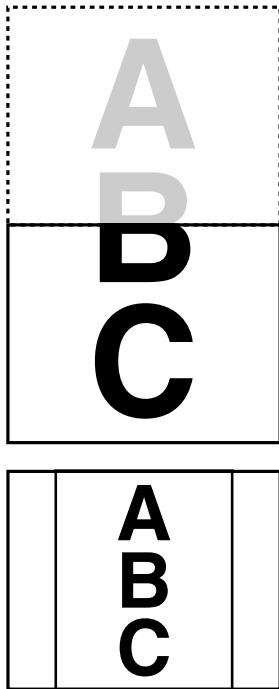

**Operation with the Projector**

Press the SCROLL (▲▼) buttons and scroll the projection image up or down.

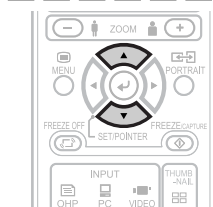

**Operation with the Remote Control**

Press the SCROLL (▲▼) buttons and scroll the projection image up or down.

- Pressing the ZOOM (–) button permits display of a large portion within the reading range of the vertical display. The undisplayed portion can be displayed with the SCROLL (▲▼) buttons.

**NOTE:** When the orientation of the projection image is changed, even if the zoom function is in use, the display of the switched screen will be adjusted to match the width, the same as with regular changes of orientation.

**Enlarging and Reducing the Projection Image**

This operation enlarges or reduces the size of projected image.

During OHP input, adjustment from the same size to 6.25 times (length ratio 2.5 times) is permitted, while during PC or VIDEO input, adjustment from the same size to 16 times (length ratio 4 times) is permitted.

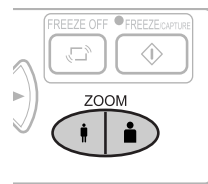
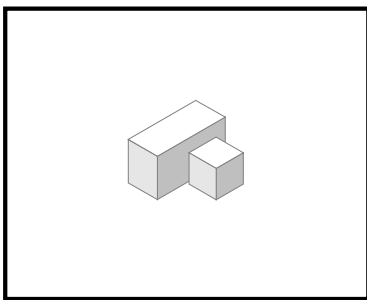

**Operation with the Projector**

Press the ZOOM button.

■ (+) : Enlarge the size of the projected image

■ (-) : Reduce the size of the projected image

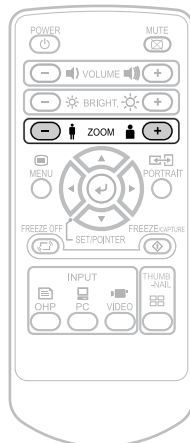

**Operation with the Remote Control**

■ (+) : Enlarge the size of the projected image

■ (-) : Reduce the size of the projected image



## Moving the Screen

Movement is possible in 4 directions (up, down, left, and right).

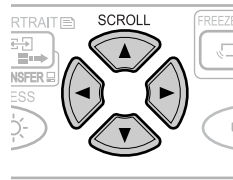
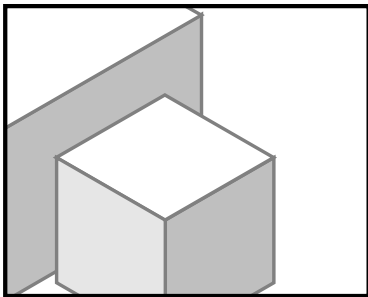
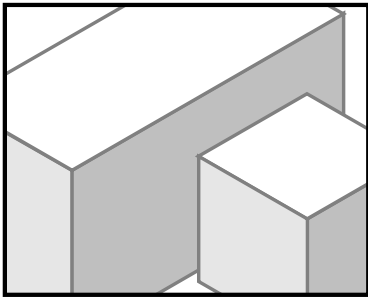

### Operation with the Projector

Press the SCROLL (▲▼◀▶) buttons.

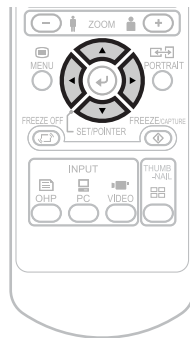

### Operation with the Remote Control

Press the SCROLL (▲▼◀▶) buttons.

## Adjusting the Brightness

To change the brightness, perform a manual adjustment using the method described below.



Brightness adjustment bar

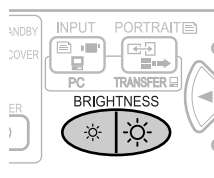

### Operation with the Projector

Adjust using the BRIGHTNESS (☀️ ⚡️) buttons.

☀️ : Projection image becomes brighter

⚡️ : Projection image becomes darker



### Operation with the Remote Control

Adjust using the BRIGHTNESS (+)/(-) buttons.

☀️ (+) : Projection image becomes brighter

⚡️ (-) : Projection image becomes darker

**NOTE:** Once the brightness adjustment bar has been displayed, it will disappear after 10 seconds if there is no brightness adjustment.

**Capturing the Projection Image** Effective Only with OHP Input / **Still Image Display**

**During OHP Input**

Pressing the FREEZE/CAPTURE button captures the OHP image that is currently being projected and saves it as an image file.

Captured images are automatically stored in the internal memory as OHP history images for up to 32 pages.

The projected image will become a frozen (fixed) display.

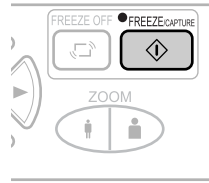

**Operation with the Projector**

Press the FREEZE/CAPTURE button.

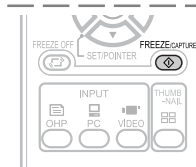

**Operation with the Remote Control**

Press the FREEZE/CAPTURE button.

**USB Connection Is Available**

By transferring the images that are in memory to the personal computer, they can be stored again in the 32-page memory.

The USB icon is displayed at the time of image capture. The icon display will differ depending on the current number of memory pages.

(1 to 10 pages  / 11 to 20 pages  / 21 to 31 pages  / 32 pages )

Please see Page E-28 for information about the method of transfer.



**USB Connection Is Not Available**

Once 32 pages have been stored, each time a new image is captured, an old image will be deleted.

The Freeze icon is displayed at the time of image capture.

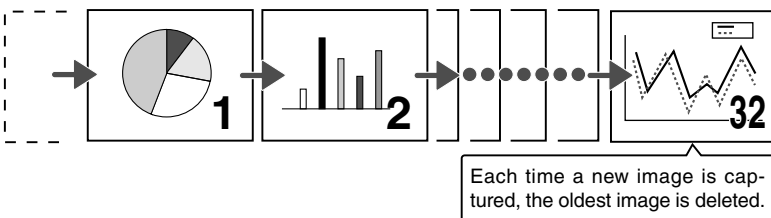

**During PC/VIDEO Input**

Each time the FREEZE/CAPTURE button is pressed, the currently projected image will be frozen (in a fixed display).

**NOTE:**

- The FREEZE LED is lit green during the still image display.
- A press of the FREEZE/CAPTURE button while a moving image is projected will result in a still image display at the existing zoom magnification and position.
- A press of the FREEZE/CAPTURE button at the time of still image of OHP will result in a return of the zoom magnification and position to the original condition.
- A press of the projector INPUT SELECT buttons or one of the remote control OHP / PC / VIDEO buttons during a still image display will cancel the still image of the PC or video deck. OHP will retain the still image.

## Cancelling the Still Image Display

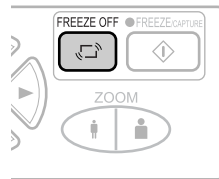

**Operation with the Projector**  
Press the FREEZE OFF button.

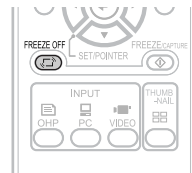

**Operation with the Remote Control**  
Press the FREEZE OFF button.

**NOTE:** The FREEZE LED will go off when the still image display is cancelled.

## Viewing OHP History Images

### Viewing captured images

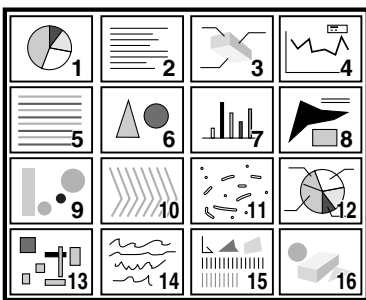

**Operation with the Projector**  
A list display of captured images is not available from the operation panel of the projector.

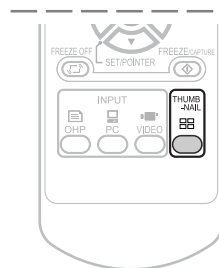

**Operation with the Remote Control**  
Press the THUMB-NAIL button.

### Full-screen Display of Thumbnail Images

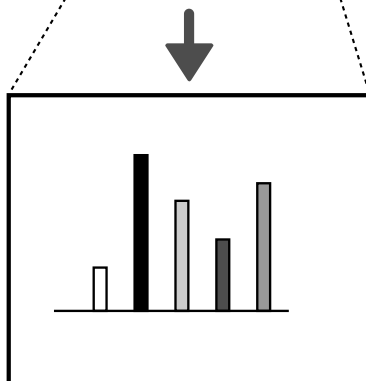
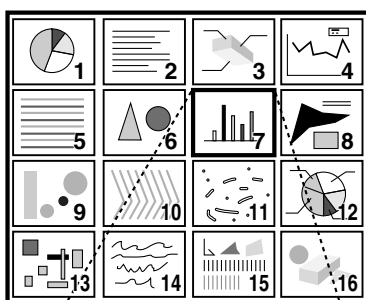

**Operation with the Projector**  
A full-screen display of captured images is not available from the operation panel of the projector.

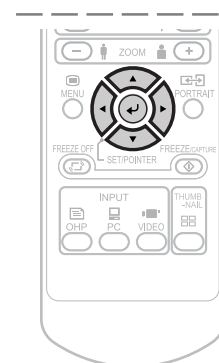

**Operation with the Remote Control**  
Select the images that you would like to display full screen using the SCROLL (▲▼◀▶) buttons and press the POINTER/SET button.

**NOTE:** The FREEZE LED is lit orange during the thumbnail display.

## Transferring Captured Images

When connection is made with a USB cable, history images can be transferred to the personal computer. Please switch the input to "PC" and press the data TRANSFER button.

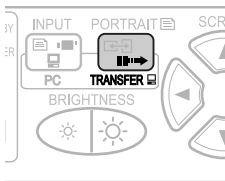

**Operation with the Projector**  
Press the TRANSFER button.

**NOTE:** Please see the attached "iP Viewer Program Quick Reference" or the "iP Viewer Software Program Operating Instructions" for information about the iP Viewer operation method.

## Adjusting the Volume

Effective only During PC and VIDEO Input



Volume adjustment bar

**Operation with the Projector**  
Volume adjustment cannot be made at the operation panel of the projector.



**Operation with the Remote Control**  
Adjust using the VOLUME (+/-) buttons.

**NOTE:** Once the volume adjustment bar has been displayed, it will disappear when 10 seconds have passed without a volume adjustment operation being made.

## Displaying the Pointer

This operation displays the pointer in the currently projected image.

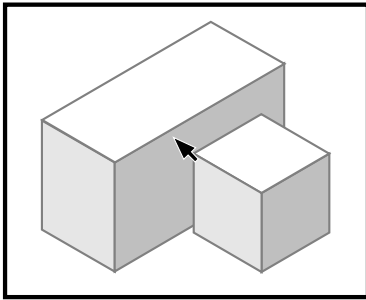

### Operation with the Projector

The ability to turn on and turn off the pointer is not available from the operation panel of the projector.

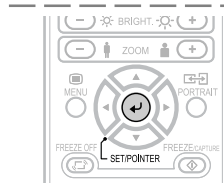

### Operation with the Remote Control

Press the POINTER/SET button.

One more press of the POINTER/SET button while the pointer is displayed will turn off the pointer display.

## Moving the Pointer

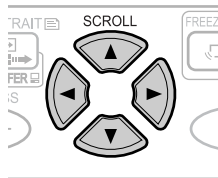
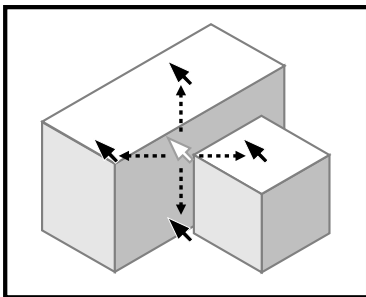

### Operation with the Projector

Press the SCROLL (▲▼◀▶) buttons.

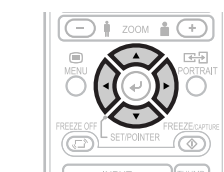

### Operation with the Remote Control

Press the SCROLL (▲▼◀▶) buttons.

See Page E-35 for information about the form, color, and size of the pointer.

### NOTE:

- When the brightness is adjusted while the pointer is displayed, the pointer will disappear temporarily; however, it will reappear soon.

## Deleting the Projection Image and Audio

This operation deletes the currently projected image and audio without switching off the lamp.

### Operation with the Projector

The ability to delete the projection image is not available from the operation panel of the projector.



### Operation with the Remote Control

Press the MUTE button.

**NOTE:** When a fixed period of time elapses (about 30 minutes) with the video/audio muted, a message will be displayed to check whether to shut down the projector. Selection of "Yes" will set the projector to the standby mode, while a selection of "No" will again delete the video/audio.

When there has been an absence of an operation for 15 seconds during the display of the above confirmation message, the projector automatically enters the standby mode.

# Method of OHP Operation

## Attaching the Document Cover

The mounting orientation of the document cover can be changed to the opposite direction in accordance with the circumstances.

**NOTE:** When removing the document cover, lift the cover by both hands and remove it.

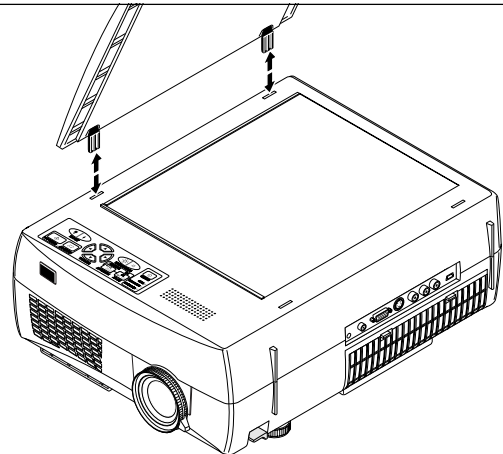

## Preparation of the Projection Document

The document (printed material) that is to be projected is placed on the projector as illustrated in the diagram below and the document cover is closed.

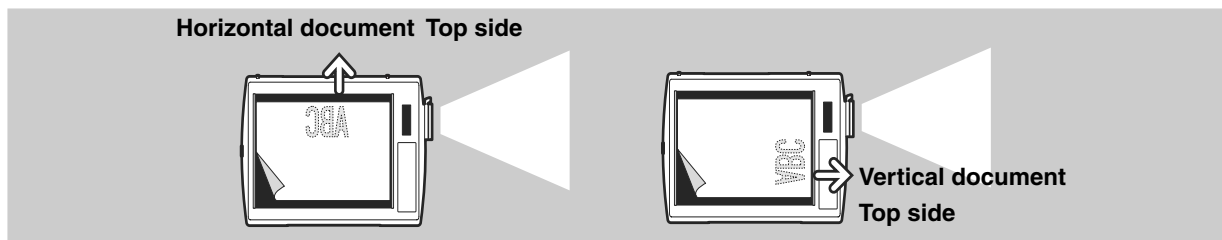

**NOTE:**

- The document can be projected even when the document cover has not been closed; however, in this instance, unnecessary items may be projected which will make the image difficult to view.
- When paper having luster such as magazine covers are placed on the projector, the internal fluorescent lamp light will be picked up and the edges of the projected document may be messy.

## Reading Size of Projection Documents

The maximum reading size of documents and printed material is 216 mm high by 288 mm wide.

Consequently, when A4 paper (210 mm high and 297.5 mm wide) is placed on the projector, reading will be as illustrated in the diagram below (which depicts the area that can be projected as the portion with diagonal lines).

The portion that falls outside of the reading range will not be projected; therefore, shift the paper as required.

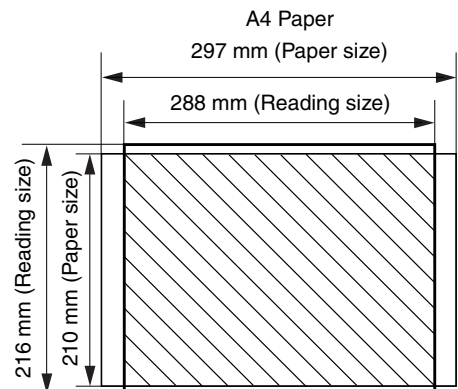

**Other functions that are used in the OHP operation can be seen on the following pages:**

- Switching the input to OHP → See Page E-23
- Changing the projection image to a still image display → See Page E-26
- Capturing a projection image → See Page E-26
- Viewing captured images → See Page E-27

# Menu Configuration

The adjustment/setting items and content will differ depending on the input selection and the permitted information will be displayed on the menu for that input mode.

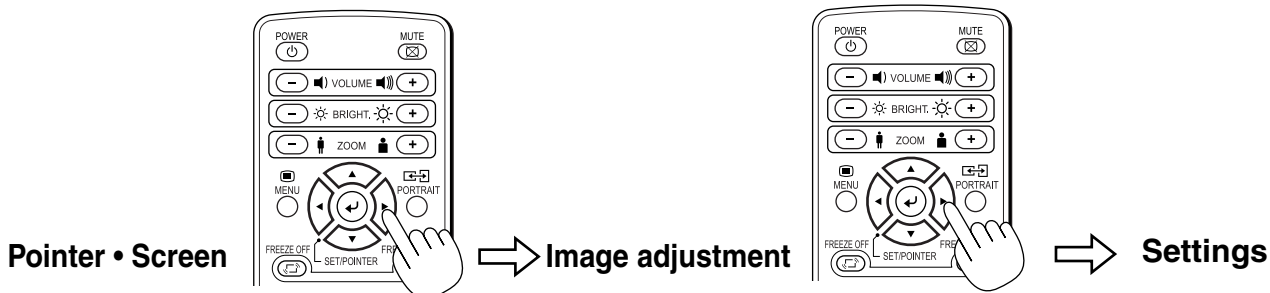

## OHP / PC / VIDEO Common

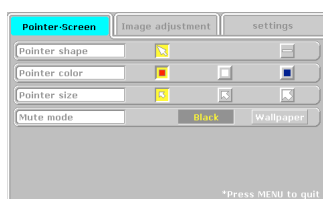

## During OHP History List Display

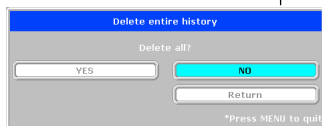
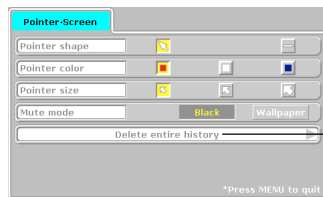

## During OHP History Single-page Display

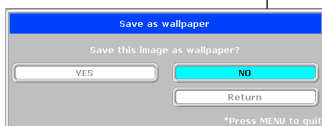
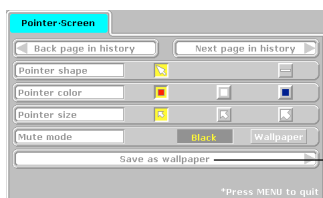

## During OHP Input

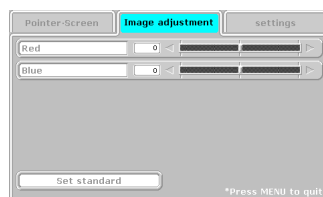

## During PC Input

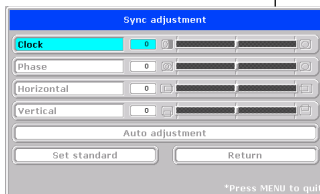
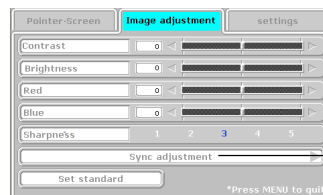

## During VIDEO Input

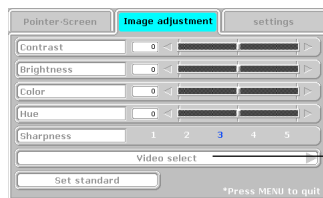

## OHP / PC / VIDEO Common

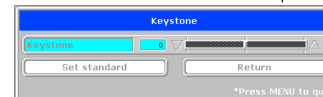
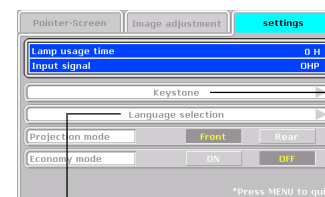

# Menu Operation Method

## Names and Functions of the Buttons Used in Menu Operation

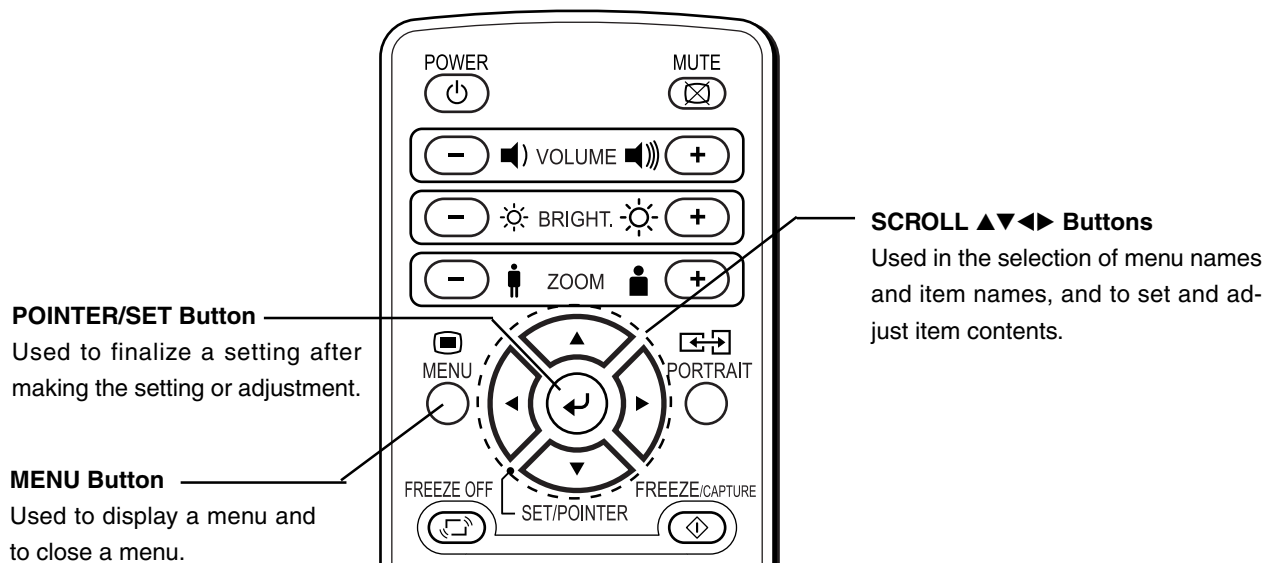

## Names and Functions of the Menu Parts

**Menu tab**  
Switches to the various menus when selected.

**Cursor (Light blue)**  
Selects the item that you would like to set or adjust.

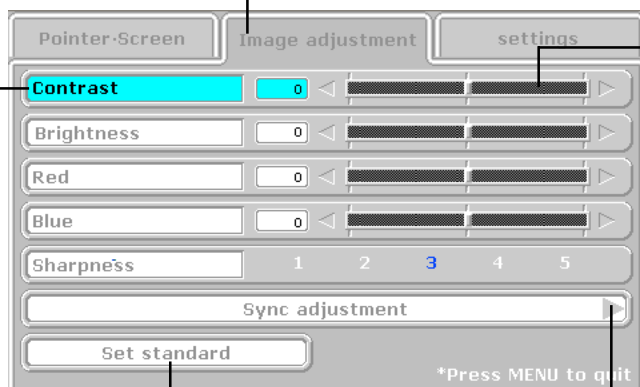

**Adjustment bar**  
Indicates the adjustment condition according to the increase or decrease of the bar point.

Returns the set or adjusted item to the standard value (shipping default condition of our factory).

### Sub menu icon

When an item containing this icon is selected, there is a change to the sub menu.

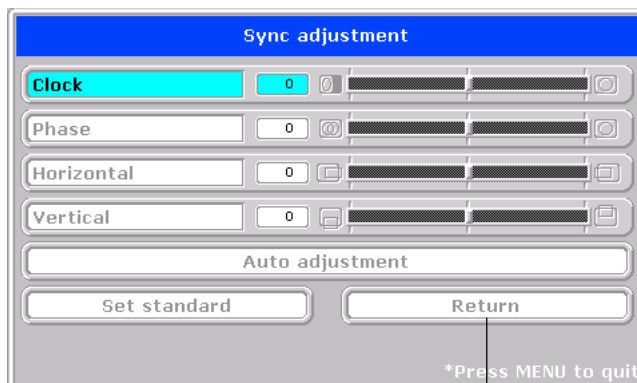

Returns to the menu that is one layer higher.



## Method of Menu Operation

This section describes the actual operation method. Adjustment of [Keystone] using the remote control is provided as an example.

### 1 Press the MENU button and display the menu

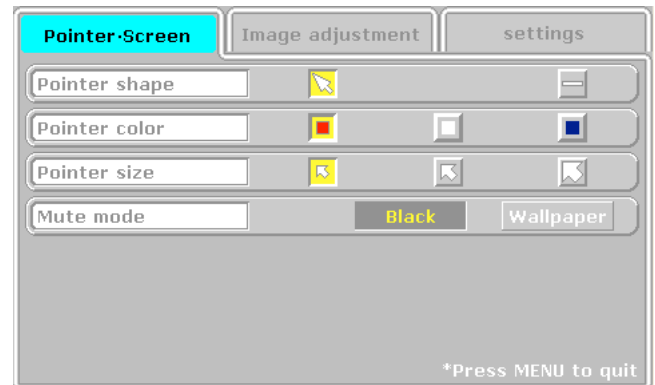
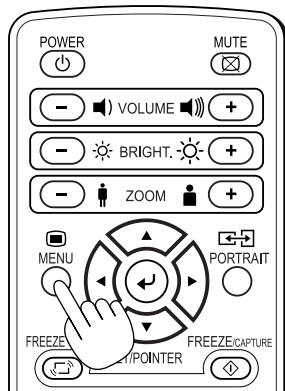

### 2 Select [Settings] with the SCROLL ◀▶ buttons

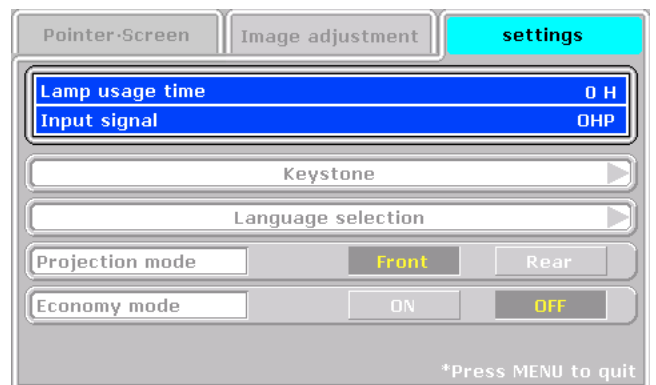
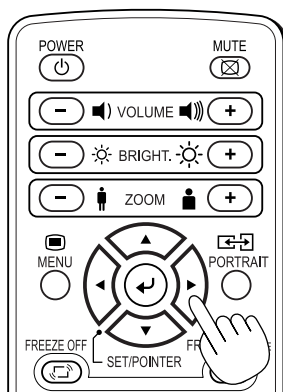

Each press of the SCROLL ▶ button switches the menu one step in the sequence of [Pointer • Screen] → [Image adjustment] → [Settings], and each press of the SCROLL ◀ button causes a return in the opposite direction.

### 3 Select [Keystone] with the SCROLL ▼ button

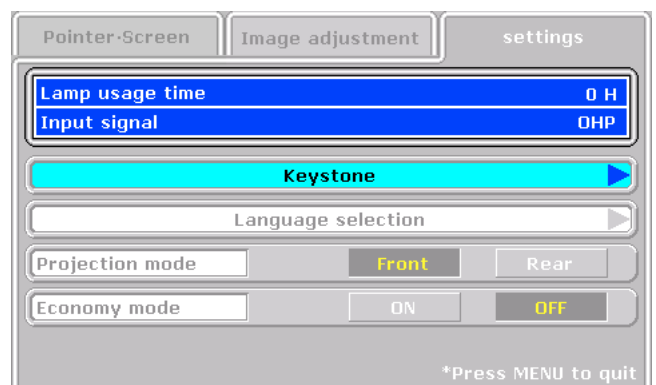
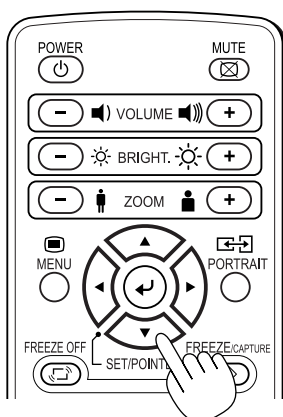

Move the cursor and select [Keystone].

## 4 Press the POINTER/SET Button

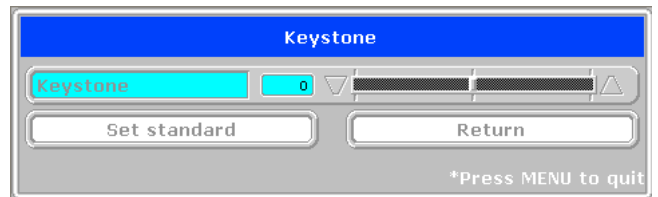
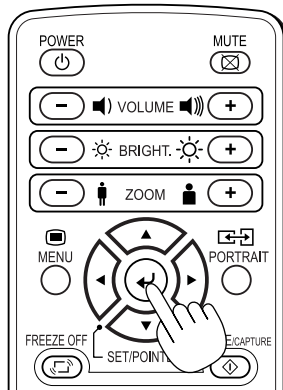

Switches the menu to the sub menu (i.e., the Keystone adjustment menu).

## 5 Make the adjustment with the SCROLL ◀▶ buttons while checking the projection image

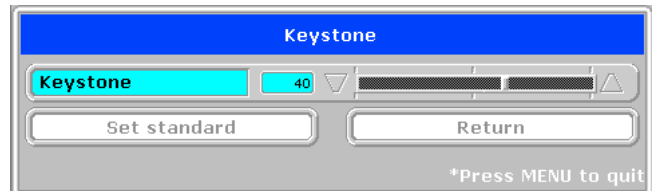
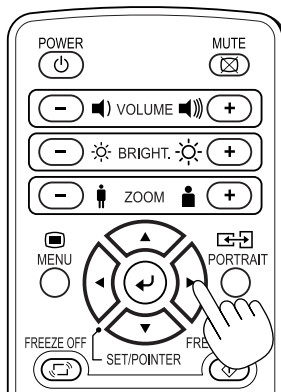

- SCROLL ◀ button: Each press causes the numerical value to decrease.  
(The lower portion of the projection image becomes narrower.)
- SCROLL ▶ button: Each press causes the numerical value to increase.  
(The upper portion of the projection image becomes narrower.)

## 6 Press the MENU button and close the menu

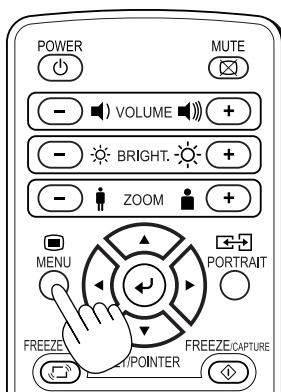

This completes the [Keystone] adjustment.

# Menu Description

## Pntr setting

This selects the shape, color, and size of the pointer.

- Pointer shape ..... Selects the shape of the pointer from 2 types.
- Pointer color ..... Selects the color of the pointer from amongst 3 types (i.e., red, white, and blue).
- Pointer size ..... The size of the pointer can be changed in 3 levels.
- Mute mode ..... Sets the image that will be displayed at the time of screen deletion.  
Black: Displays an entirely black screen  
Wallpaper: Displays an image that was saved as wallpaper.

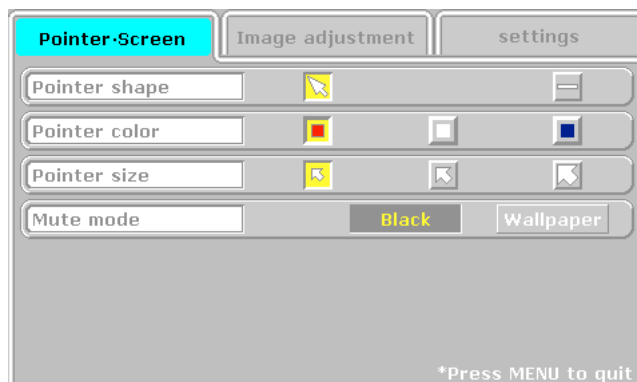

The following items will be displayed only during the projection of the OHP history list screen.

- Delete entire history ..... A confirmation screen will be displayed. Select "YES" and press the POINTER/SET button to delete all of the OHP history images that are saved in the internal memory.

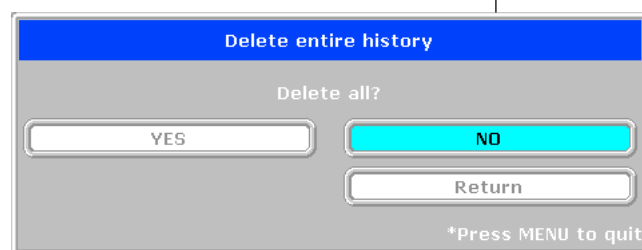
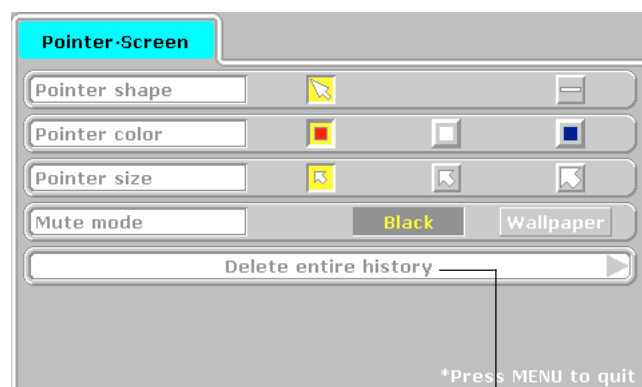

The following items will be displayed only during the projection of the page that was selected from the OHP history list.

- Back page in history ..... Switches to the history screen that was stored before the currently projected history screen.
- Next page in history ..... Switches to the history screen that was stored immediately after the currently projected history screen.
- Save as wallpaper ..... A confirmation screen will be displayed. Select "YES" and press the Set/Pointer button to save as wallpaper the currently displayed history image.

**NOTE:**

- Horizontal images that are not being zoomed can be saved as wallpaper.
- It may not be possible to save images having many colors or images having a lot of fine patterns.
- When new wallpaper is saved, the previous wallpaper will be deleted.

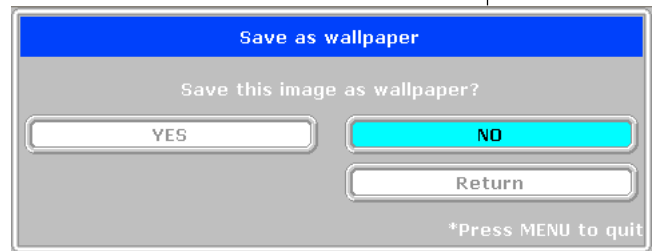
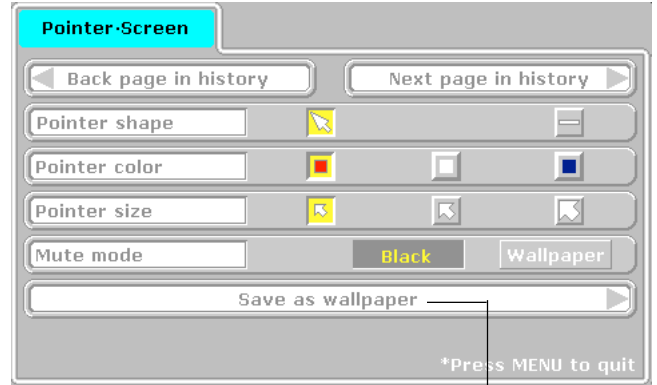

## Image adjustment

This performs the settings and adjustments related to the projected image.

**When OHP input has been selected.**

- Red  
(Red color adjustment) ..... Adjusts the deepness of the red color in the range of -50 to 50.
- Blue  
(Blue color adjustment) ..... Adjusts the deepness of the blue color in the range of -50 to 50.

**When PC input has been selected**

- Contrast ..... Adjusts the contrast of the projected image in the range of -50 to 50.
- Brightness ..... Adjusts the brightness of the projected image in the range of -50 to 50.
- Red  
(Red color adjustment) ..... Adjusts the deepness of the red color in the range of -50 to 50.
- Blue  
(Blue color adjustment) ..... Adjusts the deepness of the blue color in the range of -50 to 50.
- Sharpness ..... Selects the sharpness of the projected image from amongst 5 levels. As the numerical value increases, the sharpness of the image is enhanced.

**During OHP input**

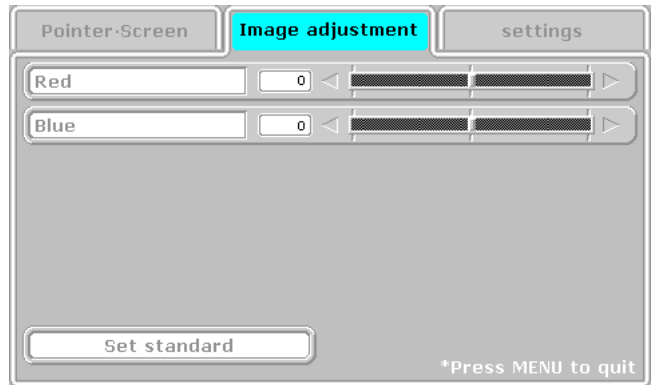

**During PC input**

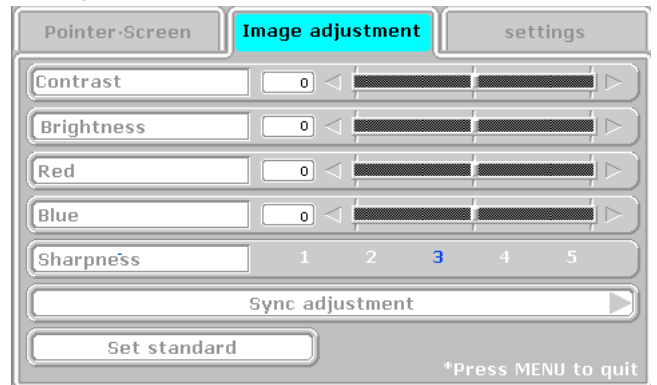

### Sub menu: Sync adjustment

- Clock ..... Adjusts the horizontal size of the projected image in the range of -50 to 50.
- Phase ..... Adjusts the noise/flickering of the projected image in the range of -50 to 50.
- Horizontal ..... Adjusts the horizontal position of the projected image in the range of -50 to 50.
- Vertical ..... Adjusts the vertical position of the projected image in the range of -50 to 50.
- Auto adjustment ..... Performs sync adjustment automatically.

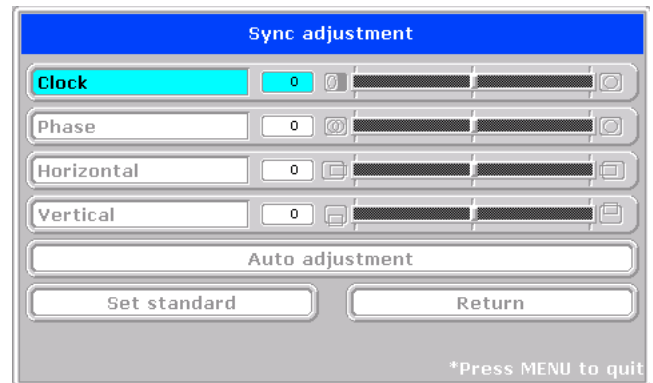

**NOTE:** Depending on the PC input signal, there might not be a change as far as from -50 to 50.

### When VIDEO input has been selected

- Contrast ..... Adjusts the contrast of the projected image in the range of -50 to 50.
- Brightness ..... Adjusts the brightness of the projected image in the range of -50 to 50.
- Color ..... Adjusts the deepness of the color in the range of -50 to 50.
- Hue ..... Adjusts the hue in the range of -50 to 50. As the numerical value becomes lower, the color becomes greenish and as the numerical value increases, the color becomes red-dish.
- Sharpness ..... Selects the sharpness of the projected image from amongst 5 levels. As the numerical value increases, the sharpness of the image is enhanced.

### During VIDEO input

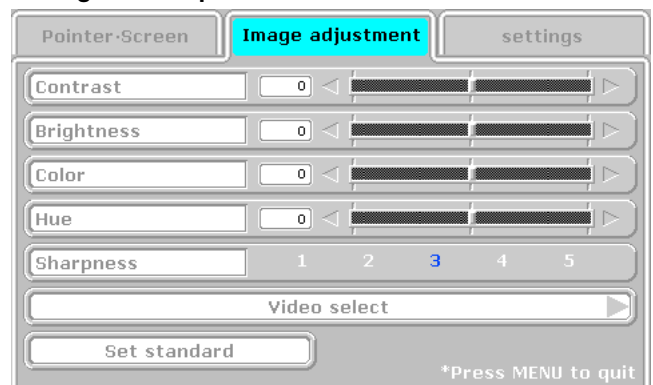

### Sub menu: Video Select

This selects the input signal system.

Auto (detects the signal system automatically) / NTSC 3.58 / NTSC 4.43 / SECAM / PAL B, G, H, I / PAL M / PAL N

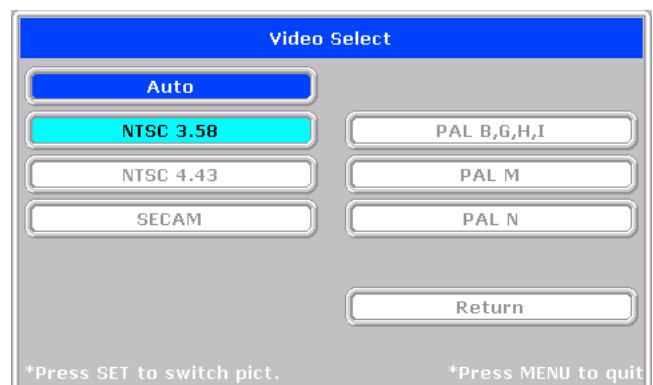

# Settings

This performs settings related to the projector unit or while the projector is in use.

- Lamp usage time ..... Displays the usage time of the lamp. "Replacement of the Lamp Unit" → See Page E-42
- Input signal..... The name of the currently selected input is displayed.

## Setting Items

- Keystone ..... Performs keystone correction of the projection image.

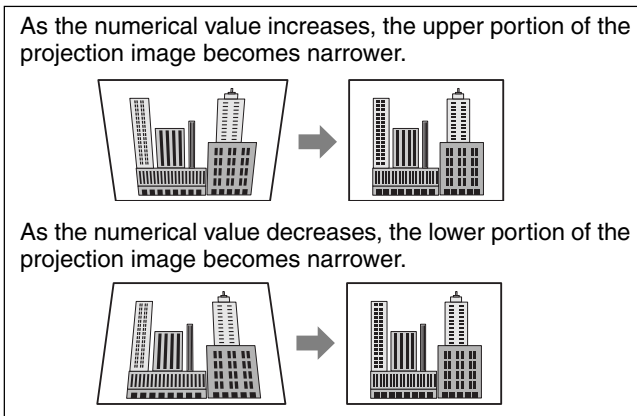

- Language selection..... Selects from among the following languages the language for use in the menus and message indications: Japanese, English, German, French, Spanish, Italian, Chinese, and Korean.

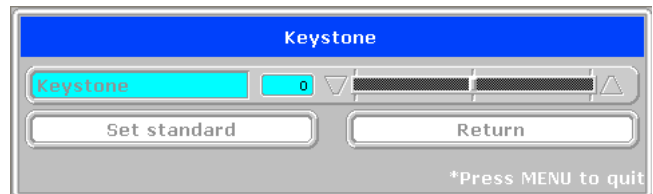
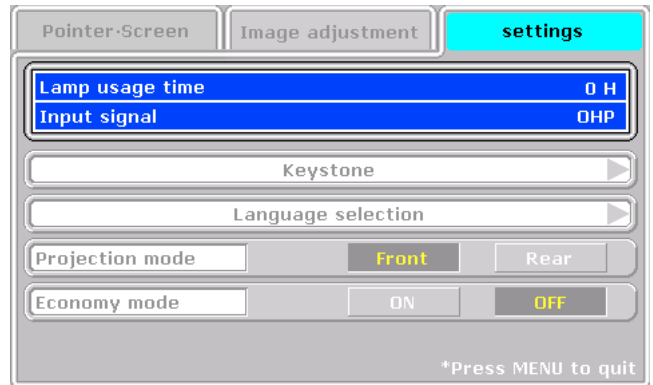

Continued on the next page

**NOTE:**

- When keystone correction has been applied, the resolution at the screen edges will degrade and small characters and the like will become difficult to see. When you do not wish to have the resolution degradation, set the projector on a level platform and set the numerical value of the Keystone menu to "0" (no correction).
- Compared to when keystone correction is not applied, the application of keystone correction results in a display image (of characters, etc.) that appears somewhat blurred and this is related to the image processing that is performed.
- The maximum application of keystone correction when a resolution less than VGA resolution (of 640 × 480 dots) is displayed might result in the disappearance of a portion of the image. Please see Page E-19 for details.
- The keystone correction adjustment range will differ depending on the video signal system.

- Projection mode ..... Selects the projection system of the projector from between Front (front projection) and Rear (rear projection).
- Economy mode ..... **ON (Economy mode):**  
The brightness of the lamp will be approximately 80%. The lamp service life will be extended.  
**OFF (High brightness mode):**  
The brightness of the lamp will be 100%. There will be a bright screen.

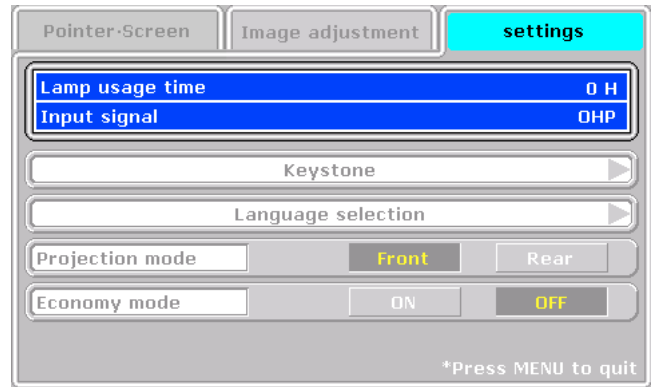

# Maintenance

## Fault Protection

The projector is equipped with a built-in protection circuit to prevent fire and breakdown due to faults.

### When the LAMP/COVER LED lights in red

○ **Measures to be taken**

1. Disconnect the power plug from the outlet.
2. Properly install the air filter. See "Air Filter Cleaning" on Page E-45.
3. Properly install the lamp unit cover. See "Replacement of the Lamp Unit" on Page E-42.

### When the TEMP LED flashes or lights steadily

○ **Measures to be taken**

1. Disconnect the power plug from the outlet.
2. Check the following matters and perform the countermeasure properly.

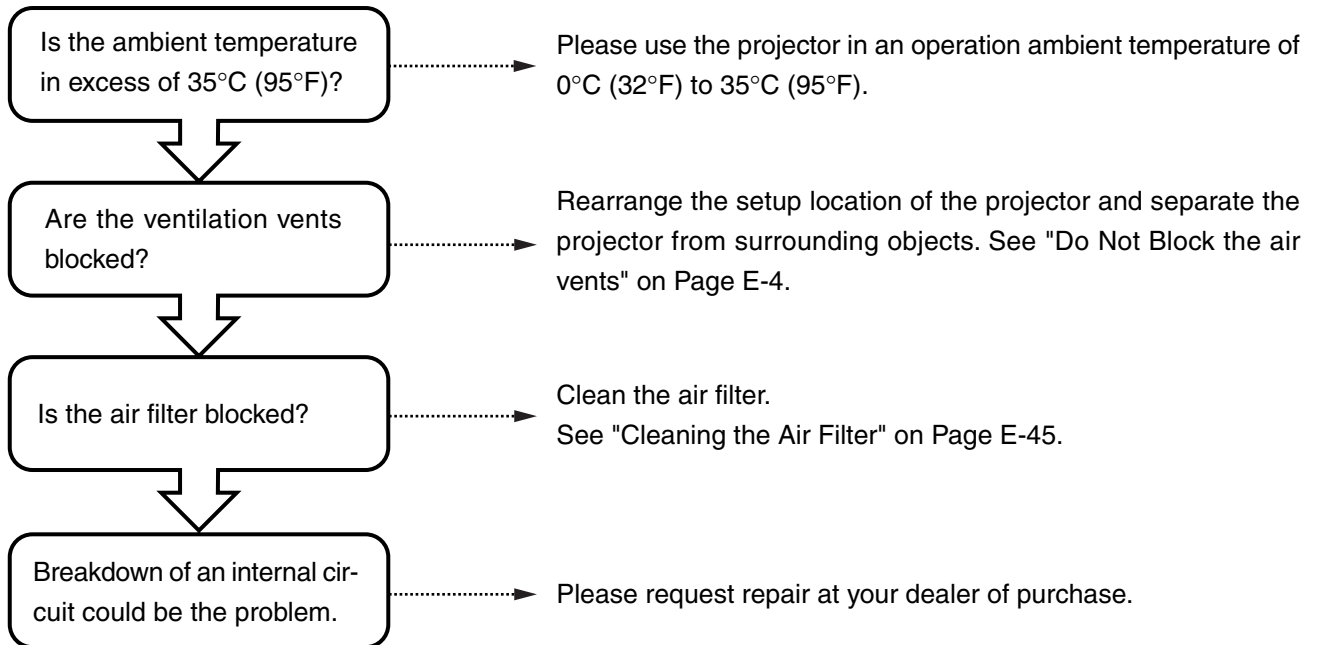

- \* The projector is running properly when the TEMP LED turn off.
- \* When the LAMP/COVER LED is lit red at the same time, please replace the lamp. See Page E-42 for information about the replacement method.
- \* The flashing of the TEMP LED is a warning of a high temperature.  
When the usage circumstances have not changed after 10 seconds have elapsed since the start of the flashing, the TEMP LED changes to be lit steady and the lamp goes off.



**When the power has failed (When all the LED go off with the power ON)****● Measures to be taken**

1. Disconnect the power plug from the outlet.
2. Check the following matters and perform the countermeasure properly.

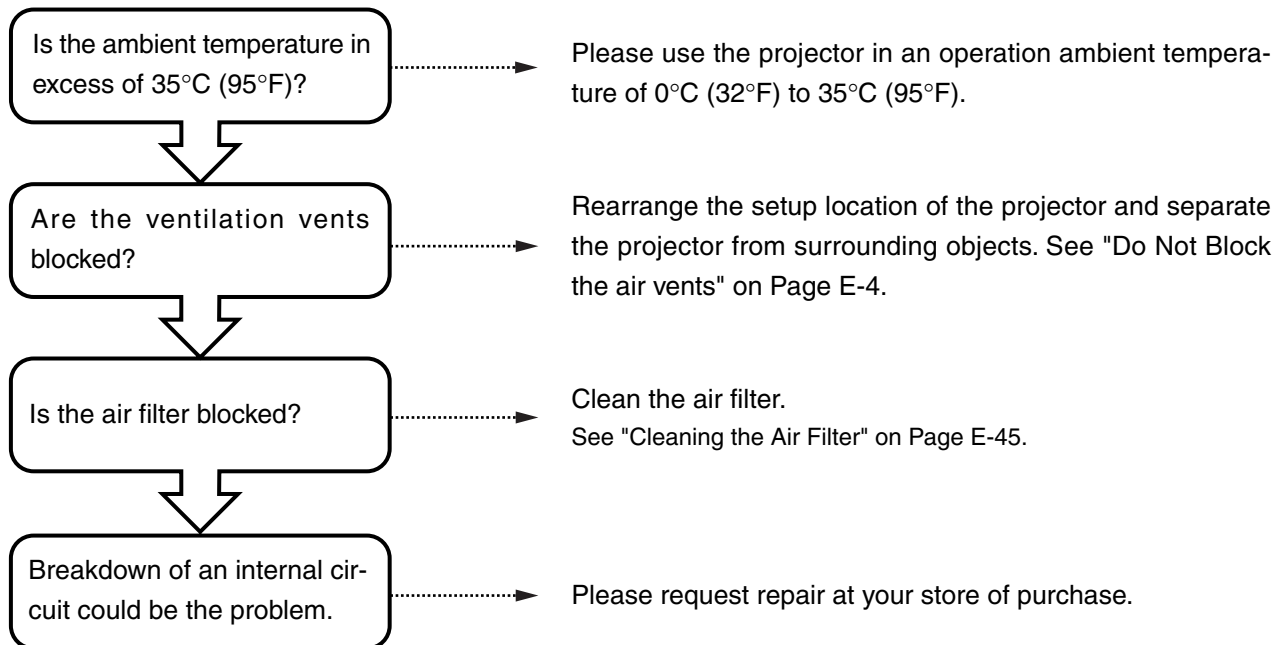

# Replacement of the Lamp Unit

**Guidelines for the replacement of the projection lamp used in this projector are described below. (The time may be shorter depending on usage conditions.)**

**When the usage time exceeds the time described below, the likelihood of rupture increases, the projector will be forced to turn off the projection lamp.**

### Guideline for lamp replacement

- Usage time when used only in the high brightness mode\* ..... 1900 hours
  - Usage time when used only in the economy mode ..... 2900 hours
- Note that the "Lamp usage time" displayed on the menu screen is the value of the usage time of both the brightness mode and the economy mode which has been converted to high brightness mode usage time.
- It is for this reason that when the projector is always used in economy mode, 2900 hours is the lamp replacement guideline for the actual usage time; however, on the menu screen the lamp usage time is 1900 hours which is the guideline for the lamp replacement time.
- (\* See Page E-38.

When the lamp usage time has exceeded 1900 hours, please replace the lamp unit (available separately). Also, when the image becomes dark or the hue worsens, we recommend to replace the lamp; please replace with a new lamp unit.

- **When messages such as the following appear when the lamp lights.**  
(This will be displayed when the lamp usage time exceeds 1900 hours.)

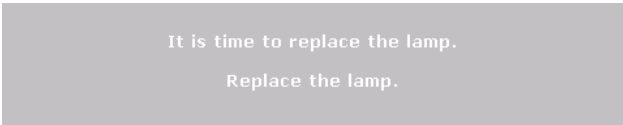

- **When "Lamp usage time" on the menu display screen becomes 1900 hours.**  
The LAMP/COVER LED flashes red.  
The lamp usage time is displayed in the "Settings" menu and can be checked. (See Page E-38.)
- **When the LAMP/COVER LED lights in red without the lamp lighting.**  
(When the lamp usage time has exceeded 2000 hours.)

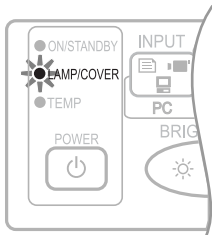

<b>WARNING</b>	<ul style="list-style-type: none"> <li>Do not replace the lamp unit immediately after using the projector. The lamp is high temperature and you could get burned. Disconnect the power plug from the outlet and wait one hour or longer before replacing the lamp.</li> <li>Do not touch the glass portion of the lamp unit with your hands. Doing so could lower the brightness and shorten the life of the lamp.</li> <li>There is a large number of glass parts such as the lamp and mirrors that are used inside the projector. If a glass part breaks, please exercise due caution in handling so that you are not injured by fragments. Please request repair from the store of purchase or an AVIO customer support center.</li> </ul>
----------------	---

<b>CAUTION</b>	<ul style="list-style-type: none"> <li>Please specify the dedicated lamp unit of the MP/iP Series (Model: MPLK-C1).</li> </ul>
----------------	--

## Lamp Unit Replacement Procedure

To prevent burns, wait one hour or longer after the lamp has been switched off before performing the following procedure.

### 1 Remove the lamp unit cover

Using a minus screwdriver, loosen the screws of the lamp unit cover, pull in the direction of the arrow, and remove the cover.

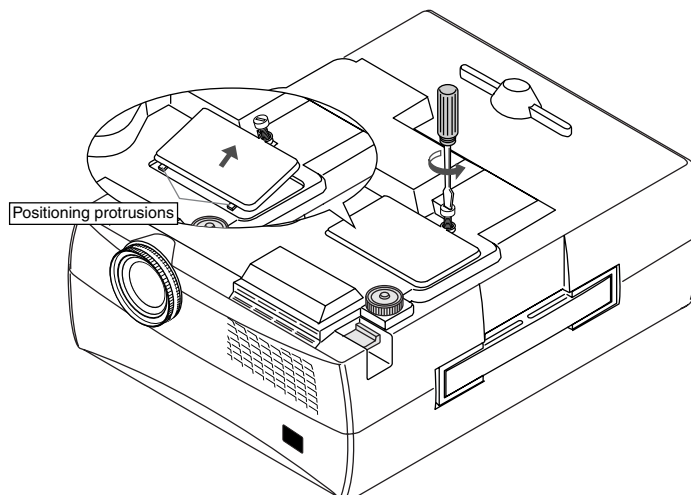

### 2 Loosen the mounting screws of the lamp unit

Using a minus screwdriver, loosen the 2 screws of the lamp unit.

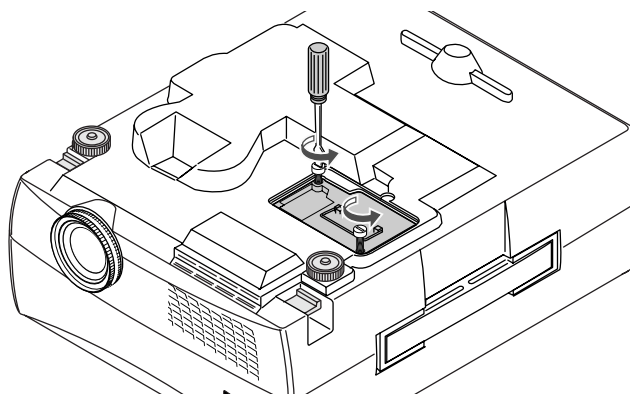

### 3 Pull out the lamp unit

Hold the handle of the lamp unit and pull it up and out.

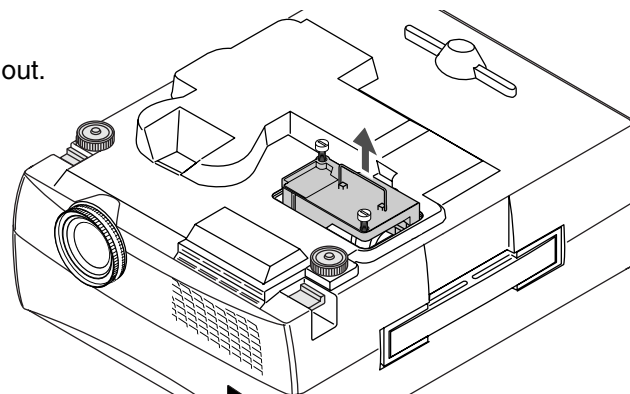

### 4 Install a new lamp unit



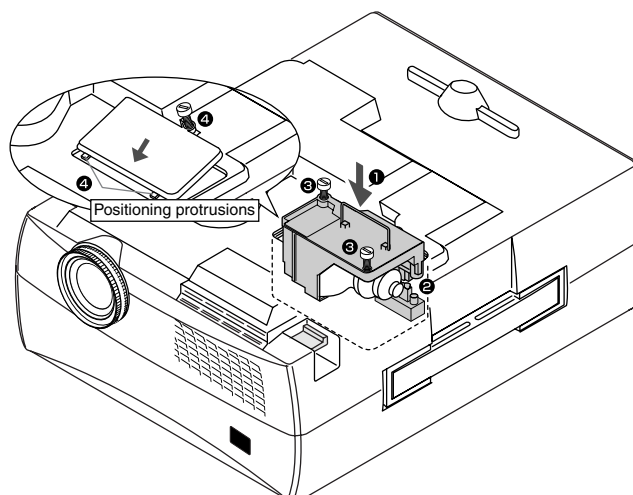

- 1 Take the lamp unit and press it into the projector.
- 2 Check that the 2 positioning protrusions are firmly inserted into the 2 holes.
- 3 Tighten the 2 mounting screws of the lamp unit.
- 4 Align the 2 tabs located on the lamp unit cover with the projector and attach from the side of the tabs. Tighten the mounting screws of the lamp unit cover.



## 5 Reset the lamp usage time

Please perform the operation indicated below in the **standby mode** (\*).

### Operation with the Projector

Press these  →  →  buttons in order while pressing the  button."/>

### Operation with the Remote Control

Resetting of the lamp usage time cannot be performed with the remote control.

The LAMP/COVER LED will flash green following this and projection will start.

\* The power plug is plugged into a power outlet and only the ON/STANDBY LED is lit red.



### CAUTION

- Do not reset the lamp usage time without replacing the lamp. The likelihood of the lamp rupturing becomes higher when the lamp has been used in excess of 2000 hours.

## 6 Check that the indication of the lamp usage time has become "0 H" as illustrated in the diagram to the right.

If the usage time has not been reset, please reset it by following Step 5 again.

Check the lamp usage time by pressing the menu button of the remote control to display the menu, then use the scroll ◀▶ button to display the setup setting.

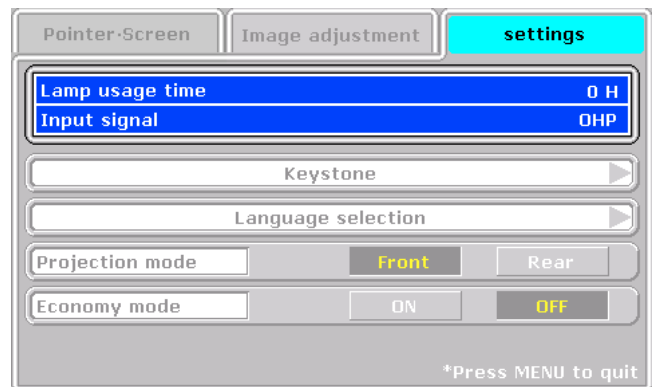

### CAUTION

If the lamp is used without resetting the usage time, the correct lamp usage time will not be known; therefore, be sure to reset the usage time after lamp replacement. When the indication exceeds 2000 hours, the projector will be forced to turn off the projection lamp.

### NOTE:

- In the interest of safety, the lamp will not light when the lamp unit cover is off.
- The lamp units that are available separately are sold together with an air filter as a set in a lamp kit; therefore, please also replace the air filter at the same time as lamp unit replacement. (See Page E-45.)
- Lamp units can be disposed of using the same disposal method as household fluorescent lamps in accordance with the regulations of your region.

## Cleaning the Air Filter

The air filter is an important part that prevents the intrusion of dust onto the optical parts and other parts inside the projector. When the air filter becomes blocked, the internal temperature will rise and the rotation of the fan will also increase leading to a reduction of the service life or causing breakdown. In view of this, the air filter should be cleaned regularly (about once a month, when the projector is used 4 hours per day).

Note that the air filter should be replaced with a new one when it becomes difficult to clean out the dust.

### Air Filter Cleaning Procedure

#### 1 Remove the air filter cover

Press the 2 tabs of the air filter cover downward while swinging the cover outward to remove the air filter cover.

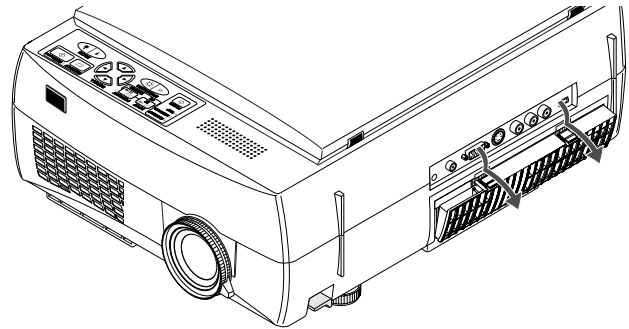

#### 2 Vacuum away the dust

Remove the air filter from the cover and use a vacuum to suck away the dust from the outside surface of the air filter.

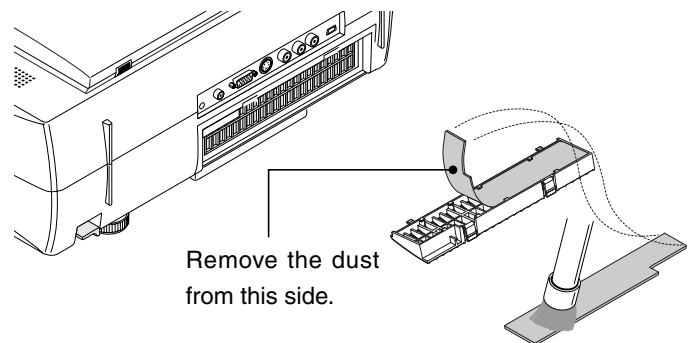

#### 3 Install

Installation is performed by following the steps for removal in reverse order. Press in the air filter cover until a click sound is heard.

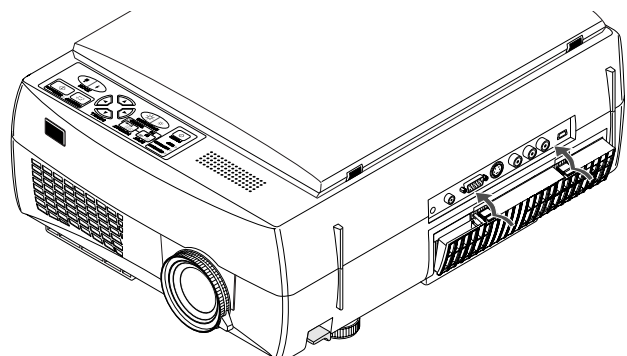

#### CAUTION

##### Air filter care and precautions

- Do not wash with water nor with hot water. Doing so will cause blockage.
- Do not wipe with a cloth or damp rag. Doing so will cause blockage.
- Be careful not to forget to install the air filter. Leaving the projector without a filter installed will allow dust to enter the inside of the projector and the image quality may worsen.
- When the air filter is damaged, be sure to replace it with a new air filter (available separately as the MPAF-C1). Use of the projector with a damaged filter will result in dust entering the inside of the projector and this will cause the image quality to worsen.

**NOTE:** The lamp will not light unless the air filter is installed.

# Troubleshooting

When you think the projector may be out of order, please first check the following matters before requesting repair.

Symptom	Please check this	Reference page
Power does not come on	<ul style="list-style-type: none"> <li>Is the power cable connected?</li> </ul>	E-21
Projection lamp does not light	<ul style="list-style-type: none"> <li>Is the lamp burned out?</li> <li>Is the lamp unit cover installed?</li> <li>Is the air filter installed?</li> <li>Is the internal temperature high? If so, the lamp will not light to protect the projector from damage.</li> <li>Is the lamp usage time in excess of 2000 hours?</li> </ul>	E-42 E-43 E-45 E-40 E-42
There is no image	<ul style="list-style-type: none"> <li>Has the connected input been selected?</li> <li>Is the cable of the connected equipment properly connected?</li> <li>Have "Brightness" and "Contrast" of the "Image adjustment" menu been set all the way to the minus side?</li> <li>Have you checked the functions of the personal computer?</li> </ul>	E-23 E-16, 20 E-36 E-18
Image is distorted	<ul style="list-style-type: none"> <li>Is the projector set up properly?</li> <li>Has keystone correction been applied?</li> </ul>	E-14 E-38
Image is blurred	<ul style="list-style-type: none"> <li>Has the focus been adjusted?</li> <li>Is the projection distance within the range that can be properly focused?</li> <li>Has keystone correction been applied?</li> <li>Is the lens cap attached?</li> </ul>	E-22 E-14 E-38 E-8
The image flickers	<ul style="list-style-type: none"> <li>Please adjust "Phase" of the "Sync adjustment" menu.</li> </ul>	E-37
The image is out of adjustment	<ul style="list-style-type: none"> <li>Are the settings of the "Sync adjustment" menu suitable?</li> </ul>	E-37
The color is not right	<ul style="list-style-type: none"> <li>Please adjust "Phase" of the "Sync adjustment" menu.</li> </ul>	E-37
There is no sound	<ul style="list-style-type: none"> <li>Is the volume adjustment set to the minimum?</li> </ul>	E-28
There is a snap sound from the cabinet	<ul style="list-style-type: none"> <li>This sound is associated with the minute expansion or shrinkage of the cabinet due to a change of the temperature. It has no effect on performance or anything else.</li> </ul>	–
The TEMP LED lights	<ul style="list-style-type: none"> <li>Follow the instructions on the "Fault Protection" measures page.</li> </ul>	E-40
The LAMP/COVER LED lights in red	<ul style="list-style-type: none"> <li>Is the air filter disengaged?</li> <li>Is the lamp unit cover disengaged?</li> <li>Is the lamp usage time in excess of 2000 hours?</li> </ul>	E-45 E-43 E-42
The remote control will not work	<ul style="list-style-type: none"> <li>Is the battery exhausted? Or is it weak?</li> <li>Is the remote control IR sensor exposed to illumination or other light?</li> <li>Is the remote control IR sensor blocked?</li> <li>Is an inverter device located close by?</li> </ul>	E-4, 13 E-13 E-13 E-13
At the time of personal computer input selection, the position of the video is shifted, or the display is compressed	<ul style="list-style-type: none"> <li>Please adjust using the "Sync adjustment" menu.</li> </ul>	E-37

# Repair Service

---

## Repair Service Procedure

- Before asking for repair service, check the Troubleshooting section on page E-46 once more. If this check confirms a problem, contact the dealer where you bought the product.
- When asking for repair service, provide your dealer with the following information:
  - Description of the problem (as many details as possible)
  - Date of purchase
  - Your Name
  - Your Address
  - Telephone number
  - Product name and model No. (written on the label at the bottom of the projector)

# Specifications

Model Name		iP-25	
Type		3 primary Color LCD Shutter Projection Type	
Main Part Specification	LCD Panel	Size	0.7 inches x 3 Panels, Aspect Ratio 4:3
		Drive System	Poly Silicon TFT Active Matrix with Micro Lens Array
		Number of Pixels	786,432 pixels (1,024 x 768 dots) × 3
		Arrangement	Stripe
	Projection Lens	Manual Zoom: 1 to 1.2x	
Optical Source		180W Super High-pressure Mercury Lamp	
Image Size		30-300 inches diagonal (projection distance 1.3 to 11.3 m)	
Color Reproducibility		Full color (16,770,000 colors)	
Brightness		2000 ANSI lumens	
Scan Frequency		Horizontal 21 to 68.7 kHz, Vertical 50 to 85 Hz	
Maximum Resolution	At RGB signal input	1,024 × 768 dots (Compressed display of 1,280 × 1,024 dots is possible.)	
Video Input	OHP	Scanner	2 Mega-pixels color CCD camera 288 mm × 216 mm (11.3 in × 8.5 in)
		PC (Analog RGB Input)	Signal system
	Video signal		Analog: 0.7Vp-p/75Ω
	Sync Signal		Separate/composite: TTL Level (positive/negative) Sync on green: 0.3 Vp-p (Negative)
	Video	Terminal Panel	15 pin Mini D-sub 1 ch
		Signal system	NTSC/PAL/SECAM/PAL-N/PAL-M/NTSC4.43
Audio Input	PC	Input Terminal	RCA Pin Jack 1 ch, S-Video (Mini DIN4-pin) 1ch
		Audio Signal	0.4Vrms/47KΩ
	Video	Input Terminal	Stereo Mini Jack 1 ch
		Audio Signal	0.4Vrms/47KΩ
USB Connector*		1 system USB connector (Mini B type)	
Audio Output		2W monaural	
Operating Range of Temperature and Humidity		Temperature: 0 to 35°C (32 to 95°F), humidity: 20 to 80% (no condensation)	
Power Source		100-120 / 220-240V AC , 50/60 Hz	
Power Consumption		290W (100-120V AC), 280W (220-240V AC)	
Input Current		2.9A (100-120V AC), 1.2A (220-240V AC)	
External Dimensions (mm/in)		310 (W) × 405(D) × 140(H) / 12.2 (W) × 15.9(D) × 5.5(H) (not including protrusions, Including the cover)	
Weight		5.6kg / 12.3lbs	
Accessories		Power Cable (3 m/3.3 yd), Remote Control, User's Manual, Battery (Coin-type lithium battery: CR2025), PC cable, Lens cap, Replacement air filter	
Regulation		UL Approved (UL 60950, CSA 60950) Meets FCC Class A requirements Meets AS/NZ CISPR22 Class A Meets EMC Directive (EN55022, EN55024, EN61000-3-2, EN61000-3-3) Meets Low Voltage Directive (EN60950, TUV GS Approved) 	

\* USB connectors are not guaranteed to work with all personal computers.

• Specifications and designs are subject to change without prior notice in order to improve the product.

LCD panels are inherently susceptible to pixel defects.

The specifications are subject to change without notice.



## Free Manuals Download Website

<http://myh66.com>

<http://usermanuals.us>

<http://www.somanuals.com>

<http://www.4manuals.cc>

<http://www.manual-lib.com>

<http://www.404manual.com>

<http://www.luxmanual.com>

<http://aubethermostatmanual.com>

Golf course search by state

<http://golfingnear.com>

Email search by domain

<http://emailbydomain.com>

Auto manuals search

<http://auto.somanuals.com>

TV manuals search

<http://tv.somanuals.com>