

StorageWorks by Compaq Modular SAN Array Fabric Switch 6

User Guide

Part Number 230934-002

June 2002 (Second Edition)

This guide is designed to be used as step-by-step instructions for installation and as a reference for operation, troubleshooting, and future upgrades.

COMPAQ

© 2002 Compaq Information Technologies Group, L.P.

Compaq, the Compaq logo, and StorageWorks are trademarks of Compaq Information Technologies Group, L.P. in the U.S. and/or other countries.

Microsoft, MS-DOS, Windows, and Windows NT are trademarks of Microsoft Corporation in the U.S. and/or other countries.

Compaq shall not be liable for technical or editorial errors or omissions contained herein. The information in this document is provided “as is” without warranty of any kind and is subject to change without notice. The warranties for Compaq products are set forth in the express limited warranty statements accompanying such products. Nothing herein should be construed as constituting an additional warranty.

Modular SAN Array Fabric Switch 6 User Guide

June 2002 (Second Edition)

Part Number 230934-002

Contents

About This Guide

Intended Audience	vii
Important Safety Information	vii
Symbols on Equipment	vii
Rack Stability.....	ix
Symbols in Text.....	ix
Text Conventions.....	x
Related Documents.....	x
Getting Help.....	x
Compaq Technical Support.....	xi
Compaq Website	xi
Compaq Authorized Reseller	xi

Chapter 1

Overview of the Switch

The MSA Fabric Switch 6	1-2
Features.....	1-3
Rear View of the Modular San Array 1000.....	1-4
Installation	1-5
Ethernet RJ-45 Cable	1-5
DB-9 Serial Cable	1-5
Hot-Pluggable	1-6

Chapter 2

Initial Configuration of the Switch

Configuration Overview.....	2-2
Using the Text-based UI to Configure the Switch	2-3
Connecting a Terminal to the Switch	2-3
Logging in to the Text-based UI.....	2-5
Accessing Networking Parameters	2-6
Accessing Management Parameters	2-10
Accessing the CLI.....	2-11
Exiting the Text-based UI.....	2-11
Resetting the Switch	2-11
Using the Array Configuration Utility-XE (ACU-XE) to Configure the Switch.....	2-12
Accessing the Switch Configuration Option of the ACU-XE	2-13
Initial Switch Configuration	2-16
Advanced Switch Configuration.....	2-18

Chapter 3

MSA Fabric Switch 6 Management Utility

Defining System Requirements.....	3-2
Launching the Management Utility.....	3-3
Describing the Console	3-4
Task Selection Toolbar	3-5
Status Panel.....	3-5
Main Management Panel	3-8
Using MSA Fabric Switch 6 Management Utility	3-15
Managing and Monitoring Individual Ports.....	3-15
Managing from the System Information Panel.....	3-31
Monitoring from the Device View	3-48
Session Configuration.....	3-49
Setting up Zoning	3-50

Chapter 4

Troubleshooting

Troubleshooting Guidelines.....	4-1
Troubleshooting the MSA Fabric Switch 6	4-2
Reading the Global Status Indicator.....	4-2
Reading the Ethernet Indicators	4-4
Reading the Port Indicators	4-6
Serial Communication Problems.....	4-6
Connections	4-6
Compaq-supported Small Form Factor Pluggables (SFP)	4-7
Fibre Channel Cables	4-7
Temperature Control.....	4-8
Preventative Maintenance Solutions.....	4-8

Appendix A

Regulatory Compliance Notices

Federal Communications Commission Notice	A-1
Federal Communications Commission Notice	A-2
Modifications	A-2
Cables.....	A-2
Canadian Notice (Avis Canadien)	A-2
European Union Notice	A-3

Appendix B

Electrostatic Discharge

Grounding Methods.....	B-2
------------------------	-----

Appendix C

Command Line Interface

Invoking the Command Line Interface	C-3
Using the Command Line Interface	C-4
Logging Out of the CLI	C-5
Exiting from CLI	C-5
Reset	C-5
Beacon	C-5
Setting up Zoning	C-37
Zoning Elements	C-37
Naming Rules for Zone Members, Zones, and Zone Sets	C-39
Zoning Limitations for Zone Members, Zones, and Zone Sets	C-39
Using the CLI to Configure Zoning	C-40

Appendix D

Laser Precautions and Fibre Cables

Laser Precautions	D-1
Fibre Channel Cable	D-2

Appendix E

Updating the Fabric Switch MSA Fabric Switch 6 Management Utility

Finding the MSA Fabric Switch 6 Management Utility Version Number	E-1
Downloading the Switch Management Utility Update	E-1
Updating the Switch using the Web Browser Interface	E-2
Updating the Switch using the Command Line Interface	E-2
Updating the Switch 6 using the Boot Menu	E-4

Index

About This Guide

This guide is designed to be used as step-by-step instructions for installation and as a reference for operation, troubleshooting, and future upgrades.

Intended Audience

This guide is intended for readers with a moderate level of SAN and system administration experience.

Important Safety Information

Before installing this product, read the *Important Safety Information* document provided.

Symbols on Equipment

The following symbols may be placed on equipment to indicate the presence of potentially hazardous conditions:



WARNING: This symbol, in conjunction with any of the following symbols, indicates the presence of a potential hazard. The potential for injury exists if warnings are not observed. Consult your documentation for specific details.



This symbol indicates the presence of hazardous energy circuits or electric shock hazards. Refer all servicing to qualified personnel.

WARNING: To reduce the risk of injury from electric shock hazards, do not open this enclosure. Refer all maintenance, upgrades, and servicing to qualified personnel.



This symbol indicates the presence of electric shock hazards. The area contains no user or field serviceable parts. Do not open for any reason.

WARNING: To reduce the risk of injury from electric shock hazards, do not open this enclosure



This symbol on an RJ-45 receptacle indicates a network interface connection.

WARNING: To reduce the risk of electric shock, fire, or damage to the equipment, do not plug telephone or telecommunications connectors into this receptacle.



This symbol indicates the presence of a hot surface or hot component. If this surface is contacted, the potential for injury exists.

WARNING: To reduce the risk of injury from a hot component, allow the surface to cool before touching.



These symbols, on power supplies or systems, indicate that the equipment is supplied by multiple sources of power.

WARNING: To reduce the risk of injury from electric shock, remove all power cords to completely disconnect power from the system.



Weight in kg
Weight in lb

This symbol indicates that the component exceeds the recommended weight for one individual to handle safely.

WARNING: To reduce the risk of personal injury or damage to the equipment, observe local occupational health and safety requirements and guidelines for manual material handling.

Rack Stability



WARNING: To reduce the risk of personal injury or damage to the equipment, be sure that:

- The leveling jacks are extended to the floor.
 - The full weight of the rack rests on the leveling jacks.
 - The stabilizing feet are attached to the rack if it is a single-rack installation.
 - The racks are coupled in multiple-rack installations.
 - Only one component is extended at a time. A rack may become unstable if more than one component is extended for any reason.
-

Symbols in Text

These symbols may be found in the text of this guide. They have the following meanings.



WARNING: Text set off in this manner indicates that failure to follow directions in the warning could result in bodily harm or loss of life.



CAUTION: Text set off in this manner indicates that failure to follow directions could result in damage to equipment or loss of information.

IMPORTANT: Text set off in this manner presents clarifying information or specific instructions.

NOTE: Text set off in this manner presents commentary, sidelights, or interesting points of information.

Text Conventions

This document uses the following conventions:

- *Italic type* is used for complete titles of published guides or variables. Variables include information that varies in system output, in command lines, and in command parameters in text.
- **Bold type** is used for emphasis, for onscreen interface components (window titles, menu names and selections, button and icon names, and so on), and for keyboard keys.
- `Monospace typeface` is used for command lines, code examples, screen displays, error messages, and user input.
- Sans serif typeface is used for uniform resource locators (URLs).

Related Documents

For additional information on the topics covered in this guide, refer to the following documentation:

- *StorageWorks by Compaq Modular SAN Array 1000 User Guide*, part number 230941
- *StorageWorks by Compaq Modular SAN Array 1000 Installation Overview*, part number 230935

Getting Help

If you have a problem and have exhausted the information in this guide, you can get further information and other help in the following locations.

HP Technical Support

In North America, call the HP Technical Support Phone Center at 1-800-652-6727. This service is available 24 hours a day, 7 days a week. For continuous quality improvement, calls may be recorded or monitored. Outside North America, call the nearest HP Technical Support Phone Center. Telephone numbers for worldwide Technical Support Centers are listed on the HP website, www.hp.com.

Be sure to have the following information available before you call HP:

- Technical support registration number (if applicable)
- Product serial number
- Product model name and number
- Applicable error messages
- Add-on boards or hardware
- Third-party hardware or software
- Operating system type and revision level

HP Website

The HP website has information on this product as well as the latest drivers and flash ROM images. You can access the HP website at www.hp.com.

HP Authorized Reseller

For the name of your nearest HP authorized reseller:

- In the United States, call 1-800-345-1518.
- In Canada, call 1-800-263-5868.
- Elsewhere, see the HP website for locations and telephone numbers.

Overview of the Switch

This guide provides specific information for installing and configuring the MSA Fabric Switch 6 and its component parts.

Table 1-1: Organization of this Guide

For information about	See
Overview of the Switch	Chapter 1
Initial Configuration of the Switch	Chapter 2
MSA Fabric Switch 6 Management Utility	Chapter 3
Troubleshooting	Chapter 4
Regulatory Compliance Notices	Appendix A
Electrostatic Notices	Appendix B
Command Line Interface	Appendix C
Laser Precautions	Appendix D
Updating the MSA Fabric Switch 6 Management Utility	Appendix E



WARNING: To reduce the risk of personal injury or damage to the equipment, refer to the user documentation supplied with the server and observe the appropriate safety precautions.

The MSA Fabric Switch 6

The MSA Fabric Switch 6 is an integrated six-port module, featuring a 12 Gbps switch engine that enables full duplex non-blocking performance on all ports.

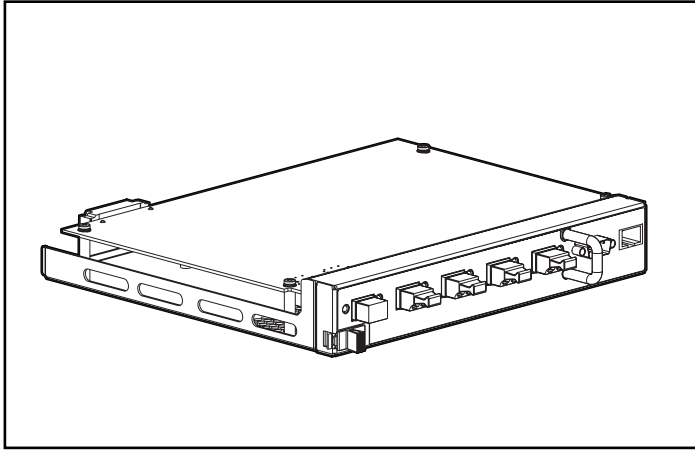

Figure 1-1: The MSA Fabric Switch 6

Features

The MSA Fabric Switch 6 includes:

- A main board enclosing the 12 Gbps switching engine
- Microprocessor and other hardware logic to support the switch software agents
- MSA Fabric Switch 6 Management Utility
 - Full Duplex Communications - A pair of nodes can simultaneously send and receive data for an aggregate of 2 Gbps
 - Automatic Port Bypass - Improves SAN reliability by automatically bypassing errant ports
- Global Status Indicator (GSI)
- RS-232 serial interface port for configuring the MSA Fabric Switch 6
- 10-base T Ethernet port for communications to host resident management software applications
- Null modem cable
- Five external 2/1 Gbps ports, 1 internal 2/1 Gbps port
- Auto switch between 1 and 2 Gbps
- Array Configuration Utility-XE (ACU-XE) configuration support
- Compaq Insight Manager (CIM-XE) launch of the Management Utility

Rear View of the Modular San Array 1000

Figure 1-2 is an illustration of the rear panel of the MSA1000 with an MSA Fabric Switch 6 installed.

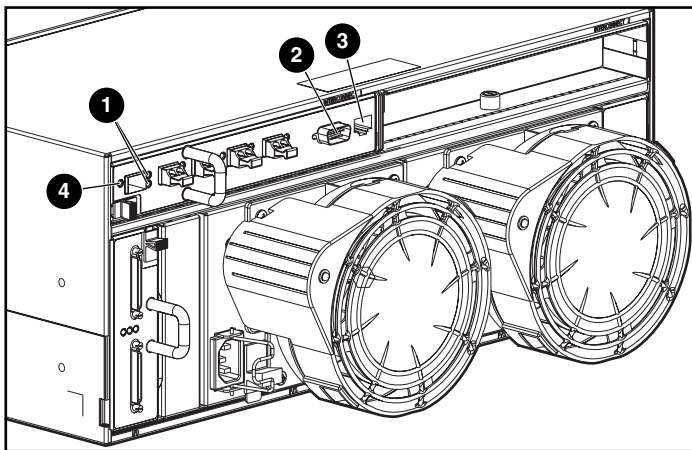

Figure 1-2: MSA1000 rear panel with a Fabric Switch 6

Item	Description	Function
❶	Port Link Indicators	See indicators table in Chapter 4, "Troubleshooting."
❷	RS-232 DB-9 Serial Port	A male serial port that may be connected to a host system with a standard 9-pin female to 9-pin female null modem cable. This port can be used to perform initial configuration or local management diagnostic tasks.
❸	RJ-45 Ethernet connector	Ethernet connector to connect the device to a network for management purposes.
❹	Global Status Indicator	The Global Status Indicator provides a visual reference to the status of the switch. See the indicators table in Chapter 4, "Troubleshooting," for more information.

Installation

Before the MSA Fabric Switch 6 can communicate with Compaq-managed devices, all devices must be properly connected and powered on.

Ethernet RJ-45 Cable

This connector is provided for management through Simple Network Management Protocol (SNMP). By default, the MSA Fabric Switch 6 is configured to use an IP address of 127.0.0.1. To change this IP address, use ACU-XE, a terminal, or a terminal emulator connected to the DB-9 serial port. Refer to Chapter 2, "Initial Configuration of the Switch," for more detailed information on this subject.

DB-9 Serial Cable

This connector is provided for advanced configuration and management.

The MSA Fabric Switch 6 is designed to function directly out of its shipping container with no special configuration required. However, you have the ability to configure and monitor various aspects of the MSA Fabric Switch 6 by using ACU-XE or CIM-XE or by connecting a terminal or terminal emulator to the serial port. See Chapter 2, "Initial Configuration of the Switch," for more information on using this interface.

Hot-Pluggable

The MSA Fabric Switch 6 is hot-pluggable. The unit can be installed and replaced without power-cycling the MSA1000.

When adding or replacing a switch, allow sufficient time to complete the power-on self-tests (POST) and configuration tasks before using.

To power on the unit properly:

1. Power on the MSA1000.

On power up, the switch will run several POST tests and the GSI indicator will display changing patterns (refer to the section “Reading the Global Service Indicator” in Chapter 4, “Troubleshooting”).

2. Power on I/O device(s).
3. Verify that the storage device(s) are visible to the host(s).
4. Start Applications.

Before the MSA Fabric Switch 6 can communicate with Compaq-managed devices, all devices must be properly configured, connected, and powered up. See Chapter 2, “Initial Configuration of the Switch,” for installation instructions.

Initial Configuration of the Switch

This chapter details the procedures used to initially configure the MSA Fabric Switch 6. Preliminary switch configuration includes entering the Ethernet and the SNMP settings.

Two configuration methods are available:

- Using the text-based user interface to configure the switch
- Using the Array Configuration Utility-XE (ACU-XE) to configure the switch

Configuration Overview

When a switch is initially connected to a network, the network does not recognize it and does not know its IP address. Accessing the switch and entering the Ethernet and SNMP settings assigns the switch a location and makes it available to the network.

After the switch is accessible, additional parameters must be entered. These secondary configuration tasks can be performed from four different user interfaces, including the text-based user interface (text-based UI), Command Line Interface (CLI), the ACU-XE, and the Compaq MSA Fabric Switch 6 Management Utility.

The text-based UI can be used for the initial configuration tasks and the CLI can be accessed from this interface to perform advanced configuration tasks.

The CLI of the switch provides access to extensive management and monitoring functions and is available directly through the serial port in the front of the switch or remotely through the switch's Ethernet interface using telnet. During initial set-up, it is accessed through the text-based UI. Subsequently, the system defaults to the CLI or the text-based UI, depending on which interface was used last. For information on the CLI, refer to Appendix C, "Command Line Interface."

The ACU-XE is a web-based user interface primarily used to configure the array controllers and hard drive arrays of the MSA1000. In addition, the ACU-XE can be used to configure the switch. Instructions for configuring the switch using the ACU-XE are included in this chapter. For information on using the ACU-XE to configure the storage, refer to the *StorageWorks by Compaq Modular SAN Array 1000 User Guide* or the *Compaq Array Configuration Utility XE User Guide*.

The MSA Fabric Switch 6 Management Utility provides most of the functions available in the text-based UI and the CLI, but in a user-friendly, web-based, graphical interface. It is accessible from Compaq Insight Manager (CIM-XE) or any workstations equipped with a web browser. For more information, refer to www.compaq.com/storageworks.

Using the Text-based UI to Configure the Switch

The text-based UI of the switch is available directly through the serial port in the front of the switch. After the Ethernet settings are entered, the text-based UI can be accessed remotely through the switch's Ethernet interface using telnet. With the following exceptions, all functions of the menu interface are available either directly or through telnet.

- The telnet interface is available only after the MSA Switch is completely booted. This means the results of the initialization tests are not viewable and if a reset is issued, the telnet connection is terminated.
- Users are unable to change the password over the telnet interface.

Another difference between using the serial port interface and telnet is that when using telnet, you can only get access to the switch after it has started up and has initialized its network parameters. Consequently, you must have a directly-connected terminal to initially configure network parameters and to view the power-up information of the MSA Switch.

Connecting a Terminal to the Switch

NOTE: This process uses a computer running on Microsoft Windows NT 4.0 or later. However, the switch can communicate with any operating system that utilizes a terminal emulator. If your computer uses another operating system, be sure that the baud rate, data bits, stop bits, parity, and terminal emulation are set for the selected serial port as specified in this procedure.

To directly connect a terminal to the MSA Switch:

1. Make sure there is power to the switch and attach a terminal or terminal emulator.
2. Connect a server serial port to the switch's DB-9 serial port.
3. Power on the server (if it is not already on).
4. Access the terminal emulator on the server. In Windows NT 4.0, select

Start→Programs→Accessories→HyperTerminal

5. Set up the properties for the terminal connection.
In Windows NT 4.0:
 - a. Double-click the **Hypertrm** icon.
 - b. Enter a name for the connection in the **New Connection** dialog box, select an icon to represent the switch for future use, and click **OK**.
The **Connect To** dialog box is displayed.
6. From the **Connect using** drop-down menu, select the communications port assigned to the serial port (for example, *COM1*, *COM2*) and click **OK**. In the properties dialog box, enter the following port settings and select **OK**.

Table 2-1: Default Serial Port Settings

Type	Setting
Bits per second (baud rate)	38,600
Data bits	8
Parity	None
Stop bits	1
Flow control	None

7. Select File→Properties to show the connection properties dialog box. Select the **Settings** tab. From the **Emulation** pull-down menu, select *VT100* and click **OK**.
8. Power ON all peripheral device(s).
9. Wait at least ten seconds and power cycle the MSA1000. The switch sends a series of Power-on Self-Test (POST) messages in HyperTerminal.

Logging in to the Text-based UI

Upon connection to the switch or completion of the start-up sequence, you must log into the MSA Switch to access the management functions. To do this, you must login as “user” and enter the password assigned to the switch.

The default login variables assigned at the factory are:

```
Login: user
Password: ADMIN
```

To access the text-base UI:

1. At the **Login** prompt, enter *user* as the login variable.
>Login: user
2. At the **password** prompt, enter the assigned password.
>Password: ADMIN

Upon successful login, the main menu is displayed. Figure 2-1 is an illustration of the initial Login menu.

```
Embedded Switch - 6 Port
Model number:          229967-001
Firmware version:      PXX.X
Selftest status:      passed

2.  Networking settings
3.  Management settings
4.  Command line interface
5.  Logout
6.  Reset switch
```

Figure 2-1: Login menu

The main menu contains a brief summary of the status of the switch, including the model number, the firmware version, and whether it passed its self-test.

NOTE: If the text-based UI from the previous connection was logged out while in the CLI, the CLI prompt is displayed. To return to the text-menu interface from the CLI prompt, enter exit at the prompt.

Accessing Networking Parameters

Select option **2. Networking parameters** to access the Network Parameter menu, which is shown Figure 2-2. The first option in this menu allows the user to return to the main menu. Any changes made are reset to the previous value.

The second, third, and fourth parameters are used to configure the Ethernet settings for the MSA Switch. All these parameters must be set appropriately for the site before the MSA Switch can be managed over the Ethernet and connected to using telnet.

```
Network Settings Menu
1.  Return to main menu
2.  Set IP address      [current: 127.0.0.1]
3.  Set subnetwork mask [current: 255.255.255.0]
4.  Set gateway address [current: 0.0.0.0]
5.  Save modifications and reset switch to activate
```

Figure 2-2: Network Parameters menu

Setting the IP Address

Select option **2. Set IP address** in the Network Parameters menu to call up the IP Address menu shown in the figure below. It displays the current IP address. The default (127.0.0.1) is set at the factory. This address should be changed to an IP address appropriate to your site. Check with the network administrator if uncertain of what this should be. Check with your network administrator before using the default address, as it is a special IP address used for testing purposes only.

```
Network Settings Menu

1.  Return to main menu
2.  Set IP address      [current: 192.168.111.100]
3.  Set subnetwork mask [current: 255.255.255.0]
4.  Set gateway address [current: 0.0.0.0]
5.  Save modifications and reset switch to activate
>2

IP Address Menu

Current IP address: 192.168.111.100
1.  to return to previous menu
or enter new IP address in dotted decimal notation, e.g.
1.2.3.4
```

Figure 2-3: Network Parameters – Set IP address

Setting the Subnetwork Mask

Select option **3. Set subnetwork mask** in the Network Parameters menu to call up the Subnetwork Mask Menu. The default subnetting mask is a Class C mask as shown in the figure below. This mask will work in many installations, as Class C IP networks are by far the most common. The best source of the correct mask is your local network administrator.

```
Network Settings Menu
1.  Return to main menu
2.  Set IP address      [current: 192.168.111.100]
3.  Set subnetwork mask [current: 255.255.255.0]
4.  Set gateway address [current: 0.0.0.0]
5.  Save modifications and reset switch to activate
>3

IP Subnetwork Mask Menu

Current subnetwork mask: 255.255.255.0
1.  Return to previous menu
    or enter new subnetwork mask in dotted decimal notation,
    e.g. 1.2.3.4
```

Figure 2-4: Network Parameters menu – Set subnetwork mask

Setting the Gateway Address

Select option **4. Set gateway address** in the Network Parameters menu to call up the Set Gateway Address menu, which is shown in Figure 2-5.

The gateway is a computer or Ethernet router that connects your segment of the Ethernet to other segments. This is also true if using telnet to communicate with the MSA Fabric Switch 6 over the Ethernet from systems on other segments. In both of these cases, the MSA Fabric Switch 6 will need the IP address of the gateway system in order for it to function. Direct questions about gateways to your local network administrator.

```
Network Settings Menu
1.  Return to main menu
2.  Set IP address      [current: 192.168.111.100]
3.  Set subnetwork mask [current: 255.255.255.0]
4.  Set gateway address [current: 0.0.0.0]
5.  Save modifications and reset switch to activate
>4

IP Gateway Address Menu

Current gateway address : 0.0.0.0
1.  Return to previous menu
    or enter new gateway address in dotted decimal notation,
    e.g. 1.2.3.4
```

Figure 2-5: Network Parameters menu – Set gateway address

Saving Modifications

Though a number of parameters may have been set in the Network Parameters menu, none are permanent until the **Save modifications and reset switch to activate** option is chosen. This saves the parameters in non-volatile memory and reboots the switch with the new parameters in effect.

Accessing Management Parameters

Select option **3. Management settings** in the main menu to call up the Management Settings Menu, which is shown in Figure 2-6.

Unlike the Network Parameters menu, changes made in this menu become effective as soon as they are made. There is no need to reset the switch.

```
Management Settings Menu

1.   Return to main menu
2.   Set SNMP get community name   [current: public]
3.   Set SNMP set community name   [current: private]
4.   Set SNMP trap community name  [current: SNMP_trap]
5.   Change password
```

Figure 2-6: Management Options menu

Options include:

1. Return to main menu allows the user to return to the main menu.

2. Set SNMP get community string calls up the SNMP Get Community Name menu. This allows the user to restore the default SNMP get community name or to enter a new SNMP get community name.

3. Set SNMP set community string calls up the SNMP Set Community Name menu. This allows the user to restore the default SNMP set community name or to enter a new SNMP set community name. The SNMP Set community string is the password that any SNMP client must use to write settings to the SNMP agent on the MSA Fabric Switch 6. This name can be any ASCII string desired. The factory default is “private.”

4. Set SNMP trap community string calls up the SNMP Trap Community Name menu. The SNMP Trap community string is the password that any SNMP client must use to poll the SNMP agent on the MSA Fabric Switch 6 for SNMP traps. This name can be any desired ASCII string. The factory default is “SNMP_trap.”

To change the SNMP Trap Community string, type the new name at the command prompt and press the **Enter** key.

5. Change Password is used to enter a new password. There will be verification to test if this has been successfully completed or not. For security reasons, the password can only be changed through the serial port. It cannot be changed through a telnet connection over the Ethernet.

The password can be set to null (that is, a carriage return) or an alphanumeric password can be used with up to eight characters. The space cannot be part of the password as it is used to separate the first and second copies of the new password.

NOTE: If the new password is forgotten, contact your network administrator. You will need the unit's serial number and Ethernet MAC address.

Accessing the CLI

Select option **4. Command line interface** on the main menu, to call up the command line interface. This gives the user the ability to change parameters. These parameters should only be modified by a knowledgeable user in order to modify the MSA Switch operational parameters, to set up policies, as well as to troubleshoot problems.

The complete Command Line Interface is outlined in Appendix C, "Command Line Interface."

Exiting the Text-based UI

The user can log out of the MSA Switch by selecting option **5. Logout** in the main menu. The original login prompt is redisplayed.

Resetting the Switch

Select option **6. Reset Switch** in the main menu to reboot the switch. This should not be done in a haphazard manner as all Fibre Channel connections provided by the switch can be affected and any management data stored in the switch will be erased.

Using the Array Configuration Utility-XE (ACU-XE) to Configure the Switch

When using the ACU-XE to initially configure the switch, depending on the controller's settings and the current switch configuration, you will be shown various options. The ACU-XE will prompt for information through specific screens, allowing changes before they are saved.

In addition to accessing the ACU-XE, the switch configuration process is separated in to two parts:

- Initial switch configuration
- Advanced switch configuration

As discussed previously, initial switch configuration includes setting the IP address, Subnet Mask, and Default Gateway of the switch (and the redundant switch, if installed). Until these Ethernet and SNMP parameters are entered, a Web Browser cannot find or connect to the switch.

Advanced switch configuration includes managing and monitoring ports, setting up zoning, and upgrading the switch firmware. Advanced configuration tasks are performed in using the MSA Fabric Switch 6 Management Utility. A link to this utility is provided in the ACU-XE.

NOTE: The switch configuration utility Web link to the MSA Fabric Switch 6 Management Utility is present only if the selected controller supports this feature.

NOTE: In the following screen examples, the configuring server's IP address is 10.100.100.14. One switch has an IP address of 10.100.100.10 and the other switch's IP address is 10.100.100.11.

Accessing the Switch Configuration Option of the ACU-XE

The ACU-XE can be started from the **Compaq Web Based Management** screen or by selecting **Start - Programs - Compaq System Tool - Compaq Array Configuration XE**.

Figure 2-7 is an example of the Compaq Web-Based Management screen.

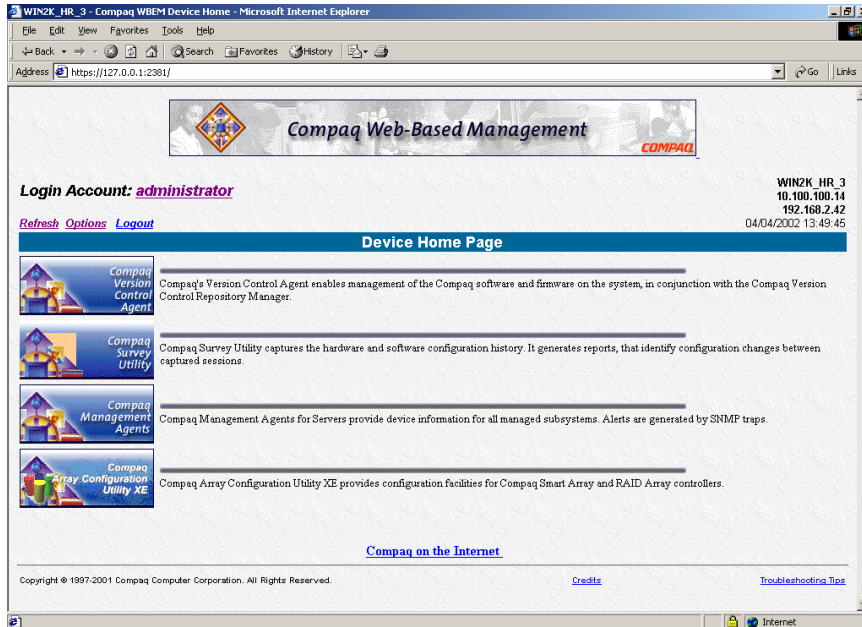

Figure 2-7: Compaq Web-Based Management screen

To start the ACU-XE from the Web-based Management screen:

1. Select Compaq Array Configuration Utility XE.

The ACU-XE main screen is displayed. See Figure 2-8 for an illustration of the ACU-XE main screen.

2. In the main ACU-XE screen, select an MSA1000 Controller from the controller list in the left column of the screen.

Three configuration methods are displayed at the bottom portion of the screen:

- **Assisted Configuration** is used to configure the controller.
- **Advanced Configuration** is used to configure the controller.
- **Switch Configuration** is used to configure the switch.

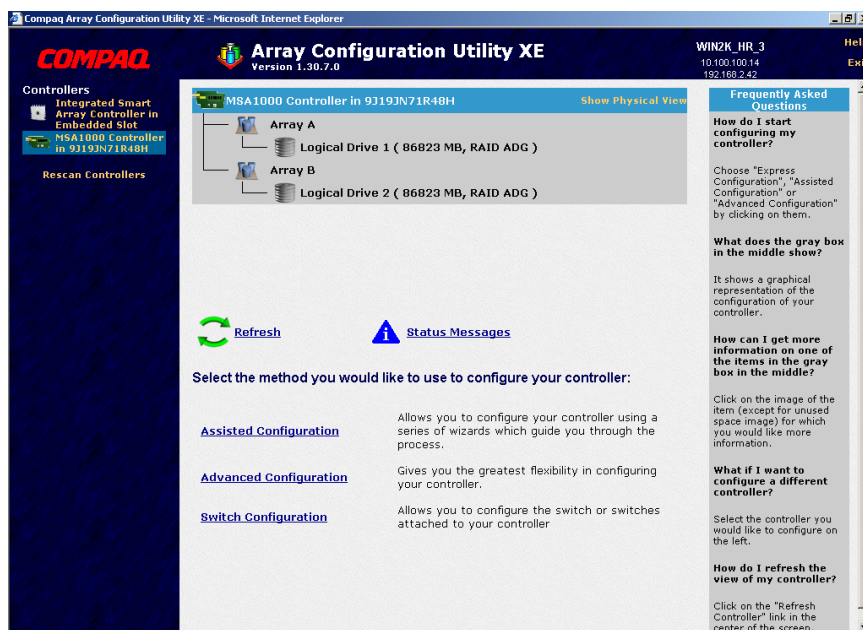

Figure 2-8: ACU-XE main screen

3. Select **Switch Configuration**.

All available switches detected by the ACU-XE for the selected controller are listed.

In the example shown in Figure 2-9, two switches were detected.

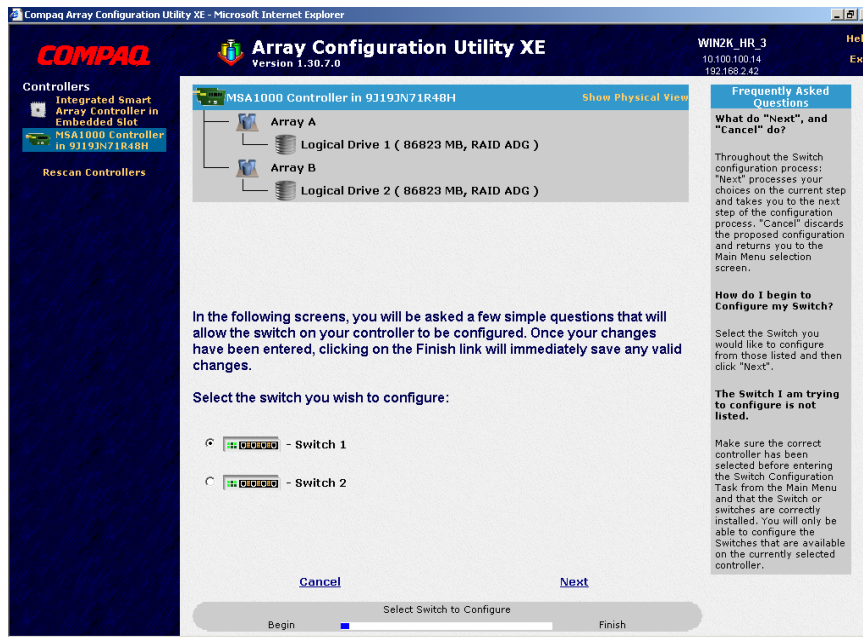

Figure 2-9: Switch selection

4. Select a switch to configure.

Initial Switch Configuration

After a switch is selected in the Switch Configuration screen, available configuration tasks for that switch are listed. See Figure 2-10 for an illustration of these configuration task options.

During the initial configuration of the switch, only one option is displayed. If the switch has already been configured and is active, additional tasks are displayed. These additional tasks are discussed in the following section, “Advanced Switch Configuration.”

To initially configure the switch:

1. Select **ACU-XE Switch Configuration**.

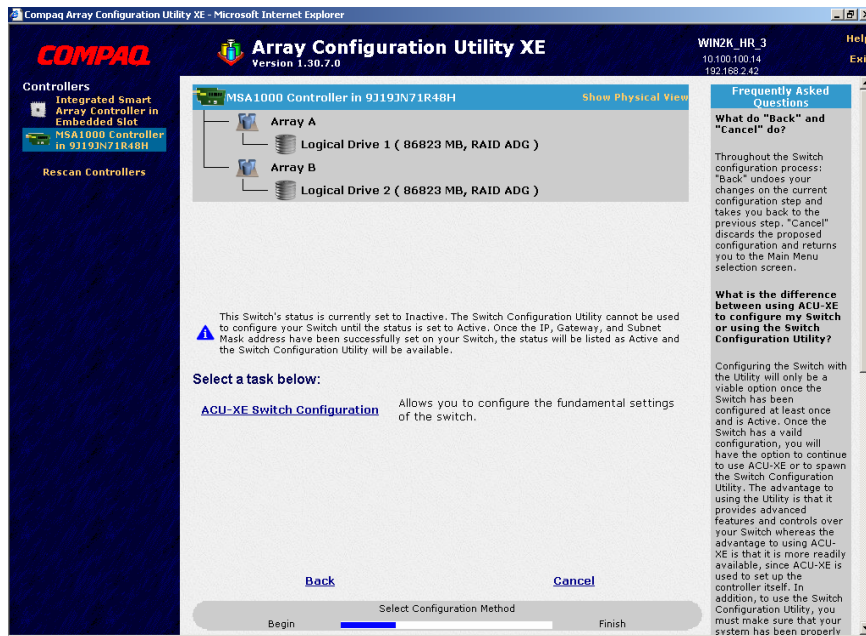

Figure 2-10: Initial Switch Configuration task option

An input screen is displayed. See Figure 2-11.

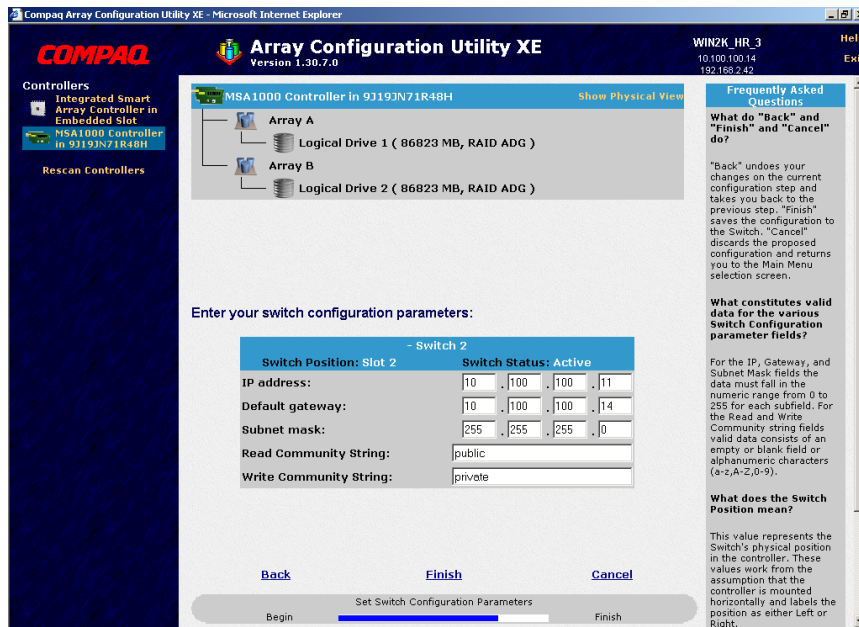

Figure 2-11: Switch parameters input screen

2. Enter the following information:
 - IP Address
 - Default Gateway
 - Subnet Mask
 - Read and Write Community strings
3. Click **Finish** to save the settings.
4. Repeat these procedures to set up another switch, if necessary.

Advanced Switch Configuration

After the initial configuration of the switch is completed, additional switch configuration tasks become available.

As illustrated in Figure 2-12, links to the Switch Configuration Utility are displayed for each switch. The Switch Configuration Utility is part of the MSA Fabric Switch 6 Management Utility that resides on the switch itself.

Parameters more advanced than those offered by ACU-XE are available in the Management Utility.



Figure 2-12: Advanced switch configuration options

NOTE: Before using the Web-based Switch Configuration Utility, verify that the networking cables have been connected between the management computer running ACU-XE and the LAN management ports on the switch(es), usually through a Hub. Compaq recommends using the PING command to ensure connectivity before selecting the Link.

MSA Fabric Switch 6 Management Utility

This chapter describes how to use the Management Utility on the MSA Fabric Switch 6. The following sections describe the process to launch the Management Utility on your switch:

- Defining System Requirements
- Launching the Management Utility
- Describing the Console
- Using the Management Utility

Defining System Requirements

The MSA Fabric Switch 6 Management Utility runs as a Java applet in a Netscape or Microsoft web browser and works with the versions shown below:

- Microsoft Internet Explorer version 5.5 or later
- Netscape Navigator version 4.75 or later
- Java Runtime Environment, Standard Edition, version 1.3.1 or later

The Java Plug-in must be already installed or be downloaded from the web or installed from Modular SAN Array 1000 Support Software CD-ROM.

To download the Java plug-in from the Web:

1. Go to <http://java.sun.com/> using Netscape Navigator or Internet Explorer.
2. Select J2SE technology.
3. Select J2SE downloads.
4. Scroll down the list and select J2RE-1.3.1 or later (includes Java Plug-in 1.3.1 with bundled HTML Converter).
5. Follow the download instructions.

To install Java plug-in from the MSA1000 Support Software CD:

1. Insert the MSA1000 Support Software CD in CD drive of your Server.
2. Select **Browse CD Contents**.
3. Navigate to and select the **Misc** folder.
4. Click **Windows_J2RE_Plug-in_1-4.exe** and follow the instructions.

Launching the Management Utility

To access your MSA Fabric Switch 6 using the Management Utility, you must configure it with an IP address using the Array Configuration Utility-XE (ACU-XE), as described in the section titled “Configuring your IP address,” and be connected to an IP network. Once configured, use the following procedure to launch the utility:

1. Use Compaq Insight Manager (CIM XE) or enter the IP address of the switch you want to manage into the web browser’s address box.
2. Once the Utility is launched, enter the SNMP “Read Community” and “Write Community” strings into the appropriate test boxes.

NOTE: These strings are case-sensitive.

3. Click the **OK** button.

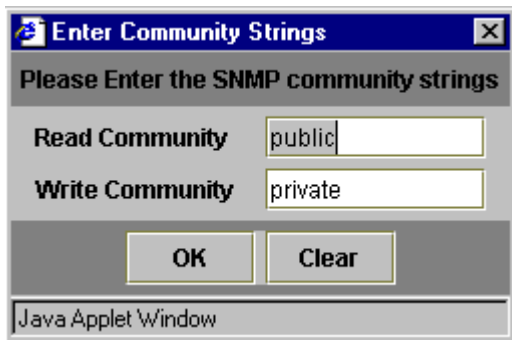

Figure 3-1: SNMP screen

NOTE: If the display properties on your computer system are set to “256 colors,” the Community Strings window will appear patterned and unclear. Change your display properties setting to either “True Color (32 bit)” or “High Color (16 bit)” for a sharp, clear image. You will find the display properties setting under Start\Settings\Control Panel\Display\Settings or right-click your desktop and select Active Desktop\Customize\Settings.

Describing the Console

The Management Utility provides a web-browser-based user interface so the MSA Fabric switch 6 can be easily managed. The opening window, as shown in the figure below, consist of three sections:

- Task Selection Toolbar
- Status Panel
- Main Management Panel

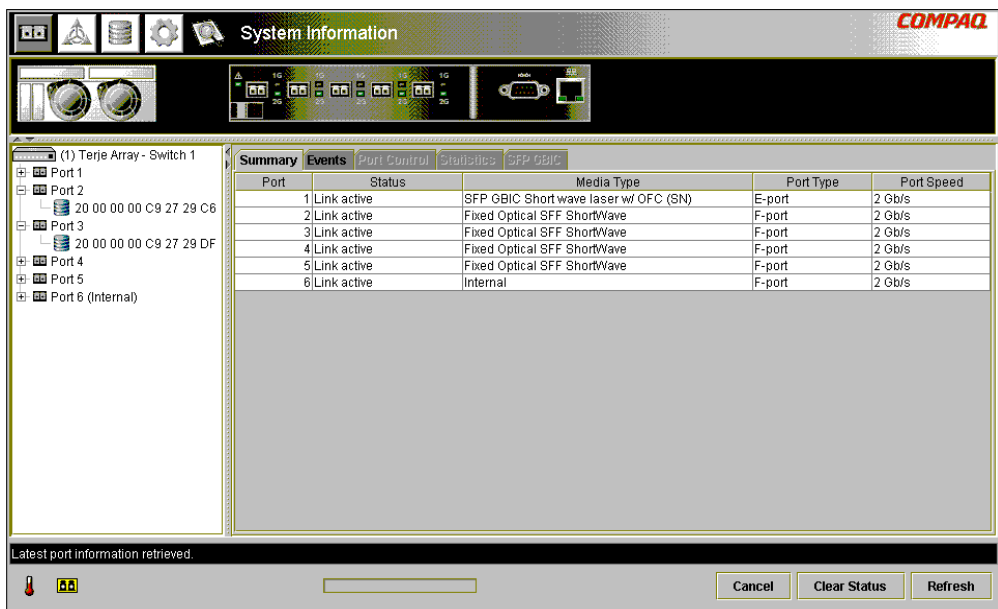

Figure 3-2: Console screen

Task Selection Toolbar

The Task Selection toolbar is comprised of five buttons and is located in the upper left corner of the screen. Selecting one of these buttons determines which of the management tasks you will operate using the Management Utility.

Figure 3-3 is sample of the Task Selection toolbar.



Figure 3-3: Task selection toolbar

Status Panel

The Status Panel is located at the bottom of the console screen and is shown in Figure 3-4. It is comprised of the following four elements:

- Switch Status Indicators
- Message Text Line
- Progress Indicator Bar
- Control Buttons, including **Cancel**, **Clear Status**, and **Refresh**.



Figure 3-4: Status panel

Switch Status Indicators

The switch indicators in the Status Panel display the operating condition of the switch, as described in the following table.

Table 3-1: Switch Status Indicators

TEMP	Normal State	Normal temperature operation. The operating temperature must be kept between 10 and 40 degrees Celsius (between 50 and 104 degrees Fahrenheit).
	Blinking Amber	Chassis Temperature is in a Fault State and has not been acknowledged. Clicking the icon brings up a display with more information about the chassis operating condition and stops the icon from blinking. The icon will also stop blinking if you click the Clear Status button.
	Amber	Chassis Temperature is in a Fault State and has been acknowledged by clicking the icon or clicking the Clear Status button. A Chassis Temperature icon in the “Amber” fault state will not return to the “Normal State” until the fault condition is corrected.
PORTS	Normal State	Normal port operation.
	Blinking Amber	One or more ports are in a Fault State and have not been checked. Clicking the icon brings up a display with more information about the ports operating condition and stops the icon from blinking. The icon will also stop blinking if you click the Clear Status button.
	Amber	One or more ports are in a Fault State and have been checked by clicking the icon or clicking the Clear Status button. A Ports icon in the “Amber” fault state will not return to the “Normal State” until the fault condition is corrected.

Message Text Line

The Message Text Line displays important information. This information can include what events have occurred, what activities are being performed, and what error messages are issued (in real-time).

The following table lists the error messages shown on the Message Text Line. To view detailed information about an error message, select the **System Information** button and then the Events Tab or select the **Port Information** button then the Events Tab.

Table 3-2: Message Text Line

EventPostFault	System event detected	Alert
EventTempFaultAct	System event detected	Alert
EventTempFaultDeact	System event detected	Alert
EventPortStatus	Port event detected	Notify
EventRtChange	Route event detected	Notify
EventNsChange	Name server event detected	Notify

Progress Indicator Bar

The Progress Indicator bar displays the percentage of progress completed during a transfer of information between the MSA Fabric Switch 6 and StorageWorks Management Utility, such as during a retrieval, refresh, or update action.

Control Buttons

Three Control buttons are located next to the Progress Indicator bar. Their functions are described in the following table.

Table 3-3: Control Buttons

Clear Status	Clears the information in the message and progress indicator areas. Switch Status Indicators that are currently in the “Blinking Amber” state will be set to a non-blinking “Amber” state. The indicators will not return to the “Normal State” until the fault condition is corrected.
Cancel	Cancels the current activity.
Refresh	Contacts the MSA Fabric switch 6 being monitored and refreshes the current display with current configuration information. Clicking this button does not update information for other Switches that are not currently being displayed.

Main Management Panel

The Main Management panel is the section of the console that is used for most management operations. The content of this panel is determined by one of the following buttons:

- Port Information
- System Information
- Device View
- Session Configuration
- Help

Port Information

When the **Port Information** button is selected from the Task Selection toolbar, the Port Information window is displayed as shown in the following figure. This display consists of a graphic representation of the switch being monitored at the top of the window, a tree representation of the switch, its ports, and connected devices in the left portion of the window, and a set of five tabbed configuration panels.

- Port Summary Tab
- Port Events Tab
- Port Control tab
- Port Statistics Tab
- SFP Tab

If you select the switch from the menu tree, the Summary and Events tabs will be available while the other tabs will be grayed out and unavailable. If you select a port from either the switch graphic at the top of the window or the menu tree, the Configuration, Statistics, and SFP tabs become available. These contain management information about the port selected. The SFP tab will only be displayed if SFP information is available for the port.

NOTE: No SFP tab will be displayed when an SFP is not installed in the switch or when an installed SFP does not make any information available.

In addition, the indicators that are displayed on the switch graphic reflect the indicators that are configured on the switch and display the same status that is currently on the switch being monitored.

The screenshot displays the 'System Information' window for a Compaq switch. The left panel shows a tree view of the switch configuration, including ports 1 through 6. The right panel shows a table of port information under the 'Summary' tab.

Port	Status	Media Type	Port Type	Port Speed
1	Link active	SFP GBIC Short wave laser w/ OFC (SN)	E-port	2 Gb/s
2	Link active	Fixed Optical SFF ShortWave	F-port	2 Gb/s
3	Link active	Fixed Optical SFF ShortWave	F-port	2 Gb/s
4	Link active	Fixed Optical SFF ShortWave	F-port	2 Gb/s
5	Link active	Fixed Optical SFF ShortWave	F-port	2 Gb/s
6	Link active	Internal	F-port	2 Gb/s

At the bottom of the window, there is a status bar with the text 'Latest port information retrieved.' and three buttons: 'Cancel', 'Clear Status', and 'Refresh'.

Figure 3-5: Port information (shown in the left panel)

System Information

When the **System Information** button is selected from the Task Selection toolbar, you can manage and monitor global parameters for the switch. It provides a set of tabbed panels that provide access to a set of 8 switch management functions and is displayed in the following figure.

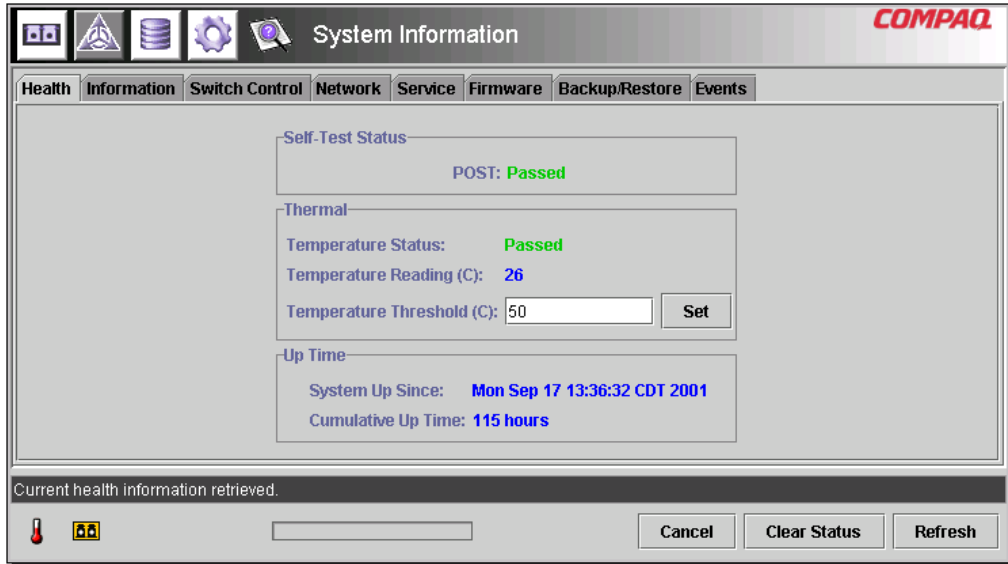

Figure 3-6: System information window

Device View

When the **Device View** button is selected, a table displays information for connected devices, as shown in the following figure. The devices displayed in the table can be filtered by selecting the switch, a port, or a device from the tree. Selecting the switch will show all the devices, selecting a port will show only the devices connected to that port, and selecting a device will show only that device.

Domain	Port	Port ID	Port Type	Node WWN	Port WWN
1	2	010200	N-port	20 00 00 00 C9 27 29 C6	10 00 00 00 C9 27 29 C6
1	3	010300	N-port	20 00 00 00 C9 27 29 DF	10 00 00 00 C9 27 29 DF
1	4	010400	N-port	20 00 00 00 C9 27 29 06	10 00 00 00 C9 27 29 06
1	5	010500	N-port	20 00 00 00 C9 27 29 C5	10 00 00 00 C9 27 29 C5
1	6	010600	NL-port	50 08 05 F3 00 00 0A 80	50 08 05 F3 00 00 0A 81
2	1	020100	N-port	20 00 00 00 C9 27 25 B9	10 00 00 00 C9 27 25 B9
2	2	020200	N-port	20 00 00 00 C9 27 29 B0	10 00 00 00 C9 27 29 B0
2	3	020300	N-port	20 00 00 00 C9 27 29 8B	10 00 00 00 C9 27 29 8B
2	4	020400	N-port	20 00 00 00 C9 27 2A 29	10 00 00 00 C9 27 2A 29
2	6	020600	NL-port	50 08 05 F3 00 00 07 50	50 08 05 F3 00 00 07 51

Latest device information retrieved.

Cancel Clear Status Refresh

Figure 3-7: Device view window

Session Configuration

When the **Session Configuration** button is selected, the SNMP settings are provided for this session of the Management Utility application, as shown in the following figure. They can be viewed or modified from this window.

The screenshot shows a window titled "Session Configuration" with the Compaq logo in the top right corner. The window contains a section for "SNMP settings" with the following fields and values:

- Polling Rate (sec): 3
- Timeout (msec): 5000
- Retry Count: 2
- Read Community: public
- Write Community: private

Below the settings are "Apply" and "Reset" buttons. At the bottom of the window, there is a status bar with a temperature gauge, a lock icon, a text input field, and "Cancel", "Clear Status", and "Refresh" buttons.

Figure 3-8: Main session

Help

When the **Help** button is selected, the application information and service contact information is provided as well as access to the on-line help system, as shown in the following figure.

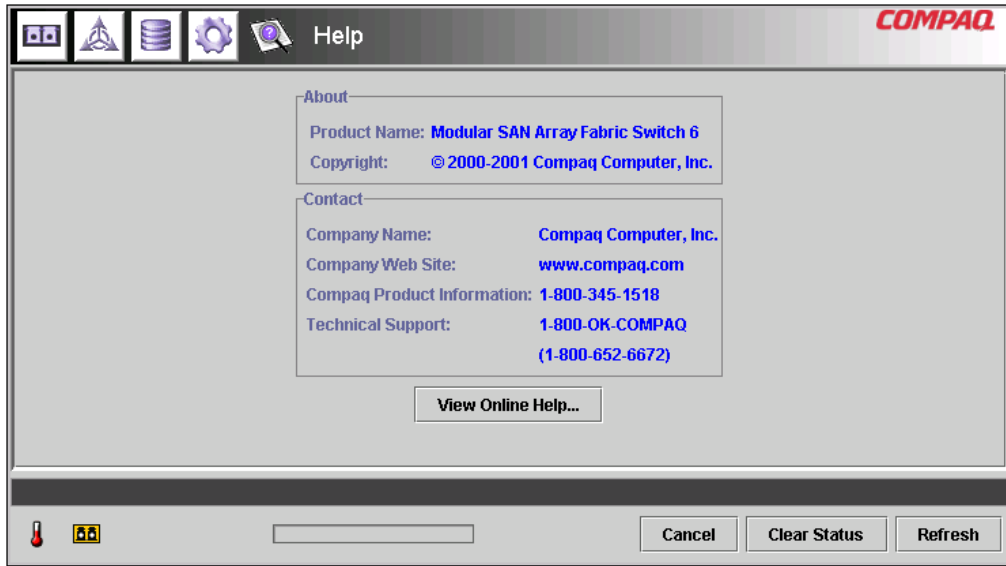

Figure 3-9: Main help session

Using MSA Fabric Switch 6 Management Utility

The Management Utility lets you manage and monitor a Fabric Switch 6 remotely through a web-browser interface. The following sections will help you to use the Management Utility:

- Managing and Monitoring individual ports
- Managing from the system information panel
- Monitoring from the Device View
- Session Configuration
- Setting up Zoning

Each of these topics is discussed in the following sections.

Managing and Monitoring Individual Ports

The Port Information task is accessed by clicking the **Port** button in the Task Selection toolbar as shown in Figure 3-10.

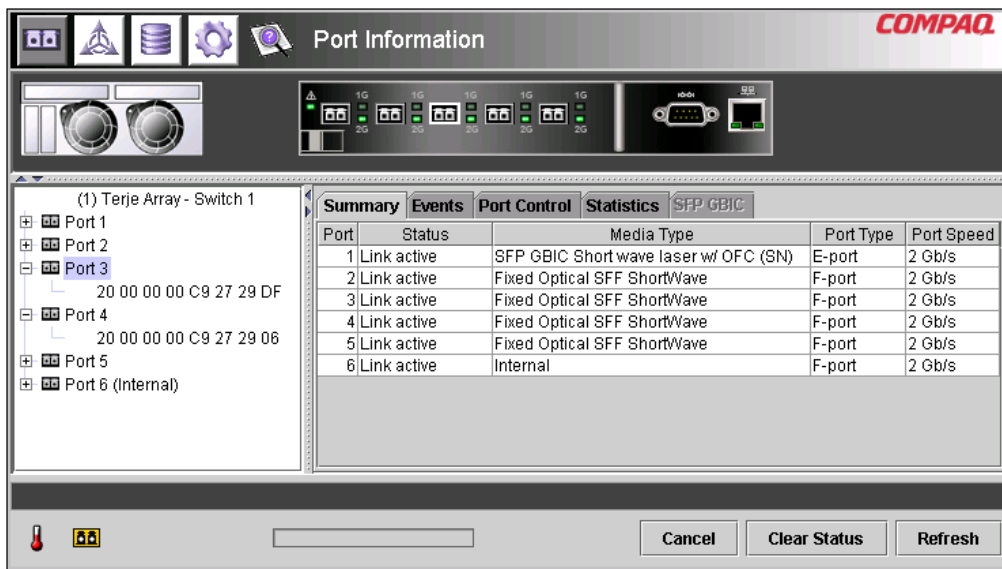

Figure 3-10: Port button in task selection toolbar

This view provides information about configuration and operation of all of the ports on the MSA Fabric Switch 6 being monitored. It also provides configuration and operation information about individual ports that are selected from either the tree representation or the switch graphic. It consists of the following five tabbed pages:

- Port Summary Tab
- Port Events Tab
- Port Control Tab
- Port Statistics Tab
- Port SFP Tab

Each of these tabs and their management functions is described in the following sections.

Port Summary Tab

The Port Summary window is the default foreground display when the **Port** button on the toolbar is clicked. It consists of a table that describes the status and configuration of each of the ports on the switch. The following figure is an example of this display.

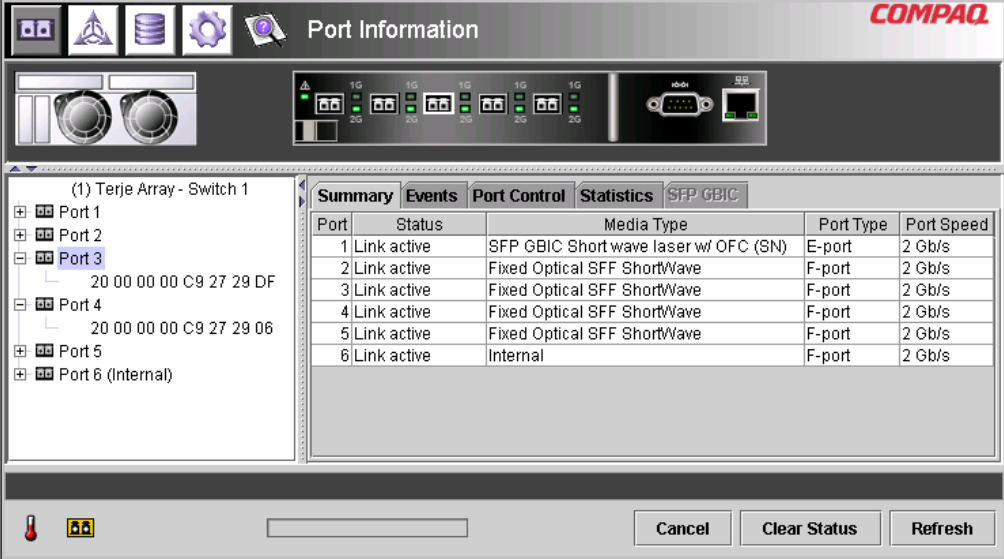

The screenshot shows the 'Port Information' window with the 'Port Summary' tab selected. The window title is 'COMPAQ Port Information'. The left pane shows a tree view for '(1) Terje Array - Switch 1' with ports 1 through 6. Port 3 is selected. The right pane shows a table with the following data:

Port	Status	Media Type	Port Type	Port Speed
1	Link active	SFP GBIC Short wave laser w/ OFC (SN)	E-port	2 Gb/s
2	Link active	Fixed Optical SFF ShortWave	F-port	2 Gb/s
3	Link active	Fixed Optical SFF ShortWave	F-port	2 Gb/s
4	Link active	Fixed Optical SFF ShortWave	F-port	2 Gb/s
5	Link active	Fixed Optical SFF ShortWave	F-port	2 Gb/s
6	Link active	Internal	F-port	2 Gb/s

Figure 3-11: Port summary tab

The Port Summary window displays current information about the port as described in the following table.

Table 3-4: Port Summary Window

Parameters	Description
Port	Identifies the port described in the row by its port number.
Status	Displays one of the following: Failed Diagnostics = could not initialize the port; the port has failed. Loopback mode = loopback cable is attached. Offline = port was taken offline by management. No media installed = no SFP installed. Link down = SFP is installed but with no link established. Link up = SFP is installed and a link to the device is established. Link active = SFP is installed, a link to the device is established, and traffic is flowing. Isolated = it is understood that the other port is an E-port but complete initialization cannot be established.
Media Type	Identifies the media type plugged into the port or that no media adapter is attached
Port Type	Displays the worldwide name for the port identified.

Port Events Tab

The Port Events window is accessed by clicking the “Events” tab of the Port Information display. It consists of a table that lists all of the ports related events generated by the MSA Fabric Switch 6 being monitored as shown in the following figure. This events table, as shown in the following figure, displays the parameters described in the following table for each event logged.

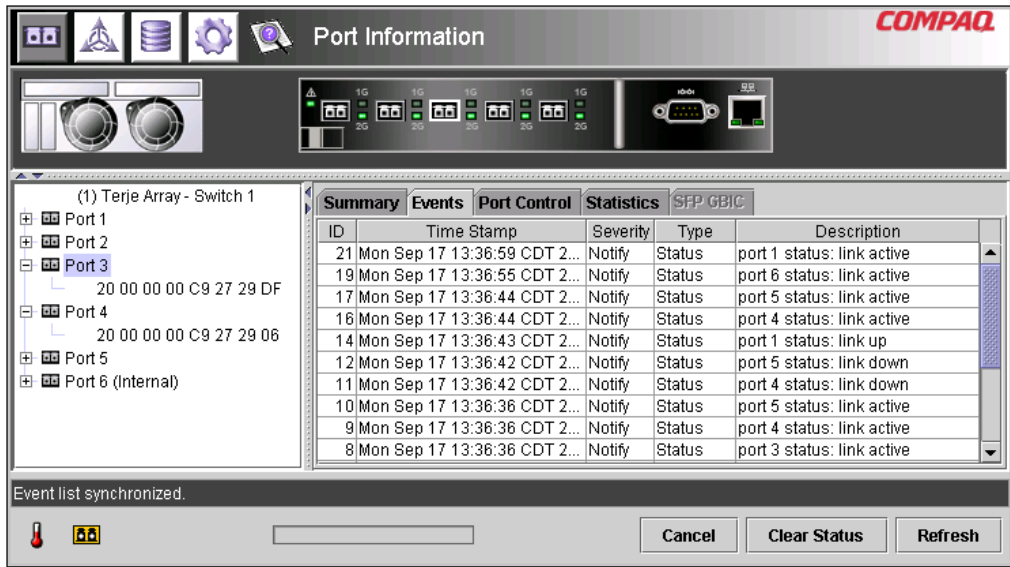

Figure 3-12: Port Events tab

Table 3-5: Port Events Window

Parameters	Description
ID	The sequential number indicating the order in which the event was sent.
Time Stamp	The time when the event was logged.

continued

Table 3-5: Port Events Window *continued*

Parameters	Description
Severity	The severity level of the event. The possible severity parameters are: Unknown, Emergency, Alert, Critical Error, Warning, Notify, Info, Debug, and Mark.
Type	The type of the event. The possible event type parameters are: Unknown, Other, Status, Configuration, Topology.
Description	The message generated by the event.

Port Control Tab

The Port Control window is accessed by clicking the “Port Control” tab of the Port Information display. The Port Control window consists of two boxes, Port Configuration and Port Reset that provide port status information and port configuration for the port selected. The figure that follows is an example of the Port Control display.

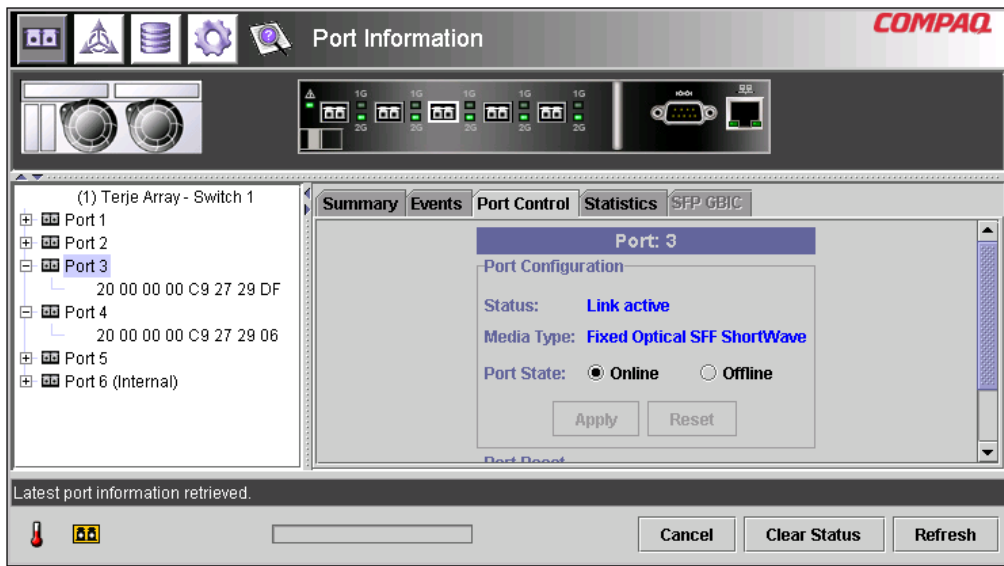
**Figure 3-13: Port info/Port Control tab**

The following figure provides an example of the Port Reset display (you must use the scroll-bar at the right side of the panel to bring the Port Reset display into view).

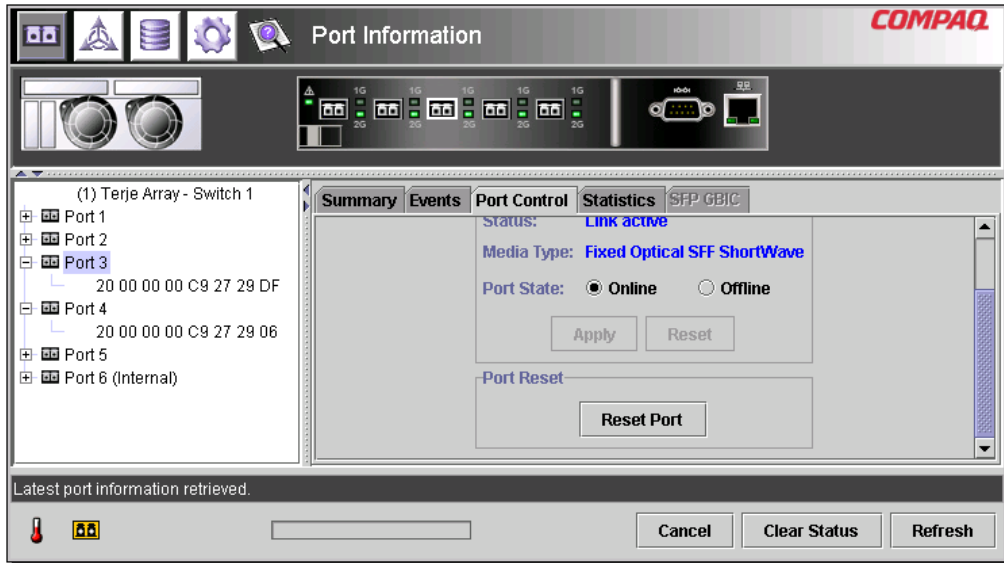

Figure 3-14: Port info/Port Reset view

The Port Control panel displays current information about the port as described in the following table.

Table 3-6: Port Control Panel

Parameters	Description
Status	Displays one of the following: Failed Diagnostics = could not initialize the port; the port has failed. Loopback mode = loopback cable is attached. Offline = port was taken offline by management. No media installed = no SFP installed. Link down = SFP is installed but with no link established. Link up = SFP is installed and a link to the device is established. Link active = SFP is installed, a link to the device is established, and traffic is flowing. Isolated = it is understood that the other port is an E-port but complete initialization cannot be established.
Media Type	Displays the media type plugged into the port or that no media interface is installed.
Detected Port Type	Indicates the current port configuration as an F-port, FL-port or E-port, or other type port.
Set Port Type	Allows you to configure the port as one of the following: F-port, FL-port, E-port, Auto
Port State	Displays and allows you to select these values: On Line = Port is enabled on the Fibre Channel network. Off Line = Port is disabled from operating on the Fibre Channel network.

continued

Table 3-6: Port Control Panel *continued*

Parameters	Description
Port Speed	<p>Displays and allows you to select these values:</p> <p>1 Gigabit = Port is set to operate at 1Gbps</p> <p>2 Gigabit = Port is set to operate at 2Gbps</p> <p>Auto = Port will determine the operating speed of the attached device (1Gbps or 2Gbps) and operate at that speed</p>
Port Cost (100-5000)	<p>Allow you to tune or manually configure routing.</p> <p>Port cost is used by routing in the shortest path calculation. Each switch-to-switch connection is assigned a 'cost' based on the shortest path calculation. The assigned path is determined by the smallest cost.</p> <p>You will only change this value if you want to tune or manually configure the routing (to force routing to select a different path). However, you may wish to modify the cost value if you know the distance on one port is much greater than on another port or if you know the port speeds are different (1Gb vs. 2Gb).</p>
Port Heartbeat (5-50)	<p>Allows you to manually adjust the number of times a heartbeat signal is missed before routing decides the switch is not longer present. Port heartbeat is used by routing to verify that a switch is still present.</p>
Port Reset	<p>Use the scroll-bar at the right side of the panel to bring this option into view. Port Reset allows you to reset the port to the previously set parameters. Click the Reset Port to return to the previous port settings.</p>

Port Statistics Tab

The Port Statistics window is accessed by clicking the “Statistics” tab in the Port Information display. It consists of the following three separate panels with statistics for the port selected:

Transmitted/Received Statistics contains the port number monitored and the number of occurrences of the parameters shown in the following table.

Table 3-7: Port Statistics tab

Parameter	Description
Transmitted Frames	The number of frames or packets transmitted out of this port.
Received Frames	The number of frames or packets received at this port.
4-byte Words Transmitted	The number of 4-byte words transmitted out of this port.
4-byte Words Received	The number of 4-byte words received at this port.
Transmitted Broadcast Frames	The number of broadcast frames or packets transmitted out of this port. For a Fibre Channel loop, this is the number of OPN _r frames generated.
Received Broadcast Frames	The number of broadcast frames or packets received at this port.
Offline Sequences	The number of times the system was unavailable for meaningful work. For example, when the system was in self-test mode, configuration, and so on.
Rx/Tx 0-64 Byte Frames	The number of frames of length between 0 - 64 bytes that passed through this port.
Rx/Tx 65-127 Byte Frames	The number of frames of length between 65 - 127 bytes that passed through this port.
Rx/Tx 128-255 Byte Frames	The number of frames of length between 128 - 255 bytes that passed through this port.

continued

Table 3-7: Port Statistics tab *continued*

Parameter	Description
Rx/Tx 256-511 Byte Frames	The number of frames of length between 256 - 511 bytes that passed through this port.
Rx/Tx 512-1023 Byte Frames	The number of frames of length between 512 - 1023 bytes that passed through this port.
Rx/Tx 1024-1518 Byte Frames	The number of frames of length between 1024 - 1518 bytes that passed through this port.
Rx/Tx 1519-2148 Byte Frames	The number of frames of length between 1519 - 2148 bytes that passed through this port.

Error Statistics contains the number of occurrences of the statistics and error parameters shown the following table. Except for Link Resets, all of the parameters listed here are a part of the link error status block. You must use the scroll down to bring this into view.

Table 3-8: Error Statistics

Parameter	Description
Link Resets	The number of link resets received at this port.
Link Failures	The number of link failures.
Loss of Synchronization	The number of instances of synchronization loss detected at this port.
Loss of Signal	The number of instances of signal loss detected at this port.
Invalid CRC	The number of invalid CRCs on the selected port. Loop ports do not count CRC errors.
Invalid Transmission Words	The number of invalid transmission words received at this port.

continued

Table 3-8: Error Statistics *continued*

Parameter	Description
Primitive Sequence Protocol Errors	The number of primitive sequence protocol errors detected at this port.
Receive Frame Length Errors	The number of frames with invalid lengths received on this port.
Receive Frame Check Sequence	The number of frames received with invalid CRCs.
Receive Dropped Frames	The number of frames that were dropped on receive.
Transmit Dropped Frames	The number of frames that were dropped on transmit.

Stat Counter Reset — Contains a button that gives you the ability to reset the statistical counters. Selecting this button will reset all the counters in the switch to zero. You must use the scroll down to bring this into view. The following figures provide an example of the Port Statistics tab, the Error Statistics View, and the Stat Counter Reset view.

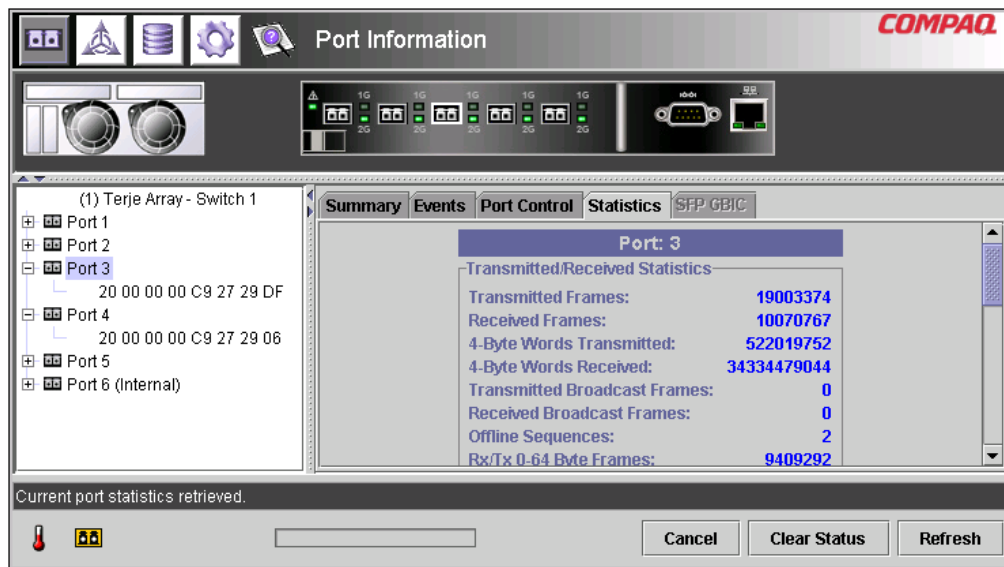
**Figure 3-15: Port statistics tab**

The screenshot shows the 'Port Information' window for a Compaq switch. The left sidebar lists ports 1 through 6, with Port 3 selected. The main pane displays the 'Error Statistics' tab, showing the following data:

Statistic	Value
Link Resets:	0
Link Failures:	0
Loss of Synchronization:	76188
Loss of Signal:	60535
Invalid CRC:	0
Invalid Transmission Words:	9
Primitive Sequence Protocol Errors:	0
Receive Frame Length Errors:	0
Receive Frame Check Sequence:	0

Buttons at the bottom include 'Cancel', 'Clear Status', and 'Refresh'. A status bar at the bottom left indicates 'Current port statistics retrieved.'

Figure 3-16: Error statistics view

The screenshot shows the 'Port Information' window for a Compaq switch. The left sidebar lists ports 1 through 6, with Port 3 selected. The main pane displays the 'Statistics' tab, showing the following data:

Statistic	Value
Invalid Transmission Words:	9
Primitive Sequence Protocol Errors:	0
Receive Frame Length Errors:	0
Receive Frame Check Sequence:	0
Receive Dropped Frames:	0
Transmit Dropped Frames:	0

Below the statistics is a 'Stat Counter Reset' section with a 'Reset Counters' button. Buttons at the bottom include 'Cancel', 'Clear Status', and 'Refresh'. A status bar at the bottom left indicates 'Current port statistics retrieved.'

Figure 3-17: Stat counter reset view

Port SFP Tab

The Port SFP window is accessed by clicking the “SFP” tab in the Port Information display. It allows you to view information about the SFP on the selected port from any of the following categories: Transmitter, Operational, Vendor, Shortwave, and Longwave.

Use the scroll-bar on the right side of the panel to view additional data. The following figures provide examples of the Transmitter display, the compliance parameter on the Transmitter display, the Operation display, the Vendor display, and the Unformatted Data parameter on the Vendor Display.

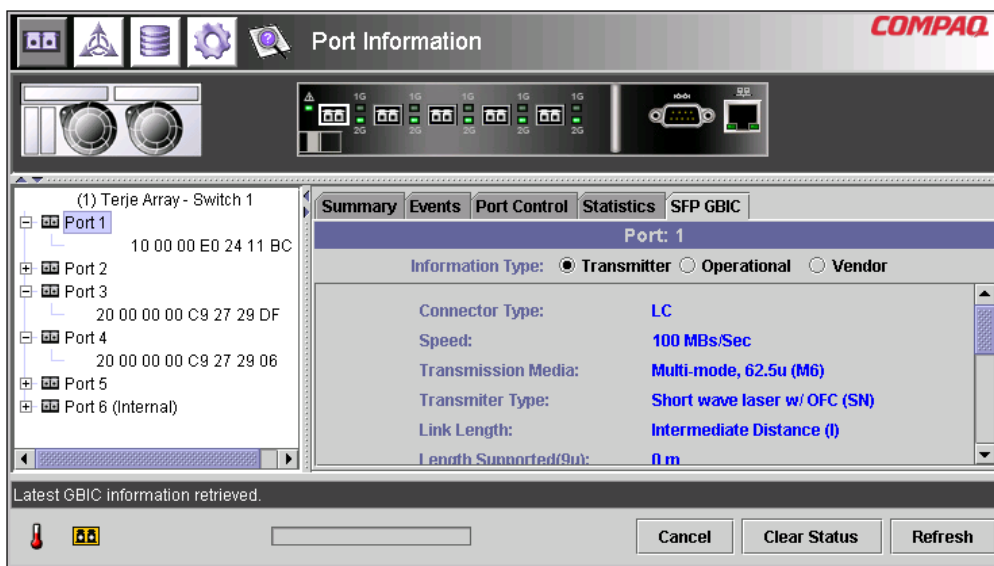

Figure 3-18: SFP tab – transmitter display

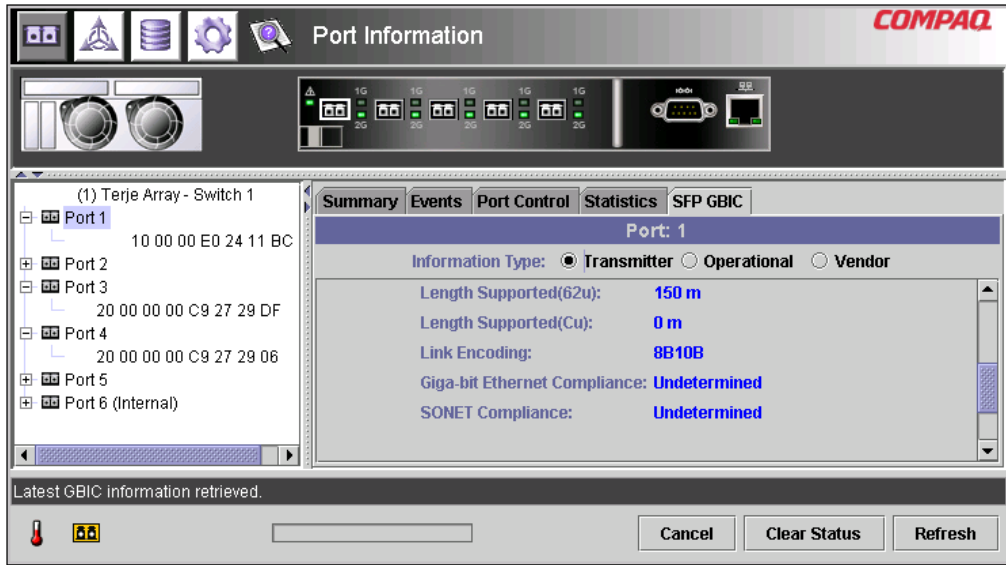

Figure 3-19: SFP tab – transmitter display, second part

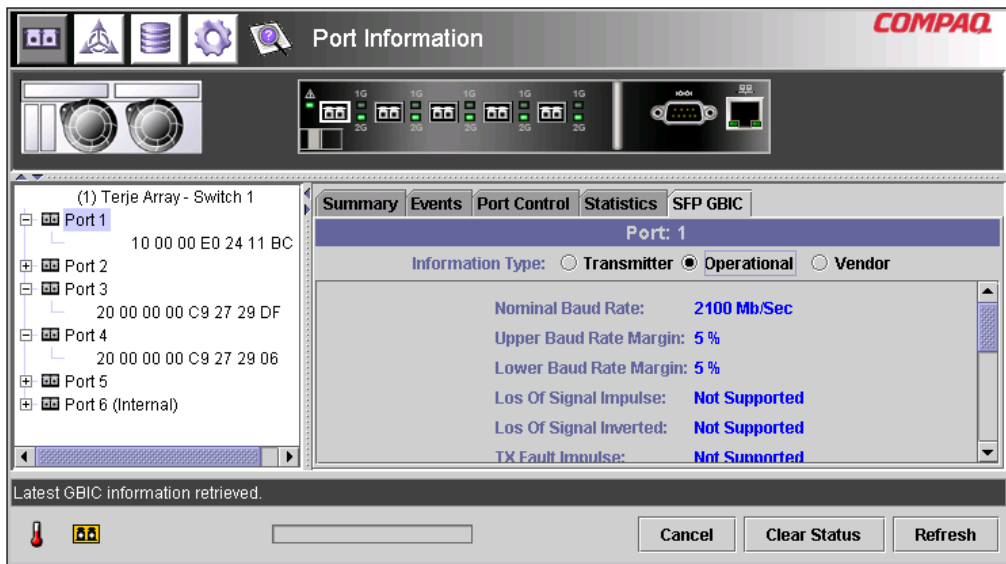

Figure 3-20: SFP tab – operational display

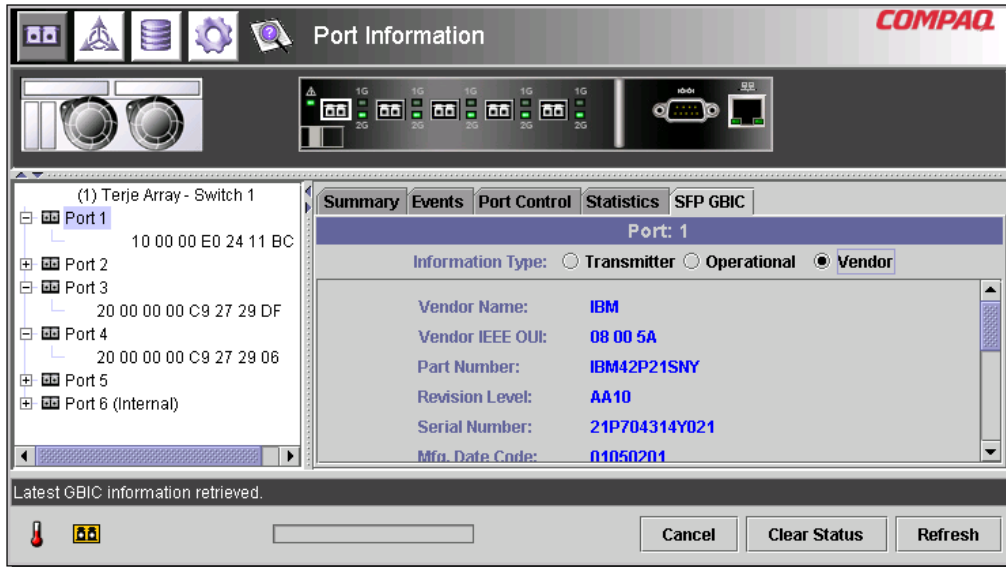

Figure 3-21: SFP tab – vendor display

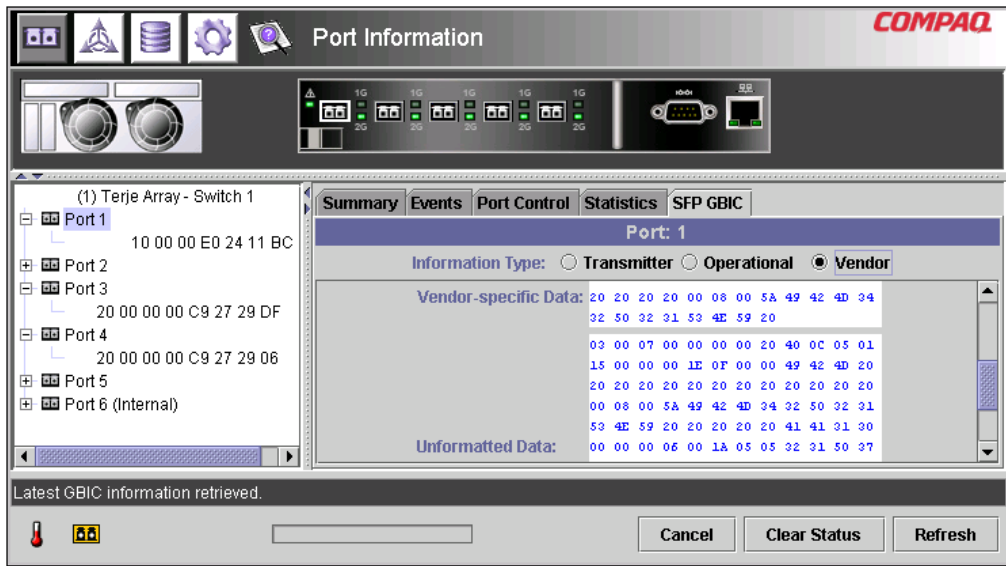

Figure 3-22: SFP tab – vendor display, second part

Managing from the System Information Panel

Selecting the **System Information** button brings up the System Information panels of the Fabric Switch 6 Management Utility display. This display allows you to perform a variety of management and monitoring functions relevant to the MSA Fabric Switch 6 you are managing, as shown in the following figure.

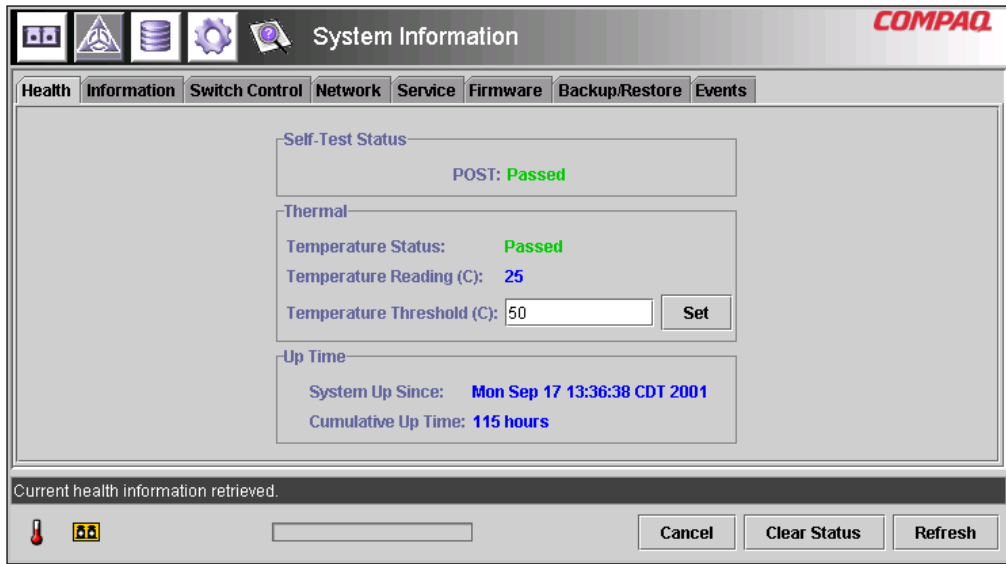

Figure 3-23: System information panel

The System Information is used to manage switch-wide parameters and consists of the following eight tabbed pages. These pages provide a variety of switch-wide, management, and monitoring functions:

- Health Tab
- Information tab
- Switch Control Tab
- Network Tab
- Service Tab
- Firmware Tab

- Backup/Restore Tab
- Events Tab

Each of these tabs and their management functions is described in the following sections.

Switch Health Tab

The Switch Health window is the default tab that is displayed when the **System Information** button is clicked for the first time. It can also be displayed by clicking the “Health” tab. It consists of the following three separate boxes that provide operating information about the switch being managed:

- Self-Test Status
- Thermal
- Up Time

The following figure provides an example of this display.

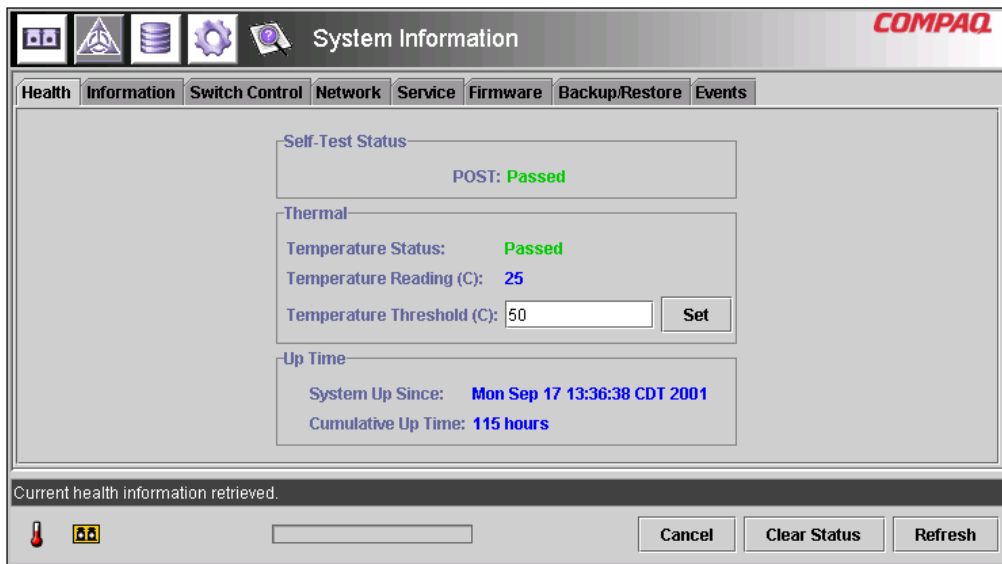

Figure 3-24: Switch health tab

The following table lists each of the parameters in this display.

Table 3-9: Switch health window

Panel	Parameter	Description
Self-Test Status	POST	Provides status of either Passed or Failed for the Power On Self Test.
Thermal	Temperature Status	Status is presented as Passed if the internal temperature of the chassis is below the threshold temperature that is currently set or Failed if it is above. The operating temperature of the switch must be kept between 10 and 40 degrees Celsius (between 50 and 104 degrees Fahrenheit).
	Temperature Reading	Current internal temperature of the chassis.
	Temperature Threshold	The current threshold temperature for the switch is presented in a text box. This threshold temperature can be changed by entering a new variable and clicking the Set button within the "Thermal" panel.
Up Time	System Up Since	The exact time that the system was last powered-up.
	Cumulative Up Time	The amount of time in hours that the switch has been running since manufacture.

Information Tab

The Information window is accessed by clicking the “Information” tab of the System Information display. It consists of two separate panels that provide identification and firmware version information about the switch being managed. The following figure is an example of this display.

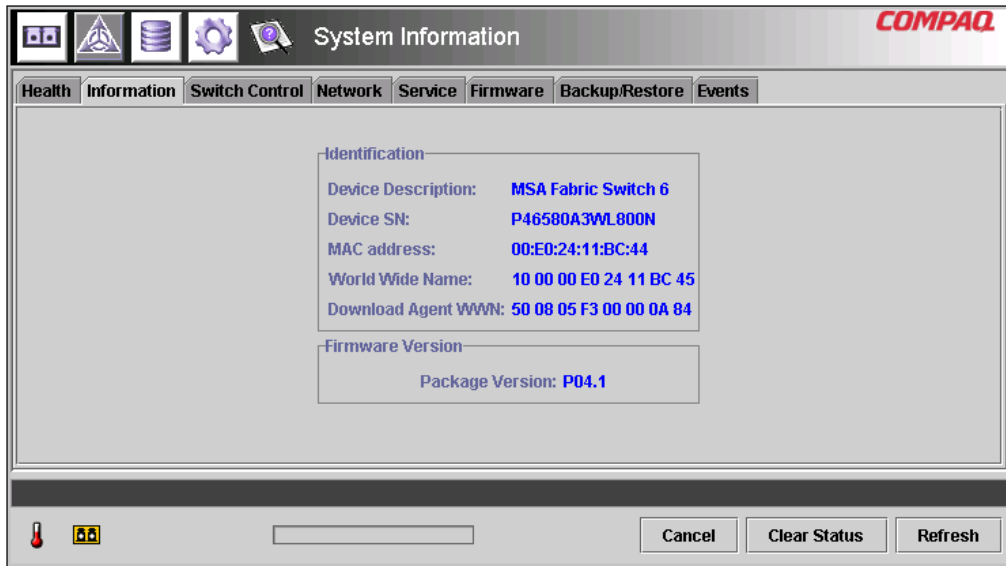

Figure 3-25: Switch info tab

The following table lists each of the parameters in this display.

Table 3-10: Switch Info Window

Panel	Parameter	Description
Identification	Device Description	Product Name of the MSA Fabric Switch 6 that is being managed.
	Device SN	Serial number of the switch being managed.
	MAC address	MAC address of the switch being managed.
	World Wide Name	World Wide Name of the switch being managed.
Firmware Version	Fabric Switch 6 Version	Firmware revision number of the firmware base package within the switch being managed.

Switch Control Tab

The Switch Control window is accessed by clicking the “Switch Control” tab of the System Information display. It consists of three panels: “Switch Configuration,” “Switch Reset,” and “Restore Factory Defaults” as shown in the following figure.

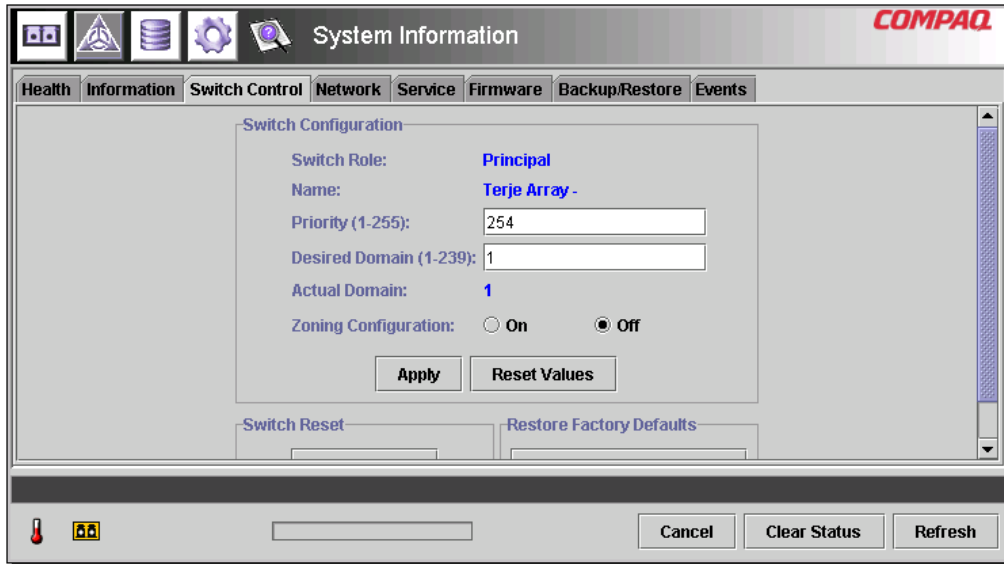

Figure 3-26: Switch control tab

The following table lists each of the parameters in this display. The parameters in this configuration are set by typing the new value into a text box or selecting a radio button and clicking the **Apply** button in the Switch Configuration box. The **Reset Values** button in the Switch Configuration box returns the parameters to their previous settings.

Table 3-11: Switch Control Window

Parameter	Description
Switch Role	Displays whether switch is configured as the Principal switch or a Subordinate switch in the Fabric.
Name	Displays the system-generated switch name: <ul style="list-style-type: none"> Switch installed in slot 1: <i>MSA1000 name-switch1</i> Switch installed in slot 2: <i>MSA1000 name-switch2</i>
Priority (1-255)	This parameter allows you to determine the priority that this switch will have compared to other devices if it requests Fabric resources at the same time as other devices. The variable is used during the SW-2 principal switch selection process. Any number between 1 and 255 can be used for this setting. A lower number results in a higher priority for the switch. The switch with the lowest priority number will become the principal switch. If two switches have the same "lowest priority number", then the switch with the lowest WWN number will become the principal switch. A priority 1 forces the switch to be principal; a priority 255 will never allow the switch to be principal switch. Priority 2 is reserved for the current elected principal switch. The principal switch will change its priority to 2 if its priority is greater than 2.
Desired Domain (1-239)	Any number between 1 and 239. For inter operability, each switch in a Fabric must have a different domain number. You can specify the desired domain. However, the actual domain that is set may be different (for example, if the domain is already in use). This domain number is used during SW-2 principal switch selection.
Actual Domain	Displays the current domain.
Address Translation	Address translation allows you to address devices with private addresses through the Fabric. The port must be private for this to function. Choose the correct radio button to turn address translation on or off. This is limited to private targets.

continued

Table 3-11: Switch Control Window *continued*

Parameter	Description
Send Fabric Address Notification	<p>Fabric Address Notification (FAN) frames are sent by the Fabric to notify public loop devices about their node ID and address. The default setting is No.</p> <p>Choosing Yes configures the switch to send Fabric Address Notification frames.</p> <p>Choosing No configures the switch to not send Fabric Address Notification frames.</p>
Force IOD State	<p>Allows you to determine whether delivery of frames is completed in-order or out-of-order. Out-of-order delivery can happen when a trunk failure occurs in the fabric and traffic is rerouted around the failure.</p> <p>Choosing On enables Forced In Order delivery when the fabric topology is changed. Use with care as enabling this feature will cause a delay when a trunk failure occurs.</p> <p>Choosing Off disables Force In Order delivery and allows out-of-order delivery. Note that some legacy devices cannot handle out-of-order delivery and will require that this feature be enabled on all switches.</p>
Forced IOD Delay (1-60 sec.)	<p>This is the delay time for Force In Order Delivery (if enabled). It specifies the delay time before rerouting traffic to an alternative trunk. The minimum delay time is 1 second; the maximum delay is 60 seconds. Set this parameter to greater than the E_D_TOV time of the legacy device that requires in order delivery.</p>
Reset Switch	<p>This allows you to reset the switch. Use with caution as this will disrupt switch operations.</p>
Restore Factory Defaults	<p>Restores the settings enabled at the factory.</p>

Network Tab

The Network window is accessed by clicking the “Network” tab of the System Information display. It consists of the following two panels:

- IP Configuration
- SNMP Trap Management Stations

NOTE: The System Information - Network Tab page will not function properly without a valid gateway address. If you are using the default gateway address (0.0.0.0) or an invalid gateway address, you will need to change the address to a valid one. To check the gateway address on your system using the CLI, see the section titled “NetCfg”. To change the gateway address using the CLI, see the section titled “Setting the Gateway Address.”

IP Configuration This panel, as shown in the following figure, displays all of the IP networking parameters that were set on the Fabric Switch 6 using the serial interface.

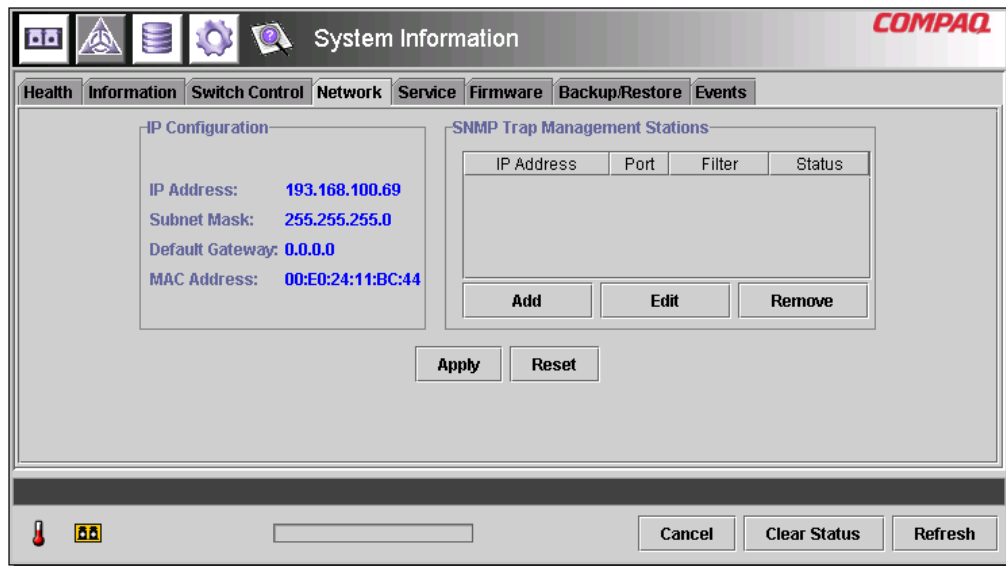

Figure 3-27: Network tab

The following table lists the parameters of this panel.

Table 3-12: Network tab

Parameter	Description
IP Address	Displays the IP address assigned to the MSA Fabric Switch 6.
Subnet Mask	Displays the subnet mask assigned to the MSA Fabric Switch 6.
Default Gateway	Displays the default gateway assigned to the MSA Fabric Switch 6.
MAC Address	Displays the MAC address of the MSA Fabric Switch 6.

SNMP Trap Management Stations— This panel, as shown above in Figure 3-27, allows you to add and remove stations that have SNMP traps forwarded to them.

- To add a station, type its IP address and Port Number in the top text boxes in this panel and click the **Add** button.
- To remove a station from receiving traps from this Fabric Switch 6, highlight its IP address in the list box at the bottom of this panel and click the **Remove** button.
- To apply the changes, click the **Apply** button. To undo all the changes and reset the display to the original settings, click the **Reset** button.

NOTE: The port number entered should be a valid port address. Most systems support a range of 1-65534.

Service Tab

The Service window is accessed by clicking the “Service” tab of the System Information display. It consists of the “Location and Contact Information” panel as shown in the following figure.

The screenshot shows the 'Service' tab of the 'System Information' window. The 'Location and Contact Information' panel is active, displaying the following fields:

- System Name : Terje Array - Switch 1
- Device Location :
- Contact Name :
- Contact Email :
- Contact Phone :

Buttons for 'Apply' and 'Reset' are located below the form. The bottom of the window features a status bar with a temperature gauge, a warning icon, a progress bar, and buttons for 'Cancel', 'Clear Status', and 'Refresh'.

Figure 3-28: Service tab

This window allows you to read the location and contact information that is currently configured for the switch and to modify it by selecting it and editing.

All the information in this panel is for informational purposes only. The switch does not use any of this information to perform functions. For example, the switch will not send out emails to the email address listed. However, some management applications, including future versions, may display some of the information listed on the Service tab page.

Firmware Tab

The Firmware window is accessed by clicking the “Firmware” tab of the System Information display. This window, as shown in the figure below, allows you to download new firmware to your MSA Fabric Switch 6. To perform a download using this interface, fill in the text boxes, click the appropriate radio button, and click the **Start Download** button.

The screenshot displays the 'Firmware' tab within the 'System Information' window of the Compaq MSA Fabric Switch 6 Management Utility. The window features a navigation bar with tabs for Health, Information, Switch Control, Network, Service, Firmware, Backup/Restore, and Events. The 'Firmware' tab is active, showing a 'Download Control' section with the following fields and values:

- Current Version : P04.1
- File Name : C8100P04.1.bin
- TFTP Server IP Address : 193.168.100.119
- TFTP Timeout (msec) : 5000
- TFTP Retries : 6
- Last Download Status : Success

Below these fields are two radio buttons: Download Only and Download & Reboot. A 'Start Download' button is positioned at the bottom of the form. The status bar at the bottom of the window includes a temperature gauge, a warning icon, a progress bar, and buttons for 'Cancel', 'Clear Status', and 'Refresh'.

Figure 3-29: Firmware tab

The following table lists the parameters in the “Download Control” panel.

Table 3-13: Firmware Window

Parameter	Description
Current Version	Displays the version of the firmware currently on the Fabric switch 6.
File Name	Enter the file name of the file that you want to download.
TFTP Server IP Address	Enter the IP address of the TFTP Server from which you want to download the new firmware.
TFTP Time-out (msec)	Enter the time in milliseconds that you want the switch to wait after requesting a download before requesting again.
TFTP Retries	Enter the number of times you want the switch to try downloading the new firmware before quitting.
Last Download Status	This parameter reports either success or failure for the last download operation.
Download Only	Click this radio button if you want the switch to download the new firmware without rebooting. You must reboot the switch for the new firmware to become operable.
Download & Reboot	Click this radio button if you want the switch to download the new firmware and then reboot the switch. The new firmware becomes operable when the switch is rebooted. You will need to reload the Applet after the switch is rebooted. Note: Resetting the switch disrupts the network. This may affect performance, but does not corrupt the data on the disk drives attached to the switch. It does, however, erase any statistics and other management data that has been collected.

Backup/Restore Tab

The Backup/Restore window is accessed by clicking the “Backup/Restore” tab of the System Information display. It consists of one panel titled: “Backup and Restore Settings.” Using this interface, you can save the current configuration parameters of the switch to a named TFTP server. You can also restore any previously saved configuration to the switch.

To perform either a backup or restore operation, enter the correct parameters for “Backup/Restore File Set” and “TFTP Server IP Address” and click either the **Backup** or **Restore** button.



CAUTION: TFTP servers will create new files with modified filenames, resulting in ‘restore’ not retrieving the expected file. Be sure to verify that the TFTP server you are using overwrites existing files to avoid this issue.

The following figure is an example of the Backup/Restore tab.

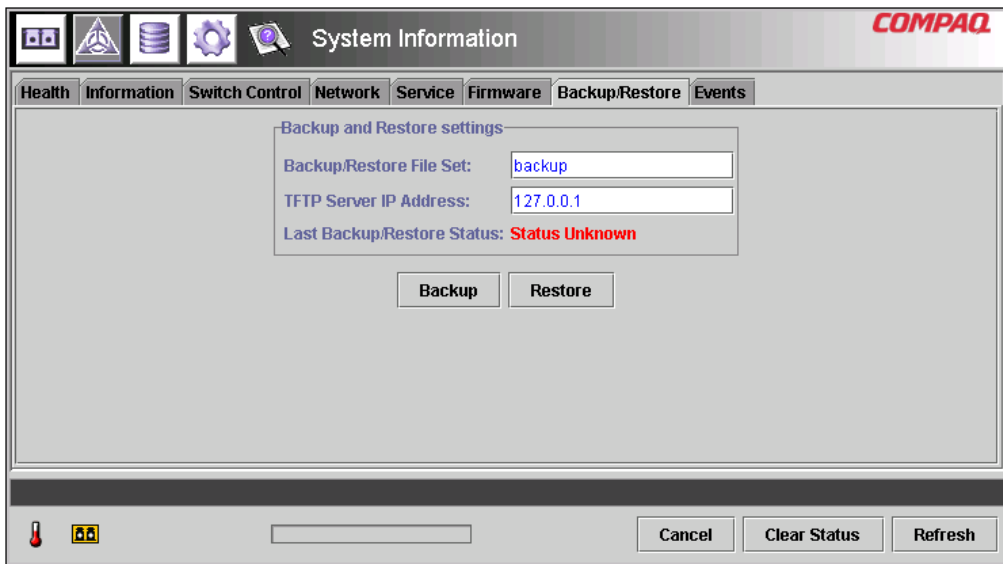

Figure 3-30: Backup/Restore tab

The following table lists each of the parameters in this display.

Table 3-14: Backup/Restore tab

Parameters	Description
Backup/Restore File Set	The name for the set of files that contains the backup configuration.
TFTP Server IP Address	The IP address of the TFTP server that you want to save a configuration file to or restore a configuration file from.
Last Backup/Restore Status	Displays the status of the last backup/restore action performed on the switch. The status will be "Status Unknown" if there has not been a Backup/Restore action since the last time the switch was started.

Events Tab

The Events window is accessed by clicking the “Events” tab of the System Information display. It consists of a table that lists all of the events generated by the switch being monitored as shown in the following figure. Also included on this page are two list-filtering options, System Events and Port Events.

System Information

Health Information Switch Control Network Service Firmware Backup/Restore Events

Show: System Events Port Events

ID	Time Stamp	Severity	Type	Description
25	Mon Sep 17 14:25:18 CDT 2001	Notify	Topology	name server table has changed
24	Mon Sep 17 14:23:37 CDT 2001	Notify	Topology	name server table has changed
23	Mon Sep 17 13:37:00 CDT 2001	Notify	Topology	name server table has changed
22	Mon Sep 17 13:36:59 CDT 2001	Notify	Topology	route configuration has changed
21	Mon Sep 17 13:36:59 CDT 2001	Notify	Status	port 1 status: link active
20	Mon Sep 17 13:36:56 CDT 2001	Notify	Topology	name server table has changed
19	Mon Sep 17 13:36:55 CDT 2001	Notify	Status	port 6 status: link active
18	Mon Sep 17 13:36:54 CDT 2001	Notify	Topology	name server table has changed
17	Mon Sep 17 13:36:44 CDT 2001	Notify	Status	port 5 status: link active
16	Mon Sep 17 13:36:44 CDT 2001	Notify	Status	port 4 status: link active
15	Mon Sep 17 13:36:43 CDT 2001	Notify	Topology	name server table has changed
14	Mon Sep 17 13:36:43 CDT 2001	Notify	Status	port 1 status: link up
13	Mon Sep 17 13:36:42 CDT 2001	Notify	Topology	name server table has changed

Event list synchronized.

Cancel Clear Status Refresh

Figure 3-31: Events tab

This Event log, as shown in the above figure, displays the parameters described in the table below for each event logged.

Table 3-15: Events Window

Parameter	Description
Show: System Events	Selecting System Events will filter the list so that only the events related to the system (and not the individual ports) will be listed. Selecting both System Events and Port Events will display all the events.
Show: Port Events	Selecting Port Events will filter the list so that only the events related to the ports (and not the entire system) will be listed. Selecting both System Events and Port Events will display all the events.
ID	The sequential number indicating the order in which the event was sent.
Time Stamp	The time when the event was logged.
Severity	The severity level of the event. The possible severity parameters are: Unknown, Emergency, Alert, Critical, Error, Warning, Notify, Info, Debug, Mark.
Type	The type of the event. The possible event type parameters are: Unknown, Other, Status, Configuration, Topology.
Description	A description of the event.

Monitoring from the Device View

Selecting the **Device View** button brings up Device View display. This display allows you to monitor devices connected to the switch, as shown in the following figure.

Domain	Port	Port ID	Port Type	Node WWN	Port WWN
1	2	010200	N-port	20 00 00 00 C9 27 29 C6	10 00 00 00 C9 27 29 C6
1	3	010300	N-port	20 00 00 00 C9 27 29 DF	10 00 00 00 C9 27 29 DF
1	4	010400	N-port	20 00 00 00 C9 27 29 06	10 00 00 00 C9 27 29 06
1	5	010500	N-port	20 00 00 00 C9 27 29 C5	10 00 00 00 C9 27 29 C5
1	6	010600	NL-port	50 08 05 F3 00 00 0A 80	50 08 05 F3 00 00 0A 81
2	1	020100	N-port	20 00 00 00 C9 27 25 B9	10 00 00 00 C9 27 25 B9
2	2	020200	N-port	20 00 00 00 C9 27 29 B0	10 00 00 00 C9 27 29 B0
2	3	020300	N-port	20 00 00 00 C9 27 29 8B	10 00 00 00 C9 27 29 8B
2	4	020400	N-port	20 00 00 00 C9 27 2A 29	10 00 00 00 C9 27 2A 29
2	6	020600	NL-port	50 08 05 F3 00 00 07 50	50 08 05 F3 00 00 07 51

Figure 3-32: Device view

Depending on the icon selected in the tree, the Device View provides the following information about the switch, the ports, or the devices connected to the switch. Selecting members from the tree acts like a list filter. Selecting the switch in the tree will list information about all the devices connected to the switch. Selecting a port in the tree will list information about the selected port only. Selecting a device in the tree will list information about the selected device only.

- **Port** — The port number on the switch.
- **Node Type** — The type of device connected to the port. For example, Storage Device, or Raid Array. In cases where it is not possible to determine the device type, it will be listed as “unknown.”
- **Remote Port Type** — The type of port on the attached device.

- **WWN** — The World Wide Name of the device connected to the port.
- **WWPN** — The World Wide Port Name of the device connected to the port.

Session Configuration

Selecting the Session Configuration button allows you to view the current SNMP settings used by the Fabric Switch 6 and change them by typing new values in the text boxes.

- To change a value, type the new values in the text boxes and click **Apply**.
- To return the settings to their previous values, click **Reset**.

NOTE: If the community strings specified do not match what is configured in the switch, the application will not be able to communicate with the switch.

The parameters for Session Configuration are described in the following table.

Table 3-16: Session Configuration Window

Parameter	Description
Polling Rate	This setting allows you to specify the rate for detecting the changes of devices in the network or changes in the device environment status. Valid values are 1-3600(sec).
Timeout	<p>When the Fabric Management Utility issues a request to a managed device, if the device fails to respond, it waits for a specified number of milliseconds and then retries its request. This parameter sets the amount of time that the switch utility waits before it retries its request. Valid values are 500-5000 (ms).</p> <p>The timeout for each retry is increased exponentially. For example, if the timeout value is set to 5000 ms and retry is set to 2:</p> <ul style="list-style-type: none"> • The initial attempt will time out in 5000 ms. • The first retry will time out in 10000 ms. • The second retry will time out in 20000 ms. <p>Compaq recommends that you set the retry count low if the timeout value is high.</p>

continued

Table 3-16: Session Configuration Window *continued*

Parameter	Description
Retry Count	The number of times that Management Utility will issue requests to the managed device before reporting a loss of connection. Valid values 0-4.
Read Community	SNMP Read Community string is the password required to read management data from the switch. This value must match the setting for the switch that you are managing as it was set using the Command Line Interface (CLI). If the values do not match, the application will not be able to retrieve information from the switch.
Write Community	SNMP Write Community string is the password required to write management data to the switch. This value must match the setting for the switch that you are managing as it was set using the Command Line Interface (CLI). If the values do not match, the utility will not be able to modify any values in the switch. If the community strings specified do not match what is configured in the switch, the application will not be able to communicate with the switch.

NOTE: If the display properties on your computer system are set to “256 colors,” the Community Strings window will appear patterned and unclear. Change your display properties setting to either “True Color (32 bit)” or “High Color (16 bit)” for a sharp, clear image. You will find the display properties setting under Start\Settings\Control Panel\Display\Settings or right-click your desktop and select Active Desktop\Customize\Settings.

Setting up Zoning

Zoning is a function of the MSA Fabric Switch 6 that allows you to create isolated Fibre Channel networks with a limited number of connected devices. By limiting the number of devices in a zone, you can obtain more robust performance and enhance access protection.

Zoning is compliant with the following standards:

- FC-SW-2
- FC-GS3
- FC-MI

This section describes the zoning functions supported by the MSA Fabric Switch 6. It describes zoning at the individual switch and describes how the merge command functions are used to support zoning across a Fabric.

Zoning Elements

Before setting up zoning, you must understand the following zoning elements:

- Zone Members
- Zones
- Zone Sets



CAUTION: Never add a zoned switch to an established fabric that has no zoning. If a switch configured with zoning is added to a fabric that has no configured zoning, the fabric's HBAs and targets will no longer be able to communicate and the traffic in the fabric will be disrupted. For best results, only add a switch configured with zoning to a fabric configured with the same zoning configuration.

Zone Members

Zone members are Fibre Channel edge devices that are identified by their World Wide Port Name (WWPN). Any device that you want to include in a zone must be identified as a zone member. While internally the zone members are tracked by their WWPN, you can create a Zone Member Name that acts as an alias for the device. This makes it easier to identify the devices during configuration and operation. The following are examples of Fibre Channel devices that can be named as zone members:

- Servers
- Raid systems
- Disk drives
- Tape libraries

IMPORTANT: The World Wide Node Name (WWNN) of the Fibre Channel device cannot be used to create a zone member. WWNN-based zoning is expressly prohibited in the FC-MI standard. Use World Wide Port Name (WWPN) to create a zone member.

Zones

Zones are logical entities that represent groupings of zone members. Each zone must be assigned a unique zone name when it is defined.

Zone Sets

Zone sets are logical entities that represent groupings of zones. They define a zoning configuration. Each zone set is assigned a unique zone set name when it is defined. The MSA Fabric Switch 6 allows storing of multiple zone sets. However, only one of these zone sets can be active at a time. The other zone sets can be used as backup, trials, or other user-defined configurations.

Naming Rules for Zone Members, Zones, and Zone Sets

Zone member, zone, and zone set names must follow these rules:

- Names must be between 1 and 64 characters long
- Characters used in names must be 7 bit ASCII characters
- The first character of a name must be a letter (a-z) and can be either upper case or lower case
- Other characters of the name (any characters besides the first character) can be a letter (a-z, either upper or lower case), a number (0-9), or a symbol (\$ - ^ _).
- No spaces are allowed in the name

Zoning Limitations for Zone Members, Zones, and Zone Sets

There are zoning limitations for individual switches and fabrics. See Table 3-17 for maximum limitations.

Table 3-17: Switch and Fabric Zoning Limitations

Item	Maximum
Number of Zone Sets	4
Number of Zones	64
Number of Zone Members	64

Two Ways to Display Zoning

The MSA Fabric Switch 6 Management Utility allows you to display zoning in two ways:

- Merged zones
- Local zones

To toggle between the Merged Zones display and the Local Zones display, expand the **Zoning View** drop-down list in the Zoning Configuration screen.

Merged Zones

Use the Merged Zones display when you are interested in viewing information for zones merged with other switches on the Fabric.

This view is read-only and cannot be edited. The Merged Zones view is a Fabric-wide display showing the merged zones with other switches on the fabric.

NOTE: Because only one Zone Set can be active across the entire Fabric, only the Active Zone Set is shown.

Local Zones

Use the Local Zones display when you are interested in viewing, creating, or editing zone sets, zones, and zone members for the switch presently being monitored.

This view is a read/write single-switch display showing the zone sets, zones, and zone members for that switch. You can create, edit and remove zone sets, zones, and zone members using the Local Zones view.

Using the Fabric Switch 6 Management Utility to Configure Zoning

This section describes how to use the MSA Fabric Switch 6 Management Utility to configure Zone Members, Zones, and Zone Sets and how to apply the new or edited zone configurations to the switch.

Setting up Zoning includes:

- Enabling Zoning
- Creating Zone Sets
- Creating Zones
- Creating Zone Members
- Assigning Zone Members to Zones
- Assigning Zones to Zone Sets
- Activating the Zone Set

Each of these procedures is discussed in the following paragraphs.

Enabling Zoning

IMPORTANT: The Zoning icon and its options are not displayed or accessible until Zoning is enabled.

To enable zoning:

1. In the **Switch Control** tab of the System Information screen, select the **Zoning Configuration On** radio button.

Figure 3-33 is an illustration of the **Zoning Configuration** option in the **Switch Control** tab.

2. Click **Apply** to accept the change.

The Zoning icon is now displayed next to the other icons at the top of the screen.

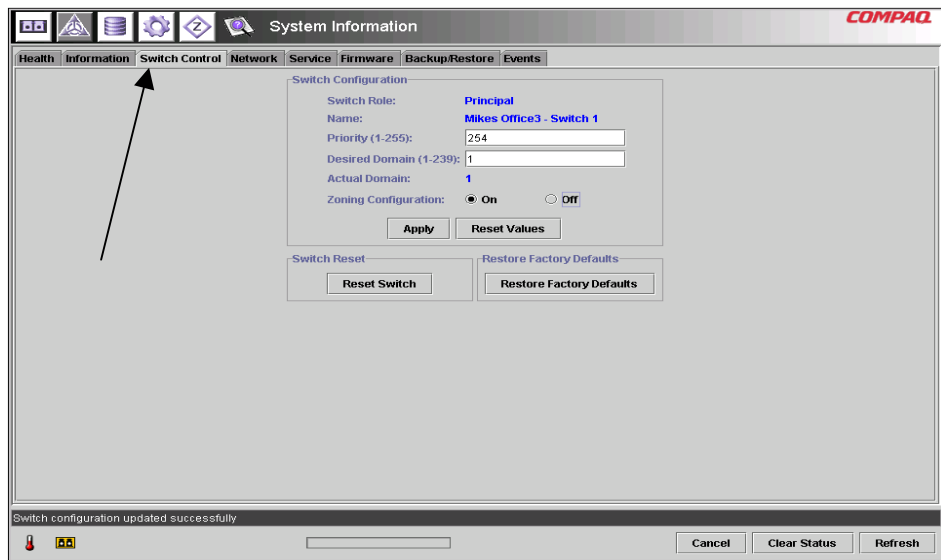

Figure 3-33: Zoning Configuration option, Switch Control tab

Creating Zone Sets

To create a Zone Set:

1. Select the Zoning icon.

The Zoning Configuration screen is displayed. Figure 3-34 is an illustration of the Zoning Configuration screen.

IMPORTANT: To create or edit Zone Sets, Zones, and Zone Members, the **Local Zones** view must be displayed. To change the view in the Zoning Configuration screen, expand the Zoning View drop-down box near the top-center of the screen.

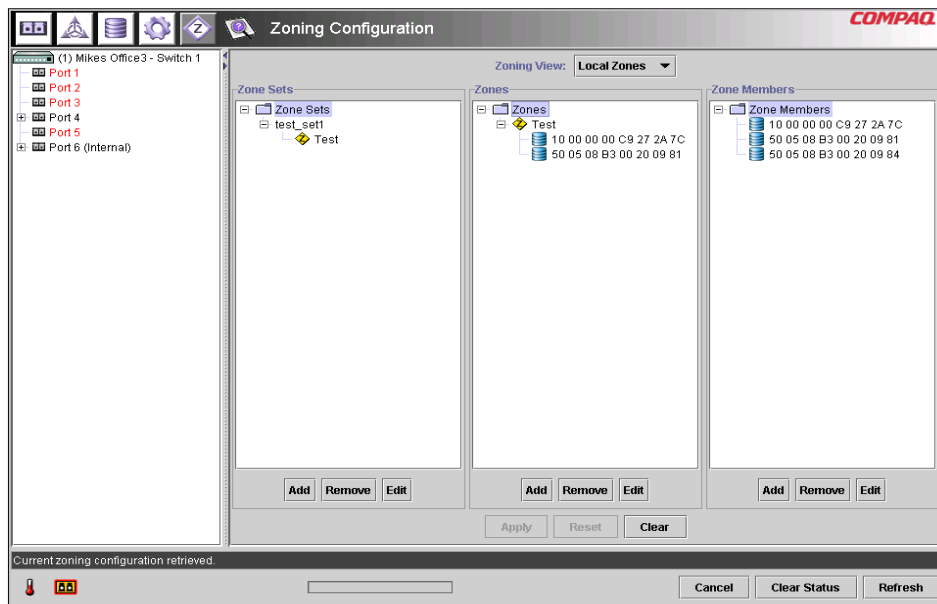

Figure 3-34: Zoning Configuration screen, Local Zones view

2. To create a new Zone Set:
 - a. In the **Zone Sets** column of the Zoning Configuration screen, click **Add**.
 - b. Enter the name for the Zone Set.
 - c. Click **OK**.
3. To create a new Zone Set by modifying an existing Zone Set:
 - a. In the **Zone Sets** column of the Zoning Configuration screen, select the existing Zone Set and click **Edit**.
 - b. In the Edit window, change the name of the Zone Set to the new name.
 - c. Click **OK**.

Creating Zones

To create new Zones:

1. In the **Zones** column of the Zoning Configuration screen, click **Add**.
2. Enter the name for the Zone.
3. Click **OK**.

Creating Zone Members

To enter the devices:

1. In the **Zone Members** column of the Zoning Configuration screen, click **Add**.
2. Enter the name of the zone member
3. Select the WWPN from the port number list.
4. Enter the WWPN name, or if the device is already connected to the switch, select the name from the dropdown menu.
5. Click **OK**.
6. Repeat these steps for each additional Zone Member.

Assigning Zone Members to Zones

To add the Zone Members to the desired Zones, select the desired Zone Member and use the drag-and-drop technique to add it to the desired Zone.

Assigning Zones to Zone Sets

To add the Zones to the desired Zone Set, select the desired Zone and use the drag-and-drop technique to add it to the desired Zone Set.

Activating the Zone Set

To activate and apply the Zone Set:

1. Right-click the desired Zone Set and select **Activate**.

The active Zone Set is shown in bold on the screen.

2. Click **Apply**.

The selected Zone Set is now the active Zone Set used by the switch.

Example Zoning Configuration

Assume the following:

- Server1 needs to access Disk1 exclusively for Operating System boot (OS Boot).
- Server1 needs to access Raid1 for shared storage.
- Server1 needs to access Tape1 for backup.
- Server2 needs to access Disk2 exclusively for Operating System boot.
- Server2 needs to access Raid1 for shared storage.
- Server2 needs to access Tape1 for backup.

Before you begin to configure your zoning, you must first define the zone members, zones, and zone sets that you will need.

Table 3 lists the zone members, zones, and zone sets being used in this example and indicates what members the zones and the zone sets contain.

Table 3-18: Example Zone Members, Zones, and Zone Set

Zone Members	Zones	Zone Set
Server1 WWPN: 1000000102421303	Web_Zone	MIS_NT_CLSTR1_SAN1
Disk 1 WWPN: 2100005004d02f78	Web_Zone	
Tape1 WWPN: 210000010241ff73	Web_Zone and Mail_Zone	
Raid1 WWPN: 210000010249a7ab	Web_Zone and Mail_Zone	
Server2 WWPN: 100000a0c99ae47a	Mail_Zone	
Disk2 WWPN: 200000600819ae48	Mail_Zone	

In this example, the Zone Set MIS_NT-CLSTR1_SAN1 contains two zones:

- Web_Zone contains the following Zone Members: Server1, Disk1, Raid1, and Tape1.
- Mail_Zone contains the following Zone Members: Server2, Disk2, Raid1, and Tape1

Troubleshooting

This chapter covers the following information about your new MSA Fabric Switch 6.

- Troubleshooting guidelines
- Troubleshooting the MSA Fabric Switch 6 with the status indicator and Reset Button
- Preventive Maintenance Solutions

Troubleshooting Guidelines

If there is a problem accessing a device connected to the switch, the source of the problem can be the MSA Fabric Switch 6 or any of the connections between the host and device. Use this chapter to troubleshoot the MSA Fabric Switch 6.

Troubleshooting the MSA Fabric Switch 6

If there is a problem accessing a device connected to the MSA Fabric Switch 6, the source of the problem can be with the device, the switch, the host, or any of the connections between the host and device. Follow the steps outlined below to investigate the problem. The following is a description of possible symptoms:

1. Check the Global Status Indicator for power. The unit may not be plugged into the Modular SAN Array 1000 correctly.
2. Inspect the switch fault indicators for apparent problems. If the fault indicators are on, the switch may be faulty or the temperature may be out of defined limits.
3. Inspect the cabling between the switch and attached Fibre Channel devices. Check for loose, dirty, broken, or bent cabling and connectors. If a Compaq-supported Small Form Factor Pluggable transceiver (SFP) is in use, check that it is properly inserted and that the cable is properly seated.
4. Check the port status indicators.

Reading the Global Status Indicator

The indicators provide information about the status of the switch. This should be used as the first stage in troubleshooting. If either the serial or the Ethernet link to the switch is running, use the appropriate Command Line Interface command (See Appendix C, “Command Line Interface,” for the appropriate command). The Global Status Indicator indicators can be interpreted by reviewing Table 4-1.

Table 4-1: Global Status Indicator

Label	Color/Pattern	Interpretation	Possible Causes
Power	Green/ON	The unit is connected to an AC power source and the internal power supply is functioning.	This is the normal state when powered on.
	Green/OFF	There is no power within the switch.	The Fabric Switch 6 may not be plugged in to the MSA SAN Array 1000 correctly. The MSA SAN Array 1000 may be disconnected or the power cable is bad. The switch is faulty.
Fault	Amber/ON	Switch is running self test.	This is the normal self-test state.
		If the light remains on after 15 seconds, the switch failed the self-test.	If the test fails, the switch may be faulty.

continued

Table 4-1: Global Status Indicator *continued*

Label	Color/Pattern	Interpretation	Possible Causes
	Amber/OFF	Self test completed with no fault found.	Normal running state.
Initialize	Green/ON	Switch is re-initializing.	This is normal if not done excessively. Expect to encounter this when devices are being added or deleted from the Fibre Channel network. If this occurs too often, check for excessive LIPs.
	Green/OFF	Switch is not re-initializing.	Normal state.

Reading the Ethernet Indicators

Table 4-2: Ethernet Indicators

Label	Color/Pattern	Interpretation	Possible Causes
Active (Act)	Green/BLINKING	The switch is properly installed and registering network activity.	This blinks each time there is a packet on the network, even if the packet is not directed at the switch.
	Green/ON	The network link is up.	The network is up but there is no activity. If activity is expected, check the other systems. They may be at fault.
Link (link)	Green/ON	There is a network link established.	Normal state.

continued

Table 4-2: Ethernet Indicators *continued*

Label	Color/Pattern	Interpretation	Possible Causes
	Green/OFF	There is no network link.	<p>If this is off, then there is no connection to the network. One or more of the following could be the cause:</p> <p>The network is down for some reason. Check to see if other systems on the network are functioning.</p> <p>The switch is not connected to the network. Check the cable to see if it is seated properly. Try replacing the cable.</p> <p>The switch is not functioning. Is the GSI power showing to the switch? Can you communicate with it via the serial port?</p> <p>The switch may be connected to a network that is not 10Base T compatible. It could be 100BaseT only, or some other LAN link.</p>

Reading the Port Indicators

Table 4-3: Port Link Indicators

Port Top indicator	Port Bottom Indicator	Port Stat	Occurrence	Comments
Off	Off	Not active	Device not operating	
Off	Blinking green	Negotiating	Initial plug in	Negotiating between 2Gb and 1Gb.
Off	Green	Operational	Good connect and operating	
Off	Amber	Fault	Device/internal error	
Blinking amber	Blinking amber	Speed mismatch	Conflict defined speed	Both indicators on port blinking simultaneously.
Blinking green	Blinking green	Beaconing	MSA1000 feature	All port indicators blinking simultaneously.

Serial Communication Problems

The RS-232 interface can be the source of interface variations. If problems can be traced to the serial cable, check that the cable is plugged-in correctly and that it has the correct pin connections.

Connections

The following section describes the proper use of Compaq-supported Small Form Factor Pluggable Transceivers (SFP) and Fibre Channel cables.

Compaq-supported Small Form Factor Pluggables (SFP)

Use caution when handling SFPs. Take normal precautions to protect them from a static electrical discharge and any other damage:

IMPORTANT: Always wear an anti-static wrist strap when handling Compaq-supported SFPs. They are static sensitive.

- Leave the device in its anti-static bag until ready to install it.
- Hold the SFP by its edges and handle it carefully.
- Always follow the Compaq-supported SFP manufacturer's recommended procedures for cleaning the SFP. This is especially true of the type of solvent used for cleaning optical surfaces.

IMPORTANT: Do not install any SFP that appears physically damaged. This may result in permanent damage to the switch. Keep unused SFP connectors covered with the plugs that are shipped with them to prevent contamination from obscuring or attenuating the light signals.

Fibre Channel Cables

The MSA Fabric Switch 6 uses Fibre Channel cables to communicate with end-node devices. Loose or broken cables can cause a number of problems. Inspect the cabling between the MSA Fabric Switch 6 and attached Fibre Channel devices. Check for loose, dirty, broken, or bent cabling and connectors.

- Inspect the switch fault indicators for apparent problems.
- Check that the Compaq-supported SFP is properly inserted.
- Check the port status indicators.
- Check to see if the indicator located next to the special Fibre Channel interface cable connector is lit. If it is not, a viable connection to the Fibre Channel network has not been established.

Temperature Control

The MSA Fabric Switch 6 is designed to work in a normal room temperature environment, between 10° and 40° C (50° F to 104° F).

Preventive Maintenance Solutions

To protect the switch for longer use, Compaq recommends the following:

- Periodically vacuum the external surfaces of the switch to remove dust.
- Do not drop fiber optic cable connectors onto hard surfaces. This can cause internal glass fractures and intermittent signals.
- Keep unused cable ends covered to prevent contamination from obscuring or attenuating the light signals.

IMPORTANT: Always use an anti-static wrist strap while handling SFPs. These are static-sensitive devices.

- Keep unused Compaq-supported SFP connections covered to prevent contamination from obscuring or attenuating the light signals.
- Always follow the Compaq-supported SFP manufacturer's recommended procedures for cleaning the SFP. This is especially true of the type of solvent used for cleaning optical surfaces.
- Never insert foreign objects into optical transmit and receive ports.
- Do not bend fiber cable to less than a 3-inch bend radius.

Regulatory Compliance Notices

Federal Communications Commission Notice

Part 15 of the Federal Communications Commission (FCC) Rules and Regulations has established Radio Frequency (RF) emission limits to provide an interference-free radio frequency spectrum. Many electronic devices, including computers, generate RF energy incidental to their intended function and are, therefore, covered by these rules. These rules place computers and related peripheral devices into two classes, A and B, depending upon their intended installation. Class A devices are those that may reasonably be expected to be installed in a business or commercial environment. Class B devices are those that may reasonably be expected to be installed in a residential environment (personal computers, for example). The FCC requires devices in both classes to bear a label indicating the interference potential of the device as well as additional operating instructions for the user.

The rating label on the device shows which class (A or B) the equipment falls into. Class B devices have an FCC logo or FCC ID on the label. Class A devices do not have an FCC ID on the label.

Federal Communications Commission Notice

This equipment has been tested and found to comply with the limits for a Class A digital device, pursuant to Part 15 of the FCC Rules. These limits are designed to provide reasonable protection against harmful interference when the equipment is operated in a commercial environment. This equipment generates, uses, and can radiate radio frequency energy and, if not installed and used in accordance with the instructions, may cause harmful interference to radio communications. Operation of this equipment in a residential area is likely to cause harmful interference, in which case the user will be required to correct the interference at personal expense.

Modifications

The FCC requires the user to be notified that any changes or modifications made to this device that are not expressly approved by Compaq Computer Corporation may void the user's authority to operate the equipment.

Cables

Connections to this device must be made with shielded cables with metallic RFI/EMI connector hoods in order to maintain compliance with FCC Rules and Regulations.

Canadian Notice (Avis Canadien)

This Class A digital apparatus meets all requirements of the Canadian Interference-Causing Equipment Regulations.

Cet appareil numérique de la classe A respecte toutes les exigences du Règlement sur le matériel brouilleur du Canada.

European Union Notice

Products with the CE Marking comply with both the EMC Directive (89/336/EEC) and the Low Voltage Directive (73/23/EEC) issued by the Commission of the European Community.

Compliance with these directives implies conformity to the following European Norms (in brackets are the equivalent international standards):

- EN55022 (CISPR 22) - Electromagnetic Interference
- EN50082-1 (IEC801-2, IEC801-3, IEC801-4) - Electromagnetic Immunity
- EN60950 (IEC950) - Product Safety

Electrostatic Discharge

To prevent damage to the system, be aware of the precautions you need to follow when setting up the system or handling parts. A discharge of static electricity from a finger or other conductor may damage system boards or other static-sensitive devices. This type of damage may reduce the life expectancy of the device.

To prevent electrostatic damage, observe the following precautions:

- Avoid hand contact by transporting and storing products in static-safe containers.
- Keep electrostatic-sensitive parts in their containers until they arrive at static-free workstations.
- Place parts on a grounded surface before removing them from their containers.
- Avoid touching pins, leads, or circuitry.
- Always make sure you are properly grounded when touching a static-sensitive component or assembly.

Grounding Methods

There are several methods for grounding. Use one or more of the following methods when handling or installing electrostatic-sensitive parts:

- Use a wrist strap connected by a ground cord to a grounded workstation or computer chassis. Wrist straps are flexible straps with a minimum of 1 megohm \pm 10 percent resistance in the ground cords. To provide proper ground, wear the strap snug against the skin.
- Use heel straps, toe straps, or boot straps at standing workstations. Wear the straps on both feet when standing on conductive floors or dissipating floor mats.
- Use conductive field service tools.
- Use a portable field service kit with a folding static-dissipating work mat.

If you do not have any of the suggested equipment for proper grounding, have an Authorized Compaq Reseller install the part.

NOTE: For more information on static electricity, or for assistance with product installation, contact your Compaq authorized reseller.

Command Line Interface

Most of the configuration commands used to set up and maintain the MSA Fabric Switch 6 can be controlled from the main menu's first two options: Networking Parameters and Management. For more advanced functions, the MSA Fabric Switch 6 Management Utility offers a further level of complexity. This more advanced level of parameters operates from a command line interface (CLI).

This chapter includes information on:

- Invoking the Command Line Interface
- Using the Command Line Interface
- Setting up Zoning

The table below provides an overview of the commands available through the CLI.

Table C-1: Command Line Interface Summary

Command	Meaning
Beacon	Displays/modifies the beacon settings
Config	Displays the configuration settings for the switch backup/restore files
Exit	Exits the command line interface
Fabric	Displays the fabric information

continued

Table C-1: Command Line Interface Summary *continued*

Command	Meaning
FactDft	Loads the default factory settings
Help	Lists all implemented commands
HwCfg	Displays the hardware configuration
Log	Displays/modifies the event log settings
LogOut	Logs out of the user interface
NetCfg	Displays the switch network settings
NS	Displays the name server information.
PortCtl	Displays/modifies the port settings
PortReSet	Resets selected switch ports
PortStatS	Displays the port statistics
PortStatUs	Displays the port status
PortTp	Displays the port throughput for all ports
ReSeT	Resets the switch
SNMP	Displays/modifies the SNMP Mib2 settings
SwCtl	Displays/modifies the switch settings
SwStatE	Displays the switch state
SwStatUs	Displays the switch status
Temp	Displays/modifies the temperature settings
TftpDI	displays/modifies the download settings
Topology	Displays the topology information
Traps	Displays/modifies the SNMP trap settings

Invoking the Command Line Interface

The CLI can be called up by choosing **4.Command line interface** on the main menu. It will respond with a “cmd>” prompt, as shown in the following figure.

```
Embedded Switch - 6 Port
Model number:           229967-001
Firmware version:      PXX.X
Selftest status:       passed

2.  Networking settings
3.  Management settings
4.  Command line interface
5.  Logout
6.  Reset switch

> 4
```

Figure C-1: Main menu

Using the Command Line Interface

The CLI is a general-purpose ASCII line interface separated by carriage returns. The syntax can best be seen by typing “help.” More detailed information is available by typing “help” followed by a command name, as shown below:

```
cmd> help command_name

Beacon          Display/modify beacon settings
Config          Backup/restore switch configuration files
Exit            Exits command line interface
Fabric          Display fabric information
FactDft         Load default factory settings
Help            List of all commands implemented
HwCfg           Displays hardware configuration
Log             Display/modify Event log settings
LogOut          Logs user out of the system
NetCfg          Displays switch network settings
NS              Displays simple name server information.
PortCtl         Display/modify port settings
PortReSet      Resets selected switch ports
PortStatS       Display port statistics
PortStatUs      Display port status
PortTp          Displays port throughput for all ports
ReSeT          Reset switch
SNMP            Display/modify SNMP Mib2 settings
SwCtl           Display/modify switch settings
SwStateE        Display switch and port state
SwStatUs        Display switch status
Temp            Display/modify temperature settings
TftpDl          Display/modify TFTP download settings
Topology        Display topology information
Traps           Display/modify SNMP trap settings
```

Figure C-2: Help menu

By typing the Help command, you can access a list of all available commands along with a brief overview of the syntax. In addition, it is possible to assign values to various parameters by using the equal sign separated by spaces.

Logging Out of the CLI

The `logout` command screen in the CLI is the same as the `logout` option in the main menu.

```
Embedded Switch - 6 Port
Model number:          229967-001
Firmware version:     PXX.X
Selftest status:      passed

2.  Networking settings
3.  Management settings
4.  Command line interface
5.  Logout
6.  Reset switch
>5
```

Figure C-3: Logout screen

Exiting from CLI

The `Exit` command of the CLI returns the user to the main menu. The `Exit` command can be distinguished from the `Logout` command in that the user does not exit the program but remains logged in and retains the ability to select a new item from the main menu.

Reset

This command resets the switch.

Beacon

The `Beacon` command enables or disables the switch.

Syntax

Beacon On = Set Switch Beacon ON
Beacon Off = Set Switch Beacon OFF

Examples:

```
cmd> beacon
Beacon is on
```

Figure C-4: Beacon On command

Config

This command displays and modifies the switch configuration backup and configuration restore settings. It also activates the backup and restore function. Configuration backup writes the switch's configuration files to files specified by "file" on the TFTP server specified by the IP address. Configuration restore reconfigures the switch based on the files specified by "file" from the TFTP server specified by the IP address.

NOTE: When using the "backup" feature, some TFTP servers may not overwrite existing files. These TFTP servers will create a new file with modified filenames, resulting in "restore" not retrieving the expected file.

Syntax:

Config:	Display config backup/restore settings
Config File = <Filename>	Modify config backup/restore filename prefix
Config IP = <0.0.0.0>	Modify TFTP server IP address
Config Backup	Start configuration backup
Config Restore	Start configuration restore

Examples:

```
cmd> config
backup/restore filename prefix:  backup
backup/restore IP address:       127.0.0.1
```

Figure C-5: Config command**Exit**

Exits the command line interface and returns to the main menu.

Syntax

```
Exit
```

Examples:

```
cmd> Exit
```

Fabric

Displays all of the switches in the fabric.

Syntax

```
Fabric
```

Example:

```
cmd> fabric

DomainID   Priority   Principal World Wide Name
=====   =====   =====   =====
          1           0 yes       100000e024000001
          2           1 no        100000e022000201
          3           2 no        100000e024500111
```

Figure C-6: Fabric command

Factdft

Resets the switch in the factory default settings. CLI command factory defaults are:

Table C-2: Factory Defaults

CLI Command	User ID	Parameter	Default Value
Beacon	User User	On / Off	
Config	User User	Backup Filename Backup IP address	backup 127.0.0.1
Creditleak	Engineer Engineer Engineer Engineer	Enabled Time(sec) Threshold Delay(ms)	No 10 50 10

continued

Table C-2: Factory Defaults *continued*

CLI Command	User ID	Parameter	Default Value
Log	User Admin/engineer User Admin/engineer User	log level filter log module filter console display level filter console display module filter telnet display level filter telnet display module filter.115 upload TFTP file name upload TFTP IP address port message level Fatal, Warn, Status & Inform All modules None All modules None All modules	eventlog.txt 127.0.0.1 0
PortCtl	User User User User User User Na Na Na Na	Offline Public Type Speed Heart Cost Admin status Transfer delay Dead interval Retransmit interval	No Public Auto Auto 20s 1000 OSRP enable 1 80 5
Snmp	User User User	Name Contact Location	Null Null Null

continued

Table C-2: Factory Defaults *continued*

CLI Command	User ID	Parameter	Default Value
Swctl	User	Switch name Desired domain Priority Translation Send FAN Min LSA arrival Min LSA interval LSA refresh interval LSA max age	FC Switch 1 254 off off 1 5 1800 3600
Temp	User	Threshold	50c
Tftpd	User	Download file name TCTP IP address Request timeout Request packet retries Data timeout Data packet retries Reset after download	syspkg.bin 127.0.0.1 5000ms 6 500ms 60 No
Traps	User		All traps removed

Syntax

FactDft

Example:

```
cmd> factdft
Resetting the switch to factory defaults will be dis-
ruptive to normal switch operation.

Do you wish to continue? (y/n): y
```

Figure C-7: Factdft command

Help

Lists all of the commands. Help is also used with a command name to describe a command function.

Syntax

```
Help
Help <command>
```

Help — Displays the list of commands that are available from this interface.

Help <command> — Displays a description of the command specified.

command The name of the command for which you want help.

Examples:

```
cmd> help

Compaq Fabric Switch

Legend:
  < > - required parameter
  [ ] - optional switch
Syntax:
  Help          List of commands.
  Help <command> Detailed help for specified command.
Commands/subcommands are not case sensitive.
Commands/subcommands can be shortened by using the capitalized
letters in the command/subcommand.
```

Figure C-8: Help command initial screen

Beacon	Display/modify beacon settings
Config	Backup/restore switch configuration files
Exit	Exits command line interface
Fabric	Display fabric information
FactDft	Load default factory settings
Help	List of all commands implemented
HwCfg	Displays hardware configuration
Log	Display/modify Event log settings
LogOut	Logs user out of the system
NetCfg	Displays switch network settings
NS	Displays simple name server information.
PortCtl	Display/modify port settings
PortReSet	Resets selected switch ports
PortStatS	Display port statistics
PortStatUs	Display port status
PortTp	Displays port throughput for all ports
ReSeT	Reset switch
SNMP	Display/modify SNMP Mib2 settings
SwCtl	Display/modify switch settings
SwStatE	Display switch and port state
SwStatUs	Display switch status
Temp	Display/modify temperature settings
TftpDl	Display/modify TFTP download settings
Topology	Display topology information
Traps	Display/modify SNMP trap settings

Figure C-9: Supported commands

Hwcfg

Displays the hardware configuration of the switch.

Syntax

HwCfg

Example:

```

cmd> hwcfg
Banner:                               Embedded Switch - 6 Port
Serial number:                         P4658X43WKT02J
Firmware version:                      PXX.X
Ethernet MAC address:                  00e02411ba59
FC MAC address:                        00e02411ba5a
Switch WWNN:                           100000e02411ba5a
Number ports:                          6

```

Figure C-10: Hwcfg command**Log**

This command will display and modify the event-log settings. When an event occurs, if the event's severity matches the "LogLevFilter" setting, the event will be logged into the event-log buffer. If the event's severity matches the DispLevFilter setting, the event will be displayed on the console. "List" will display the entries contained in the event-log buffer. "Upload" will upload the event-log entries to the server specified by "Tftpplp" into a file specified by "Tftp Filename." Press **Ctrl-C** to temporarily disable the event log display. Press **Ctrl B** to enable the event log display.

Syntax

Log	Display event-log settings
Log LogLevFilter = <level> filter	Modify the event-log level filter
Log LogModFilter = <level> filter	Modify the event-log module filter
Log DispLevFilter = <level> display level filter	Modify the event-log display level filter
Log DispModFilter = <level> display module filter	Modify the event-log display module filter
Log PrtMsgLvl <prt> = <num> level	Modify the port message level

Log LogInterval = <int> interval (ms)	Modify the event-log min
Log TftpFilename = <fname>	Modify TFTP server filename
Log TftpIp = <xx.xx.xx.xx> address	Modify TFTP server IP
Log List event-log	Display entries in the
Log Upload TFTP server	Upload event-log entries to

<level>: d - debug; i - information; w - warning; f - fatal; s - status; g - gsos; n-none
<mod>: hex bit field

Example (to set DispLevFilter to debug, warning, fatal):

```
Log dlf = dwf
```

Example (to turn LogLevFilter off):

```
Log llf = n
```

Example:

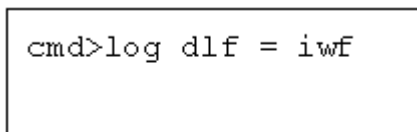

```
cmd>log dlf = iwf
```

Figure C-11: Log dlf command

LogOut

Logs the user out of the system.

Syntax

```
LogOut
```

Example:

```
cmd> Logout
Login:
```

Figure C-12: Logout command**NetCfg**

Displays switch network settings.

Syntax:

```
Netcfg
```

Examples:

```
cmd> netcfg
Ethernet IP Address:      127.0.0.1
Ethernet Subnetmask:     255.255.255.0
Gateway Address:        0.0.0.0
```

Figure C-13: Netcfg command**NS**

Displays the local and global name server (NS) table entries.

Syntax

```
NS
NS [/d]
NS All
NS All [/d]
```

Where setting the /d variable causes all entries to display without pausing to wait for user interaction.

NS - Displays local name server entries

NS All - Displays local and global name server entries

Examples:

```
cmd> ns
PortID:01ef01; PortType:NL; WWNN:100000e024000001;
WWPN:210500e024000001
COS:3; NodeIP:0.0.0.0; PortIP:0.0.0.0
```

Figure C-14: NS command

PortCtl

Displays and modifies the port control settings.

Syntax

```
PortCtl
PortCtl <port_number> Public = <public_state>
PortCtl <port_number> Type = <port_type>
PortCtl <port_number> Speed = <port_speed>
PortCtl <port_number> Heartbeat = <heartbeat_rate>
PortCtl <port_number> Cost = <routing_cost>
```

where *port_number* = a valid port number for the Fabric Switch between 1 and 6.
Use the value 'all' if you want the command to apply to all ports.

PortCtl— Displays the port control settings.

PortCtl <port_number> Offline = <offline_state> — Sets an individual port or all ports online or offline.

offline_state variables	Description
<i>yes</i>	Sets individual port or all ports to offline state.
<i>no</i>	Sets individual port or all ports to online state.

PortCtl <port_number> Type = <port_type> — Sets the port type variable for an individual port or all ports.

port_type variables	Description
<i>auto</i>	Sets individual port or all ports to autonegotiate their port type.
<i>FL</i>	Sets individual port or all ports to the FL port type.
<i>F</i>	Sets individual port or all ports to the F port type.

PortCtl <port_number> Speed = <port_speed> — Sets the port type variable for an individual port or all ports.

port_type variables	Description
<i>auto</i>	Sets individual port or all ports to autonegotiate their port speed.
<i>1G</i>	Sets individual port or all ports to operate at 1 Gbps.
<i>2G</i>	Sets individual port or all ports to operate at 2 Gbps

PortCtl <port_number> Heartbeat = <heartbeat_rate> — Sets the heartbeat rate variable for an individual port or all ports.

heartbeat_rate variables	Description
<i>5 -50</i>	Sets the heartbeat rate between 5 and 50 seconds.

PortCtl <port_number> Cost = <routing_cost> — Sets the routing cost variable for an individual port or all ports.

routing_cost variables	Description
100 -5000	Sets the routing cost between 100 and 5000.

Examples:

```
cmd> portctl

Port  Offline  Public  Type    Speed  Heart  Cost
====  =====  =====  =====  =====  =====  =====
  1   online   public  Auto    Auto    20    1000
  2   online   public  Auto    Auto    20    1000
  3   online   public  Auto    Auto    20    1000
  4   online   public  Auto    Auto    20    1000
  5   online   public  Auto    Auto    20    1000
  6   online   public  Auto    Auto    20    1000
```

Figure C-15: PortCtl command

```
cmd> portctl 5 offline = yes

Port  Offline  Public  Type    Speed  Heart  Cost
====  =====  =====  =====  =====  =====  =====
  5   offline  public  Auto    Auto    20    1000
```

Figure C-16: PortCtl offline command

Syntax:

PortCtl <port_number> offline = <offline_state>

```
cmd> portctl 5 public = no
Port  Offline  Public  Type      Speed  Heart  Cost
====  =====  =====  =====  =====  =====  =====
5    online   private Auto      Auto   20    1000
```

Figure C-17: PortCtl public command

Syntax:

```
PortCtl <port_number> public = <public_state>
```

```
cmd> portctl 5 Type = FL
Port  Offline  Public  Type      Speed  Heart  Cost
====  =====  =====  =====  =====  =====  =====
5    online   public  FL port   Auto   20    1000
```

Figure C-18: Portctl type command

Syntax:

```
PortCtl <port_number> Type = <port_type>
```

```
cmd> portctl 5 Speed = 1G
Port  Offline  Public  Type      Speed  Heart  Cost
====  =====  =====  =====  =====  =====  =====
5    online   public  Auto      Auto   20    1000
```

Figure C-19: PortCtl speed command

Syntax:

```
PortCtl <port_number> Speed = <port_speed>
```

```
cmd> portctl 5 Heartbeat = 30
Port  Offline  Public  Type      Speed  Heart  Cost
====  =====  =====  =====  =====  =====  =====
5    online   public  Auto      Auto   30    1000
```

Figure C-20: PortCtl heartbeat command

Syntax:

PortCtl <port_number> Heartbeat = <heartbeat_rate>

cmd> portctl 5 cost = 2000						
Port	Offline	Public	Type	Speed	Heart	Cost
====	=====	=====	=====	=====	=====	=====
5	online	public	Auto	Auto	20	2000

Figure C-21: PortCtl cost command

Syntax:

PortCtl <port_number> Cost = <routing_cost>

PortReSet

This command displays/resets statistic counters for the specified ports.

Syntax:

PortStatS Display statistic for all ports
 PortStatS <port#> Display statistic for specified ports
 PortStatS /r Reset stat counters for all ports
 PortStatS <<port#> /r Reset stat counters for specified ports

PortStatS

Displays port statistics and resets port statistics counters.

Syntax

PortStatS
 PortStatS <port_number>
 PortStatS /r
 PortStatS <port_number> /r

where *port_number* = a valid port number for the Fabric Switch between 1 and 6.

PortStatS—Displays statistics for all ports on the switch.

PortStats <port_number> — Displays statistics for the port specified on the switch.

PortStats /r— Resets the statistics counters for all ports on the switch.

PortStats <port_number> — Resets the statistics counters for the port specified on the switch.

Examples:

```
cmd> portstats
```

#	Frame Tx	Frame Rx	Word Tx	Word Rx	Link Fail	Invlid CRC	Invlid TxWds	PrmSeq Errs	Loss Sig	Loss Sync	Frame LenEr
==	=====	=====	=====	=====	=====	=====	=====	=====	=====	=====	=====
1	0.0	0.0	0.0	0.0	0.0	0.0	0.0	0.0	20.9K	86.4K	0.0
2	0.0	0.0	0.0	0.0	0.0	0.0	0.0	0.0	43.6K	123.6K	0.0
3	0.0	0.0	0.0	0.0	0.0	0.0	0.0	0.0	15.5K	95.4K	0.0
4	35.0	1.7K	2.5K	84.5K	0.0	0.0	9.0	0.0	59.8K	94.9K	0.0
5	0.0	0.0	0.0	0.0	0.0	0.0	10.0	0.0	24.4K	104.3K	0.0
6	0.0	4.7K	0.0	229.8K	0.0	0.0	0.0	0.0	0.0	0.0	0.0

Figure C-22: Portstats command

PortStatUs

Displays port status.

Syntax

```
PortStatUs
PortStatUs <port#>
```

Portstatus—Displays port status for all ports on the switch.

Portstatus <port_number> <port_number> .. — Displays port status for the port specified on the switch.

Examples:

```
cmd>portstatus
ID Port   WWN              Media      Type  Type  Speed Speed  Port
#  ID     Name            Type       Cfg   Curr  Cfg   Curr  Status
== =====
1  010100  200100e02411afc2 SFP GBIC NA  Auto  Unknown Auto  2gbps No media
2  010200  200200e02411afc2 Fixed SW  Auto  Unknown Auto  2gbps Link down
3  010300  200300e02411afc2 Fixed SW  Auto  Unknown Auto  2gbps Link down
4  010400  200400e02411afc2 Fixed SW  Auto  F_port Auto  2gbps Link active
5  010500  200500e02411afc2 Fixed SW  Auto  Unknown Auto  2gbps Link down
6  010600  200600e02411afc2 Internal  Auto  Unknown Auto  2gbps Link down
```

Figure C-23: Portstatus command

```
cmd>portstatus 1 2
ID Port   WWN              Media      Type  Type  Speed Speed  Port
#  ID     Name            Type       Cfg   Curr  Cfg   Curr  Status
== =====
1  010100  200100e02411afc2 SFP GBIC NA  Auto  Unknown Auto  2gbps No media
2  010200  200200e02411afc2 Fixed SW  Auto  Unknown Auto  2gbps Link down
```

Figure C-24: Portstatus with port number

Syntax:

PortStatUs <port_number>

PortTp

Continuously display the throughput for all of the ports. Press any key to stop the display.

Syntax

PortTp

Example:

```
cmd> portTp
  1      2      3      4      5      6
-----
1.0     1.0     1.0     1.0     1.0     1.0
```

Figure C-25: Porttp command**ReSeT**

Resets the Switch

Syntax

Reset

Example:

```
cmd> reset
Do you wish to reset the switch? (y/n): y
```

Figure C-26: Reset command**SNMP**

Displays and modifies the SNMP system variables.

Syntax

```
SNMP
SNMP Name = <name_text>
SNMP Con = <contact_text>
SNMP Loc = <location_text>
```

This command displays or modifies the MIB2 system strings. System contact can contain three pieces of information: name, email address, and phone number. Use “|” to separate the name, email address, and phone number fields. For example,
JohnDoe | jdoe@dotcom.com | 555-1212

SNMP— Displays the System Description, System Object ID, System Name, System Contact, and System Location for the switch.

SNMP Name = <name_text> — Sets the SNMP Name for the switch to the text typed in place of the *name_text* variable.

SNMP Con = <contact_text> — Sets the SNMP Contact for the switch to the text typed in place of the *contact_text* variable.

SNMP Loc = <location_text> — Sets the SNMP Location for the switch to the text typed in place of the *location_text* variable.

Examples:

```
cmd> SNMP
System description: Compaq Fabric Switch
System object ID:  1.3.6.1.4.1.1754.12131
System name: Finance 1
System contact: Administrator
System location: Data Center 4
```

Figure C-27: SNMP command

```
cmd> SNMP Name = Finance 1
System description: Compaq Fabric Switch
System object ID:  1.3.6.1.4.1.1754.12131
System name:      Finance 1
System contact:
System location:
```

Figure C-28: SNMP name = command

```
cmd> SNMP Con =      Administrator
System description:  Compaq Fabric Switch
System object ID:    1.3.6.1.4.1.1754.12131
System name:         Finance 1
System contact:      Administrator
System location:
```

Figure C-29: SNMP con command

```
cmd> SNMP Loc =      Data Center 4
System description:  Compaq Fabric Switch
System object ID:    1.3.6.1.4.1.1754.12131
System name:         Finance 1
System contact:      Administrator
System location:     Data Center 4
```

Figure C-30: SNMP loc command

SwCtl

Displays and modifies the switch control settings.

Syntax

SwCtl settings	Display switch control settings
SwCtl Domain = <1..239>	Set desired switch domain
SwCtl Priority = <1..255>	Set switch priority
SwCtl TRANslation = <ON/OFF> on/off	Turns address translation on/off
SwCtl SendFan = <ON/OFF> notification on/off	Turns fabric address notification on/off
SwCtl CirCumUpTime	Clear cumulative up time
SwCtl Forceiod = <ON/OFF> Delivery on/off	Turn force In-Order-Delivery on/off
SwCtl ForceiodDelay = <1..60> Delivery Delay in seconds	Set Force In-Order-Delivery Delay in seconds

SwStatE

Displays the switch and port state.

Syntax

Swstate

Example:

```
cmd> swstate
Switch name:           Terje Array-Switch1
Switch WWN:            100000e024000001
Switch configured domain: 1
Switch current domain: 1
Switch role:           principal
```

Figure C-31: Swstate command

```

Ports data:
ID Port   WWN              Media      Type  Type  Speed Speed  Port
# ID     Name             Type       Cfg   Curr  Cfg   Curr  Status
== =====
1 010100 200100e02411afc2 SFP GBIC NA Auto  Unknown Auto 2gbps No media
2 010200 200200e02411afc2 Fixed SW   Auto  Unknown Auto 2gbps Link down
3 010300 200300e02411afc2 Fixed SW   Auto  Unknown Auto 2gbps Link down
4 010400 200400e02411afc2 Fixed SW   Auto  F_port Auto 2gbps Link active
5 010500 200500e02411afc2 Fixed SW   Auto  Unknown Auto 2gbps Link down
6 010600 200600e02411afc2 Internal   Auto  Unknown Auto 2gbps Link down

```

Figure C-32: Swstate command ports data information

Swstatus

Displays the switch status.

Syntax

```
swstatus
```

Example:

```

cmd>swstatus
This firmware supports file compression.
Selftest status:           passed
Power LED state:           Flashing green
Temperature:               28 c (threshold: 60 c)
Switch up time:            0:15:06 hr:min:sec
Cumulative up time:        0:15:06 hr:min:sec
TFTP download state:       Complete
TFTP download status:      Successful

```

Figure C-33: Swstatus command

Temp

Displays the current temperature of the switch and the threshold setting for it. It also allows you to modify the switch temperature threshold.

Syntax

```
Temp  
Temp = <temperature_threshold>
```

Temp — Displays the current temperature of the switch and the current threshold setting.

Temp = <*temperature_threshold*> — Sets the temperature threshold for the switch to the value typed in place of the *temperature_threshold* variable.

```
cmd> temp = 52  
Current temperature: 43 c  
Temperature threshold: 52 c
```

Figure C-34: Temp command

TftpDl

Displays and modifies TFTP download settings for the switch.

Syntax

```
TftpDl
TftpDl = <file_name>
TftpDl = <ip_address>
TftpDl ReqTimeout = <req_timeout>
TftpDl ReqRetry = <req_retries>
TftpDl DataTimeout = <data_timeout>
TftpDl DataRetry = <data_retries>
TftpDl Reset = <reset_state>
TftpDl Changeprimary
TftpDl Start
```

TftpDl— Displays the TFTP download settings for the switch.

TftpDl = <file_name> — Sets the file name of the file to be downloaded from the TFTP server to the text typed in place of the *file_name* variable.

TftpDl = <ip_address> — Sets the IP address of the TFTP server where you want to download a code image from to the number typed in place of the *ip_address* variable.

TftpDl ReqTimeout = <req_timeout> — Sets the time in milliseconds during which the switch will request the TFTP server to download the image file before giving up to the number typed in place of the *req_timeout* variable.

TftpDl ReqRetry = <req_retries> — Sets the number of attempts the switch will request the server to download the image file before giving up to the number typed in place of the *req_retries* variable.

TftpDl ReqDataTimeout = <data_timeout> — Sets the time in milliseconds during which the switch will request the TFTP server to download a data packet before giving up to the number typed in place of the *data_timeout* variable.

TftpDl DataRetry = <data_retries> — Sets the number of attempts the switch will request the server to download a data packet before giving up to the number typed in place of the *req_retries* variable.

TftpDl Reset = <reset_state> — This setting determines if the switch will automatically reboot after download.

Variables Description

reset_state

yes Sets switch to automatically reboot after a new boot image has been down loaded to it.

no Sets switch to not automatically reboot after a new boot image has been downloaded to it.

TftpDl ChangePrimary— Sets the backup image as the primary image.

TftpDl Start— Starts the download process using the variables configured.

Examples:

```

cmd> tftpd1
TFTP download file name: C8025i76.bin
TFTP IP address:         172.18.99.39
Request timeout:         5000 ms
Request packet retries:  6
Data timeout:            500 ms
Data packet retries:     60
Reset after download:    No
Current image name:      C8app.bin, rev: I76
Primary image name:      C8app.bin, rev: I76
Backup image name:       None
    
```

Figure C-35: TftpDl command

Topology

Displays the topology information for one or all of the switches in the fabric.

Syntax

```
Topology
Topology [/d]
Topology <domain_Id_number>
```

`Topology`— Displays the information for all of the switches in the network.

`Topology /d`— Displays the information for all of the switches in the network without pausing and prompting the user to continue.

`Topology <domain_Id_number>` — Displays the information for the specified switch whose domain ID number is typed in place of the *domain_Id_number* variable.

Example:

```
cmd> topology /d
Local Out Neighbor Neighbor Link
DomainID Port DomainID Port Cost
=====
1 2 3 5 1000
3 3 6 1000.144
Local Out Neighbor Neighbor Link
DomainID Port DomainID Port Cost
=====
3 1 5 1 1000
2 5 3 1000
5 1 2 1000
6 1 3 1000
Local Out Neighbor Neighbor Link
DomainID Port DomainID Port Cost
=====
4 2 3 4 1000
3 3 3 1000
Local Out Neighbor Neighbor Link
DomainID Port DomainID Port Cost
=====
5 1 3 1 1000
3 3 2 1000
cmd>
```

Figure C-36: Topology command**Traps**

This command displays and modifies the trap entries. The <ip.port> specifies the trap IP address and trap port address. The format for <ip.port> is ip.ip.ip.port.8 trap entries are supported. Valid range for 'ip' is 0 – 255. Valid range for 'port' is 1-2147483647, normally 162.

Syntax

```
Traps
Traps Add <ip_address,port_number>
Traps Delete <ip_address,port_number>
Traps Filter <ip_address,port_number>
Traps State <ip_address,port_number>
```

Traps— Displays trap entry settings.

Traps Add *<ip_address,port_number>* — This command is used to add new trap recipients. Up to eight trap recipients are supported. The command variables are defined as follows:

Variables	Description
<i>ip_address</i>	Sets the IP address of the SNMP trap recipient that you want to add.
<i>port_number</i>	Sets the port number of the SNMP trap recipient that you want to add. The default is 162.

Traps Delete *<ip_address,port_number>* — This command is used to delete trap recipients from the recipients list. The command variables are defined as follows:

Variables	Description
<i>ip_address</i>	The IP address for the trap recipient that you want to remove from the recipients list.
<i>port_number</i>	The port number for the trap recipient that you want to remove from the recipients list.

Traps Filter *<ip_address,port_number> = <trap_type>* — This command is used to set the type of traps that you want forwarded to a particular SNMP trap recipient. The command variables are defined as follows:

Variables	Description
<i>ip_address,port number</i>	
<i>ip_address</i>	The IP address of the SNMP trap recipient that you want to create a filter for
<i>port_number</i>	The port number of the SNMP trap recipient that you want to create a filter for
<i>trap_type</i>	
<i>EMer</i>	Filters for traps of the type “Emergency”. Highest level of severity
<i>Alert</i>	Filters for traps of the type “Alert”.
<i>Crit</i>	Filters for traps of the type “Critical”.
<i>ERr</i>	Filters for traps of the type “Error”.
<i>Warn</i>	Filters for traps of the type “Warn”.
<i>Notify</i>	Filters for traps of the type “Notify”.
<i>Info</i>	Filters for traps of the type “Info”.
<i>Debug</i>	Filters for traps of the type “Debug”.
<i>Mark</i>	Filters for traps of the type “Mark”. Lowest level of severity.

Traps State = *<ip_address,port_number>* = *<trap_state>* — This command is used to set the state of a particular SNMP trap recipient as active or inactive. The command variables are defined as follows:

Variables	Description
<i>ip_address, port number</i>	
<i>ip_address</i>	The IP address of the SNMP trap recipient whose state you want to set.
<i>port_number</i>	The port number of the SNMP trap recipient whose state you want to set.
<i>trap_state</i>	
<i>active</i>	Sets the specified port recipient to the “Active” state. Traps configured to be sent to this device will be forwarded to it.
<i>inactive</i>	Sets the specified port recipient to the “Inactive” state. Traps configured to be sent to this device will not be forwarded to it.

Examples:

```

cmd> traps
  IP address      Port  Filter  State
172.18.97.122    162  alert   active
172.18.97.205    162  warning active

```

Figure C-37: Traps command

```

cmd> traps Add
  IP address      Port  Filter  State
172.18.97.122    162  alert   active
172.18.97.205    162  warning active

```

Figure C-38: Traps add command

```
cmd> traps delete 172.18.97.122,162
  IP address      Port  Filter  State
172.18.97.205    162  warning active
```

Figure C-39: Traps delete command

```
cmd> Traps filter 172.18.97.122,162 = Alert
  IP address      Port  Filter  State
172.18.97.122    162  alert   active
172.18.97.205    162  warning active
```

Figure C-40: Traps filter command

```
cmd> traps state 172.18.97.205,162 = inactive
  IP address      Port  Filter  State
172.18.97.205    162  warning inactive
```

Figure C-41: Traps state command

Setting up Zoning

Zoning is a function of the MSA Fabric Switch 6 that allows you to create isolated Fibre Channel networks with a limited number of connected devices. By limiting the number of devices in a zone, you can obtain more robust performance and enhance your access protection.

Zoning is compliant with the following standards:

- FC-SW-2
- FC-GS3
- FC-MI

This section describes the zoning functions supported by the MSA Fabric Switch 6. It describes zoning at the individual switch and describes how the `merge` command functions are used to support zoning across a Fabric.

Zoning Elements

Before performing zoning, you must understand the following zoning elements:

- Zone Members
- Zones
- Zone Sets



CAUTION: Never add a zoned switch to an established fabric that has no zoning. If a switch configured with zoning is added to a fabric that has no configured zoning, the fabric's HBAs and targets will no longer be able to communicate and the traffic in the fabric will be disrupted. For best results, only add a switch configured with zoning to a fabric configured with same zoning configuration.

Zone Members

Zone members are Fibre Channel edge devices that are identified by their World Wide Port Name (WWPN). Any device that you want to include in a zone must be identified as a zone member. While internally the zone members are tracked by their WWPN, you can create a Zone Member Name that acts as an alias for the device. This makes it easier to identify the devices during configuration and operation. The following are examples of Fibre Channel devices that can be named as zone members:

- Servers
- Raid systems
- Disk drives
- Tape libraries

IMPORTANT: The World Wide Node Name (WWNN) of the Fibre Channel device cannot be used to create a zone member. WWNN-based zoning is expressly prohibited in the FC-MI standard. Use World Wide Port Name (WWPN) to create a zone member.

Zones

Zones are logical entities that represent groupings of zone members. Each zone must be assigned a unique zone name when it is defined.

Zone Sets

Zone sets are logical entities that represent groupings of zones. They define a zoning configuration. Each zone set is assigned a unique zone set name when it is defined. The MSA Fabric Switch 6 allows storing of multiple zone sets. However, only one of these zone sets can be active at a time. The other zone sets can be used as backup, trials, or other user-defined configurations.

Naming Rules for Zone Members, Zones, and Zone Sets

Zone member, zone, and zone set names must follow these rules:

- Names must be between 1 and 64 characters long
- Characters used in names must be 7 bit ASCII characters
- The first character of a name must be a letter (a-z) and can be either upper case or lower case
- Other characters of the name (any characters besides the first character) can be a letter (a-z, either upper or lower case), a number (0-9), or a symbol (\$ - ^ _).
- No spaces are allowed in the name

Zoning Limitations for Zone Members, Zones, and Zone Sets

There are zoning limitations for individual switches and fabrics. See Table C-3 for maximum limitations.

Table C-3: Switch and Fabric Zoning Limitations

Item	Maximum
Number of Zone Sets	4
Number of Zones	64
Number of Zone Members	64

Using the CLI to Configure Zoning

This section describes how to use the CLI to configure zone members, zones, and zone sets and apply the new or edited zone configurations to the switch.

To ensure uninterrupted operation of the MSA Fabric Switch 6, a three-stage process was developed for configuring zoning using CLI:

- Stage one: creating the pending table
- Stage two: verifying the zoning configuration in the pending table
- Stage three: writing the pending table to the active table

The zoning configuration procedures are detailed in the following paragraphs and use the following scenario.

Assume the following:

- Server1 needs to access Disk1 exclusively for Operating System boot (OS Boot).
- Server1 needs to access Raid1 for shared storage.
- Server1 needs to access Tape1 for backup.
- Server2 needs to access Disk2 exclusively for Operating System boot.
- Server2 needs to access Raid1 for shared storage.
- Server2 needs to access Tape1 for backup.

Before you begin to configure your zoning, you must first define the zone members, zones, and zone sets that you will need.

Table C-4 lists the zone members, zones, and zone sets being used in this example and indicates what members the zones and the zone sets contain.

Table C-4: Example Zoning Configuration

Zone Members	Zones	Zone Set
Server1 WWPN: 1000000102421303	Web_Zone	MIS_NT_CLSTR1_SAN1
Disk 1 WWPN: 2100005004d02f78	Web_Zone	
Tape1 WWPN: 210000010241ff73	Web_Zone and Mail_Zone	
RAID1 WWPN: 210000010249a7ab	Web_Zone and Mail_Zone	
Server2 WWPN: 100000a0c99ae47a	Mail_Zone	
Disk2 WWPN: 200000600819ae48	Mail_Zone	

In this example, the Zone Set MIS_NT-CLSTR1_SAN1 contains two zones:

- Web_Zone contains the following Zone Members: Server1, Disk1, RAID1, and Tape1.
- Mail_Zone contains the following Zone Members: Server2, Disk2, RAID1, and Tape1.

Stage one: Creating the Pending Table

Before configuring the zoning, it is helpful to decide on the names you will use for your zone sets, zones, and zone members.

During the configuration, you first create the largest group (zone sets), then create the next largest group (zones), and last create the individual entities (zone members).

After you have created your zone members using their WWPN, you can assign more user-friendly names to your zone members.

The steps of stage one include:

- Viewing and clearing the pending table
- Creating the zone set
- Adding zones to the zone set
- Adding zone members to the zones
- Changing the names of the zone members (optional)
- Enabling the pending table zone set

Viewing and Clearing the Pending Table

Start by checking what has already been created:

1. View the pending table.

```
cmd> zone pending
Inactive zoneset [set1] contains 1 zone (s)
    zone [ntgroup1] contains 0 member(s)
Inactive Zoneset [set2] contains 1 zone(s)
    zone [solaris1] contains 0 members)
Inactive zoneset [set3] contains 1 zone(s)
    zone [ntgroup2] contains 0 member(s)
```

NOTE: You can also use abbreviated forms of CLI commands. For example, instead of using “cmd> zone pending,” you can use “cmd> zn pn.” For a list of the CLI abbreviations, type “help.”

2. Clear the existing pending table.

```
cmd> zone clear
Cleared pending zone configuration.
```

3. Display the pending table to verify that it was cleared.

```
cmd> zone pending
Zone table is empty.
```

Creating the Zone Set

Create your zone set using the name you already defined (see Table C-4).

```
cmd> zone addzs MIS_NT_CLSTR1_SAN1
Zoneset [MIS_NT_CLSTR1_SAN1] added.
Changes will only take effect after a 'zone write' command!!
```

Adding zones to the zone set

Add zones to your zone set using the names you already defined (see Table C-4).

```
cmd> zone addzn MIS_NT_CLSTR1_SAN1 Web_Zone Mail_Zone
Zone [Web_Zone] added to zoneset [MIS_NT_CLSR1_SAN1].
Zone [Mail_Zone] added to zoneset [MIS_NT_CLSTR1_SAN1].
```

Changes will only take effect after a 'zone write' command!!

Adding zone members to the zones

Add zone members to your zones using the names you have already defined, (see Table C-4).

```
cmd> zn addzm Web_Zone 1000000102421303 2100005004d02f78
Zone member [1000000102421303] added to zone [Web_Zone].
Zone member [2100005004d02f78] added to zone [Web_Zone].
```

Changes will only take effect after a 'zone write' command!!

```
cmd> zn addzm Web_Zone 210000010241ff73 210000010249a7ab
Zone member [210000010241ff73] added to zone [Web_Zone].
Zone member [210000010249a7ab] added to zone [Web_Zone].
```

Changes will only take effect after a 'zone write' command!!

```
cmd> zn addzm Mail_Zone 100000a0c991a47a 200000600819ae48
Zone member [100000a0c991a47a] added to zone [Mail_Zone].
Zone member [200000600819ae48] added to zone [Mail_Zone].
```

Changes will only take effect after a 'zone write' command!!

```
cmd> zn addzm Mail_Zone 210000010241ff73 210000010249a7ab
Zone member [210000010241ff73] already exists, added to zone
[Mail_Zone].
Zone member [210000010249a7ab] already exists, added to zone
[Mail_Zone].
```

Changes will only take effect after a 'zone write' command

Changing the names of the zone members (optional)

To assign a user-friendly names to your newly created zone members, first display the zone members and then change the names.

1. Display the zone members.

```
cmd> zone pending displayzm
```

WWPN	Name
1000000102421303	[WWN-1000000102421303]
2100005004d02f78	[WWN-2100005004d02f78]
210000010241ff73	[WWN-210000010241ff73]
210000010249a7ab	[WWN-210000010249a7ab]
100000a0c991a47a	[WWN-100000a0c991a47a]
200000600819ae48	[WWN-200000600819ae48]

2. Change the zone member name, as illustrated in Table C-4.

```
cmd> zone renzm WWN-1000000102421303 Server1
Renamed zonemember [WWN-1000000102421303] to [Server1].
Changes will only take effect after a 'zone write'
command!!
```

```
cmd> zone renzm WWN-2100005004d02f78 Disk1
Renamed zonemember [WWN-2100005004d02f78] to [Disk1].
Changes will only take effect after a 'zone write'
command!!
```

```
cmd> zone renzm WWN-210000010241ff73 Tape1
Renamed zonemember [WWN-210000010241ff73] to [Tape1].
Changes will only take effect after a 'zone write'
command!!
```

```
cmd> zone renzm WWN-210000010249a7ab Raid1
Renamed zonemember [WWN-210000010249a7ab] to [Raid1].
Changes will only take effect after a 'zone write'
command!!
```

```
cmd> zone renzm WWN-100000a0c991a47a Server2
Renamed zonemember [WWN-100000a0c991a47a] to [Server2].
Changes will only take effect after a 'zone write'
command
```

```
cmd> zone renzm WWN-200000600819ae48 Disk2
Renamed zonemember [WWN-200000600819ae48] to [Disk2].
Changes will only take effect after a 'zone write'
command!!
```

Enabling the pending table zone set

Enable the zone set in the pending table, so that when it is written to the active table it will be activated:

```
cmd> zone enable MIS_NT_CLSTR1_SAN1
Zoneset [MIS_NT_CLSTR1_SAN1] enabled.
```

Stage Two: Verifying the Zoning Configuration in the Pending Table

Make sure that you have the correct configuration by viewing your newly created pending tables. There are four different ways you can confirm that your pending tables are correct.

- Viewing all zone sets, their zones, and zone members in the pending table
- Viewing the zone set in the pending table
- Viewing the zones in the pending table
- Viewing the zone members in the pending table

Viewing the Zone Set, its Zones, and its Zone Members in the pending table

To display all zone sets, zones, and zone members in the pending table:

```
cmd> zone pending
Active zoneset [MIS_NT_CLSTR1_SAN1] contains 2 zone(s)
    zone [Web_Zone] contains 4 member(s)
        zone member = [1000000102421303]
        zone member = [2100005004d02f78]
        zone member = [210000010241ff73]
        zone member = [210000010249a7ab]
    zone [Mail_Zone] contains 4 member(s)
        zone member = [210000010241ff73]
        zone member = [210000010249a7ab]
        zone member = [100000a0c991a47a]
        zone member = [200000600819ae48]
```

Viewing the Zone Set in the pending table

To display zone sets in the pending table:

```
cmd> zone pending displayzs
Active zoneset [MIS_NT_CLSTR1_SAN1] contains 2 zone(s)
    zone = [Web_Zone]
    zone = [Mail_Zone]
```

Viewing the Zones in the pending table

To display the zones in the pending table:

```
cmd> zone pending displayzn
zone [Web_Zone] contains 4 member(s)
    zone member = [1000000102421303]
    zone member = [2100005004d02f78]
    zone member = [210000010241ff73]
    zone member = [210000010249a7ab]
zone [Mail_Zone] contains 4 member(s)
    zone member = [210000010241ff73]
    zone member = [210000010249a7ab]
    zone member = [100000a0c991a47a]
    zone member = [200000600819ae48]
```

Viewing the Zone Members in the pending table

To display the zone members in the pending table:

```
cmd> zone pending displayzm
WWPN                                     Name
1000000102421303                         [Server1]
2100005004d02f78                         [Disk1]
210000010241ff73                         [Tape1]
210000010249a7ab                         [Raid1]
100000a0c991a47a                         [Server2]
200000600819ae48                         [Disk2]
```

Stage Three: Writing the Pending Table to the Active Table

To complete your zoning configuration, write the newly created pending table to the active zone table.

```
cmd> zone write
You are about to rewrite active zone configuration with the
following pending configuration:

    Active zoneset [MIS_NT_CLSTR1_SAN1] contains 2 zone(s)
        zone [Web_Zone] contains 4 member(s)
            zone member = [1000000102421303]
            zone member = [2100005004d02f78]
            zone member = [210000010241ff73]
            zone member = [210000010249a7ab]
        zone [Mail_Zone] contains 4 member(s)
            zone member = [210000010241ff73]
            zone member = [210000010249a7ab]
            zone member = [100000a0c991a47a]
            zone member = [200000600819ae48]

Confirm write? [N] y
Zone configuration updated!
```

To display all local zone sets, zones, and zone members in the active table:

```
cmd> zone active local

Active zoneset [MIS_NT_CLSTR1_SAN1] contains 2 zone(s)
    zone [Web_Zone] contains 4 member(s)
        zone member = [1000000102421303]
        zone member = [2100005004d02f78]
        zone member = [210000010241ff73]
        zone member = [210000010249a7ab]
    zone [Mail_Zone] contains 4 member(s)
        zone member = [210000010241ff73]
        zone member = [210000010249a7ab]
        zone member = [100000a0c991a47a]
        zone member = [200000600819ae48]
```

To display the current fabric-wide zoning configuration:

```
cmd> zone active merged
Active zoneset [MIS_NT_CLSTR1_SAN1] contains 2 zone(s)
  zone [Web_Zone] contains 4 member(s)
    zone member = [1000000102421303]
    zone member = [2100005004d02f78]
    zone member = [210000010241ff73]
    zone member = [210000010249a7ab]
  zone [Mail_Zone] contains 4 member(s)
    zone member = [210000010241ff73]
    zone member = [210000010249a7ab]
    zone member = [100000a0c991a47a]
    zone member = [200000600819ae48]
```

Laser Precautions and Fibre Channel Cables

Laser Precautions



WARNING: To reduce the risk of injury from laser radiation or damage to the equipment, observe the following precautions:

- **Allow only Compaq Authorized Service Technicians to repair the equipment.**
- **Do not open any panels, operate controls, make adjustments, or perform procedures to a laser device other than those specified herein.**
- **Do not stare into laser beam when panels are open.**

SFP and Fibre Channel Cable Connector Cleaning Considerations

Optics are susceptible to anything that hinders light transmission. Consequently, manufacturers of both 2-Gb Small Form Factor Pluggable Transceiver modules (SFP) and Fibre Channel Cable Connectors provide dust covers to protect the optical areas and ensure optical signal integrity for initial system configuration. If the fiber optic interconnects are disengaged, the optical tips can be soiled by human touch, damaged from dropping, or simply collect dust debris when exposed to the open air for extended time periods. A contaminated optic tip may not be visible to the naked eye and could potentially degrade performance of your system.

To minimize the risk of optic contamination on your system, keep the following fibre optic handling guidelines in mind:

- **Dust Covers:** Dust Covers are provided with all optical components and should be kept in place when not used. Do not throw away the dust covers after initial installation. You may need them to protect optical interconnect areas if reconfiguration is required.
- **When to Clean:** The best rule of thumb for cleaning fiber optics is common sense. If you have handled fiber optic interconnects and think there may be contamination, clean it. If you need to use a fiber optic interconnect component that is found without the dust covers in place, clean it.
- **How to Clean:** First, wipe the optics with a lint-free tissue soaked in 100 percent Isopropyl alcohol. Next, wipe optics with a dry lint-free tissue and dry with compressed/canned air.

Fibre Channel Cable

The MSA Fabric Switch 6 is intended primarily for use with Shortwave SFPs and multi-mode Fibre Channel cables. While Longwave SFPs can be used with 9 um single-mode Fibre Channel cables, performance may not be optimal due to transmission latencies.

SW-SFPs and Multi-mode Fibre Channel cables are capable of supporting distances of 2 meters to 500 meters. These cables are for use with Shortwave SFPs only. However, three multi-mode Fibre Channel cable option kits are available from Compaq if longer lengths are desired. Each kit contains a multi-mode Fibre Channel cable with a connector attached to each end. The Modular SAN Array 1000 storage systems and associated host bus adapters ship standard with 2m and 5m Fibre Channel cables, respectively. Other available kits are:

- 15-meter multi-mode Fibre Channel Cable option kit (part number 234457-B23)
- 30-meter multi-mode Fibre Channel Cable option kit (part number 234457-B24)
- 50-meter multi-mode Fibre Channel Cable option kit (part number 234457-B25)

To customize your system with multi-mode Fibre Channel cable at distances greater than 50 meters, contact an independent Fibre Channel cable supplier.

If you are using an existing 62.5-micron cable in your infrastructure, you must obtain a 62.5-micron jumper from an independent source. A 50-micron cable cannot be spliced with a 62.5-micron cable.



CAUTION: Make certain the Fibre Channel cables are installed and supported so that no excess weight is placed on the Fibre Channel connectors. This is necessary to prevent damage to the connector and cable and to prevent a cable bend radius less than 3 inches (7.62 cm) at the connector and along the cable length. Excess Fibre Channel cable should be coiled and tied out of the way, being careful not to coil the cable in a tight loop with a bend radius of less than 3 inches (7.62 cm).

Updating the Fabric Switch MSA Fabric Switch 6 Management Utility

The MSA Fabric Switch 6 embedded device management program is referred to as the MSA Fabric Switch 6 Management Utility. The baseline software management capabilities for the MSA Fabric Switch 6 can be accessed several different ways. For the latest version of MSA Fabric Switch 6 Management Utility as well as additional upgrading options refer to the Compaq website: www.compaq.com/storageworks, or the *MSASW6.txt* file on the Modular SAN Array 1000 Support Software CD-ROM.

Finding the MSA Fabric Switch 6 Management Utility Version Number

The current version of the MSA Fabric Switch 6 Management Utility is displayed on the MSA Fabric Switch 6, Device Summary tab. It can also be found on the main menu of the command line interface, labeled “StorageWorks MSA Fabric Switch 6 Management Utility.” The MSA Fabric Switch 6 Management Utility contains the embedded agents used by the MSA Fabric Switch 6.

Downloading the Switch Management Utility Update

There are different methods available for updating the MSA Fabric Switch 6 Management Utility.

Updating the Switch using the Web Browser Interface

To update the switch using the web browser interface under the MSA Fabric Switch 6 Service tab, see Chapter 3, “MSA Fabric Switch 6 Management Utility.”

Use this screen to set the switch’s parameter and to start the download.

IMPORTANT: The MSA Fabric Switch 6’s IP address and other networking parameters must be properly set for the download to work.

The IP address shown for the TFTP server must be changed to the IP address running the TFTP daemon. The IP address field does not have the ability to resolve host names.

The Management Utility file name must be changed to match the name of the MSA Fabric Switch 6 Management Utility update file. The Management Utility Boot File is automatically extracted from the download file by the MSA Fabric Switch 6 once the transfer is complete. The boot file name needs to be set for a successful update.

Typically, both the timeout and retry parameters do not require resetting unless the network used is overloaded with other traffic.

With all fields completed correctly and the TFTP daemon running, click on “Download” to initiate the transfer. The MSA Fabric Switch 6 Management Utility will report the success or failure of the update.

With all parameters completed correctly and the download completed, reset the switch. The update will occur automatically following the reset.

Updating the Switch using the Command Line Interface

The MSA Fabric Switch 6 can also be updated using the command line interface. Use the `tftpdl` command to set the MSA Fabric Switch 6 TFTP parameters and to start the download process. For information about the `tftpdl` command, see Appendix C, “Command Line Interface.”

The IP address shown for the TFTP server must be changed to the IP address running the TFTP daemon. The IP address field does not have the ability to resolve host names.

The download file name must be changed to match the name of the MSA Fabric Switch 6 Management Utility update. The boot file is automatically extracted from the download file by the StorageWorks MSA Fabric Switch 6 once the transfer is complete. The boot file name needs to be set for a successful update. This will be provided along with the download file at the Compaq website:
www.compaq.com/storageworks.

Typically, both the timeout and retry parameters do not require resetting unless the network used is overloaded with other traffic.

Once the transfer is initiated, the MSA Fabric Switch 6 Management Utility package number is compared with the package already resident in the MSA Fabric Switch 6. If the MSA Fabric Switch 6 Management Utility being downloaded is newer and appears compatible, the download status will be set to “in progress” and remains so until the transfer is complete. Once the MSA Fabric Switch 6 Management Utility is updated, the system reboots itself to initialize the new MSA Fabric Switch 6 Management Utility and changes the status to “complete.”

If the MSA Fabric Switch 6 Management Utility being downloaded is older than the present or incompatible with the system, the MSA Fabric Switch 6 stops the transfer and sets the download status to “rejected due to incompatible package versions.” With all parameters completed correctly and the download completed, reset the switch. The update will occur automatically following the reset.

Updating the Switch using the Boot Menu

The MSA Fabric Switch 6 can also be updated using the Boot Menu. The Boot Menu is accessible immediately after the MSA Fabric Switch 6 is powered up or reset. The Boot Menu permits you to configure the networking parameters necessary to download new MSA Fabric Switch 6 Management Utility with TFTP even if the current utility program is not functioning. To access the Boot Menu, connect to the switch directly using a null modem cable and use a program such as HyperTerminal in Windows. The default terminal settings are 38400/8N1/No Flow Control. With the null modem connected and HyperTerminal running, reset the switch. To access the Boot Menu, you must press the **Enter** key when prompted; this occurs within the first few seconds following the reset.

The IP address shown for the TFTP server IP address (4.) must be changed to the IP address running the TFTP daemon. The IP address field does not have the ability to resolve host names.

The download file name must be changed to match the name of the MSA Fabric Switch 6 Management Utility update. The file is automatically extracted from the download file by the MSA Fabric Switch 6 once the transfer is complete.

Typically, both the timeout and retry parameters do not require resetting unless the network used is overloaded with other traffic.

With all parameters completed correctly and the download completed, choose “0” to exit the boot menu and reset the switch. The update will occur automatically following the reset.

Index

A

- AC, power cord 1-5
- accessing boot menu E-4
- ACU-XE
 - overview of 2-2
- automatic port bypass 1-3

B

- boot straps, using B-2

C

cables

- 15 meter multi-mode fibre channel D-2
- 30 meter multi-mode fibre channel D-2
- 50 meter multi-mode fibre channel D-2
- cleaning fibre channel D-1
- customizing D-2
- DB-9 serial 1-5, 2-3
- ethernet RJ-45 1-5
- fibre channel D-2
- fibre channel, troubleshooting 4-7
- SFPs 4-7
- troubleshooting 4-2

CLI

- command prompt C-3
- defined C-4
- help menu, illustrated C-4
- invoking C-3

- logout screen, illustrated C-5
- main menu C-3
- main menu, illustrated C-3
- syntax C-4

Command Line Interface (CLI)

- overview of 2-2

commands, CLI

- beacon C-1
- config C-1
- exit C-1
- fabric C-1
- factdft C-2
- help C-2
- hwcfg C-2
- log C-2
- logout C-2
- netcfg C-2
- ns C-2
- portctl C-2
- portreset C-2
- portstats C-2
- portstatus C-2
- porttpp C-2
- reset C-2
- SNMP C-2
- swctl C-2
- swstate C-2
- swstatus C-2
- temp C-2
- tftpdll C-2
- topology C-2
- traps C-2

community names
 restoring 2-10
 retrieving 2-10
 setting new 2-10
Compaq authorized reseller xi
Compaq website xi
configuration
 methods of 2-2
 overview 2-2
connecting a terminal to 2-3
connection, problems 4-6
connectors
 RJ-45 Ethernet 1-4
 RS-232 DB-9 serial port 1-4

D

DB-9 serial port
 configuration 1-4
 rear panel 1-4

E

electrostatic discharge
 precautions B-1
 preventing B-1
 storing products B-1
 transporting products B-1
 types of damage from B-1
ESD See electrostatic discharge
Ethernet
 indicators 4-5
 port 1-3

F

fabric switch, configuration 2-12
figures
 backup/restore tab 3-44
 CLI beacon on command C-6
 CLI config command C-7
 CLI fabric command C-8
 CLI factdft command C-10

CLI help command C-11
CLI help menu C-4
CLI hwcfg command C-13
CLI log dlf command C-14
CLI logout command C-15
CLI logout screen C-5
CLI main menu C-3
CLI netcfg command C-15
CLI ns command C-16
CLI portctl command C-18
CLI portctl cost command C-20
CLI portctl heartbeat command C-19
CLI portctl offline command C-18
CLI portctl public command C-19
CLI portctl speed command C-19
CLI portctl type command C-19
CLI portstats command C-21
CLI portstatus command C-22
CLI portstatus with port number
 command C-22
CLI porttp command C-23
CLI reset command C-23
CLI SNMP command C-24
CLI SNMP con command C-25
CLI SNMP loc command C-25
CLI SNMP name command C-24
CLI supported commands C-12
CLI swstate command C-26
CLI swstate command ports data C-27
CLI swstatus command C-27
CLI temp command C-28
CLI tftpd command C-30
CLI topology command C-32
CLI traps add command C-35
CLI traps command C-35
CLI traps delete command C-36
CLI traps filter command C-36
CLI traps state command C-36
console screen 3-4
device view 3-48
device view screen 3-12
error statistics view screen 3-27
events tab 3-46

- firmware tab 3-42
- login menu 2-5
- main help session screen 3-14
- main session screen 3-13
- management options menu 2-10
- MSA fabric switch 6 1-2
- MSA1000 with a Fabric Switch 6
 - installed 1-4
- network parameters menu 2-6
- network tab 3-39
- port button screen 3-16
- port events tab screen 3-19
- port info/port control tab screen 3-20
- port info/reset view screen 3-21
- port information screen 3-10
- port statistics tab 3-26
- port summary tab screen 3-17
- service tab 3-41
- set IP address menu 2-7
- set Subnet Mask menu 2-8
- SFP tab operational display screen 3-30
- SFP tab transmitter display screen 3-28
- SFP tab transmitter display screen,
 - second part 3-29
- SFP tab vendor display screen 3-30
- SFP tab vendor display screen, second
 - part 3-30
- SNMP screen 3-3
- stat counter reset view screen 3-27
- status panel screen 3-5
- switch control tab 3-36
- switch health tab 3-32
- switch info tab 3-34
- system information panel 3-31
- system information screen 3-11
- task selection toolbar 3-5
- full duplex communications 1-3

G

- gateway address
 - MSA Fabric Switch 6 configuration 2-9
 - setting 2-9
- grounding
 - methods B-2
 - straps
 - specifications B-2
 - wearing B-2

H

- heel straps, using B-2
- help
 - CLI C-4
 - command line interface C-4
- help resources x

I

- illustrations
 - backup/restore tab 3-44
 - CLI beacon on command C-6
 - CLI config command C-7
 - CLI fabric command C-8
 - CLI factdft command C-10
 - CLI help command C-11
 - CLI help menu C-4
 - CLI hwcfg command C-13
 - CLI log dlf command C-14
 - CLI logout command C-15
 - CLI logout screen C-5
 - CLI main menu C-3
 - CLI netcfg command C-15
 - CLI ns command C-16
 - CLI portctl command C-18
 - CLI portctl command ports data C-27
 - CLI portctl cost command C-20
 - CLI portctl heartbeat command C-19
 - CLI portctl offline command C-18
 - CLI portctl public command C-19
 - CLI portctl speed command C-19

- CLI portctl type command C-19
- CLI portstats command C-21
- CLI portstatus command C-22
- CLI portstatus with port number command C-22
- CLI porttp command C-23
- CLI reset command C-23
- CLI SNMP command C-24
- CLI SNMP con command C-25
- CLI SNMP loc command C-25
- CLI SNMP name command C-24
- CLI supported commands C-12
- CLI swstate command C-26
- CLI swstatus command C-27
- CLI temp command C-28
- CLI tftpd command C-30
- CLI topology command C-32
- CLI traps add command C-35
- CLI traps command C-35
- CLI traps delete command C-36
- CLI traps filter command C-36
- CLI traps state command C-36
- console screen 3-4
- device view 3-48
- device view screen 3-12
- error statistics view screen 3-27
- events tab 3-46
- firmware tab 3-42
- login menu 2-5
- main help session screen screen 3-14
- main session screen 3-13
- management options menu 2-10
- MSA fabric switch 6 1-2
- MSA1000 with a Fabric Switch 6 installed 1-4
- network parameters menu 2-6
- network tab 3-39
- port button screen 3-16
- port events tab screen 3-19
- port info/port control tab screen 3-20
- port info/reset view screen 3-21
- port information screen 3-10
- port statistics tab 3-26
- port summary tab screen 3-17
- service tab 3-41
- set IP address menu 2-7
- set Subnet Mask menu 2-8
- SFP tab operational display screen 3-30
- SFP tab transmitter display screen 3-28
- SFP tab transmitter display screen, second part 3-29
- SFP tab vendor display screen 3-30
- SFP tab vendor display screen, second part 3-30
- SNMP screen 3-3
- stat conter reset view screen 3-27
- status panel screen 3-5
- switch control tab 3-36
- switch health tab 3-32
- switch info tab 3-34
- system information panel 3-31
- system information screen 3-11
- task selection toolbar 3-5
- indicators
 - global status indicator 1-4
 - progress 3-7
 - switch status 3-6
- installation procedure, MSA Fabric Switch 6 1-5
- IP address
 - MSA Fabric Switch 6 configuration 2-7
 - setting 2-7

L

- logout screen, illustrated C-5

M

- main board, MSA Fabric Switch 6 1-3
- management options menu 2-10
- Management Utility
 - overview of 2-2
- menus
 - change password 2-11
 - gateway address 2-9
 - IP address 2-7
 - management options menu 2-10
 - network parameters 2-6
 - network parameters, illustrated 2-6
- Modular SAN Array Fabric Switch 6 See MSA Fabric Switch 6
- MSA Fabric Switch 6
 - Compaq supported SFPs 4-7
 - components 1-3
 - components of 1-4
 - configuration 1-1
 - connection problems 4-6
 - defined 1-2
 - Ethernet indicators 4-5
 - Ethernet port 1-3
 - fault indicator 4-2
 - full duplex non-blocking
 - performance 1-2
 - global status indicator 1-3
 - initialization indicator 4-2
 - main board 1-3
 - microprocessor 1-3
 - network parameters menu 2-6
 - power indicator 4-2
 - powering up 1-6
 - prerequisites 1-5
 - reading indicators 4-2
 - RS-232 serial interface port 1-3
 - serial communication problems 4-6
 - serial fibre channel cables 4-7
 - switching engine 1-3
 - temperature control problems 4-8
 - troubleshooting 4-2

- MSA Fabric Switch 6 Management Utility,
 - features 1-3
- MSA Fabric Switch 6, configuration 2-12
- multi-mode fibre channel cable D-2

N

- network
 - parameters menu, MSA Fabric Switch 6
 - configuration 2-6

P

- parameters
 - tftp E-2
- parts
 - proper handling B-1
 - storing B-1
 - transporting B-1
- passwords
 - changing 2-11
- port
 - bypass, automatic 1-3
 - RS-232 1-3
- prerequisites
 - MSA Fabric Switch 6 installation 1-5
- preventative maintenance solutions 4-1

R

- RS-232
 - serial interface port 1-3
 - troubleshooting 4-6

S

- serial
 - communication problems 4-6
 - interface port 1-3
- serial port settings
 - baud rate 2-4
 - bits per second 2-4
 - data bits 2-4
 - flow control 2-4
 - parity 2-4
 - stop bits 2-4
- setting
 - community names 2-10
 - gateway address 2-9
 - IP address 2-7
 - subnet mask 2-8
- SFPs
 - cleaning D-1
 - troubleshooting 4-7
- static-safe containers
 - storing products in B-1
 - transporting products in B-1
- subnet mask
 - MSA Fabric Switch 6 configuration 2-8
 - setting 2-8
- Switch Management Utility
 - downloading update E-1
 - finding version number E-1
 - updating using CLI E-2
 - updating using the Boot menu E-4
- switch, configuration 2-12
- switching engine, MSA Fabric Switch 6 1-3
- symbols in text ix
- symbols on equipment vii
- system, preventing electrostatic damage to B-1

T

- tables
 - backup/restore tab 3-45
 - command line interface summary C-1
 - control buttons 3-8
 - default serial port settings 2-4
 - error statistics 3-25
 - Ethernet indicators 4-4
 - events window 3-47
 - factory defaults C-8
 - firmware window 3-43
 - global status indicator 4-3
 - message text line 3-7
 - network tab 3-40
 - port control panel 3-22
 - port events window 3-19
 - port link indicators 4-6
 - port statistics tab 3-24
 - port summary window 3-18
 - session configuration window 3-49
 - switch control window 3-37
 - switch health window 3-33
 - switch info window 3-35
 - switch status indicators 3-6
- technical support xi
- telephone numbers xi
- temperature problems 4-8
- terminal emulator
 - monitoring 2-3
- test based UI
 - serial vs telnet 2-3
- text conventions x
- text-based UI
 - configuration of the switch 2-3
 - logging in to 2-5
- tftp
 - changing IP address E-2
 - file name parameters E-4
 - parameters E-2
 - server IP address E-2
- tools
 - conductive field service type B-2

troubleshooting

- cabling 4-2, 4-7
- connection problems 4-6
- fibre channel cables 4-7
- first stage 4-2
- guidelines 4-1
- MSA Fabric Switch 6 4-1
- preventative maintenance 4-1
- serial communication problems 4-6
- SFPs 4-7
- temperature control problems 4-8

U

- user interfaces, listed 2-2

V

- versions, Switch Management Utility,
finding E-1

W

- warnings
 - defined 1-1, D-1
- websites
 - Compaq xi
- Windows NT
 - setting up HyperTerminal properties 2-4
- wrist straps
 - specifications B-2
 - using B-2

Z

- zoning
 - setting up with the management
utility 3-50

Free Manuals Download Website

<http://myh66.com>

<http://usermanuals.us>

<http://www.somanuals.com>

<http://www.4manuals.cc>

<http://www.manual-lib.com>

<http://www.404manual.com>

<http://www.luxmanual.com>

<http://aubethermostatmanual.com>

Golf course search by state

<http://golfingnear.com>

Email search by domain

<http://emailbydomain.com>

Auto manuals search

<http://auto.somanuals.com>

TV manuals search

<http://tv.somanuals.com>