

**SP40**

# **User Manual**

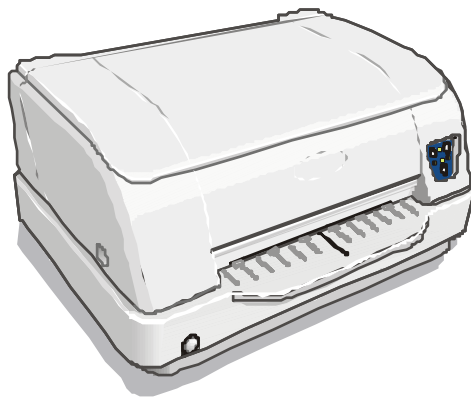

**Compuprint**

---

Rev. 001

## Compuprint Products Information

*Thanks for choosing the Compuprint SP40 printer.*

*Your printer is a reliable working equipment that will be very useful in your daily job.*

*Our printers have been designed to be compact and respectful of the work environment. They offer a wide range of features and multiple functions that confirm the high technological level reached by the CPG printers with Compuprint brand.*

*To maintain these printing performances unchanged in the long run, CPG International has developed specific Compuprint branded consumables for each printer type (for example: ribbon cartridges for dot matrix printers, toner and OPC cartridges for laser printers, bubble ink jet cartridges for inkjet printers) that assure an excellent operation with high printing quality level reliability.*

*CPG International recommends to use only its original Compuprint branded consumables with original packaging (identified by its holographic label). In this way, a proper use of the printer at quality level stated in the product characteristics can be assured. All typical usage problems related to not certified consumables may be avoided, such as an overall quality print level degradation and, often, the reduction of the product life due to the fact that the proper working conditions for the print heads, OPC cartridge and other printer parts are not assured.*

*Moreover, CPG does not only certify its consumables in terms of working conditions but also carefully controls their compliance with the international standard rules concerning:*

- *no cancerous materials;*
- *no flammability of the plastic materials;*
- *other standards*

*CPG advises the customers not to use products for which the compliance to this safety rules are not warranted. Finally seek your dealer or contact a CPG office and be sure that are provided you the original Compuprint branded consumables.*

## **FCC Notes**

This equipment has been tested and found to comply with the limits for a Class B digital device, pursuant to Part 15 of the FCC Rules. These limits are designed to provide reasonable protection against harmful interference when the equipment is operated in a commercial environment. This equipment generates, uses and can radiate radio frequency energy and, if not installed and used in accordance with the instruction manual, may cause harmful interference to radio communications. However, there is no guarantee that interference will not occur in a particular installation. If this equipment does cause harmful interference to radio or television reception, which can be determined by turning the equipment off and on, the user is encouraged to try to correct the interference by one or more of the following measures:

- Reorient or relocate the receiving antenna.
- Increase the separation between the equipment and the receiver.
- Connect the equipment into an outlet on a circuit different from that to which the receiver is connected
- Consult the dealer or an experienced radio/TV technician for help.

A shielded Centronics IEEE1284 compliant bi-directional parallel cable, maximum length 3 meters (10 feet), and a shielded RS-232 serial cable, maximum length 15 meters (50 feet), are necessary for this device to meet the requirements of a Class B digital device pursuant to part 15 of the FCC rules.

The above specified cables are readily available as Personal Computer or Peripheral accessories from multiple retail outlets. Please consult your dealer for details concerning such cables and also for information about FCC rules for digital devices.

Changes or modifications to the device covered by this manual, which are not expressly approved by the party responsible for compliance, could void the user's authority under the FCC rules to operate the equipment.

## **Canadian D.O.C. Radio Interference Regulation**

This digital apparatus complies with the Canadian ICES-003 Class B limits for radio frequency emissions.

Cet appareil numérique est conforme aux limites de Classe B de la norme NMB-003 du Canada.

## EEC Regulations

This equipment conforms to the EEC Directive 89/392 (the sound pressure, measured according to ISO 7779, does not exceed 70 dBA).

## Table of Contents

<b>Compuprint Products Information .....</b>	<b>ii</b>	<b>Printer Setup.....</b>	<b>23</b>
<b>FCC Notes .....</b>	<b>iii</b>	Entering the Printer Setup Mode.....	23
<b>Canadian D.O.C. Radio Interference Regulationiii</b>		Printing the Test Page .....	24
<b>EEC Regulations .....</b>	<b>iv</b>	Printing the Printer Setup Forms .....	28
<b>Table of Contents.....</b>	<b>iv</b>	Filling in the Printer Setup Forms .....	30
<b>Printer Presentation.....</b>	<b>1</b>	Setup Parameters .....	31
<b>Unpacking the Printer.....</b>	<b>3</b>	Offset Adjustments .....	43
<b>Printer Parts .....</b>	<b>4</b>	Reading the Preprinted Forms .....	47
Front View.....	4	Printer Setup Overview.....	48
Inside View .....	5	<b>Troubleshooting.....</b>	<b>49</b>
Rear View.....	6	Paper Problems.....	49
<b>Printer Installation.....</b>	<b>7</b>	Paper Jam.....	49
Choosing a Suitable Location.....	7	Paper Damaged after Printing .....	51
Installing the Power Cable.....	8	Ribbon Cartridge Problems.....	52
Installing the Ribbon Cartridge.....	9	<b>Paper Specifications .....</b>	<b>53</b>
<b>Paper Handling.....</b>	<b>15</b>	Cuts Sheets.....	54
Loading Paper .....	15	Passbooks.....	55
<b>The Operator Panel.....</b>	<b>17</b>	Passbooks with Horizontal Fold .....	56
Function Keys.....	18	Passbooks with Vertical Fold.....	57
Leds .....	19	<b>Technical Specifications .....</b>	<b>58</b>
<b>Software Driver Selection.....</b>	<b>20</b>		
<b>Connection to the Host .....</b>	<b>21</b>		
Setting the Interface Parameters .....	22		
Parallel Interface.....	22		
Serial Interface .....	22		

---

# Printer Presentation

This dot-matrix printer is a multi-purpose printer for front office applications. Its compact structure is designed for integration in an ergonomic environment. The printer provides a high level of reliability, form-handling accuracy and data integrity. Its main features are:

- Printing on a **wide range of paper** media: different types of cut sheets, multi-parts and passbooks.
- High print pressure for **multi-parts documents**
- **High print quality** supplied by a 24 wire print head
- **High reliability paper handling**  
The straight paper path allows the printing on particular documents such as envelopes, multipart forms and passbooks.
- **Automatic paper thickness adjustment**  
The print head detects the paper thickness for correct printing on any type of document. This printer can print also on documents with a variable thickness, such as passbooks.
- **Easy paper handling**  
The operator places the paper on the front table and the printer loads it without any other user intervention. The paper ejection towards the front or the rear of the printer allows an easy access to the printed document.
- **Automatic document alignment** feature  
The printer checks automatically the alignment of the top margin of the document and adjusts it, if necessary. The printout is therefore performed correctly independently from the paper loading position.

- **Standard parallel and serial interface** and automatic switch-over function.
- **Easy printer setup** through an optically managed menu.
- Supported **emulations**: Epson 570, IBM Proprinter XL24E, XL24E AGM, IBM 2390+, 4722, 9068 and Olivetti PR40+, PR2, 2845.

## Unpacking the Printer

Together with the printer the following items are included in the shipment box:

**Notify any damage to your supplier.**

- Ribbon cartridge
- Power cable
- CD-ROM with the printer documentation and drivers.

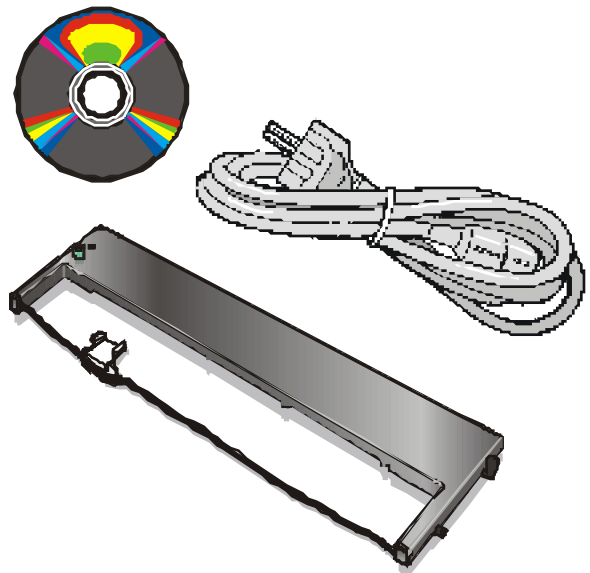

**Always keep the packing material in a safe place as you must repack the printer into it, when you need to move it.**

# Printer Parts

Never remove any printer part unless it is expressly indicated in this manual.

## Front View

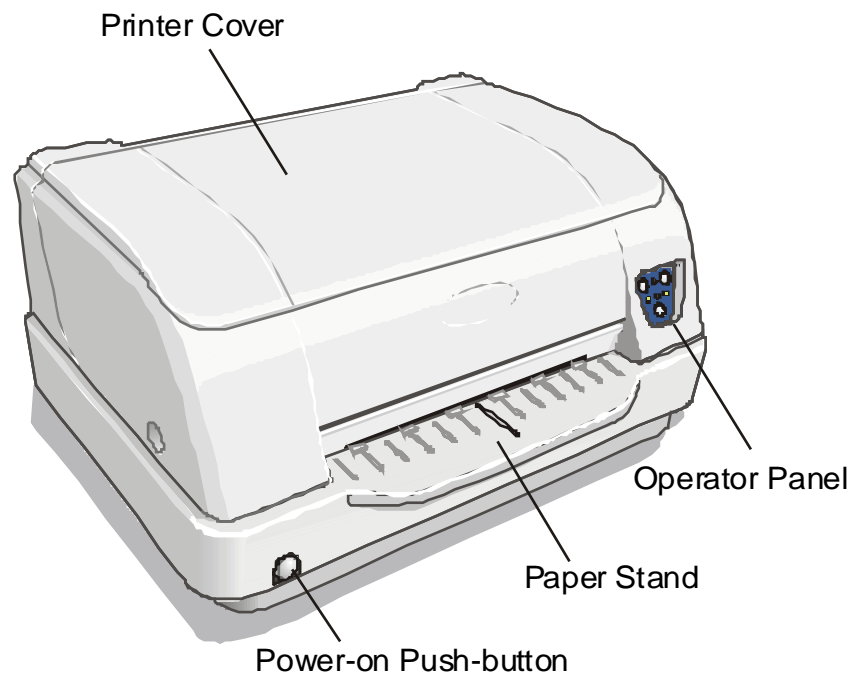



## Inside View

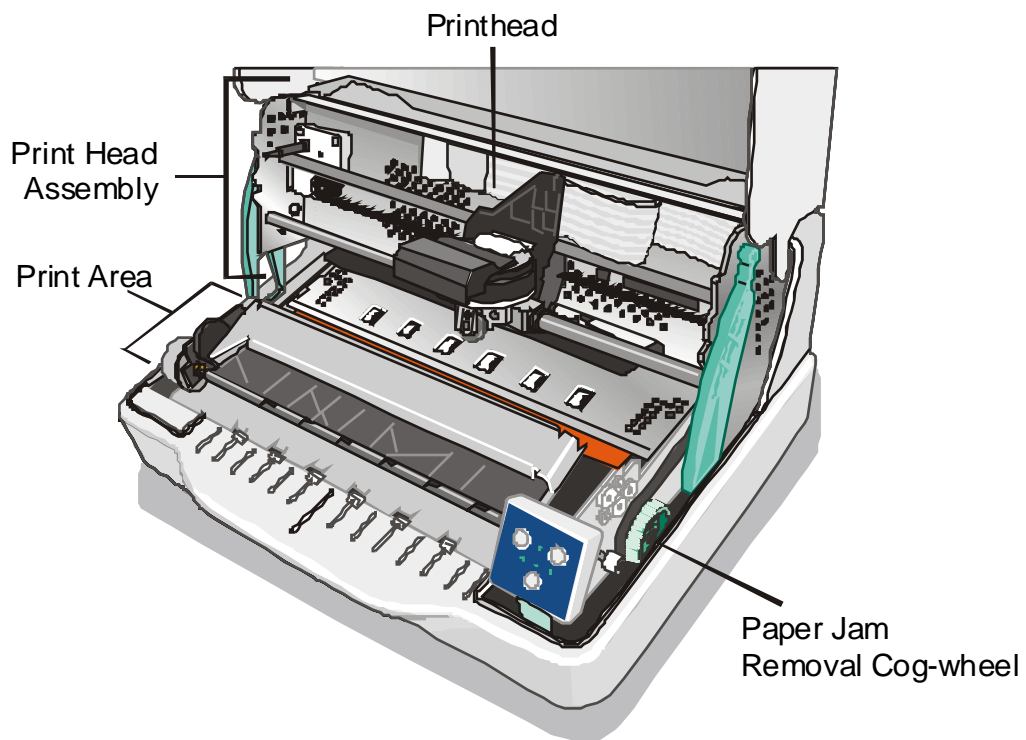

## Rear View

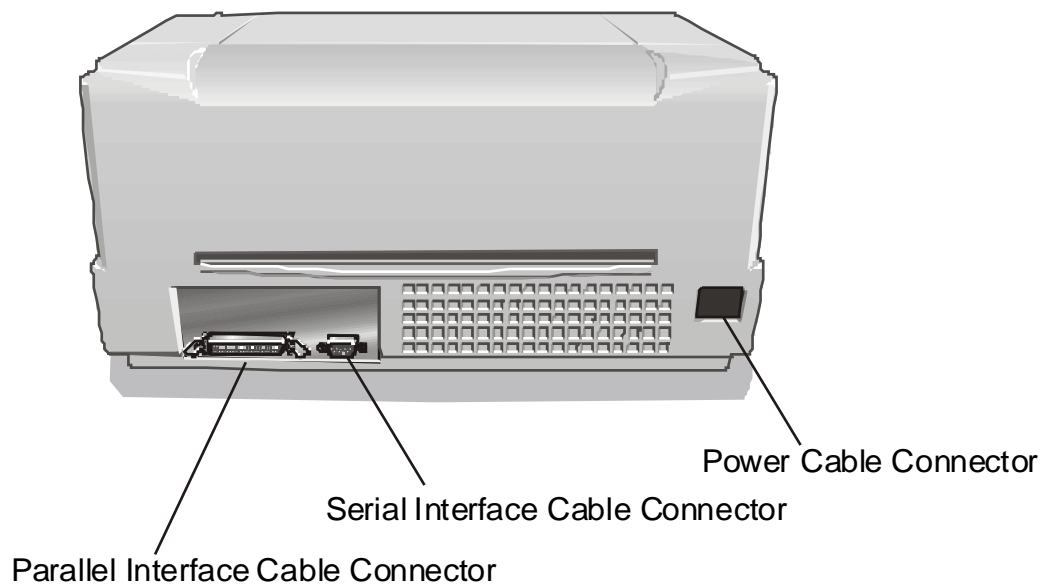

# Printer Installation

## Choosing a Suitable Location

Consider the following points when you choose the location for your printer:

- The distance between the printer and the host computer must not exceed the length of the interface cable;
- The location must be sturdy, horizontal and stable;
- Your printer must not be exposed to direct sunlight, extreme heat, cold, dust or humidity;
- When printing on standard paper formats, the paper comes out partially on the rear side of the printer. Make sure that behind the printer there is sufficient clearance to correctly move the paper.

## Installing the Power Cable

1. Find the power cable connector and the rating plate on the rear side of the printer.

**Always use a grounded outlet.**

2. Insert the power cable into the connector on the printer and the other end into a convenient mains outlet.

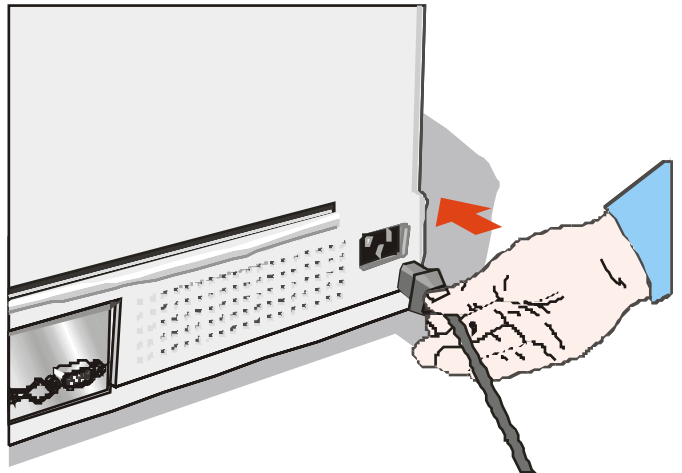

3. Press the  key on the left side of the printer front to power the printer on.

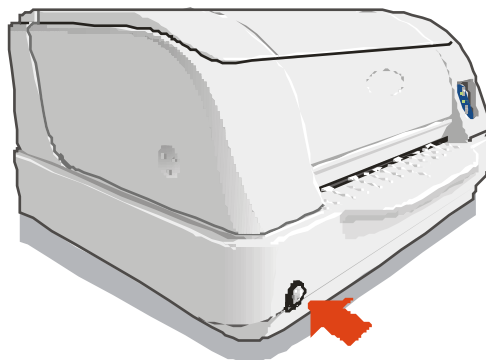

## Installing the Ribbon Cartridge

In order to avoid damaging the print head assembly, this printer accepts only original Compuprint ribbon cartridges. Therefore, if you install a not original cartridge, the printer may not work.

1. Remove the cartridge from its bag. Turn the tension knob in the direction of the arrow to tighten the ribbon.



2. Open the printer cover.

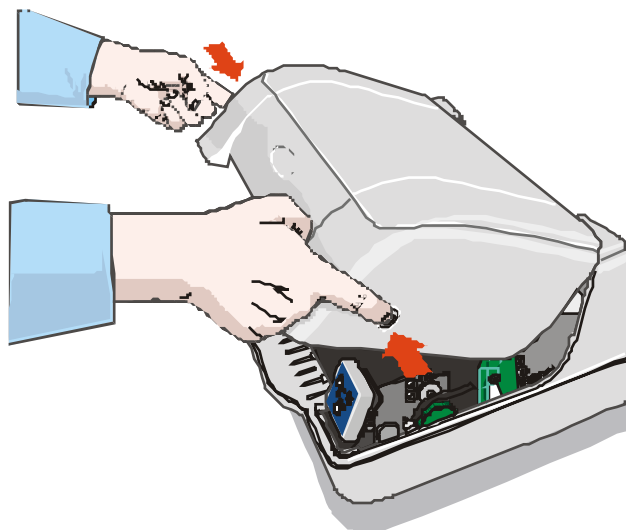

3. Open the print head assembly pushing the two green levers towards the rear of the printer. The print head assembly moves up.

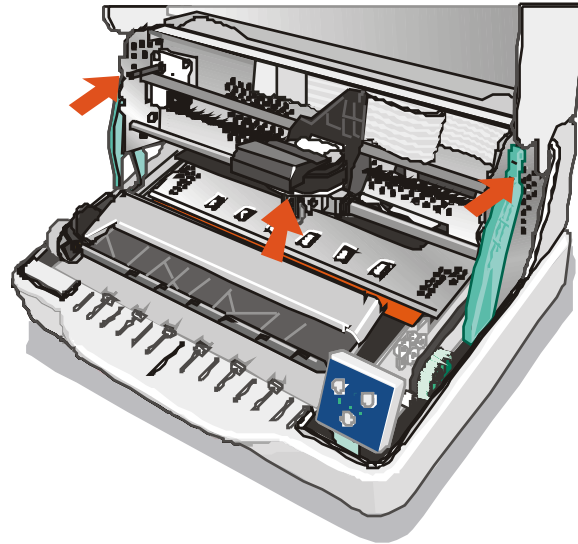

4. Move the print head to the middle of the print carriage bar.

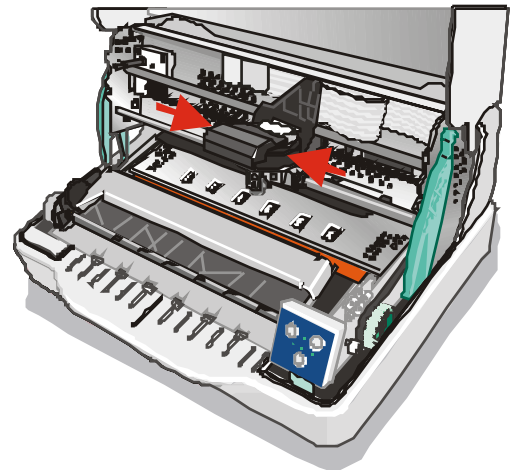

5. Insert the upper cartridge pins (1) onto the corresponding groove on the print head assembly. Then push the lower pin (2) into the corresponding lower groove until it clicks into place.

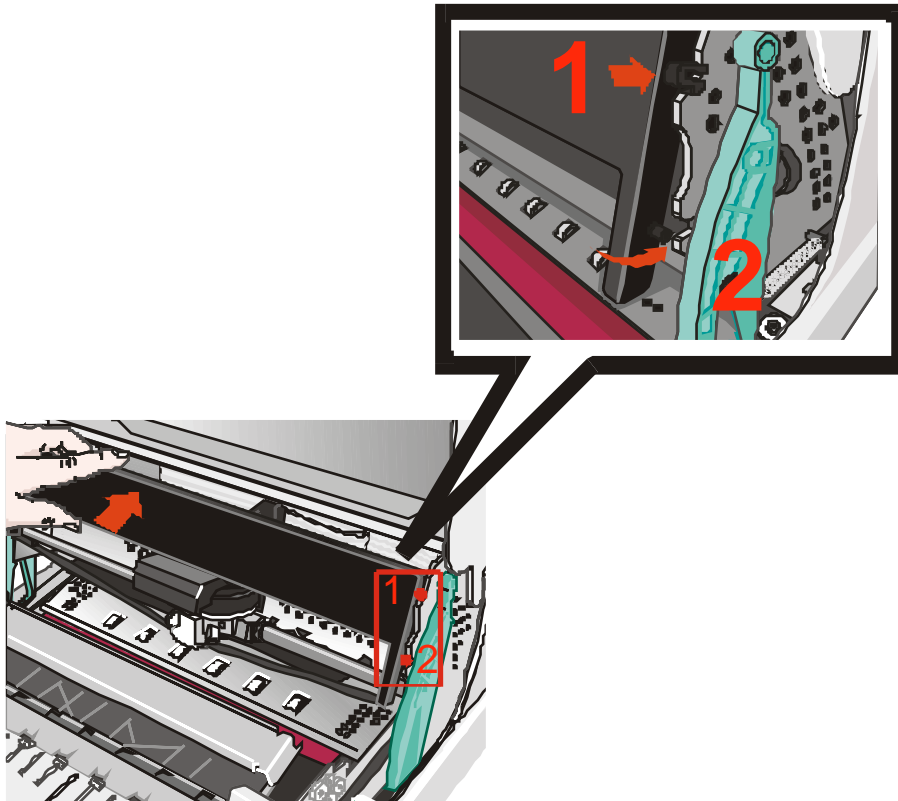



6. Insert the ribbon mask onto the print head: match the two grooves (1) on both sides of the ribbon mask with the pins (2) on both sides of the print head.

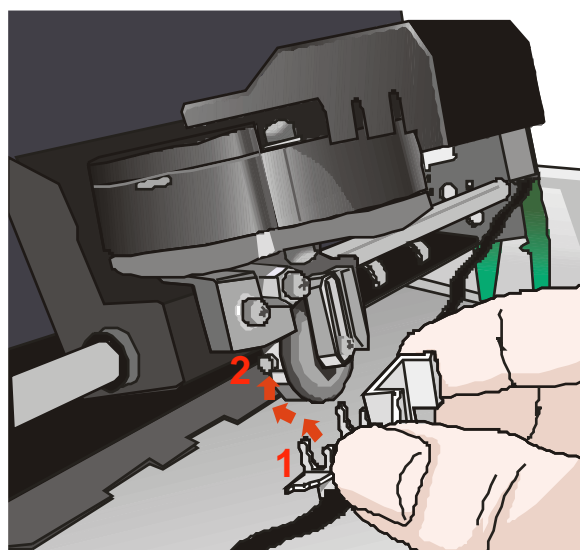

7. Push the mask up until it clicks into place.

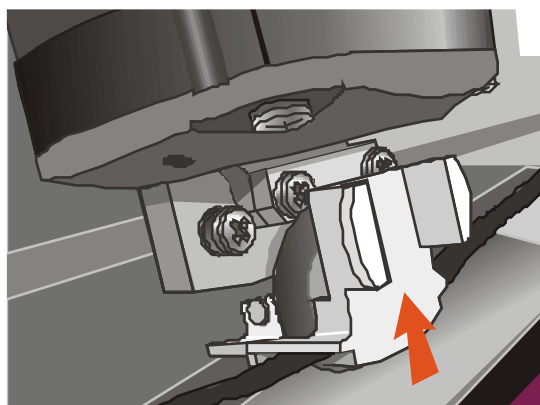

8. Turn the tension knob in the direction of the arrow to tighten the ribbon.

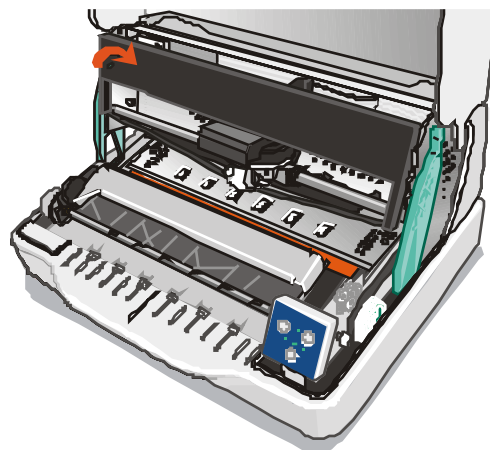

9. Push the print head assembly down, until it clicks into place.

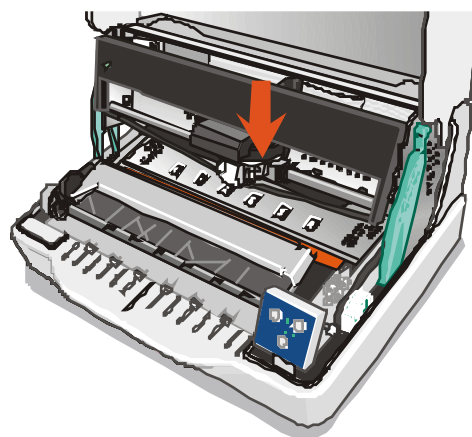

**If you do not close the print-head assembly correctly, the printer does not print and you may damage the printer cover.**

10. Close the printer cover.

## Paper Handling

This printer is designed for versatile and reliable paper handling. The flat-bed mechanism allows the *handling of special documents*, such as multiple invoices, postcards, labels, passbooks and tickets.

The print head detects the *paper edges* automatically, the sheet can therefore be inserted in any position within the detection area according to the rules described in the following paragraph.

The *paper alignment sensors* determine the alignment of the upper paper margin, adjusting it if necessary.

### Loading Paper

- The inserted documents must not have folds, tears, pins, clips, staples or any foreign material.

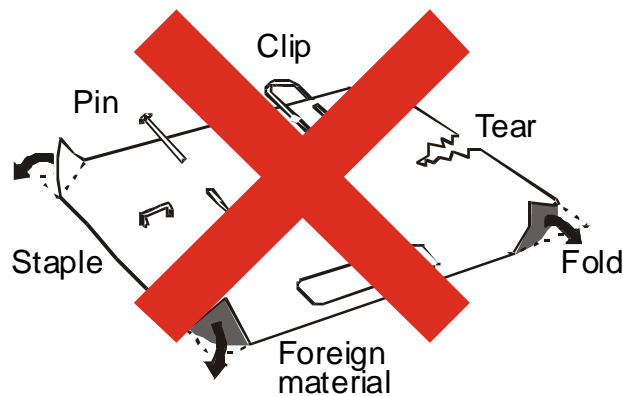

**If you insert damaged documents or paper with foreign material, you can seriously damage the printer.**

- Before inserting a passbook into the printer, open it and crease it in both directions along the binding stitch, so that the passbook lays flat on the paper stand when it is inserted into the printer.

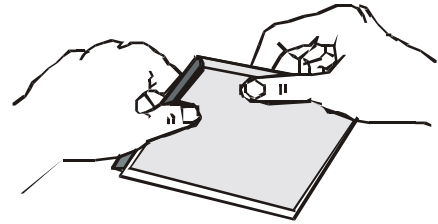
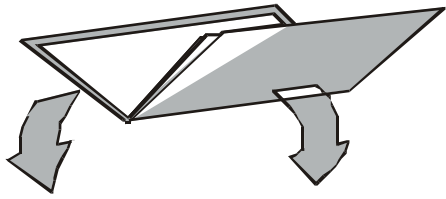

- The document may not exceed the limits of the paper stand.

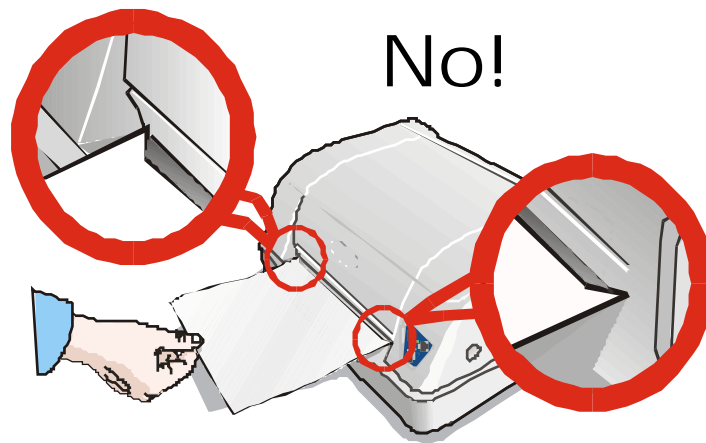

## The Operator Panel



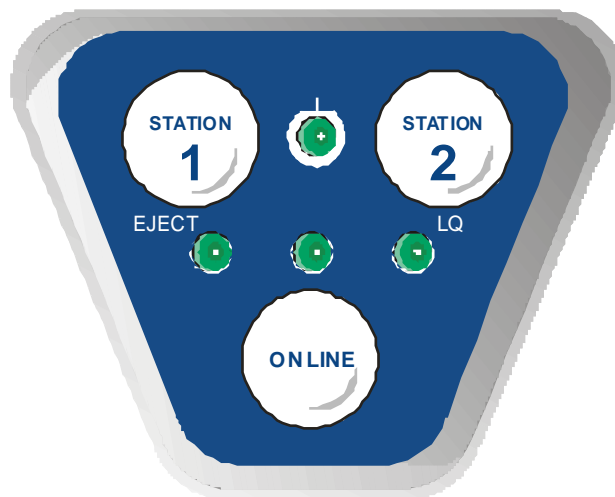

The operator panel is located on the front left side of the printer and is composed of function keys and leds with which you can easily check the printer status and select the functions as described below:



## Function Keys

STATION1	<p>Pressing this key, when the printer is offline, or when the printer is online and no print data are in the buffer, the printer ejects the paper, if inserted (EJECT function). In the Olivetti emulation, the EJECT function may be performed only if the printer is offline.</p> <p>When the Printer is in the Printer Setup mode, pressing this key the operator selects the Configuration Page to be printed. See “<a href="#">Printer Setup</a>” later in this manual.</p> <p>When using the IBM 4722, IBM 9068 and the Olivetti protocols in two operators (“booking”) mode, the application software determines the function of this key.</p>
STATION2	<p>When the printer is offline or when the printer is online and no print data are in the buffer, pressing this key, the printer toggles between Letter Quality and Draft printing mode.</p> <p>When the Printer is in the Printer Setup mode, pressing this key the Configuration Page selected with the STATION1 key will be printed. See “<a href="#">Printer Setup</a>” later in this manual.</p> <p>When using the IBM 4722, IBM 9068 and the Olivetti protocols in two operators (“booking”) mode, the application software determines the function of this key.</p>
ON LINE	<p>Toggles the printer between online and offline status.</p> <p>When pressed while powering the printer on, selects the Printer Setup Mode. See “<a href="#">Printer Setup</a>” later in this manual.</p> <p>If pressed in the Printer Setup mode, the printer prints the Self Test Page. See “<a href="#">Printing the Self Test</a>” later in this manual.</p>

## Leds

	<p>On, if the printer is powered on. Off, if the printer is powered off.</p>
	<p>Lit, when the printer is on line. Unlit, when the printer is off line. Blinks, when data are present in the printer buffer and the printer is not ready (offline or paper out condition).  If the printer is in Setup Mode, this led indicates which setup page is selected for printing. See “<a href="#">Printer Setup</a>” later in this manual.</p>
	<p>When using the IBM 4722, IBM 9068 and the Olivetti protocols in two operators (“booking”) mode, the STATION 1 led is under software control. If the printer is in Setup Mode, this led indicates which setup page is selected for printing. See “<a href="#">Printer Setup</a>” later in this manual. Blinks, together with the other operator panel leds, if a printer error occurs.</p>
	<p>Lit when the Letter Quality print mode is selected. When using the IBM 4722, IBM 9068 and the Olivetti protocols in two operators (“booking”) mode, the STATION 2 led is under software control. If the printer is in Setup Mode, this led indicates which setup page is selected for printing. See “<a href="#">Printer Setup</a>” later in this manual. Blinks, together with the other operator panel leds, if a printer error occurs.</p>

## Software Driver Selection

At this point it is necessary to configure your printer for your application package. The installation procedures depend upon the host environment.

Together with the printer you receive a CD-ROM containing the printer drivers for the Windows environment. This printer supports the Plug&Play facility in the Windows 95 / 98 / 2000 / NT4.0 / Millennium® environment.

If you want to install the printer in the Windows environment, insert the CD-ROM and follow the instructions given.

**The printer drivers of all Compuprint printers can be found at the Internet Address**

**<http://www.compuprint.net/>**



## Connection to the Host

This printer can be connected to the host by means of a parallel standard Centronics or bi-directional IEEE 1284 type interface or by means of the serial RS-232/C interface.

Proceed as follows:

1. Make sure that both the host and the printer are turned off.
2. With the help of the following figure identify the connector for the interface you want to connect and insert the cable firmly into it.
3. Fix the parallel interface cable by means of the corresponding hooks or the serial cable tightening the screws on either side of the connector.

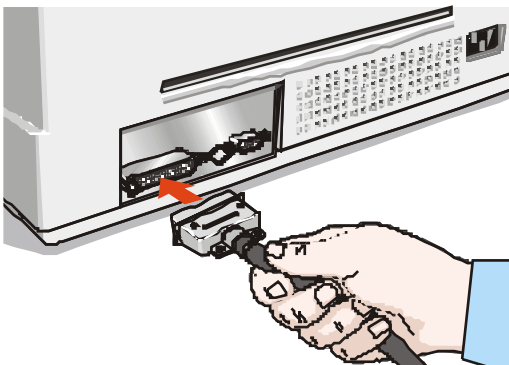

Parallel Interface (line 1)

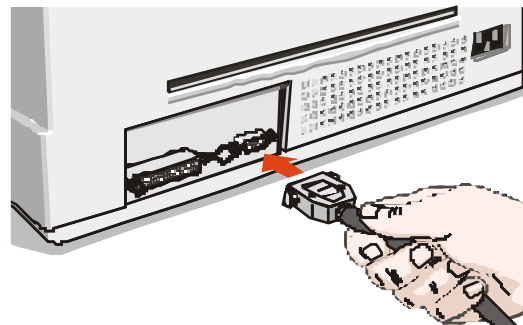

Serial Interface (line 2)

## Setting the Interface Parameters

### Parallel Interface

The parameters set for the parallel interface match most of the most common environments and the printer can be used immediately after the connection to the host.

In case you need to modify the standard parameters see “[Printer Setup](#)” later in this section.

### Serial Interface

Because of the great variety of the possible connection configurations, when you use the serial interface you will need to set the parameters accordingly.

To assure a correct functioning of the printer connected through the serial interface, the transmission parameters set for the printer must match the values set for the host.

**For a complete description of the printer setup procedure see the paragraph “[Printer Setup](#)” later in this manual.**

# Printer Setup

The Printer Setup is used to configure the printer parameters and to print a Self Test page, to check the settings and the printer installation, and to perform the Print Offset Tuning.

The default configuration of this printer matches most of the commonly used environments, but it may be necessary to change some printer parameters. With this printer you print the forms for the setup, you fill them in, and then you insert them back into the printer for reading.

Once the printer reads the form, the new values are set.

The following is the complete description of the Setup Procedure.

## Entering the Printer Setup Mode

To enter the Printer Setup Mode press and hold the **ON LINE** key pressed for at least 1 second while powering the printer on. The printer enters the Setup Mode.

The three lower leds are unlit:

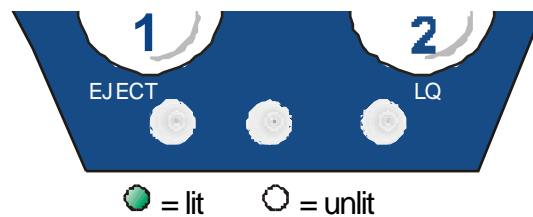

You can now:

- Print the Self Test. See “[Printing the Self Test](#)” later in this manual.

- Print one of the Printer Setup Forms (Configuration Menu or Program1/Program2 Menu) or the Offset Tuning Form. See “[Printing the Printer Setup Forms](#)” later in this manual
- Insert a filled-in Printer Setup Form to set the corresponding Setup values.

## Printing the Test Page

The Self Test page is useful to test, if the printer has been correctly installed, and allows to see the current parameter settings.

1. With the printer in the Setup Mode, insert a single sheet in A4 or Letter format.
2. The printer loads the sheet and stops.
3. Press the **ONLINE** key again.

The printer prints the Self-Test page. Check that the printout is correct. The following printout example shows the Printer Setup default values.

Once the self-test is finished, the printer remains in Setup Mode.

### SELF TEST

SP-40 : Code Version Vx.x xxxxxxxx CharGen:xxxxxxxx ver. x.xx

#### CONFIGURATION SETUP

PROGRAM	progr.1	AUTOFEED SIGNAL	disabled
ERROR BUZZER	1 beep	SLCT-IN SIGNAL	disabled
JOB BUZZER	no beep	IGNORE PE	enabled
SECURITY MODE	enabled	BUFFER CONTROL	XON/XOFF
PASSBOOK TYPE	vertical	ROBUST XON	enabled
GET EDGE QUOTE	1/2"	WORD LENGTH	8 bit
INTERFACE TYPE	automatic	BAUD RATE	9600 bps

HONOR CTS

yes

PARITY BIT

none

INPUT BUFFER

8 Kb

PROGRAM SETUP

	PROGRAM 1	PROGRAM 2
PROTOCOL	IBM 4722	OLI.PR2
FONT	Draft	Draft
FAST LQ	No	yes
HORIZONTAL PITCH	10 lpi	10 lpi
VERTICAL PITCH	6 lpi	6 lpi
LOCK	No lock	No lock
FORM LENGTH	A4	A4
	0	0
LEFT MARGIN	0	0
RIGHT MARGIN	96	96
TOP MARGIN	0	0
BOTTOM MARGIN	0	0
IBM C-SET	IBM set 1	IBM set 1
IBM COMPRESS	17.1 cpi	17.1 cpi
EPSON C-SET	graphic	graphic
NATION C-SET	USA	USA
CODE PAGE	CP437	CP437
OLIVETTI C-SET	INTERN.	INTERN.
VERT. RESOLUTION	1/240 inch	1/240 inch
RESET WITH EJECT	yes	yes
LINE MODE	LF=LF, CR=CR	LF=LF, CR=CR
WRAP MODE	autowrap	autowrap
SLASHED ZERO	no	no
PRINT DIRECTION	sw control	sw control
EJECT ON FF	yes	yes
RESET WITH EJECT	yes	yes
CUT SHEET EJECT	on front	on front
PRINT IMPACT	Strong	Strong

VERT.POS 1/10"	0	0
VERT.ADJ 1/60"	0	0
HORIZ.POS 1/10"	0	0
HORIZ.ADJ 1/60"	0	0

---

## Printing the Printer Setup Forms

If you already have the preprinted forms for the printer setup, go to “**Filling in the Printer Setup Forms**” later in this manual.

1. With the printer in Setup Mode, insert a blank sheet in A4 or Letter format.
2. The printer loads the sheet and stops.
3. If you press the **STATION1** key, the three lower leds change and you can select the Setup Page you want to print as follows:

● = lit    ○ = unlit



Configuration Page



Program 1 – Setup Page



Program 2 – Setup Page



Offset Tuning Setup Page



4. Pressing the **STATION2** key, the printer prints the selected Setup Page.

The printer setup forms contain all printer parameters and the values that can be set. The current value is indicated by an asterisk (\*).

**For a detailed description of the parameters and the settings see “[Setup Parameters](#)” later in this manual.**

Each Setup form is identified by a marker in the upper left corner of the page as follows:

Configuration Setup	■
Program 1	■■
Program 2	■■■
Offset Tuning Setup	■■■■

## Filling in the Printer Setup Forms

To change the values of the parameters, fill in the marker ( ) beside the value you want to set with a black or blue ball-point pen or a fiber-pen.

**Do not use pencils.**

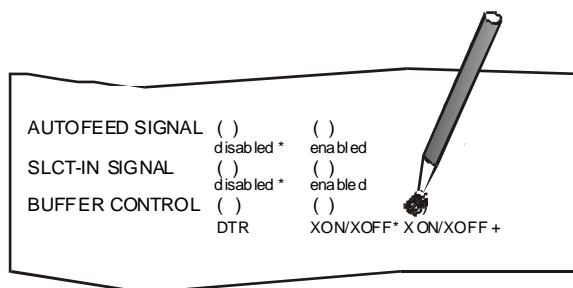

**If more than one value is set for a parameter, the printer ignores these parameters and maintains the currently set value.**

**Do not fill in the marker beside the title of the preprinted form, otherwise the printer will not be able to read that page.**

For a detailed description of the parameters and values contained in the Configuration and Program1/Program2 Menus, see “[Setup Parameters](#)” later in this manual.

For a detailed description of the Offset Tuning procedure, see “[Offset Adjustment](#)” later in this manual.

## Setup Parameters

The following is a listing of the setup parameters.

### Configuration Sheet ■

<i>Setup Parameter</i>	<i>Values</i>	<i>Description</i>
RESTORE TO MFG	no all config prog. 1, prog. 2	The selected values are not set to factory defaults. The values set in all printer setups are reset to factory default values. The values set in the configuration setup are reset to factory default values. The values set in the corresponding program setup are reset to the factory default values.
PROGRAM	prog. 1, prog. 2, on interface	Defines the default Program Setup. Selecting <code>prog. 1</code> or <code>prog. 2</code> the setup parameters set in the corresponding Program Setup are set.  Selecting <code>on interface</code> the printer matches the Program 1 settings with the data arriving on the Centronics interface, and the Program 2 settings with the data it receives from the serial interface. When changing from one interface to the other, the default values are set for the corresponding Program Setup.
ERROR BUZZER	enable, disable	Enables or disables the buzzer in case of an error.
JOB BUZZER	no beep,	Selects the behavior of the buzzer when a new print job starts: no

1 beep,  
continuous

signal (no beep), one beep (1 beep) or a continuous signal  
(continuous).

<i>Setup Parameter</i>	<i>Values</i>	<i>Description</i>
INTERFACE TYPE	parallel, serial, financial, automatic	Selects the interface type. Selecting 'automatic' the interface type is selected between serial and parallel by the printer depending on data coming from host.  The 'financial' interface should be selected for typical applications of the IBM4722 and IBM9068 protocol with the controlled link required by the IBM financial driver. When this item is set, the parallel port is disabled.
HONOR CTS	no, yes	This setting is significant only if the 'financial' interface has been selected.  Considers (yes) or ignores (no) the CTS signal received from host for the control of the data stream from host.
INPUT BUFFER	1 Kb, 8 Kb, 16 Kb, 32 Kb, 64 Kb	Selects the buffer size.  When the 'financial' interface is selected, this setting is ignored.
IGNORE PE	enabled, disabled	Selects whether the printer signals the paper empty condition (disabled) or not (enabled) on the busy line.
AUTOFEED SIGNAL	disabled, enabled	The parallel interface uses (enabled) or does not use (disabled) the AUTOFEED signal.
SLCT-IN SIGNAL	disabled, enabled	The parallel interface uses (enabled) or does not use (disabled) the SELECT-IN signal.
BUFFER CONTROL	DTR+SRTS, SRTS, XON/XOFF, ETX/ACK,	Selection of the buffer protocol. When the 'financial' interface is selected, this setting is ignored.

XON/XOFF+DTR

<i>Setup Parameter</i>	<i>Values</i>	<i>Description</i>
ROBUST XON	enabled, disabled	Perform the Robust XON (enabled) or not (disabled).
WORD LENGTH	7 bit, 8 bit	Sets the number of the data bits.  When the 'financial' interface is selected, this value is always set to 8 bits.
BAUD RATE	600 – 115200 bps	Sets the data transfer rate.
PARITY BIT	even, odd, none	Selects the parity control for the data.
SECURITY MODE	enabled, disabled	Enables or disables the security actions that assure protection against paper jams. If disabled, the paper handling is faster.
PASSBOOK TYPE	Fixed thick Vertical Horizontal	Printing on a document with fixed thickness. Printing on passbooks with upright fold. Printing on passbooks with horizontal fold.
GET EDGE QUOTE	0/2", 1/2", 2/2", 3/2", 4/2", 5/2", 6/2", 7/2"	Sets the position in which the left paper edge is checked. If set to 0, the check is performed at the first line. The other values correspond to the physical distance from the first line.

PROGRAM 1



PROGRAM 2

<i>Setup Parameter</i>	<i>Values</i>	<i>Description</i>
PROTOCOL	EPSON 570, IBM X24E, X24E AGM, IBM 2390, OLI. PR40+, OLI. PR2, OLI. PR2845, IBM 4722, IBM 9068	Defines the printer protocol. <b>NOTE:</b> For the IBM 4722 and 9068 protocols, if the software driver uses the controlled link of the IBM financial driver, set the <code>INTERFACE TYPE</code> item in the Configuration Menu to <code>financial</code> .
FONT	Draft, Courier, OCR-B, Gothic, Prestige, Present, OCR-A, Script, Boldface	Selects the font.
FAST LQ	No, Yes	Selects the fast LQ printing mode. The printer prints at 120dpi instead of 180 dpi.
HORIZONTAL PITCH	10 cpi, 12 cpi, 15 cpi, 16.6 cpi, 17.1 cpi, 20 cpi	Selects the character spacing in characters per inch (cpi).
VERTICAL PITCH	5 lpi, 6 lpi, 8 lpi	Selects the line spacing in lines per inch (lpi).
LOCK	no lock, font, hor. pitch, font+hor.pitch	The following selections made in the printer setup may be locked: font, horizontal pitch ( <code>hor.pitch</code> ), or both the font and horizontal pitch ( <code>font+hor.pitch</code> ). The locked settings cannot be changed via software commands.



Setup Parameter	Values	Description
FORMLENGTH	# lines, A4, letter, A5, legal	Sets the page length in number of lines or standard formats A4, Letter, A5 or Legal. If you select # lines, you must indicate the number of lines you want to set in the scheme below this selection. The values range between 0 and 255. To set the values combine the numbers considering that the first line corresponds to the hundreds, the second line to the tens and the third line to the units. See the example below.

*Example:*

How to set the form length to 82 lines:

FORM LENGTH	<input checked="" type="checkbox"/>	<input type="checkbox"/>	<input type="checkbox"/>	<input type="checkbox"/>	<input type="checkbox"/>	<input type="checkbox"/>	<input type="checkbox"/>	<input type="checkbox"/>	<input type="checkbox"/>	<input type="checkbox"/>
	#lines	A4	letter	A5	legal					
	0	1	2	3	4	5	6	7	8	9
100 x	<input type="checkbox"/>	<input type="checkbox"/>	<input type="checkbox"/>							
10 x	<input type="checkbox"/>	<input type="checkbox"/>	<input type="checkbox"/>	<input type="checkbox"/>	<input type="checkbox"/>	<input type="checkbox"/>	<input type="checkbox"/>	<input type="checkbox"/>	<input checked="" type="checkbox"/>	<input type="checkbox"/>
1 x	<input type="checkbox"/>	<input type="checkbox"/>	<input checked="" type="checkbox"/>	<input type="checkbox"/>	<input type="checkbox"/>	<input type="checkbox"/>	<input type="checkbox"/>	<input type="checkbox"/>	<input type="checkbox"/>	<input type="checkbox"/>

Setup Parameter	Values	Description
LEFT MARGIN	10 x 1 x	Sets the left margin in number of columns. The values range between 0 and 90. To set the values combine the numbers considering that the first line corresponds to the tens, the second line to the units. See the example below.

*Example:*

How to set the Left Margin to 20.

LEFT MARGIN										
	0	1	2	3	4	5	6	7	8	9

10 x      ( ) ( ) **■** ( ) ( ) ( ) ( ) ( ) ( ) ( )  
 1 x      **■** ( ) ( ) ( ) ( ) ( ) ( ) ( ) ( ) ( ) ( )

Setup Parameter	Values	Description
RIGHT MARGIN	100 x 10 x 1 x	Sets the right margin in number of columns. The values range between 0 and 190. The physical position of margin depends on the current character spacing. To set the values combine the numbers considering that the first line corresponds to the hundreds, the second line to the tens and the third line to the units. See the example below :

*Example:*

How to set the Right Margin to 101.

RIGHT MARGIN

	0	1	2	3	4	5	6	7	8	9
100 x	( )	<b>■</b>								
10 x	<b>■</b>	( )	( )	( )	( )	( )	( )	( )	( )	( )
1 x	( )	<b>■</b>	( )	( )	( )	( )	( )	( )	( )	( )

Setup Parameter	Values	Description
TOP MARGIN	10 x 1 x	Sets the top margin in number of lines. The values range between 0 and 90. To set the values combine the numbers considering that the first line corresponds to the tens, the second line to the units. See the example below .

*Example:*

How to set the Top Margin to 15.

TOP MARGIN

	0	1	2	3	4	5	6	7	8	9
10 x	( )	■	( )	( )	( )					
1 x	( )	( )	( )	( )	( )	■	( )	( )	( )	( )

Setup Parameter	Values	Description
BOTTOM MARGIN	10 x 1 x	Sets the bottom margin in number of lines. The values range between 0 and 90. To set the values combine the numbers considering that the first line corresponds to the tens, the second line to the units. See the example below.

*Example:*

How to set the bottom margin to 34 lines:

BOTTOM MARGIN

	0	1	2	3	4	5	6	7	8	9
10 x	( )	( )	( )	■	( )					
1 x	( )	( )	( )	( )	■	( )	( )	( )	( )	( )

Setup Parameter	Values	Description
IBM C-SET	IBMset 1, IBMset 2	Selects the IBM character set.
IBM COMPRESS	17.1 cpi, 20 cpi	Selects the pitch for the compressed mode printing in IBM emulation.
EPSON C-SET	Italic, graphic	Selects italic or graphic Epson character set.
NATION C-SET	USA, FRANCE, GERMANY, ENGLAND, DENMARK1, SWEDEN, ITALY, SPAIN1, JAPAN, NORWAY, DENMARK2, SPAIN2, LATIN A1	Selects the national character sets.

<i>Setup Parameter</i>	<i>Values</i>	<i>Description</i>
CODE PAGE	CP437, CP437G, 96GREEK, CP850, CP851, CP852, CP853, CP855, CP857, CP858, CP860, CP862, CP863, CP864, CP865, CP866, CP867, CP876, CP877, CP1098, CP1250, CP1251, CP1252, GOST, TASS, MAZOWIA, CP437SL, UKRAIN, 8859/1, 8859/2, 8859/3, 8859/4, 8859/5, 8859/6, 8859/7, 8859/8, 8859/9, 8859/15, ROMAN-8, ID 12, ID 14, ID 17, SANYO, KU, PHILIP	Selects the code page for both the IBM and the EPSON emulations.
OLIVETTI C-SET	CODE PAGE*, INTERN., GERMANY, PORTUGAL, SPAIN1, DEN/NORW, FRANCE, ITALY, SWE/FIN, SWISS, G. BRITAIN, USA ASCII, GREECE, ISRAEL, SPAIN 2, JUGOSLAVIA, TCV 370, CANADA, SDC, TURKEY, CIBC, PC-DEN/NORW, PC-DEN OPE, PC-210, PC-220, OLI-UNIX	Selects the character sets for the OLIVETTI protocol.  Selecting CODE PAGE, it is possible to select one of the above Code Pages to be used with the Olivetti protocol.
VERT. RESOLUTION	1/216 inch, 1/240 inch	Sets the vertical character resolution. Setting used for the OLIVETTI protocols.
RESET WITH EJECT	no, yes	When the printer receives a reset command, selecting <i>yes</i> it ejects the paper, selecting <i>no</i> it performs only the reset command. Setting used for the OLIVETTI protocols.

<i>Setup Parameter</i>	<i>Values</i>	<i>Description</i>
LINE MODE	LF=LF, CR=CR	If the printer receives a LF code (LF), it only performs a line feed. If the printer receives a CR code (CR), it only performs a carriage return.
	CR=LF+CR	If the printer receives a CR code (CR), it performs a carriage return followed by a line feed. If the printer receives a LF code (LF), it performs a line feed.
	LF=LF+CR	If the printer receives a LF code (LF), it performs a line feed followed by a carriage return. If the printer receives a CR code (CR), it only performs a carriage return.
	LF&CR=LF+CR	If the printer receives a LF code (LF) or a CR code (CR), it performs both a line feed and a carriage return.
WRAP MODE	truncate, autowrap	The data exceeding the line length are truncated ( <i>truncate</i> ) or printed on the following line ( <i>autowrap</i> ).
SLASHED ZERO	no, yes	Selects the printing character for zero, with a slash ( <i>yes</i> ) or without ( <i>no</i> ).
PRINT DIRECTION	unidir., bidir., sw control	Selects the printing direction of the print head: unidirectional ( <i>unidir.</i> ), bidirectional ( <i>bidir.</i> ) or selected via software ( <i>sw control</i> ).
EJECT ON FF	no, yes	Performs a form feed according to the selected page format ( <i>no</i> ) or ejects a cut sheet loaded into the printer ( <i>yes</i> ).
RESET WITH EJECT	no, yes	When the printer receives a reset command, if this item is set to <i>yes</i> the paper inserted in the printer is ejected. If the item is set to

no the printer performs only the reset command.

<i>Setup Parameter</i>	<i>Values</i>	<i>Description</i>
CUT SHEET EJECT	on front, on rear	Selects whether the cut sheet loaded into the printer is ejected towards the front or the rear of the printer.
PRINT IMPACT	soft, strong	Selects the impact strength of the print head needles.

## Offset Adjustments

For a precise adjustment of the position of the printed characters on a preprinted form, the printer allows to easily adjust the first line and the first printing column as follows:

1. When the printer is in Setup Mode, press the **STATION1** key until the leds are lit in the following configuration:



2. Insert a blank sheet into the printer. The following sheet will be printed:

---

■ ■ ■ OFFSET TUNING SETUP

Vertical Position Offset (1/10 INCH)

PROGRAM 1	( )*	( )	( )	( )	( )	( )	( )	( )	( )	( )	( )	( )
PROGRAM 2	( )*	( )	( )	( )	( )	( )	( )	( )	( )	( )	( )	( )
	0	+1	+2	+3	+4	+5	+6	+7	+8	+9		

Vertical Offset Tuning (1/60 INCH)

	X	X	X	X	X	X	X	X	X	X	X	X	X
PROGRAM 1	( )	( )	( )	( )	( )	( )	( )*	( )	( )	( )	( )	( )	( )
PROGRAM 2	( )	( )	( )	( )	( )	( )	( )*	( )	( )	( )	( )	( )	( )
	-6	-5	-4	-3	-2	-1	0	+1	+2	+3	+4	+5	+6

Horizontal Position Offset (1/10 INCH)

PROGRAM 1	( )	( )	( )	( )	( )	( )	( )*	( )	( )	( )	( )	( )	( )	( )	( )	( )	( )
PROGRAM 2	( )	( )	( )	( )	( )	( )	( )*	( )	( )	( )	( )	( )	( )	( )	( )	( )	( )
	-6	-5	-4	-3	-2	-1	0	+1	+2	+3	+4	+5	+6	+7	+8	+9	

Horizontal Offset Tuning (1/60 INCH)

	PROGRAM 1	PROGRAM 2	
X	( )	( )	-6
X	( )	( )	-5
X	( )	( )	-4
X	( )	( )	-3
X	( )	( )	-2
X	( )	( )	-1
X	( ) *	( ) *	0
X	( )	( )	+1
X	( )	( )	+2
X	( )	( )	+3
X	( )	( )	+4



X	( )	( )	+5
X	( )	( )	+6

---

The Vertical Offset Tuning values correspond to 1/60 inches and set the vertical offset of the first print line starting from the default standard position at 1 mm from the upper paper margin.

The Horizontal Offset Tuning values correspond to 1/60 inches and set the horizontal offset of the first print line starting from the default standard position at 3 mm from the left paper margin.

If you need to change the default position of the first print line the vertical offset can be set in the Vertical Position Offset lines and/or the horizontal offset in the Vertical Position Offset lines. Both these values correspond to 1/10 inch values.

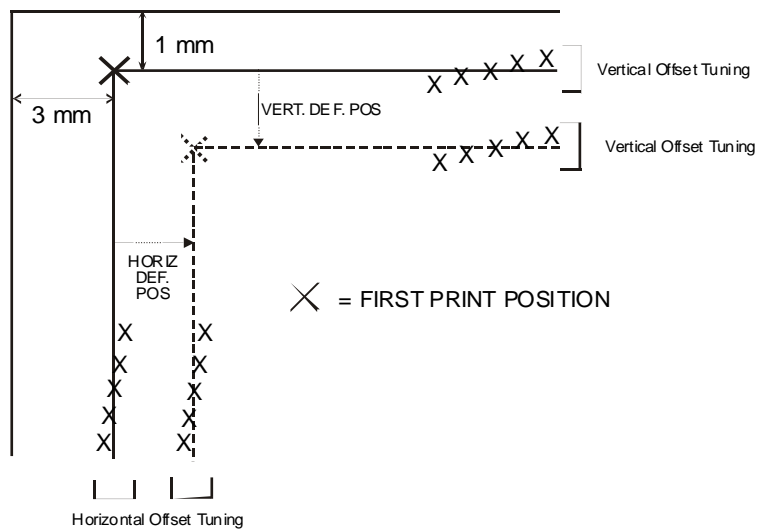

3. Fill in the marker corresponding to the value you want to set.

## Reading the Preprinted Forms

When the Printer Setup Forms have been filled in, insert them back into the printer, when the printer is in Setup Mode.

The printer is able to recognize the Setup Forms by means of the markers on these pages. The printer reads the values marked for the various parameters and configures the printer accordingly.

The settings are confirmed by a # symbol printed on the left of the corresponding marker.

The following page shows the printer setup flow-chart.

For further details concerning the parameters that can be set in the Configuration Setup, Program 1 and Program 2, see [“Setup Parameters”](#) before in this manual.

For further details on how to adjust the offset with this printer, see [“Offset Adjustments”](#) before in this manual.

# Printer Setup Overview

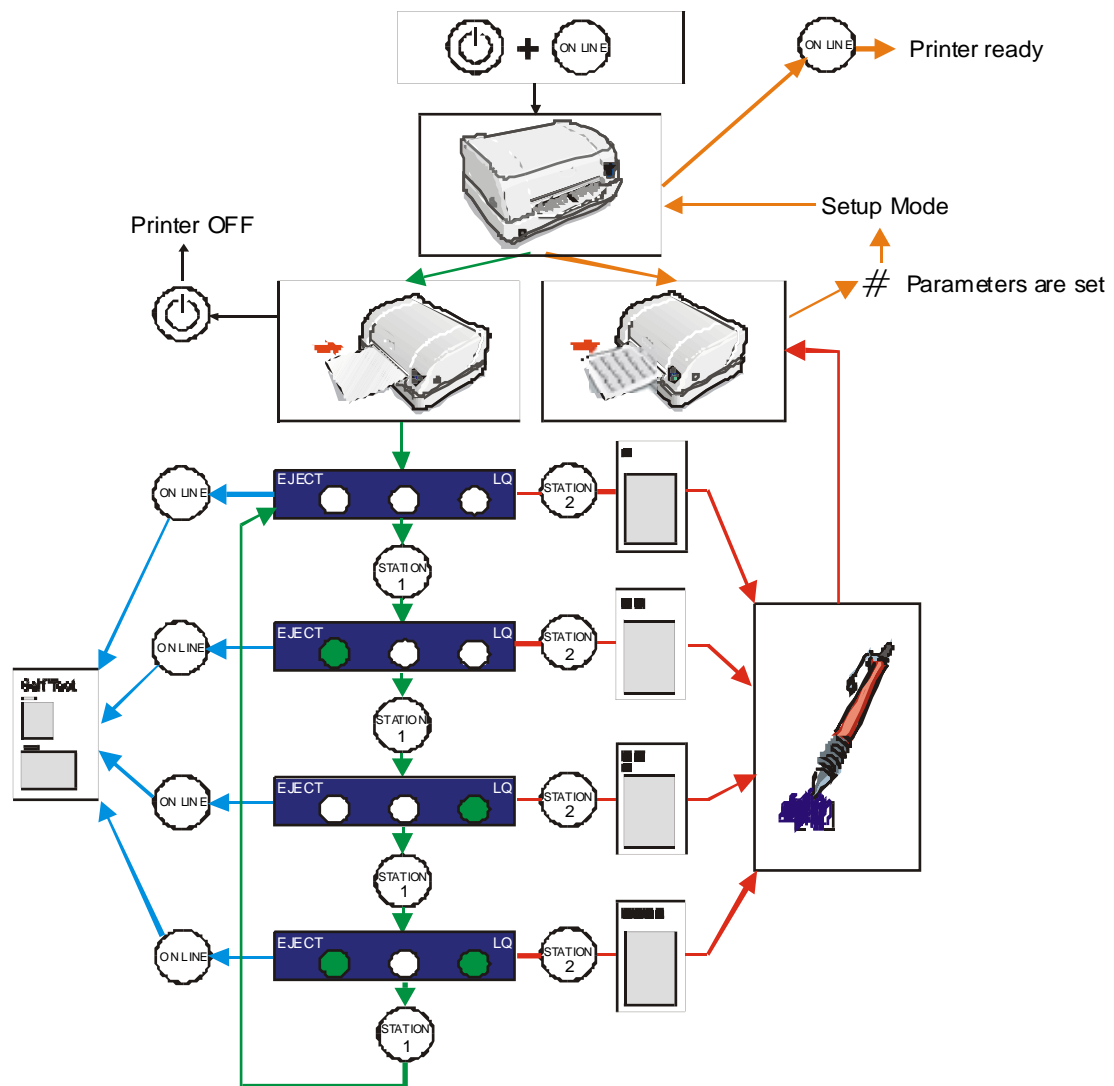

# Troubleshooting

## Paper Problems

The straight paper path of this printer is designed for trouble-free handling of a great variety of documents.

### Paper Jam

In case a paper jam condition occurs, proceed as follows:

1. Open the printer cover.
2. Open the print-head assembly pushing the green levers towards the rear of the printer. The print-head assembly moves up.

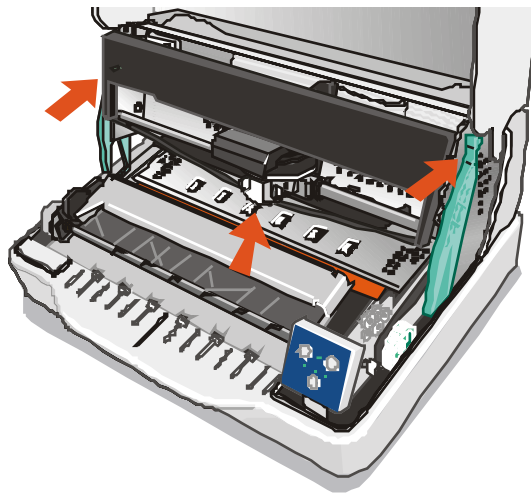

3. Remove the jammed paper, pulling it towards the front of the printer.

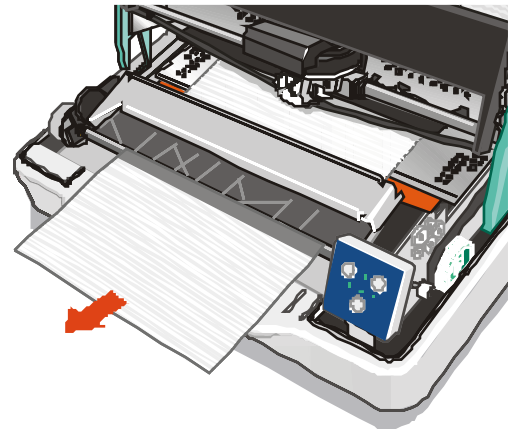

4. In case it is not possible to remove the jammed paper because you cannot reach it with your hand or it is embedded so that you cannot move it, rotate the cog-wheel beside the paper path lever to free the paper.

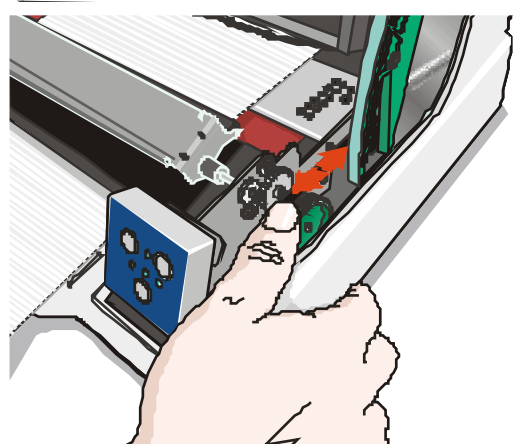

5. Push the print head assembly down, until it clicks into place.

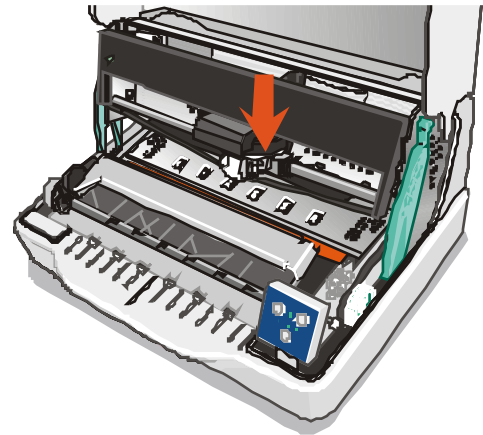

**If you do not close the print-head assembly correctly, the printer does not print and you may damage the printer cover.**

6. Close the printer cover.

## Paper Damaged after Printing

If the paper damaged after printing, it probably does not correspond to the specifications given in this manual or was not loaded according to the indications given.

Verify that the paper corresponds to the specifications (see [“Paper Specifications”](#) later in this manual) and has been loaded according to the indications given (see [“Paper Handling”](#) before in this manual).

## Ribbon Cartridge Problems

The following table is useful to identify and solve print quality problems.

Problem	Cause	Solution
Fading print	The ribbon is not fed	Check that the ribbon is correctly inserted (see “ <a href="#">Installing the Ribbon Cartridge</a> ”). Turn the ribbon tension knob to verify, that the ribbon is not blocked. If the problem is not solved, change the ribbon cartridge.
	The ribbon is used up or torn	Change the ribbon cartridge.
The printer does not print	The ribbon cartridge is not an original Compuprint cartridge.	The printer checks the inserted cartridge, to avoid damaging the print head assembly due to incorrect ribbon feeding. Insert an original Compuprint ribbon cartridge.



## Paper Specifications

The documents must all guarantee the following characteristics:

- Use paper matching the *indicated characteristics*.
- They must have well defined top and left *edges*, with a square *angle tolerance* of  $0.1^\circ$  on all edges.
- The paper must *not have holes, perforations, folds or tears* anywhere within the print area of the document.
- The *radius on a corner* of the form must be within 9.5 mm from the left or right edge.
- The form to be printed must not contain *foreign material*.
- Form *opacity* must be at least 75%. Forms with a lower opacity may cause feed errors.
- Never print on documents with *metallic or hard plastic fasteners or staples*, they may damage the printer. Use only *sewn* passbooks.
- To get the maximum *print contrast* you should print on white or light colored paper. You may overstrike to improve the low contrasting paper.
- It is preferable to use single and multiple documents with the *fibre* running in the insertion direction of the printing unit.
- *Recycled* paper is permitted on principle.
- It is preferable to print on multiple forms with *a narrow glue strip or top-gluing*. The gluing must not cause waving in the set of forms.

## Cuts Sheets

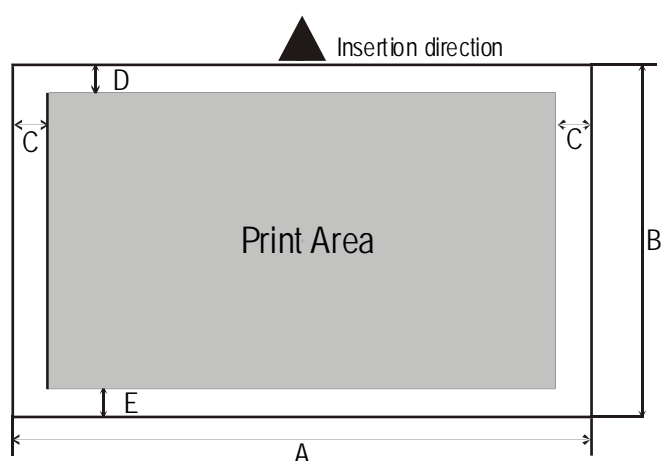

	<b>Dimensions</b>	<b>Maximum</b>	<b>Minimum</b>
A	Form width	244 mm	65 mm
B	Form length	470 mm	70 mm
C	Distance between dot position and left or right paper edge	-	3.0 mm
D	Distance between top of the first printed line and top margin of the document	-	1 mm
E	Distance between the lower margin and the lower part of the last printed line	-	6.6 mm
	Weight (original)	120 g/m <sup>2</sup>	40 g/m <sup>2</sup>
	Weight (original + 1 to 5 copies)	1 <sup>st</sup> 75 g/m <sup>2</sup> other 75 g/m <sup>2</sup> carbon 35 g/m <sup>2</sup>	1 <sup>st</sup> 55 g/m <sup>2</sup> other 45 g/m <sup>2</sup> carbon 14 g/m <sup>2</sup>
	Thickness	Form thicker than 0,35 mm may cause print quality degradation.	

## Passbooks

	Minimum	Maximum
<b>Paper Weight</b>	75	120 g/m <sup>2</sup>
<b>Thickness</b>		
Multiple Page Passbooks		
Horizontal Fold	0.28 mm (0.011 in.)	1.80 mm (0.071 in.)
Thickness difference across the fold of an open passbook		
Horizontal Fold	-	1.52 mm (0.059 in.)
Vertical Fold	-	1.52 mm (0.059 in.)
Single Page Passbook or Ledger Cards	0.18 mm (0.0071 in.)	0.28 mm (0.011 in.)
Covers	0.18 mm (0.0071 in.)	0.46 mm (0.018 in.)

- Passbooks with torn, folded, creased, incomplete or warped pages or covers should not be used.
- Printing on or across holes, edges, cut outs or folds is not permitted.
- Passbook covers must be of uniform thickness under the printing area.
- The fold of all pages and the stitching must coincide with the cover fold. The stitches should be spaced at 6 to 10 stitches per inch.
- Fiber flow on the inner sheets should be parallel to the center fold.
- The cover bulge and stitches (spine) must not exceed the following dimensions:

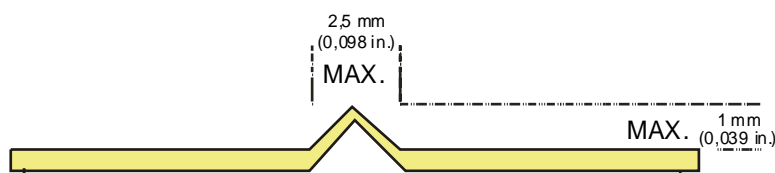

## Passbooks with Horizontal Fold

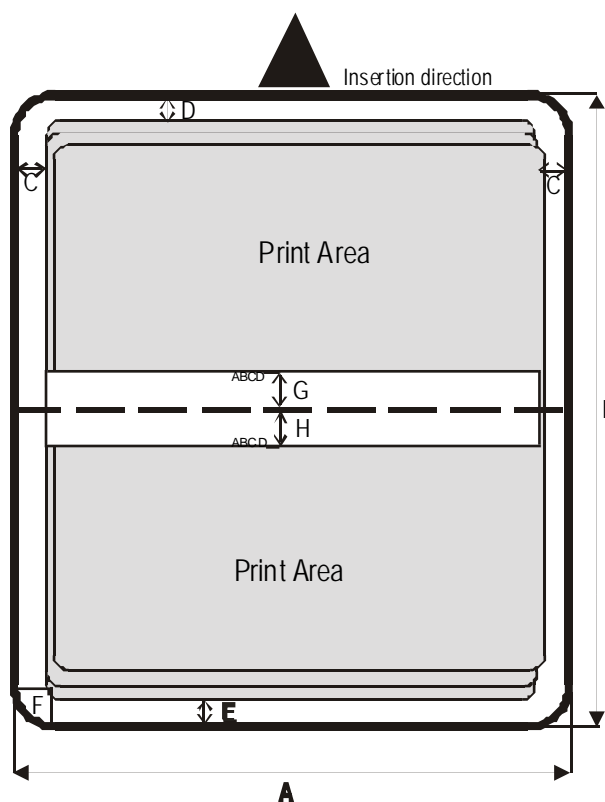

	<b>Dimension</b>	<b>Maximum</b>	<b>Minimum</b>
A	Passbook width	241 mm	110 mm
B	Passbook length	220 mm	130 mm
C	Distance between print character position and left or right edge	-	3.0 mm
D	Distance between top edge of the document and top edge of first printed line	-	1 mm
E	Distance between bottom of last printed line and bottom edge of the document	-	6.6 mm
F	Outer corner radius	9.35 mm	-
G	Distance from fold to bottom of the first printed line above the fold.	-	5.1 mm
H	Distance from fold to top of the first printed line below the fold.	-	5.1 mm

## Passbooks with Vertical Fold

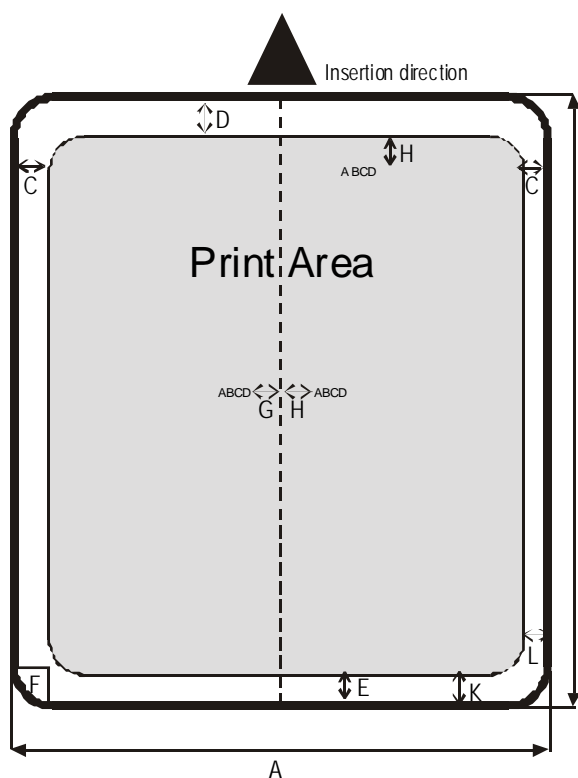

	Dimension	Maximum	Minimum
A	Passbook width	241 mm	110 mm
B	Passbook length	220 mm	85 mm
C	Distance for the dot position nearest to the left or right edge	-	3,0 mm
D	Distance from the top edge of the document to the top edge of the first printed line	-	1 mm
E	Distance from the bottom of the last printed line to the bottom edge of the document	-	6,6 mm
F	Outer corner radius	9,35 mm	-
G	Distance from the fold to the first character position beside the fold.	-	6,87 mm
H	Distance from the fold to the first character position beside the fold.	-	6,87 mm
K-L	Short Page Offset	-	0,0 mm
	Book thickness, while open	1,8 mm	0,28 mm

## Technical Specifications

### Printing Technology

Print head:	ER24S
	24 pin – Ø 0,25 mm
Print head life	400 million characters
Resolution:	360 x 360 dpi (HxV)

### Line Length (@ 10 cpi)

94 columns (cut sheets)

### Printing Speed

400 cps @ 10 cpi (Draft)

133 cps @ 10 cpi (LQ)

### Emulation

IBM® Personal Printer 2390+, Proprinter XL24E, Proprinter XL24AGM, IBM 4722, 9068, Epson 570 and Olivetti PR40+, PR2, 2845

### Resident Fonts

Draft, Courier, Gothic, Prestige, Presentor, Script, OCR-A, OCR-B, Boldface

### Character Sets (IBM and Epson protocols)

PC standard set (CS1-CS2) - 13 National Epson sets - CP437 (USA) - CP437G (Greek) - CP850 (Multilanguage) - CP851 (Greek) - CP852 (Latin 2) - CP853 (Turkish) - CP855 (Russian) - CP857 (Turkish) - CP858 (Euro) - CP860 (Portuguese) - CP862 (Hebrew) - CP863 (French/Canadian) - CP864 (Arabic) - CP865 (Norwegian) - CP866 (Cyrillic) - CP867 (Turkish) - CP876 (OCRA) - CP877 (OCRB) - CP1250 (Central Europe) - CP1251 (Cyrillic) - CP1252 (Windows Latin1 Ansi) - Gost - Tass - Mazowia - ISO 8859/1/2/3/4/5/6/7/8/9/15 - 96GREEK- Ukrainian - ID 12 - ID 14 - ID 17 - CP1098 (Farsi Arabic) - Roman-8, CP437 Slavic - Sanyo - Ku - Philip

### Character Sets (OLIVETTI protocols)

CS000 – CS010 International, CS020 Germany, CS030 Portugal, CS040 Spain1, CS050 Denmark/Norway, CS060 France, CS070 Italy, CS080 Sweden/Finland, CS090 Switzerland, CS100 Great Britain, CS110 USA ASCII, CS140 Greece, CS150 Israel, CS170 Spain 2, CS200 Yugoslavia, CS410 Olivetti TCV 370, CS510 SDC, CS520 Turkey, CS540 CIBC, CS680 OLI-UNIX, CS701 PC-220 Spain2, CS711 PC-Denmark/Norway, CS712 PC-Denmark OPE, CS771 PC-210 Greek

### Barcodes

UPC/A, UPC/E, EAN8, EAN13, Code 39, Code 128, Postnet, Codabar, ADD-ON 2, ADD-ON 5, Code 11, Code 93, BCD, MSI, 2/5 Interleaved, 2/5 Matrix, 2/5 Industrial

### Interfaces

Parallel IEEE 1284 bidirectional, nibble and byte modes

Serial RS-232/C

Automatic Interface Switching

Serial Interface Signals

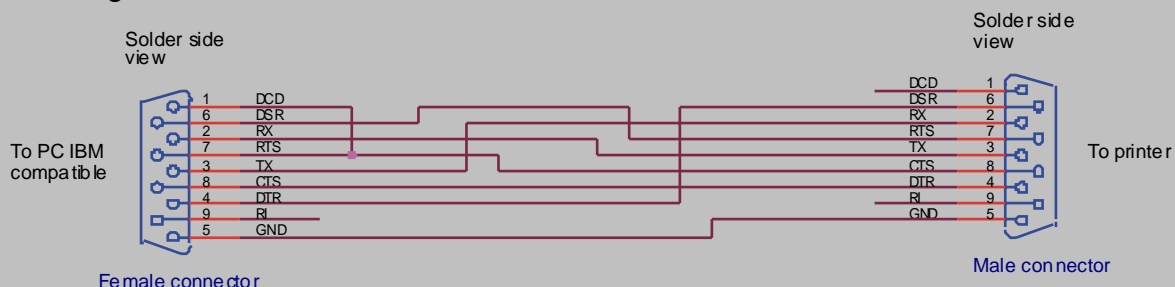

### Memory

32 Kbytes buffer

### Special Functions

Automatic Gap Adjustment (AGA)

Auto Alignment

Auto Border Recognition

**Ribbon Life**

4 million characters (black)

**Reliability**

MTBF: 10,000 hours

**Duty cycle**

28000 pages/month

**Physical Dimensions & Weight**

400 (W) x 295 (H) x 200 (D) mm

< 12 Kg

**Power Supply**

Type: Universal - auto switching

Power consumption: < 60 W (printing ISO/IEC 10561)

**Environmental conditions**

Temperature: working +10 to +40 °C

Humidity: working 40% to 60% RH (without condensation)

**Noise Level**

≤ 54dbA

**Environment**

Energy star compliant

**Compliances**

120 VAC, 60 Hz: UL 60950, CSA C22.2 No.60950, IEC 60950, FCC CFR 47 (DoC), CSA C108.8, EPA ENERGY STAR

230 VAC, 50 Hz: CE Marking, EN 60950, IEC 60950, EN 55022, EN 55024, EN 61000-3-2, EN 61000-3-3, EPA ENERGY STAR





## Free Manuals Download Website

<http://myh66.com>

<http://usermanuals.us>

<http://www.somanuals.com>

<http://www.4manuals.cc>

<http://www.manual-lib.com>

<http://www.404manual.com>

<http://www.luxmanual.com>

<http://aubethermostatmanual.com>

Golf course search by state

<http://golfingnear.com>

Email search by domain

<http://emailbydomain.com>

Auto manuals search

<http://auto.somanuals.com>

TV manuals search

<http://tv.somanuals.com>