

User Guide

Sure Cut Rotary Knife Cutter

SC-5 Servo Model

Installation

Operation

Maintenance

Troubleshooting



*Instant Access
Parts and Service
(800) 458-1960
(814) 437-6861*

www.conairnet.com

CONAIR™

The Conair Group, Inc.
One Conair Drive
Pittsburgh, PA 15202
Phone: (412) 312-6000
Fax: (412)-312-6227

UGE059/1003

Record your equipment's model and serial number(s) and the date you received it in the spaces provided.

It is important to record the model and serial number(s) of your equipment and the date you received it in the User Guide. Our service department uses this information, along with the manual number, to provide help for the specific equipment you installed.

Keep this User Guide and all manuals, engineering prints and parts lists together for documentation of your equipment.

Date:
Document Number: UGE059/1003
Serial number(s):
Model number(s):
Power Specifications: Amps
Volts
Phase
Cycle

DISCLAIMER: The Conair Group, Inc., shall not be liable for errors contained in this User Guide or for incidental, consequential damages in connection with the furnishing, performance or use of this information. Conair makes no warranty of any kind with regard to this information, including, but not limited to the implied warranties of merchantability and fitness for a particular purpose.

TABLE OF CONTENTS

INTRODUCTION	1-1
Purpose of the User Guide	1-2
How the Guide is Organized	1-2
Your Responsibilities as a User	1-2
ATTENTION: Read this so no one gets hurt	1-3
How to Use the Lockout Device	1-5
DESCRIPTION	2-1
What is the SC-5 Sure Cut?	2-2
Typical Applications	2-4
How the SC-5 Sure Cut Works	2-5
SC-5 Sure Cut Features	2-7
Specifications	2-7
Optional Equipment	2-8
INSTALLATION	3-1
Unpacking the Boxes	3-2
Preparing for Installation	3-3
Positioning the SC-5 Sure Cut	3-4
Connecting the Main Power Source	3-6
Installing the Encoder	3-7
Installing the Cutter Blades	3-8
Mounting the Cutter Bushings	3-10
Checking Repeatability	3-12
Preparing for Testing	3-13
Testing the Installation	3-13
OPERATION	4-1
The Cutter Control Feature	4-2
Before Starting	4-3
Powering Up	4-3
Main Screen	4-5
Preset to Run	4-10
Time Preset	4-11
Cut Mode	4-18
Maintenance Area	4-19
Encoder Area	4-20
Unit of Measure	4-22
Scale Distance	4-23
Homing	4-25
Offset Example	4-26
Preventative Maintenance	4-27
Power On Time	4-28
Checking Cut Quality	4-29
Starting the SC-5 Sure Cut	4-29
Making Adjustments During Operation	4-30
Stopping the SC-5 Sure Cut	4-31

MAINTENANCE5-1

Maintenance Features	5-2
Warnings and Cautions	5-2
Maintenance Overview	5-4
Preventative Maintenance Schedule	5-4
Checking the Blades	5-6
Inspecting Cutter Bushing Screws	5-7
Checking the Closure Latch	5-7
Cleaning the Blade Tray	5-8
Lubricating the Slide Rail System	5-8
Adjusting the Proximity Switches	5-9
Checking Electrical Connections	5-10
B-Loc Installation and Removal	5-12

TROUBLESHOOTING6-1

Before Beginning	6-2
A Few Words of Caution	6-2
Identify the Cause of a Problem	6-3
Electrical Problems	6-4
Product Quality Problems	6-8
Replacing Safety and Proximity Switches	6-12
Checking the Servo Amplifier	6-12
Adjusting the Proximity Switches	6-14
Checking the Encoder	6-15
Checking the Motor/Reducer Assembly	6-17
Checking Repeatability	6-18

APPENDIX

Customer Service Information	A-1
Warranty Information	A-2
Cutter Blade Selection and Use	B-1
Cutting Tips	B-3
Calculating Blade Interruption	B-4
Conair Cutter Blades	B-6
All About Cutter Bushings	C-1
Blade and Bushing Lubrication	D-1
Operator Display Overview	E-1

PARTS/DIAGRAMS

This section has been provided for you to store spare parts lists and diagrams.

INTRODUCTION

- *Purpose of the User Guide1-2*
- *How the User Guide
is organized1-2*
- *Your Responsibilities
as a User1-2*
- *ATTENTION: Read this so
no one gets hurt1-3*
- *How to Use the
Lockout Device1-5*

PURPOSE OF THE USER GUIDE

This User Guide describes the Conair SC-5 Sure Cut Servo Knife Cutter and explains step-by-step how to install, operate, maintain and repair this equipment.

Before installing this product, please take a few moments to read the User Guide and review the diagrams and safety information in the instruction packet. You also should review manuals covering associated equipment in your system. This review won't take long, and it could save you valuable installation and operating time later.

HOW THE USER GUIDE IS ORGANIZED

Symbols have been used to help organize the User Guide and call your attention to important information regarding safe installation and operation.



Symbols within triangles warn of conditions that could be hazardous to users or could damage equipment. Read and take precautions before proceeding.



Numbers within shaded squares indicate tasks or steps to be performed by the user.



A diamond indicates the equipment's response to an action performed by the user.



An open box marks items in a checklist.



A shaded circle marks items in a list.

YOUR RESPONSIBILITY AS A USER

You must be familiar with all safety procedures concerning installation, operation and maintenance of this equipment. Responsible safety procedures include:

- Thorough review of this User Guide, paying particular attention to hazard warnings, appendices and related diagrams.
- Thorough review of the equipment itself, with careful attention to voltage sources, intended use and warning labels.
- Thorough review of instruction manuals for associated equipment.
- Step-by-step adherence to instructions outlined in this User Guide.

We design equipment with the user's safety in mind. You can avoid the potential hazards identified on this machine by following the procedures outlined below and elsewhere in the User Guide.

 **ATTENTION:**
READ THIS SO NO
ONE GETS HURT



DANGER: Sharp blades!

Most injuries caused by knife blades occur when the cutter has been turned off. Handle blades with care at all times.



- Always lock out the cutter before opening the cutting chamber.
- Always wear cut-resistant gloves when the cutting chamber is open and when handling blades.

SC-5 cutters are equipped with several safety devices to ensure safe operation. Never remove or disable these devices to sustain production. Operating without these devices can cause severe injury.

- When the knife guard is opened, the knife guard switch stops the cutter.
- Two proximity-type safety switches prevent operation unless the cutter bushings are in place.
- The STOP button activates a circuit that stops the knife. (Do not attempt to change a blade or work in the cutting chamber with out locking out the power.



WARNING: Improper installation, operation, or servicing may result in equipment damage or personal injury.

This equipment should only be installed, adjusted, and serviced by qualified technical personnel who are familiar with the construction, operation, and potential hazards of this type of machine.

All wiring, disconnects, and fuses should be installed by qualified electrical technicians in accordance with electrical codes in your region. Always maintain a safe ground. Do not operate the equipment at power levels other than what is specified on the machine serial plate.

ATTENTION: READ THIS SO NO ONE GETS HURT



WARNING: Voltage Hazard

This equipment is powered by three-phase alternating current, as specified on the machine serial tag and data plate.

A properly-sized conductive ground wire from the incoming power supply must be connected to the chassis ground terminal inside the electrical enclosure. Improper grounding can result in severe personal injury and erratic machine operation.

Always disconnect and lockout power before opening the electrical enclosure or performing non-routine procedures such as maintenance and service.

In order to protect the operator from possible harm from the rotating blade wheel, several safety features are built into this cutter. They include:

Two electric switches make a contact between the side and the clear polycarbonate sliding blade observation windows such that the windows MUST BE CLOSED in order to enable the blade wheel to spin.

- This prevents someone from opening the windows and having the blade wheel spin which can cause serious injury. Tampering with this safety feature will VOID ANY responsibility for safety.

A proximity switch is positioned on both the upstream and downstream side of the bushing holder. If there are no bushings in either side, the blade will not spin.

- This prevents someone from inserting their hands or fingers in the cutting mechanism while the blade wheel is spinning. Tampering with this feature will also VOID ANY responsibility for safety.

A safety switch is positioned on the bushing holder flip up guard to prevent operation unless fully closed.

- This prevents someone from inserting their hands or fingers in the cutting mechanism while the blade wheel is spinning. Tampering with this feature will also VOID ANY responsibility for safety.

A lockable main power disconnect is provided to prevent the possibility of hazardous electrical shock while servicing the main electrical enclosure. (See How to use the Lockout Device, in Section 1)

CAUTION: It is always recommend that the main power cord be disconnected and placed in clear view of the operator or service personnel while changing blades or servicing the cutter in any capacity.



WARNING: Electrical hazard

Before performing maintenance or repairs on this product, disconnect and lock out electrical power sources to prevent injury from unexpected energization or start-up. A lockable device has been provided to isolate this product from potentially hazardous electricity.

HOW TO USE THE LOCKOUT DEVICE

Lockout is the preferred method of isolating machines or equipment from energy sources. Your Conair product is equipped with the lockout device pictured below. To use the lockout device:

- 1 Stop or turn off the equipment.** Do not stop the cutter by turning off the disconnect. Always touch the off soft key on the interface first.
- 2 Isolate the equipment from electrical power.**
Turn the rotary disconnect switch to OFF or O position.
- 3 Secure the device with an assigned lock or tag.**
- 4 The equipment is now locked out.**

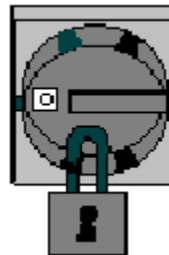
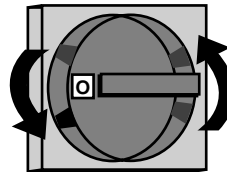

CAUTION: Moving parts

Before removing lockout devices and returning switches to the ON position, make sure that all personnel are clear of the machine, tools have been removed and all safety guards are reinstalled.

DESCRIPTION

- ***What is the SC-5 Sure Cut
Knife Cutter 2-2***
- ***Typical Applications 2-4***
- ***How the SC-5 Works 2-5***
- ***SC-5 Features 2-7***
- ***Specifications 2-7***
- ***Optional Equipment 2-8***

WHAT IS THE SC-5 SURE CUT?

The Conair SC-5 Sure Cut Series rotary knife cutter has been designed to be "The most versatile cutter of the industry".

With both capacity to cut small parts at high speeds or large tubes or profiles at low speeds this cutter can eliminate the need for moving cutters in and out of a line per application.

Today with custom profile houses potentially running 2-3 different profiles on one line in a given day, time is at a premium. Having to move different cutters in and out of line is no longer acceptable when time is money.

Mechanical Features

This series of servo rotary knife cutters use a 24 inch diameter flywheel optimizing surface speed and power. This is in fact the largest diameter wheel which could be used while still allowing it's mounting under the bushing holder.

Flywheel

With a 24 inch diameter flywheel which is 1inch thick, many benefits become available.

Planetary Gear Reducer

A 10:1 in-line servo motor rated planetary gear reducer with 7 arc-minutes maximum backlash is mounted directly to a 3000 rpm brushless servomotor. A top flywheel speed of 300 rpm is realized. Even though the flywheel appears to be moving slowly, the actual surface speed at the blade at only 300 RPM's is over 0.438 inch per millisecond. That's twice the surface speed of a typical clutch brake cutter.

Instead of mounting the cutter head directly to the servo motor shaft, which is generally not designed for high radial load or axial load due to small shaft diameters, the 24 inch flywheel is mounted to the planetary gear reducer shaft which is designed for just this type of application. At the gear ratio and output speeds which this cutter was designed, radial load on the output shaft of the reducer is in excess of 1000 lbs where the servo motor shaft may only be 100 lbs or less. Potential wear on the servo motor shaft bearings is minimized.

The high speed\low torque power of the servo motor is efficiently converted into a low RPM\high surface speed\high torque power more suitable for cutting applications.

Continued

The larger diameter flywheel used on the servo cutter offers the potential of higher surface speeds at dramatically lower blade rpm's with high cutting torque. The typical grey area between on-demand cutting and flywheel cutting (150 cpm on-demand up to 300 cpm flywheel), typically seen in DC driven clutch\brake cutter is eliminated.

It should not be necessary to cut in on demand mode in excess of 150 cuts per minute which will greatly save on premature wear to the system. Not only does this cutter offer optimum blade surface speed throughout an extremely wide cuts per minute range, but extreme accuracy throughout.

The added benefit of the 24 inch diameter by one inch thick aluminum wheel is the stored inertia which adds power for cutting larger profiles and tubes. The size of the wheel actually adds horsepower to the system. Due to the use of 10:1 gear reduction, the servomotor is made extremely efficient and easily able to handle this weight with out detrimental effects.

WHAT IS THE SC-5 SURE CUT?

CONTINUED

TYPICAL APPLICATIONS

Cutting from Below the Bushing Holder

The SC-5 Sure Cut Servo Cutter housing maximizes versatility and operational ease. Due to the size of the flywheel it was determined best to mount it directly below the bushing holder keeping the center of gravity low and offering the following benefits:

- Accessibility of the flywheel for ease of blade changes.
- Built in blade lubrication tray can be integral to the design of the cutting chamber.
- An optional blade heating system can be added to give optimum versatility to this cutter.
- With the bushing holder above the flywheel tremendous cutting capacity is available without extreme blade length.
- Ease of discharge conveyor interface for part support and automatic ejection systems is made simple with this layout.
- The optional slide system can enable the use of rigids and flexibles.

To get the full benefit from the servo cutter Conair has provided several cutting modes, *see Cutter Control, Section 4*. The Conair SC-5 Sure Cut servo rotary knife cutter is a truly innovative cutter. Loaded with features and backed up by the most extensive service support system in the industry.

HOW THE SC-5 SURE CUT WORKS

Extruded material that has been sized and cooled enters the cutter from the upstream side (*See How the SC-5 Sure Cut Works, Section 2, step 1*). Typically, a puller is placed just before the cutter; the puller pulls the extrudate through the sizing and/or cooling tanks and feeds it into the cutter.

The positional servo motor, is direct coupled to the cutter head, or an in-line planetary gear reducer that drives the cutter head. The planetary gear reducer arrangement increases cutting torque, improves servo motor efficiency, and offers improved bearing load ratings.

The cutting knife, attached to the cutter head, is driven by the servo motor (*See How the SC-5 Sure Cut Works, Section 2, step 2*). Two cutter bushings guide and support both the extrudate and the cutting knife. The cutter head is mounted directly to the in-line planetary gear reducer shaft using a B-Loc coupling device, and may have as many as four optional blade positions. *See Installation and Removal of B-Loc, Section 5*.

Two types of cutting modes are available. On-demand cutting modes (Timer, Encoder, Auto and Product) provide a single rotation cut cycle. However, in continuous cutting modes (Flywheel and Optional Follower) the cutting mechanism rotates continuously.

The knife guard includes a stainless steel lower tray, which can be used for blade lubrication. The upper knife guard includes a clear polycarbonate window. This allows you to watch the cutting blade during operation.

Cut pieces are collected or carried on to further processing by an optional conveyor (*See How the SC-5 Sure Cut Works, Section 2, step 3*).

Continued on next page.

HOW THE SC-5 SURE CUT WORKS

CONTINUED

3 Cut pieces are collected or carried away on a conveyor.

1 Extruded material enters the cutter from the upstream side.

2 The cutter head holds the blade(s) as they rotate and pass between the bushings, cutting the extrudate.



The SC-5 Sure Cut Servo Cutter features:

SC-5 FEATURES

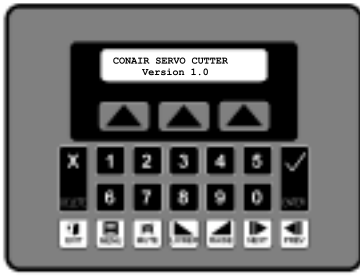

The standard control:

- Large easy-to-read display.
- Soft keys allows the operator to select different functions.
- Numeric keys permits data entry for the operator.
- Fixed function keys contain universal symbols and text.

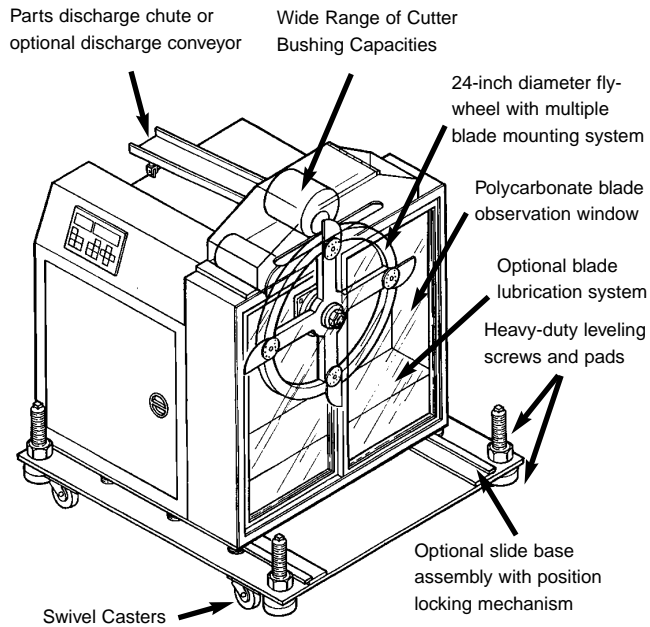

SPECIFICATIONS

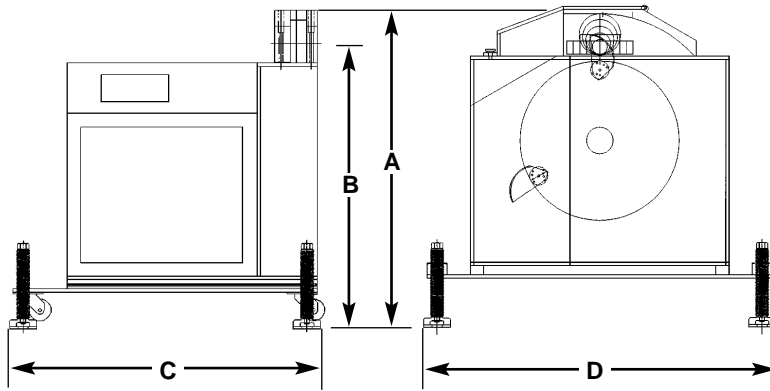

MODELS	SC-5
Performance characteristics	
Extruder capacity in. {mm}	
Tube diameters	2.25 - 5.25 {57 - 133}
Profile dimensions	2x4 - 2x10, 4x7 {51x102 - 51x254, 102x178}
Blade drive motor Hp {kW}	4.6 {3.4}
Feed direction	right>left
Dimensions in. {mm}	
A - Height	47 {1194}
B - Height to centerline	40±2 {1016±50.8}
C - Length	44 {1118}
D - Width	52 {1321}
Voltage/phase/frequency	230 V/3/60 Hz Or 460 V/3/60 Hz
Cutter control	Red Lion {CL01/FM4}

- 24-inch flywheel
- Up to 150 cuts/minute on demand with one blade
- Up to 300 cuts/minute with one blade on Flywheel mode
- Blade speeds adjustable to 300 RPM
- Surface speeds to 0.438 inches per millisecond
- Heavy-duty positional AC brushless servo drive
- 10:1 planetary gear head reducer
- 3,000 pulse bi-directional encoder

OPTIONAL EQUIPMENT

Slide Base

This option is highly recommended for cutting flexible extrudates. While the cutter base is fixed and aligned with the puller, the cutter itself is mounted on a set of linear slides that allow as much as 12 inches of movement. The cutter can be moved away from the puller for startup, then moved close to the puller to enhance delivery to the cutter bushings.

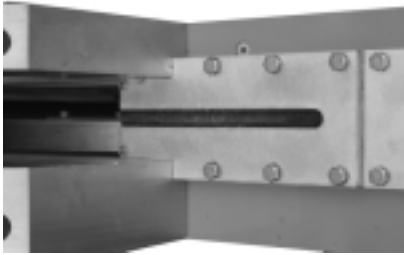

Blade Wipe

The blade wipe system keeps the cutting blade clean by removing lubricant and particles from the blade. A felt pad sandwiched between two pieces of stainless steel and mounted next to the bushing wipes the knife before each cut.

Custom Bushing Holder Sizes Available:

Round	Profile
2.25 inch (standard)	2x4 inch
3.25 inch	2x6 inch
4.25 inch	2x8 inch
5.25 inch	2x10 inch
	3x6 inch
	4x7 inch

Heavy Duty Blade Positions

- One blade position standard
- Optional 2 or 4 blade positions available
- Optional simitare blade available (see parts list for optional blades.)

OPTIONAL EQUIPMENT

Discharge Conveyor

A discharge conveyor facilitates the removal of cut parts. Discharge conveyors are available in the following sizes:

- 6 inches wide by 6 feet long
- 6 inches wide by 10 feet long
- 6 inches wide by 16 feet long

Isolation Transformer

The isolation transformer protects sensitive electronics from incoming power, which helps prevent errors caused by electrical noise. It also protects equipment from electrical noise generated by the servo motor and associated amplifier.

NOTE: An isolation transformer will not compensate for a ground that does not meet code requirements.

TIP: Conair strongly recommends the use of an isolation transformer. Ensuring clean and proper power can help avoid the need for costly service calls.

Left to Right Machine Operation

This option changes the machine direction from the standard right to left extrusion flow.

Special Paint Type or Color

This option covers any change from the standard Conair paint.

Your Conair sales representative can analyze your needs and recommend the options that are right for your system.

INSTALLATION

- **Unpacking the Boxes3-2**
- **Preparing for Installation3-3**
- **Positioning the SC-5
 Sure Cut3-4**
- **Connecting the Main
 Power Source3-6**
- **Installing the Encoder3-7**
- **Installing the Cutter
 Blades3-8**
- **Mounting the Cutter
 Bushings3-10**
- **Checking Repeatability3-12**
- **Preparing for Testing3-13**
- **Testing the Installation3-13**

UNPACKING THE BOXES

The SC-5 Sure Cut Series Servo Knife Cutter comes fully assembled in a single crate.



CAUTION: Lifting

To avoid personal injury or damage to the cutter, lift the cutter using a forklift or hoist with straps that have been positioned at the cutter's center of gravity.



- 1 Carefully uncrate the cutter and its components.**
- 2 Remove all packing material**, protective paper, tape, and plastic. Compare contents to the shipping papers to ensure that you have all the parts.
- 3 Carefully inspect all components** to make sure no damage occurred during shipping. Check all wire terminal connections, bolts, and any other electrical connections, which may have come loose during shipping.
- 4 Record serial numbers and specifications** in the blanks provided on the back of the User Guide's title page. This information will be helpful if you ever need service or parts.
- 5 You are now ready to begin installation.** Complete the preparation steps in *Preparing for Installation, Section 3*.

PREPARING FOR INSTALLATION

1 You need these tools for installation:

- wire strain relief
- 16- or 18-inch adjustable wrench
- set of Allen wrenches
- set of feeler gauges
- ½ inch open or box end wrench
- flashlight

2 Plan the location. Make sure the area where the servo cutter is installed has the following:

- **A grounded power source.** Check the cutter's serial tag for the correct amps, voltage, phase and cycles. All wiring should be completed by qualified personnel and should comply with your region's electrical codes.
- **Clearance for safe operation and maintenance.** Make sure there is enough clearance around the servo cutter for maintenance and servicing. If the servo cutter has the optional slide base, be sure to check for clearance by extending the slide system in both directions.



WARNING: Improper installation, operation, or servicing may result in equipment damage or personal injury.

This equipment should only be installed, adjusted, and serviced by qualified technical personnel who are familiar with the construction, operation, and potential hazards of this type of machine.

All wiring, disconnects, and fuses should be installed by qualified electrical technicians in accordance with electrical codes in your region. Always maintain a safe ground. Do not operate the equipment at power levels other than what is specified on the machine serial tag and data plate.

POSITIONING THE SERVO CUTTER

- 1 Move the servo cutter into position.** Place the servo cutter in position downstream of the belt puller.



CAUTION: Lifting

To avoid personal injury or damage to the cutter, lift the cutter using a forklift or hoist with straps that have been positioned at the cutter's center of gravity.

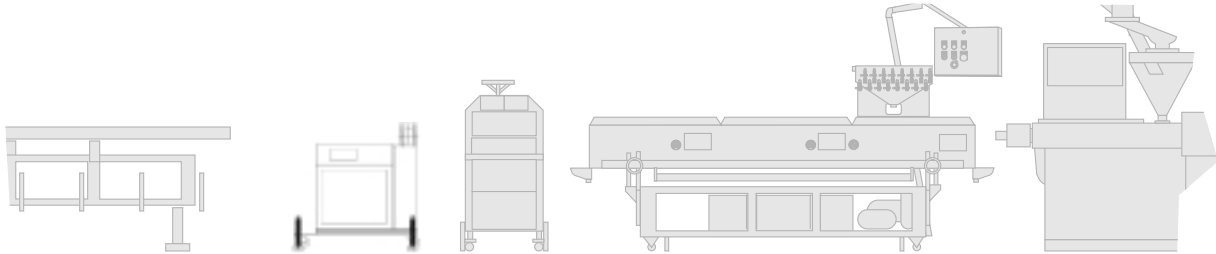

SC-5 Cutter

- 2 Determine the best distance** from the belt puller to the SC-5 Sure Cut cutter.

NOTE: If the slide base option was purchased, the cutting chamber can be slid back from the frame to allow ease of the string up procedure.

- **For flexible products,** the cutter should be located as close to the puller as possible to insure a minimum amount of space for the product between the point of exit of the puller and the inlet to the cutter bushing for most flexible products.
- **For rigid products,** allow some deflection space between the puller and cutter. This will minimize product sag or excessive deflection during cutting which could affect the cut length accuracy.

As a general rule, place the cutter such that you feel no shock from the cut with your fingernail placed on the extrudate on the entrance of the puller. If you feel shock from the cut, simply allow more space between the cutter and puller.

Continued

POSITIONING THE SERVO CUTTER CONTINUED

- 3** Align the cutter with the extrusion line.

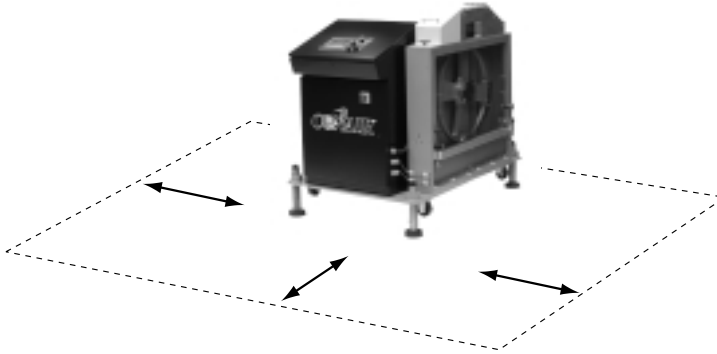

- 4** Measure the centerline height of the extrudate as it exits the extrusion die. Adjust all equipment on the extrusion line (sizing tank, cooling tanks, belt puller, and cutter) to this height.
- 5** Adjust the cutter's floorlock/caster assembly to the center height of the extrusion line using a 16- or 18-inch adjustable wrench. Once the correct height is reached, adjust the pad assembly to remove the weight from the casters for operation. This minimizes machine vibration during the cutting cycle.

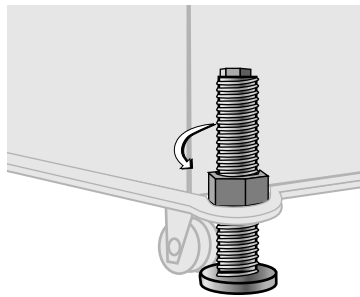

- 6** Use a plumb line or laser to check for a straight line from the extrusion die through each line component to the cutter bushings. Adjust as necessary.

CONNECTING THE MAIN POWER SOURCE



WARNING: Electrical hazard

Before performing any work on this product, disconnect and lock out electrical power sources to prevent injury from unexpected energization or start-up. A lockable device has been provided to isolate this product from potentially hazardous electricity.



WARNING: Improper installation, operation, or servicing may result in equipment damage or personal injury.

This equipment should only be installed, adjusted, and serviced by qualified technical personnel who are familiar with the construction, operation, and potential hazards of this type of machine.

All wiring, disconnects, and fuses should be installed by qualified electrical technicians in accordance with electrical codes in your region. Always maintain a safe ground. Do not operate the equipment at power levels other than what is specified on the machine serial tag and data plate.

IMPORTANT: Always refer to the wiring diagrams that came with your servo cutter before making electrical connections. The diagrams show the minimum size main power cable required for your cutter, and the most accurate electrical component information.

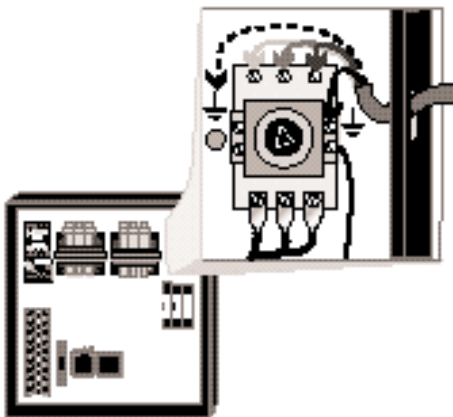

- 1 Open the servo cutter's electrical enclosure.** Turn the disconnect dial on the door to the OFF or O position and open the door.

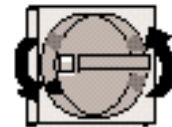

- 2 Insert the main power wire** through the knockout in the side of the enclosure. Secure the wire with a rubber compression fitting or strain relief.
- 3 Connect the power wires** to the terminals indicated on the wiring diagram that came with your machine.
- 4 Check every terminal screw** to make sure wires are secure. Gently tug each wire. If a wire is loose, use a screwdriver to tighten the terminal.
- 5 Connect the ground wire** to either grounding point shown in the diagram.



CAUTION: Handle with care.

The encoder is a delicate piece of equipment and must be handled gently.

INSTALLING THE ENCODER

Conair uses bi-directional encoders to ensure that only product that moves forward is counted.

Installing the encoder consists of several parts:

- the encoder
- the measuring wheel
- the connecting cable



Encoder



Wheels

The encoder is fitted with a one foot circumference wheel which rides on either the upper belt of the belt puller or (for rigid profiles and pipe) on the extrudate itself upstream of the puller.



Connecting Cable

The encoder is supplied with an integral mounting bracket. How and where you attach the encoder to the puller depends on your particular puller and application.

- If the wheel rides on the puller belt, make sure that its linear alignment is the same as the belt. Place the wheel near the center of the belt to minimize bouncing. Try to avoid cracks and other belt features that may effect accuracy.
- Make sure the location allows you to keep the wheel clean. Any small buildup on the wheel will effect its circumference and change the cut length.

After the encoder is installed, attach it to the cutter control using the supplied cable. The cable has been hard-wired to the control at the factory.

INSTALLING THE CUTTER BLADES



DANGER: Sharp blades!

Most injuries caused by knife blades occur when the cutter has been turned off. Handle blades with care at all times.



- Always lock out power to the cutter before opening the cutting chamber.
- Always wear cut-resistant gloves when the cutting chamber is open and when handling blades.
- Always wait until the cutter head has completely stopped before opening the knife guard.

SC-5 Sure Cut cutters are equipped with several safety devices to ensure safe operation. Never remove or disable these devices to sustain production. Operating without these devices can cause severe injury.



Never attempt to change or work on Blades without first locking out power to the machine.

- When the knife guard is opened, the knife guard switch stops the cutter.
- Two proximity-type safety switches prevent operation unless the cutter bushings are in place.
- The STOP button activates a circuit that stops the cutter head.

Installing the Cutter Blades

1 Shut off the main power disconnect and unplug the main power cord when entering the cutter housing. There is a safety interlock on the cutter blade housing that will deactivate the servo amplifier and control system.

2 Remove the screws holding the blades, remove the old blades and insert the new blades. The blade, or blades as the case may be, will fit onto a roll pin or in a machined slot with a blade clamp to squeeze or tighten. Secure the blade.

For more information about choosing the appropriate blade for your material, see the Appendix B.

Continued

TIP: We recommend that you:

- **Apply some protective cover on the portion of the blade you are handling**, such as masking tape to help prevent getting cut during installation and to leave it on until such time that you will start and check the cutting operation.
- **Check the length that the blade extends out of the cutter blade wheel.** The blade needs to be carefully checked to insure that the entire blade will pass completely through the product.

This is especially important with the very first installation and can be accomplished by rotating the wheel with the blade installed manually through the bushing and visually check to see that it will completely cover the entire bore of the bushing.



CAUTION: Never attempt to change or work on blades without first locking out power to the machine.



CAUTION: Use extreme caution as the blades will be very sharp. With the power off, the blade wheel can spin freely.

INSTALLING THE CUTTER BLADES CONTINUED

MOUNTING THE CUTTER BUSHINGS



DANGER: Sharp blades!

Always wear cut-resistant gloves when the cutting chamber is open and when handling blades. Never open cutting chamber without locking out the cutter power and waiting until the cutter head stops spinning.



The Bushings

Generally, the bushing will be in two parts, an inlet and an outlet with the inlet bushing being tapered or otherwise contoured to assist in guiding the product into the cutter mechanism. It is extremely crucial to the success of the cutting process that bushing bores be exact and in perfect alignment with each half. They should be polished smoothed, burr free and generally several thousands oversized for optimum performance.

Installation of the bushing

- 1** Open the top hinged cover (yellow) to expose the top of the bushing holder.
- 2** Use the two set screws positioned on top of the bushing holder and turn them counterclockwise to loosen and remove the bushings.
- 3** Replace the desired bushings and tighten up the two set screws just enough to barely be able to move the bushings.
- 4** Rotate the blade wheel until the blade enters the space between the two bushings.
- 5** Move the outlet bushing in until you can barely feel the blade scrape along the inside of the bushing.
- 6** Move the inlet bushing inward until there is about 0.001 to 0.003 inch clearance between the blade and the outlet bushing.
- 7** Tighten the two screws in the housing to lock in the bushings.
- 8** Rotate the blade wheel by hand so that the blade passes through the space between the two bushings to insure that it will clear without hitting either bushing and passes through the space with little effort.

Checking the Alignment of bushing to blade

Once you are sure that the blade will easily clear the bushings as it goes through the space you should then make some test cuts to insure quality.

- 1** Close the safety cover.
- 2** Turn on the Power (Rotary main disconnect).
- 3** Press the Green start button.
- 4** Do several test cuts by pressing the manual cut button.
- 5** Check the quality of the cuts. Adjust the bushing if necessary.

CHECKING THE ALIGNMENT OF THE BUSHINGS

For more information about setting and adjusting the gap for the bushings, see About Cutter Bushings in the Appendix C.

CHECKING REPEATABILITY

Before any Conair SC-5's are shipped, they are tested for cut time repeatability to be sure they are within performance specifications. The repeatability test checks the performance of the rotary knife cutter to return to the home park position after a complete cut. Acceptable repeatability times allowed for each cutter model prior to shipping are:

Type of Cutter	Repeatability Time
AC Pneumatic Cutter	Less than 1 millisecond
DC Pneumatic Cutter	Less than 1.5 millisecond
Positional Servo	Less than 0.1 millisecond

Note: 1-millisecond at 60 feet per minute is equal to 0.012 inches.

The repeatability mode is built into the Conair cutter controls and allows you to perform similar tests, without any external test equipment. It is recommended that you check repeatability on a regular basis. *Refer to Operation Section 4, Control Instructions Test* to run repeatability tests. Acceleration/deceleration delays of the servo do not contribute to repeatability error; any error is attributed solely to motor stability, couplings, assembly, power, and proximity sensor alignment.

Use any blade speed and line speed. The line speed is only seen while in the Encoder or Product modes. It is recommended that the tests be performed at cut intervals between 0.5 and 5-seconds. Do not change the blade speed or the line speed after starting the test.

PREPARING FOR TESTING

- 1 Make sure all components** are installed according to assembly drawings. Make sure that all bolts on the cutter have been tightened.
- 2 Check that cutter is firmly locked** into position with the anchoring screws.
- 3 Check that all wiring conforms to electrical codes**, and all wiring covers are in place.

TESTING THE INSTALLATION

- 1 Locate the main disconnect switch on the front of the control cabinet.** Turn it on. You should see the Redlion interface illuminate and start communications and the yellow power light should now be on.
- 2 Make sure the bushings and the blade doors are in place and secure.** Check that the bushing access door is closed and the threaded knob is tight and the E-stop is in the out position.
- 3 Press the green start button.** If the guard circuit is ready the green start button will now be illuminated.
- 4 Do a test cut, by pressing the black manual cut button.** You should have caused the flywheel to complete on test cut.
- 5 To enable the cutter, push the center arrow key.**

If for any reason any of these steps could not be achieved please refer to the troubleshooting section of the manual.

OPERATION

● <i>The Cutter Control</i>	4-2
● <i>Before Starting</i>	4-3
● <i>Powering Up</i>	4-3
● <i>Main Screen</i>	4-5
● <i>Total Screen</i>	4-6
● <i>Batch Screen</i>	4-7
● <i>Length Screen</i>	4-9
● <i>Preset to Run</i>	4-10
● <i>Time Preset</i>	4-11
● <i>Blade Speed</i>	4-13
● <i>Function Areas</i>	4-15
● <i>Test Screen</i>	4-16
● <i>Cut Mode</i>	4-18
● <i>Min. Measurement</i>	4-19
● <i>Maintenance Area</i>	4-19
● <i>Encoder Area</i>	4-20
● <i>Unit of Measure</i>	4-22
● <i>Scale Distance</i>	4-23
● <i>Homing</i>	4-25
● <i>Offset Example</i>	4-26
● <i>Preventative Maintenance</i>	4-27
● <i>Power On Time</i>	4-28
● <i>Checking Cut Quality</i>	4-29
● <i>Starting the SC-5 Sure Cut</i>	4-29
● <i>Making Adjustments</i> <i>During the Operation</i>	4-30
● <i>Stopping the SC-5 Sure Cut</i>	4-31

OPERATOR CONTROL FEATURES

The Operator Control provides an intuitive user-friendly method to interface with the Conair Servo Cutter. Information is viewed and entered at the Operator Control and is communicated to the servo positional amplifier via the RS-232 serial communication link.

The Operator Control is a flat membrane panel consisting of 22-keys and a large 2 line x 20 back lit LCD screen.

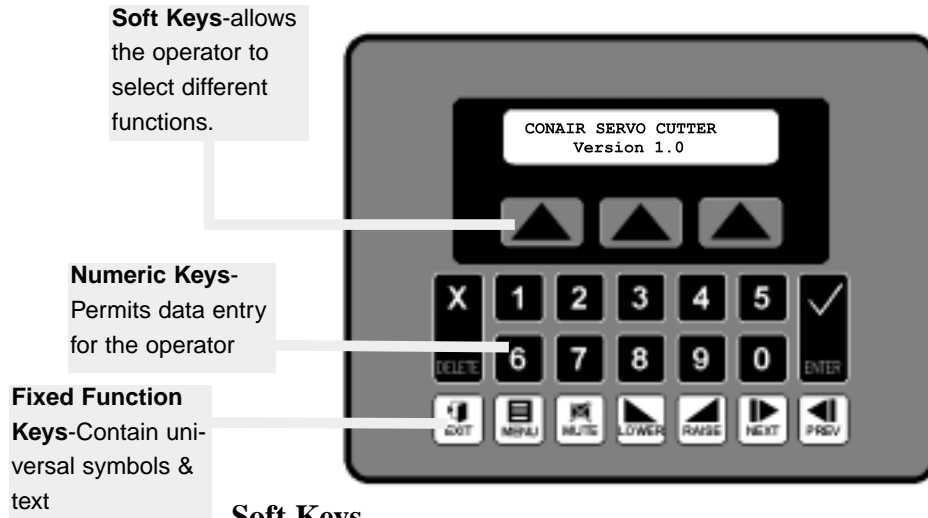

Soft Keys-allows the operator to select different functions.

Numeric Keys-Permits data entry for the operator

Fixed Function Keys-Contain universal symbols & text

Soft Keys

Soft keys - these are the three keys directly under the display. All three have a triangle on them. Occasionally, pages will appear that allow the operator to use one of the soft keys. On those occasions, text would typically appear directly above the key and the key will have a function. Think of the text as the soft key function indicator or title. These keys will be referred to in this manual from left to right as soft keys 1, 2 and 3 respectively.

Numeric keys

These are the black keys containing numbers 0 to 9. Numbers permit data entry of parameters. See Raise and Lower for value trim.

Fixed Function Keys (at Bottom)

Underneath the numeric keys are fixed function keys. They contain universal symbols and text. The fixed function keys are Raise, Lower, Next, Prev (previous), Enter, Delete, Exit, Menu and Mute. These functions are described in the "Function keys - Fixed Functions" section of this manual.

LCD Screen

The screen shows various pages depending on operator actions. In addition, it is used to indicate warnings. Mostly, it is used for viewing status and for setting parameters.

BEFORE STARTING

Before you start daily operation of the servo cutter, you need to perform preventative maintenance. Necessary maintenance is described in the Maintenance section of this Users Guide, see preventative maintenance, Section 5.



WARNING: Be sure that power to the SC-5 cutter is OFF when doing any maintenance on the servo cutter. Follow all safety rules when performing any maintenance on this equipment.

Daily maintenance includes:

- Inspecting the cutter blades
- Inspecting the blade mounting hardware
- Making sure the cutter bushings are properly secured
- Inspecting the closure latch on the knife guard
- Checking cutter alignment with extrusion line
- Performing any floor lock adjustments as needed

These items and weekly, monthly, and semi-annual maintenance procedures are detailed in the Maintenance section of this User Guide.

POWERING UP

- 1 Plug in the power cord** to restore power after any required maintenance.
- 2 Turn on the main power.** The cutter control will bootup. The amber power on light illuminates.

NOTE: You can watch the servo motor amplifier's status screen during bootup through the window on the back of the electrical enclosure. This display gives information that may be useful if you have a problem. See the Troubleshooting section.

While the cutter is booting up, perform the next three steps:

- 3 Make sure the E-Stop button is in the out, extended position.**
- 4 Make sure that the Cut Enable is Off.**
If necessary, press button to display off.
- 5 Press Start Cutter button.** The light in the button should light. On SC-5 cutters, the cutter head will make one revolution until it finds its home offset position.

Continued

POWERING UP

CONTINUED

Note: If “Home Runtime Failed” message is displayed. Check for malfunctions of misadjusted sensor.

- 6** **Open the knife guard.** The machine start push button should go out.

If the cutter is not working properly at any time, turn it off immediately and refer to the Troubleshooting section of this User Guide.

If you do not encounter any problems, proceed to the Operation section.

Power Up Sequence

At power up a series of system screens briefly appear. The software is Red Lion's Edict-97. This screen or similar shows first.



Next, the Communications message appears



If there are any problems with communications, this screen will remain on longer than a couple of seconds.

If there are no communication problems the Conair SC-5 Cutter program will begin to run. The following message or similar shows for 5-seconds.



After the 5 second delay the Main Screen will appear.

OPERATOR CONTROL INSTRUCTIONS MAIN SCREEN

MAIN SCREEN

There are two types of main screens, length or time measurement and cuts per minute measurement. The type displayed varies depending on the current cut mode setting. See the mode operator display overviews.

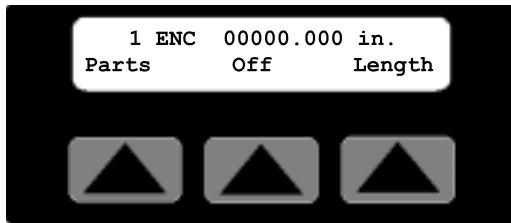

The Main Screen has seven features. The top line displays the active preset (only with multi preset option), cut mode, active measurement and the unit of measure. The bottom line contains three soft key functions, softkey1/Parts, softkey2/cut On/Off and softkey3, which varies depending on the current cut mode setting.

Active Preset

With the multi preset option in on-demand modes the active preset value changes upon batch completion. As the cutter sequences through multiple presets, the operator always knows which preset is being processed.

Active Measurement

The measurement value displayed will be the active length or time preset or cuts per minute depending on the active cut mode. It displays the value only when the machine is started and softkey2 On/Off is on. If the machine is stopped or softkey2 On/Off is off, this counter will be forced to zero. If a negative symbol is shown to the left of the measurement value, the encoder signal is reversed, i.e. rotating in the wrong direction. The Cutter will not function while the encoder is going negative. It is possible to correct this by using the encoder direction function located in the encoder area of the maintenance area. See the maintenance area display overview.

Length, Time or Blade Softkey

This key is mode dependent see the mode operator display overview for the current cut mode.

On/Off Softkey

Under the active measurement in the center of the bottom line of the display is a soft key labeled On or Off. Pressing this key while On is displayed will disable the cutter. Likewise pressing this key while Off is displayed enables the cutter. Pressing the stop button forces the cut enable off. Manual cuts can still be made while the cut enable is off.

CONTROL INSTRUCTIONS



Menu function key is used to access the Menu Area. This area can only be accessed from the main display screen for each mode. See the Menu Area section for more information.

Parts Select Area Screen

Under the current mode on the left side of the bottom line of the display is a soft key labeled Parts. Pressing this key accesses the Parts Select Screen.

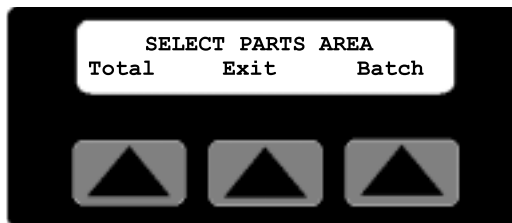

This screen provides access to the parts Total/softkey1 or Batch/softkey3 areas. Pressing Exit/softkey2 returns the display to the active main screen. If no selection is made within 30 seconds the display returns to the active main screen.



EXIT or PREV, fixed function keys return the display to the previous screen.

CONTROL INSTRUCTIONS

TOTAL SCREEN

TOTAL SCREEN

By pressing softkey1 located under the word Total on the Parts Select Screen, a seven-decade total counter is available. *Additional information on how to access this screen can be found in the operator display overview in Appendix E of this manual.*

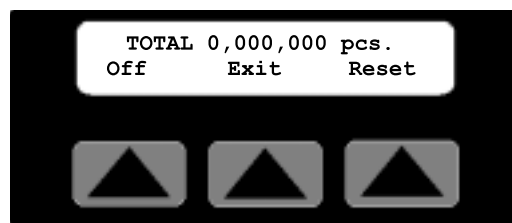

This is typically used to count cut pieces during the day or days that the product is being produced. Sample or manual cuts are not counted. When enabled the count continues to accumulate even if the total display is not being viewed. It is also possible to turn this counter off or on.

On/Off Softkey1

Under the counter on the left is a soft key labeled On or Off. Pressing this key while On is displayed will disable the counter. Likewise pressing this key while Off is displayed enables the counter.

Exit Softkey2

Under the counter, in the center is a soft key labeled Exit. Pressing this key will return the display to the Parts Select screen.

Continued

Reset Softkey3

Under the counter, on the right is a soft key labeled Reset. Pressing this key will zero the counter.

EXIT or PREV, fixed function keys return the display to the Parts Select screen.

BATCH SCREEN

By pressing softkey3 located under the word Batch on the Parts Select Screen, a six-decade Batch counter is available. *Additional information on how to access this screen can be found in the operator display overview in Appendix E of this manual.*

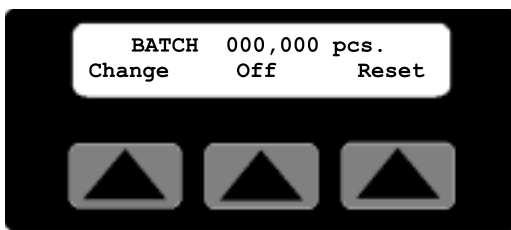

This is typically used to count the pieces required to fill a carton, with the product being cut. The batch counter counts up to the batch preset and resets to zero. As the accumulated count reaches the alarm preset the batch pre-warn output-3 energizes then when the batch preset is reached the batch complete output-2 briefly energizes and both outputs turn back off. Sample/Manual cuts are not counted. When enabled the count continues to accumulate even if the batch display is not being viewed. It is also possible to turn this counter off or on.

Change Softkey1

Under the counter, on the left is a soft key labeled Change. Pressing this key displays the Select Batch Area screen. The operator can then choose to set the batch or alarm preset.

On/Off Softkey2

Under the counter near the center is a soft key labeled On or Off. Pressing this key while On is displayed will disable the counter. Likewise pressing this key while Off is displayed enables the counter.

Reset Softkey3

Under the counter, on the right is a soft key labeled Reset. Pressing this key will zero the batch counter.

EXIT or PREV, fixed function keys return the display to the Parts Select screen.



**CONTROL
INSTRUCTIONS
TOTAL SCREEN
CONTINUED**

**CONTROL
INSTRUCTIONS
BATCH SCREEN**

Continued

CONTROL INSTRUCTIONS BATCH SCREEN CONTINUED

Batch Select Area Screen

Under the batch counter, on the left is a soft key labeled Change. Pressing this key displays the Select Batch Area screen. *Additional information on how to access this screen can be found in the operator display overview in Appendix E of this manual.*

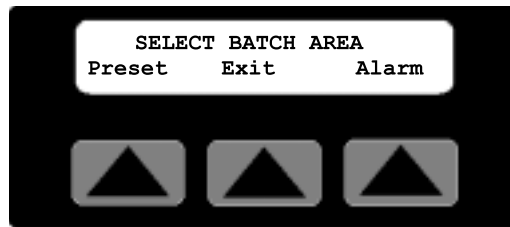

This screen provides access to the batch Preset/softkey1 or batch Alarm/softkey3 areas. Pressing Exit/softkey2 returns the display to the batch counter screen. If no selection is made within 30 seconds the display returns to batch counter screen.

Batch Preset Screen

By pressing the soft key located under the word Batch on the Batch Area Screen, the preset for the Batch counter is available.



The number shown is the current batch preset. A cursor will appear in the least significant digit. The user has a choice of ways to adjust this number.



Exit or Prev, If no change is required press Exit or Prev to return to the Main screen.



Raise will increase the preset by 1. The key can be pressed once for each increment required or held down to scroll up. Releasing the key will freeze the preset at the last value.



Lower will decrease the preset by 1. The key can be pressed once for each decrement required or held down to scroll down. Releasing the key will freeze the preset at the last value.

Continued

Numeric keys

Key in the batch required and press enter. If you require a batch of 50 parts you must key in 50 and then press enter.

Enter or Delete?

If the keyed in number is correct press the enter key for it to be accepted and return to the Main screen. If it is wrong press the delete key and the previous preset will reappear.

Batch Pre-Alarm Preset Screen

By pressing the soft key located under the word Alarm on the Batch Area Screen, the preset for the Batch pre-warn Alarm is available.

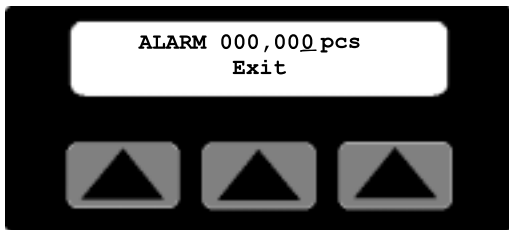

The number shown is the current alarm preset. A cursor will appear in the least significant digit. The user has a choice of ways to adjust this number. See entering the batch preset above. Please note: This value must be less than the batch preset.

Exit or Prev, if no change is required press Exit or Prev to return to the Main screen.



CONTROL INSTRUCTIONS BATCH SCREEN CONTINUED

LENGTH SCREEN

By pressing the soft key located under the word Length on the Encoder, Follower or Auto Mode Main Screen, the preset for the Length counter is available. *Additional information on how to access this screen can be found in the operator display overview in Appendix E of this manual.*

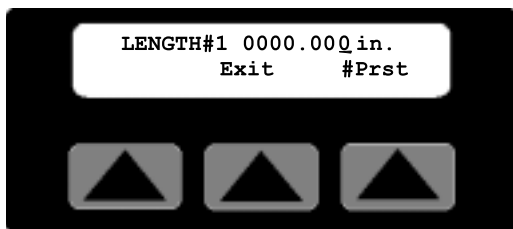

The number shown is the current length preset value, i.e. the length to cut the product. A cursor will appear in the least significant digit. The user has a choice of ways to adjust this number. Pressing the #Prst/Softkey3 accesses the number of presets to run screen. This feature is only available with the multiple preset/batch option.

CONTROL INSTRUCTIONS LENGTH SCREEN

Continued

CONTROL INSTRUCTIONS LENGTH SCREEN CONTINUED



Exit or Prev, if no change is required press Exit or Prev to return to the Main screen.



Raise will increase the preset by 0.010 inch. The key can be pressed once for each 0.010 inches increment required or held down to scroll up. Releasing the key will freeze the preset at the last value then press enter.



Lower will decrease the preset by 0.010 inch. The key can be pressed once for each 0.010 inch decrement required or held down to scroll down. Releasing the key will freeze the preset at the last value then press enter.

Numeric keys

Key in the length required and press enter. The decimal place is fixed so remember this when entering the preset. If you require 24 inches you must key in 24000 and then press enter. Keying only 24 will set the length to 0.024 inches.

Enter or Delete?

If the keyed in number is correct press the enter key for it to be accepted and return to the Main screen. If it is wrong press the delete key and the previous preset will reappear.

CONTROL INSTRUCTIONS PRESET TO RUN SCREEN

PRESETS TO RUN SCREEN

By pressing the soft key located under the word #Prst on any Length Screen, the value for the number of presets to run is available. *Additional information on how to access this screen can be found on the multiple preset example in the operator display overview in Appendix E of this manual.*



The number shown is the current number of presets to run value, i.e. how many measurement presets and batches to run. The acceptable range for this value is 1 to 4. The cutter will process preset#1/batch#1 then #2 then #3 then #4 and back to #1 continuously. If a 2 is entered only preset/batch 1 and 2 are processed. A cursor will appear in the least significant digit. The user has a choice of ways to adjust this number.

Continued

Exit or Prev, If no change is required press Exit or Prev to return to the previous Length Screen.

Raise will increase the number by 1. The key can be pressed once for each increment of 1 required or held down to scroll up. Releasing the key will freeze the preset at the last value then press enter.

Lower will decrease the preset by 1. The key can be pressed once for each decrement of 1 required or held down to scroll down. Releasing the key will freeze the preset at the last value then press enter.

Numeric keys

Key in the number required and press enter. If you require 4 presets key in 4 and then press enter.

Enter or Delete?

If the keyed in number is correct press the enter key for it to be accepted and return to the Main Timer Mode screen. If it is wrong press the delete key and the previous preset will reappear.



CONTROL INSTRUCTIONS PRESET TO RUN SCREEN CONTINUED

TIME SCREEN

By pressing the soft key located under the word Time on the Main Timer Mode Screen, the preset for the timer is available. *Additional information on how to access this screen can be found in the operator display overview in Appendix E of this manual.*

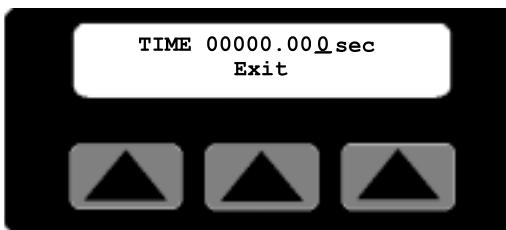

The number shown is the current time preset value, i.e. the time interval to cut the product. A cursor will appear in the least significant digit. The user has a choice of ways to adjust this number.

Exit or Prev, If no change is required press Exit or Prev to return to the Main Timer Mode Screen.



CONTROL INSTRUCTIONS TIME SCREEN

Continued

CONTROL INSTRUCTIONS TIME SCREEN CONTINUED



Raise will increase the preset by 0.010 second. The key can be pressed once for each 0.010 second increment required or held down to scroll up. Releasing the key will freeze the preset at the last value then press enter.



Lower will decrease the preset by 0.010 second. The key can be pressed once for each 0.010 second decrement required or held down to scroll down. Releasing the key will freeze the preset at the last value then press enter.

Numeric keys

Key in the time required and press enter. The decimal place is fixed so remember this when entering the preset. If you require 1.5 seconds you must key in 1500 and then press enter. Keying only 15 will set the time to 0.015 seconds.

Enter or Delete?

If the keyed in number is correct press the enter key for it to be accepted and return to the Main Timer Mode screen. If it is wrong press the delete key and the previous preset will reappear.

CONTROL INSTRUCTIONS HOLD-OFF SCREEN

HOLD-OFF TIME SCREEN

By pressing the soft key located under the word Time on the Main End Sense Mode Screen, the preset for the hold-off timer is available. *Additional information on how to access this screen can be found in the operator display overview in Appendix E of this manual.*



The number shown is the current hold-off time preset, i.e. the time interval to ignore the photo eye and avoid false cuts. A cursor will appear in the least significant digit. The user has a choice of ways to adjust this number.

Exit or Prev, If no change is required press Exit or Prev to return to the Main End Sense Mode Screen.



Continued

Raise will increase the preset by 0.010 second. The key can be pressed once for each 0.010 second increment required or held down to scroll up. Releasing the key will freeze the preset at the last value then press enter.



Lower will decrease the preset by 0.010 second. The key can be pressed once for each 0.010 seconds decrement required or held down to scroll down. Releasing the key will freeze the preset at the last value then press enter.



CONTROL INSTRUCTIONS HOLD-OFF SCREEN CONTINUED

Numeric keys

Key in the time required and press enter. The decimal place is fixed so remember this when entering the preset. If you require 1.000 seconds you must key in 1000 and then press enter. Keying only 1 will set the time to 0.001 seconds and an error message will be displayed.

Enter or Delete?

If the keyed in number is correct press the enter key for it to be accepted and return to the Main End Sense Mode screen. If it is wrong press the delete key and the previous preset will reappear.

BLADE SPEED SCREEN

By pressing the soft key located under the word Blade or Speed depending on the current mode, the preset for that modes blade speed is available. *Additional information on how to access this screen can be found in the operator display overview in Appendix E of this manual.*

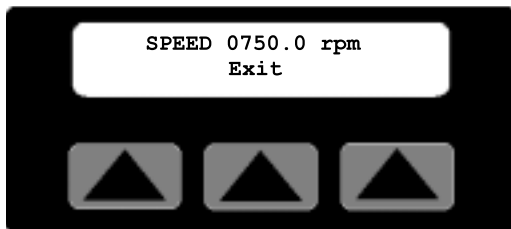

The number shown is the active modes current blade speed preset, i.e. the speed the blade will pass through the part. A cursor will appear in the least significant digit. The user has a choice of ways to adjust this number.

Exit or Prev, if no change is required press Exit or Prev to return to the Blade Select or Main Mode Screen.



CONTROL INSTRUCTIONS BLADE SPEED SCREEN

Continued

CONTROL INSTRUCTIONS BLADE SPEED SCREEN

CONTINUED



Raise will increase the preset by 1.0. The key can be pressed once for each 1.0 increment required or held down to scroll up. Releasing the key will freeze the preset at the last value then press enter.



Lower will decrease the preset by 1.0. The key can be pressed once for each 1.0 decrement required or held down to scroll down. Releasing the key will freeze the preset at the last value then press enter.

Numeric keys

Key in the time required and press enter. The decimal place is fixed so remember this when entering the preset. If you require 750.0 rpm you must key in 7500 and then press enter. Keying only 750 will set the speed to 075.0 rpm and an error message with the valid range will be displayed.

Enter or Delete?

If the keyed in number is correct press the enter key for it to be accepted and return to the Blade Select or Main Mode Screen. If it is wrong press the delete key and the previous preset will reappear.

CONTROL INSTRUCTIONS BLADE COUNT SCREEN

BLADE COUNT SCREEN

By pressing the soft key located under the word Blade or Count depending on the current mode, the preset for the blade count is available. *Additional information on how to access this screen can be found in the operator display overview in Appendix E of this manual.*

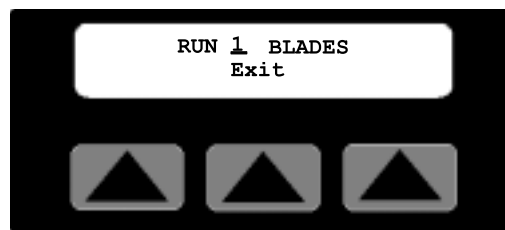

The number shown is the current blade count preset, i.e. the number of blades mounted to the cutter head. A cursor will appear in the least significant digit. The user has a choice of ways to adjust this number.

Exit or Prev, if no change is required press Exit or Prev to return to the Blade Select or Main Mode Screen.



Continued

Raise will increase the preset by 1. The key can be pressed once for each 1 increment required or held down to scroll up. Releasing the key will freeze the preset at the last value then press enter.



CONTROL INSTRUCTIONS BLADE COUNT SCREEN



CONTINUED

Lower will decrease the preset by 1. The key can be pressed once for each 1 decrement required or held down to scroll down. Releasing the key will freeze the preset at the last value then press enter.

Numeric keys

Key in the number of blades mounted and press enter. If the value entered is out of range an error message with the valid range will be displayed.

Enter or Delete?

If the keyed in number is correct press the enter key for it to be accepted and return to the Blade Select or Main Mode Screen. If it is wrong press the delete key and the previous preset will reappear.

FUNCTION AREAS

Additional information on how to access and navigate these screens can be found in the operator display overview section of this manual.

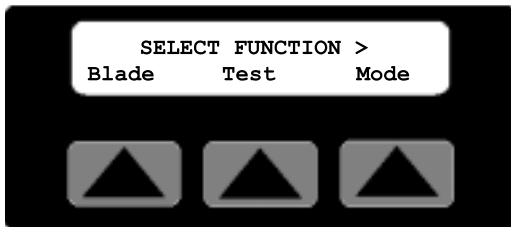

CONTROL INSTRUCTIONS FUNCTION AREAS

Menu fixed function key is used to access the Function Areas from any main mode screen. There are two Function Area screens. The user can toggle between the two screens with the Next and Prev fixed function keys.

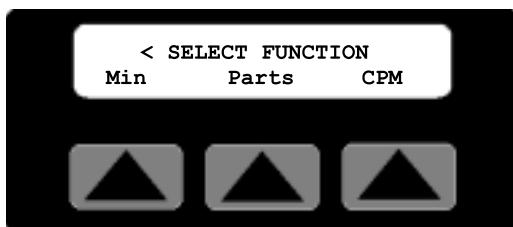

Continued

CONTROL INSTRUCTIONS FUNCTION AREAS CONTINUED



Next or Prev, Pressing Next selects the second Function Area. Pressing Prev returns the display to the first Function Area screen. Pressing Prev from the first Function Area screen returns the display to the active main mode screen.



Menus are a convenient way to access and monitor parameters that do not need to be altered often, i.e. blade speed, blade count, cut mode, repeatability test, min. allowable measurement and cuts per minute.

The most frequently used functions for a certain cutting mode are directly available from the main screen for the active mode. For a guide to screen navigation for any active mode see the operator display overview section of this manual for that mode. For information on the Blade and Parts Softkeys see their respective sections covered earlier in this manual.

CONTROL INSTRUCTIONS TEST

TEST SOFTKEY

Pressing soft key two located under the word Test on the first Function area screen, selects the repeatability tester.

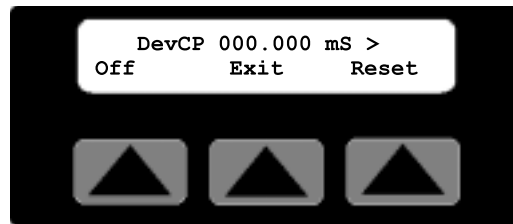

The DevCP repeatability tester displays total deviation time in milliseconds. This time is from a cut being requested until the blade reaches the part. The smallest measured value is subtracted from the largest measured value and the resulting deviation is displayed on the screen. New data is sampled every consecutive cut. The DevCP repeatability test is available in all on-demand modes. This test is used as a tool for verifying the accuracy of the cutter.

On/Off Softkey1

On the display, on the lower left side is a soft key labeled On or Off. Pressing this key while On is displayed will reset all values and disable testing. Likewise pressing this key while Off is displayed starts the test.

Reset Softkey3

On the display, on the lower right side is a soft key labeled Reset. Pressing this key will reset all test values and start a new test.



Exit or Prev, Pressing Exit, Prev or the Softkey under the word Exit resets all values and disables testing then returns the display to the Function area screen.

Continued

Next, Pressing Next selects the DevCC test if available. If the arrow on the top right hand side of the screen is visible the current mode also supports the DevCC test.



CONTROL INSTRUCTIONS TEST

CONTINUED

NOTE: The test available DevCP, DevCC or both is dependent on the active cut mode.

The DevCC repeatability tester also displays total deviation time in milliseconds. This time is from a cut being requested until the next cut request. The smallest measured value is subtracted from the largest measured value and the resulting deviation is displayed on the screen. The DevCC repeatability test is available in some on-demand modes, and all continuous modes. This test is used as a tool for verifying the accuracy of the upstream puller or the precision timer option.

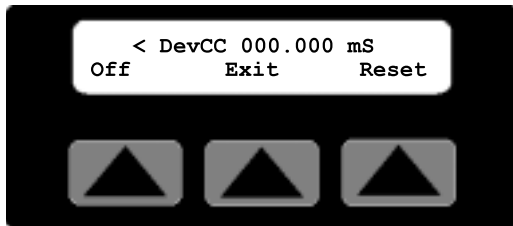

On/Off Softkey1

On the display, on the lower left side is a soft key labeled On or Off. Pressing this key while On is displayed will reset all values and disable testing. Likewise pressing this key while Off is displayed starts the test.

Reset Softkey3

On the display, on the lower right side is a soft key labeled Reset. Pressing this key will reset all test values and start a new test.

Exit, Pressing Exit or the Softkey under the word Exit resets all values, disables testing then returns the display to the Function area screen.



Prev, Pressing Prev selects the DevCP test if available. If the arrow on the top left hand side of the screen is visible the current mode also supports the DevCP test.



NOTE: The test available DevCP, DevCC or both is dependent on the active cut mode.

CONTROL INSTRUCTIONS CUT MODE

Mode Softkey

By pressing the soft key located under the word Mode, the different Cut Modes are available. There are two Cut Mode screens. The first screen provides choices for the standard-modes available on all cutters.

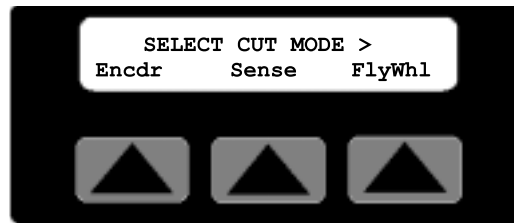

The second screen displays choices for optional cut modes. The user can toggle between the two screens with the Next and Prev fixed function keys. Additional information on how to access these screens can be found in the function area of the operator display overview section of this manual.

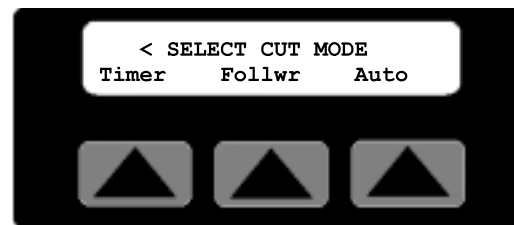

Press the Softkey located under the cut mode desired to select that mode. If the mode is available an acknowledgment will be displayed.

**CUT MODE SET TO
** MODE SELECTED ****

This message will be displayed for 3 seconds or until any key is pressed.

Next or Prev, Pressing Next selects the second Cut Mode Area. Pressing Prev returns the display to the first Cut Mode Area. Pressing Prev from the first Cut Mode Area screen returns the display to the Function Area screen.



Min Softkey

By pressing the soft key located under the word Min on the second Function Area Screen, the Minimum allowable measurement value is displayed. The active mode and the

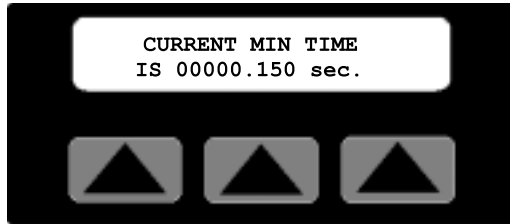

cuts per minute limit for the model of cutter determines the actual value displayed. The screen will be displayed for 15 seconds or until any key is pressed, then return to the second Function Area screen.

CPM Softkey

By pressing the soft key located under the word CPM on the second Function Area Screen, the calculated cuts per minute are displayed.

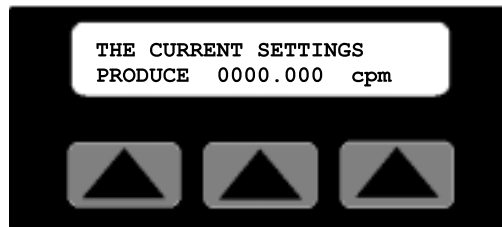

The active mode, measurement value, blade speed, number of blades and line speed may all contribute to determining the actual value displayed. The screen will be displayed for 15 seconds or until any key is pressed, then return to the second Function Area screen.

CONTROL INSTRUCTIONS MINIMUM MEASUREMENT

MAINT. AREA



Menu function key is used from the first Function Area screen to access the Maintenance area. There are two menus Maint. and Factory, with access via password to various sub-menus.



CONTROL INSTRUCTIONS MAINTENANCE AREA

CONTROL INSTRUCTIONS ENCODER AREA

Menus are a convenient way to access and monitor parameters that do not need to be altered often, i.e. home position, encoder direction, scale or unit of measure. In addition, preventive maintenance parameters can be monitored for troubleshooting and scheduling purposes.

Factory Softkey

This area is password protected for factory use only. Please do not attempt to get around the password protection as parameters beyond this point are used for calibration and setup. These parameters should only be modified by trained personal. Improper settings will reduce the performance and possibly cause severe damage to your machine.

Maint. Softkey

Located under the word Maint. is the Maintenance soft key. The Maintenance area is password protected. This area should only be accessed by qualified personal.



After pressing the Maintenance Softkey, the password entry screen is displayed. With the numeral keys press 6 2 0 9 then the Enter key to access the maintenance area. An improper password will cause this message to be displayed for 3 seconds.

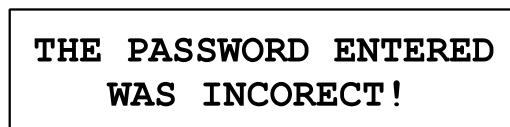

There are three sub-menus, Encdr, Home, and P/M accessible in the maintenance area.

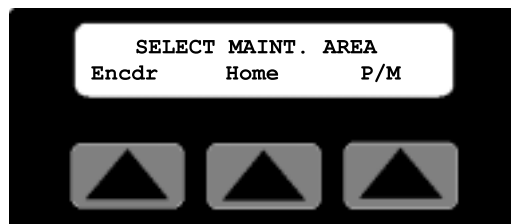

Exit or Prev, Pressing Exit or Prev will return the display to the Menu Area screen.



Continued

Encdr Softkey

By pressing the soft key located under the word Encdr on the Maint. Area Screen, there are three sub-menus, Drctn, U/M, and Scale accessible. Additional information on how

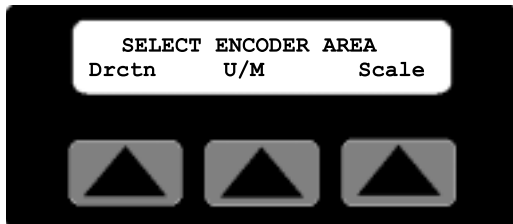

to access this screen can be found in the Maintenance Area of the operator display overview section of this manual.

Exit or Prev, Pressing Exit or Prev will return the display to the Maint. Area screen.



CONTROL INSTRUCTIONS ENCODER AREA CONTINUED

DIRECTION SOFTKEY

By pressing the soft key located under the word Drctn on the Encdr. Area Screen, the direction of the encoder rotation can be changed. Located on the lower left side of the display is the status text (INCORRECT/CORRECT) for the encoder direction.

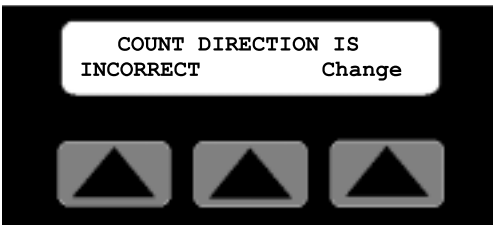

Exit or Prev, Pressing Exit or Prev will return the display to the Encoder Area screen.



CONTROL INSTRUCTIONS ENCODER DIRECTION

Change Softkey

With the machine stopped, by pressing the soft key located under the word Change. The direction of the encoder is reversed. After the change if the count direction is positive, the status text will now display the word CORRECT.

Attempting to change the encoder direction with the cutter running will result in the following message.

**THE CUTTER MUST BE
STOPPED TO CHANGE!**

This message will be displayed for 3 seconds or until any key is pressed. Press stop on the operator panel then try again.

Continued

CONTROL INSTRUCTIONS ENCODER DIRECTION CONTINUED

If a negative symbol is shown to the left of the count value on the main mode screen the encoder signal is reversed, i.e. rotating in the wrong direction. The Cutter will not function while the encoder is going negative. The Direction function corrects this by changing what the servo drive interprets as a positive direction, CW or CCW rotation.

CONTROL INSTRUCTIONS UNIT OF MEASURE

UNIT OF MEASURE SOFTKEY

By pressing the soft key located under the word U/M on the Encoder Area screen, the Eng. Units can be set.

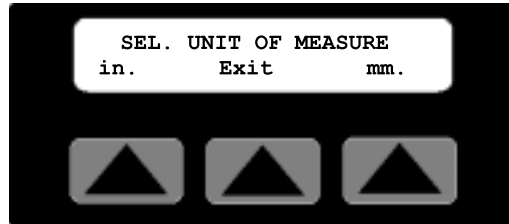

Exit or Prev, Pressing Exit or Prev will return the display to the Encoder Area screen.

in./mm. Softkeys

Pressing the soft key located under in. or mm. Changes all displayed measurements to the respective unit of measure. The scaled distance must now be set for the desired unit. See the Scale Area Dist. Softkey description.

Scale Softkey

By pressing the soft key located under the word Scale on the Encoder Area Screen, there are two sub-menus, Dist., and Counts accessible. *Additional information on how to access this screen can be found in the Maintenance Area of the operator display overview in Appendix E of this manual.*

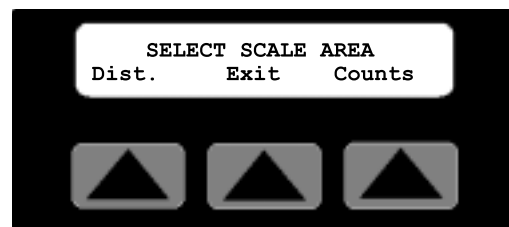

Exit or Prev, Pressing Exit or Prev will return the display to the Encoder Area screen.

SETTING THE SCALE FACTOR

The Encoder mode uses a scale factor to compensate for configurations that differ from the standard (a measuring wheel with a 1 foot circumference; a 3000 bi-directional quadrature pulse encoder; and English units of measure). The prescale value is set at the factory for your equipment and typical unit of measurement. However, it may occasionally be necessary to adjust the prescale value.

CONTROL INSTRUCTIONS SCALE DISTANCE

DISTANCE SOFTKEY

By pressing the soft key located under the word Dist. on the Scale Value Screen, the scaled distance is available. This value must be set after a U/M change. *Additional information on how to access this screen can be found in the Maintenance Area of the operator display overview in Appendix E of this manual.*

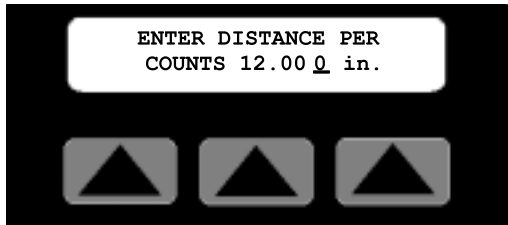

The number shown is the current distance value, i.e. the circumference of the measuring wheel or distance per revolution of the encoder. A cursor will appear in the least significant digit.

Exit or Prev- if no change is required press Exit or Prev to return to the Scale Value screen.



Raise will increase the value by 0.001inch. The key can be pressed once for each 0.001inch increment required or held down to scroll up. Releasing the key will freeze the value at the last value.



Lower will decrease the value by 0.001inch. The key can be pressed once for each 0.001inch decrement required or held down to scroll down. Releasing the key will freeze the value at the last value.



Numeric keys

Key in the distance desired and press enter. The decimal place is fixed so remember this when entering the value. If you require 12.000 inches you must key in 12000 and then press enter. Keying only 12 will set the distance to 0.012 inches.

Enter or Delete?

If the keyed in number is correct press the enter key for it to be accepted and return to the Scale Value screen. If it is wrong press the delete key and the previous value will reappear.

CONTROL INSTRUCTIONS SCALE COUNTS

COUNTS SOFTKEY

By pressing the soft key located under the word Counts on the Scale Value Screen, the scaled counts are available. *Additional information on how to access this screen can be found in the Maintenance Area of the operator display overview in Appendix E of this manual.*

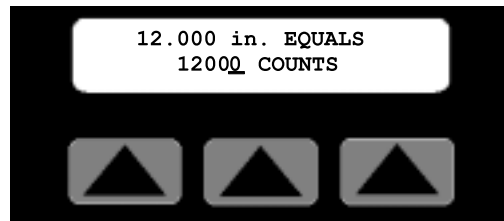

The number shown is the current count value, i.e. the pulses per revolution of the encoder. For example a 3000 pulse quadrature encoder will produce 3000 x 4 channels or 12000 counts. A cursor will appear in the least significant digit. The user has a choice of ways to adjust this number.



Exit or Prev, if no change is required press Exit or Prev to return to the Scale Value screen.



Raise will increase the value by 1. The key can be pressed once for each 1 increment required or held down to scroll up. Releasing the key will freeze the value at the last value.



Lower will decrease the value by 1. The key can be pressed once for each 1 decrement required or held down to scroll down. Releasing the key will freeze the value at the last value.

Numeric keys

Key in the count desired and press enter. If you require 12000 counts you must key in 12000 and then press enter.

Enter or Delete?

If the keyed in number is correct press the enter key for it to be accepted and return to the Scale Value screen. If it is wrong press the delete key and the previous value will reappear.

CONTROL INSTRUCTIONS HOMING

HOMING

A defined Home location is required for all servo-positioning applications. After initial power up, emergency stop or guard opened, home position must be found. All motion is relative to this home position. The Home cycle occurs once after power is applied to the servo drive in response to the Start push button being pressed. The cutter head rotates towards the home sensor at the programmed On-Demand blade speed. After the home sensor has been found, the cutter head will decelerate and stop at the specified offset position. This position is then set to 0.0 degrees at the end of the home sequence. If the home sensor is not found in one revolution of the cutter head, the following message is displayed on the operator.

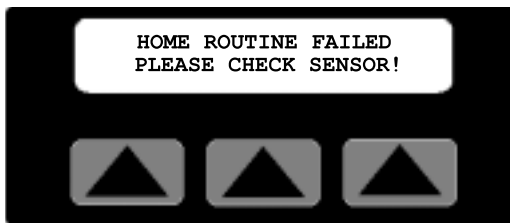

The sensor may be faulty, have a loose connection or be improperly adjusted. Press any key on the operator to acknowledge the fault. Disconnect power, fix the problem then restart the cutter.

After a successful home has been completed, if the cutter is stopped away from the home position and the power to the machine is left on, the cutter head position is still known. When the cutter is restarted, the cutter head will return at the programmed On-Demand blade speed to the home position.

HOME OFFSET SCREEN

By pressing the soft key located under the word Home on the Maintenance Screen, the offset for the home position is available. *Additional information on how to access this screen can be found in the Maintenance Area of the operator display overview in Appendix E of this manual.*

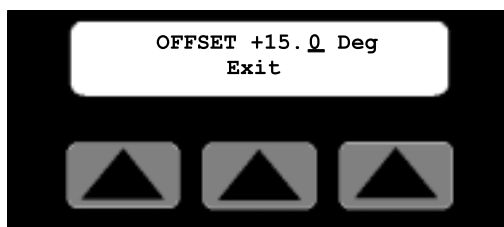

The number shown is the current offset value, i.e. the distance from position zero. A cursor will appear in the least significant digit. The user has a choice of ways to adjust this number.

Exit or Prev, If no change is required press Exit or Prev to return to the Maintenance Area screen.



Continued

CONTROL INSTRUCTIONS HOME OFFSET

CONTROL INSTRUCTIONS HOME OFFSET CONTINUED



Raise will increase the value by 1.0. The key can be pressed once for each 1.0 increment required or held down to scroll up. Releasing the key will freeze the value at the last value.



Lower will decrease the value by 1.0. The key can be pressed once for each 1.0 decrement required or held down to scroll down. Releasing the key will freeze the value at the last value.

Numeric keys

Key in the distance desired and press enter. The decimal place is fixed so remember this when entering the value. If you require 15.0 degrees you must key in 150 and then press enter. Keying only 15 will set the distance to 01.5 degrees.

Enter or Delete?

If the keyed in number is correct press the enter key for it to be accepted and return to the Maintenance Area screen. If it is wrong press the delete key and the previous value will reappear.

CONTROL INSTRUCTIONS OFFSET EXAMPLE

HOME OFFSET EXAMPLE

With the Cut Enable on/off turned off and the cutter started, entering a new value at the Home Offset screen will initiate a home routine using the new value.

The graphic example above demonstrates the resulting home position with a 15 degree offset.

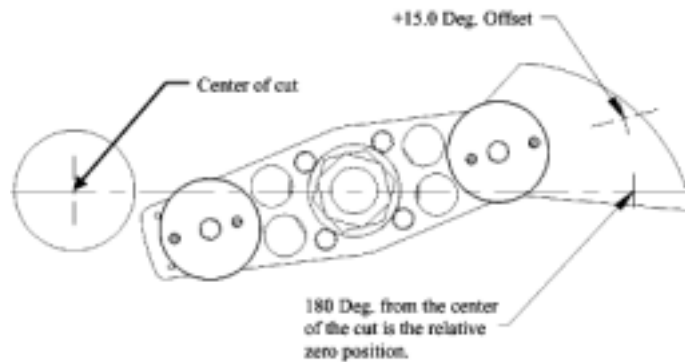

The acceptable range for this value is 00.0 to +45.0 degrees. Making an entry outside of this range generates the following error message on the operator display.



After 5 seconds or if any key is pressed the display returns to the Home Offset

CONTROL INSTRUCTIONS PREVENTIVE MAINTENANCE

PREVENTIVE MAINTENANCE SOFTKEY

Pressing the soft key located under the word P/M on the Maint. area screen. Selects the P/M area screen. Three preventive maintenance sub-menus for monitoring Inputs, Time and Cycles are displayed.

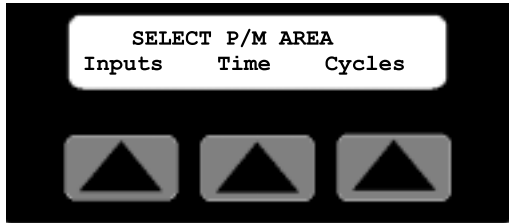

Additional information on how to access this screen can be found in the Maintenance Area of the operator display overview in Appendix E of this manual.

Inputs Softkey

Pressing the soft key located under the word Inputs on the P/M area screen, selects the inputs monitoring screen.

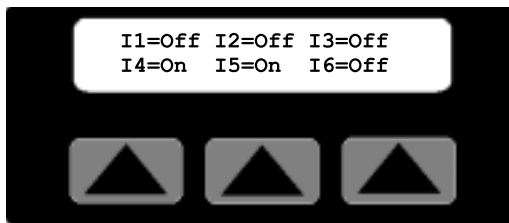

This screen displays the cutters input status. Active inputs are equal to On and de-energized inputs are equal to Off. This information could be used for troubleshooting with out the use of a meter.

- Input #1 = End Sense Trigger when On
- Input #2 = Run when Off
- Input #3 = Manual Cut Trigger when On
- Input #4 = Home Registration when On
- Input #5 = E-Stop when Off
- Input #6 = Spare

Exit or Prev, Pressing Exit or Prev returns the display to the Select P/M area screen.



CONTROL INSTRUCTIONS POWER ON TIME

TIME SOFTKEY

Pressing the soft key located under the word Time on the P/M area screen, selects the Power-On time screen.

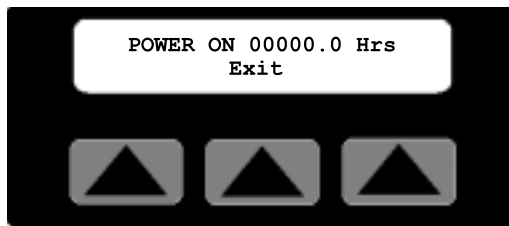

The Power-On time screen displays the total time in hours that the machine has had the power switched on. This information could be used for scheduling preventive maintenance. The displayed time can not be reset.



Exit or Prev, Pressing Exit, Prev or the Softkey under the word Exit returns the display to the Select P/M area screen.

Cycles Softkey

Pressing the soft key located under the word Cycles on the P/M area screen, selects the machine cycles screen.

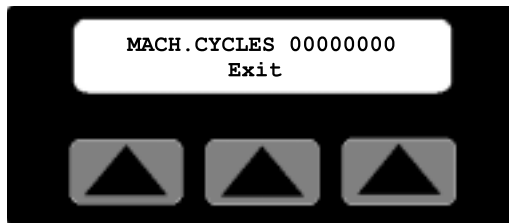

The Machine Cycles screen displays the absolute total cuts that the machine has made since manufacture. This information could be used for scheduling preventive maintenance. The displayed count can not be reset.

Exit or Prev, Pressing Exit, Prev or the Softkey under the word Exit returns the display to the Select P/M area screen.



CHECKING CUT QUALITY

- 1 Press the manual cut button** and observe the movement of the cutter blade. The cutter head makes a single rotation and the blade moves through the cutter bushings without interference.
- 2 Insert a piece of extrudate through the cutter bushings.**
- 3 Press the manual cut button.** A single cut is made at the preset blade speed. (This works even if Cut On/Off is off.)
- 4 Inspect the cut.** If necessary, adjust the blade design or blade speed. *See All About Cutter Blades, Appendix B.*

If you have not already done so, check the cutter hardware, power up the cutter, select cutting mode and blade speed, and make a test cut to check cut quality.

STARTING THE SC-5 CUTTER

When you are satisfied with cut quality, press the Cut On/Off soft key and on is displayed, automatic operation begins.

When the extrudate is running within tolerance, cut it with a knife or saw and feed it through the cutter bushings.

MAKING ADJUSTMENTS DURING OPERATION

There are several adjustments you can make during normal cutting. These adjustments include:

- **In Timer mode**, adjust the time between cuts
- **In Encoder and Follower modes**, adjust the length
- **In Product mode**, adjust the hold-off time
- **In Flywheel mode**, adjust blade speed
- **Adjust blade speed in all modes except Follower**
- **Perform a manual cut and reset the length** by pressing the manual cut button at any time during on-demand cutting. Pressing Reset/Test has no effect during continuous cutting.
- **Count the total number of cuts** by pressing the Total On/Off soft key. Use the Reset button to return the count to zero. This feature is useful for collecting samples during a production run.
- **Count the batches of cuts** by pressing the Total On/Off soft key. Use the Reset button to return the count to zero. This feature is useful for collecting samples during a production run.
- **Stop cutting temporarily** by setting Cut On/Off to off. This allows you to view the cutting blade (through the window) or perform other tasks without shutting down the cutter.

NOTE: While the controller will allow you to switch modes during operation, this is not recommended.



WARNING: Never stop the servo cutter by opening the knife guard.

This can cause damage to the equipment and injury to personnel.

STOPPING THE SC-5 CUTTER

Use this procedure to safely stop the servo cutter:

- 1 Press Cut On/Off soft key** to stop cutting (soft key text changes to off).
- 2 Press Stop Cutter button** to disable the servo motor (start light is off).
- 3 Turn the rotary disconnect to the off position.**



WARNING: Never turn off the rotary disconnect first.

Doing so will turn off all power to the unit, and the cutter will not be brought to a controlled stop. For safe stopping, always follow the sequence given above.

- 4 Disconnect the power cord** if it is equipped with a plug on the end.
- 5 Lock out the rotary disconnect.**
- 6 Clean the lubricant reservoir** if you are shutting the servo cutter down for the day.

MAINTENANCE

- **Maintenance Features**5-2
- **Warnings and Cautions**5-2
- **Maintenance Overview**5-4
- **Preventative Maintenance**
 - Schedule**5-4
- **Checking the Blades**5-6
- **Inspecting Cutter**
 - Bushing Screws**5-7
- **Checking the Closure Latch** . . .5-7
- **Cleaning the Blade Tray**5-8
- **Lubricating the Slide**
 - Rail System**5-8
- **Adjusting the**
 - Proximity Switches**5-9
- **Checking Electrical**
 - Connections**5-10
- **BLoc Installation and**
 - Removal**5-12

MAINTENANCE FEATURES

The Servo Cutter SC-5 Sure Cut models needs regular, scheduled maintenance for peak performance. Among the features that require maintenance are:

- Cutter blades
- Blade mounting hardware
- Cutter bushings
- The knife guard hardware
- Cutter alignment
- Floor locks
- Lubrication tray
- Shafts of optional slide rail system
- Electrical cables
- Control panel lights

WARNINGS AND CAUTIONS

To maintain the best performance of the servo cutter, it must be cleaned and inspected regularly. Maintenance includes a daily, weekly, quarterly, and semi-annual (every 6 months) schedule.

Use this maintenance schedule as a guide. You may need to shorten the time of the maintenance schedule, depending on how often you use the servo cutter, and the types of material flowing through it.

Follow all precautions and warnings when working on the equipment.



WARNING: Improper installation, operation, or servicing may result in equipment damage or personal injury.

This equipment should only be installed, adjusted, and serviced by qualified technical personnel who are familiar with the construction, operation, and potential hazards of this type of machine.

All wiring, disconnects, and fuses should be installed by qualified electrical technicians in accordance with electrical codes in your region.

Continued



WARNING: Voltage Hazard

This equipment is powered by alternating current, as specified on the machine serial tag and data plate. Do not operate the equipment at power levels other than what is specified on the machine serial tag and data plate.

A properly-sized conductive ground wire from the incoming power supply must be connected to the chassis ground terminal inside the electrical enclosure. Improper grounding can result in severe personal injury and erratic machine operation.

LOCKOUT/TAGOUT:

Before performing maintenance or repairs on this product, disconnect and lock out electrical power sources to prevent injury from unexpected energization or start-up. A lockable disconnect device has been provided to isolate this product from potentially hazardous electricity.



DANGER: Sharp blades!

Most injuries caused by knife blades occur when the cutter has been turned off. Handle blades with care at all times.



- Always wear cut-resistant gloves when the cutting chamber is open and when handling blades.
- Always lock out the cutter before opening the cutting chamber. (See Lockout/tagout above)
- Always wait until the cutter head has stopped completely before opening the knife guard.

SC-5 Sure Cut cutters are equipped with several safety devices to ensure safe operation. Never remove or disable these devices to sustain production. Operating without these devices can cause severe injury.

- When the knife guard is opened, the knife guard switch stops the cutter but does not remove powder from the drive.
- Two proximity-type safety switches prevent operation unless the cutter bushings are in place.
- The STOP button activates a circuit that stops the knife.

WARNINGS AND CAUTIONS

CONTINUED

MAINTENANCE OVERVIEW

This section describes the daily, weekly, monthly and semi-annual maintenance schedules that should be performed when changing materials or lines, or when changing equipment, as well as the maintenance procedures to follow.

Cutting either flexible or rigid materials generates tremendous shock and vibration to the entire unit. Anything that can loosen, will over time.

To maintain the best performance, follow this maintenance schedule and develop an effective preventative maintenance program.

PREVENTATIVE MAINTENANCE SCHEDULE

● Daily

☐ **Checking cutter blade(s)**

Clean, sharpen or replace as needed (see *Checking the Blades, Section 5*).

☐ **Inspecting the blade mounting hardware**

The blade securing bolt should use both a lock washer and flat washer, and be tightened enough to fully compress the lock washer. Replace the holding pins if they appear worn.

☐ **Inspecting the cutter bushing screws**

Check that the cutter bushing screws are secure (see *Inspecting Cutter Bushing Screws, Section 5*).

☐ **Checking the closure latch on the knife guard**

See *Checking the Closure Latch, Section 5*.

☐ **Inspecting cutter alignment**

Proper cutter alignment is critical for optimum performance. Use a plumb line or laser to check for a straight line from the extrusion die to the cutter bushings.

☐ **Check floor locks**

It is always recommended that the weight be removed from the casters for optimum stability during cutting cycles. Check to see if the floor locking mechanism is properly adjusted.

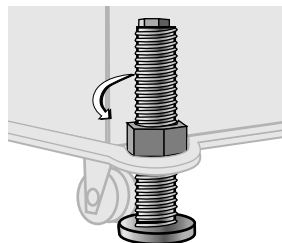

Continued

PREVENTATIVE MAINTENANCE SCHEDULE CONTINUED

● Weekly

- Cleaning the blade lubrication tray (if the cutter has this option).** See *Cleaning the Blade Tray, Section 5.*
- Lubricating shafts on optional slide rail system**
See *Cleaning the Blade Tray, Section 5.*

● Monthly

- Checking hardware on the knife guard**
Inspect the hardware on the knife guard (fasteners on hinge and the clear blade guard window). Tighten as needed.
- Checking bushing holder proximity switches**
Inspect the sets screws which retain the bushing holder proximity switches for tightness. Adjust as needed. See *Adjusting the Proximity Switches, Section 5.*

- Checking the draw latch**
Inspect the latch on knife guard windows for wear and

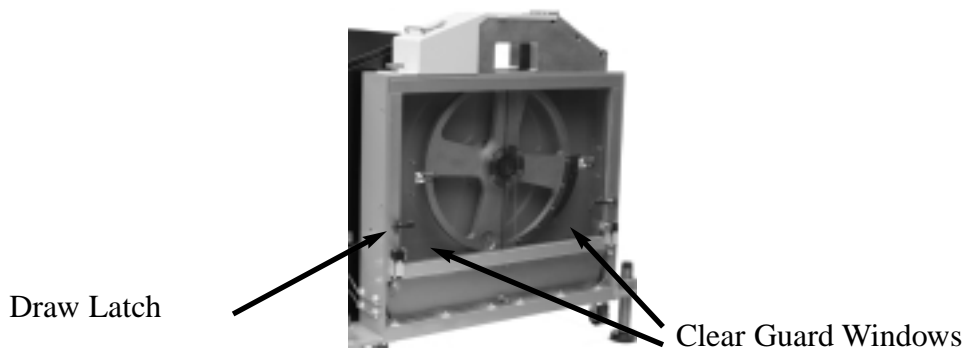

- Clean the clear blade guard window**
Clean using glass cleaner or plain water. Other materials may cause premature loss of clarity or crazing.

● Semi-annual (every 6 months)

- Inspecting electrical terminals**
Check all electrical terminals for tightness; adjust as needed. See *Checking Electrical Connections, Section 5.*
- Checking torque on Trantorque coupling device**
Check the tightness (torque) of the Trantorque coupling device with a torque gauge. This device connects the cutter head to the Micron reducer shaft. See *Checking Torque, Section 5.*
- Checking all electrical cables**
Inspect all electrical cables for cuts and abrasions.
Replace as needed.
- Inspecting control panel lights**
Check to make sure no LEDs or lights are burned out on the control panel. Replace as needed.

CHECKING BLADES

Blades become dull over time depending on the material being cut, cut rate, blade speed, and blade material and thickness. Check blades regularly for sharpness as well as scratches, nicks, burrs, and material buildup. Clean, sharpen or replace as needed (see *Installing Cutter Blades, Section 3*).



DANGER: Sharp blades!

Most injuries caused by knife blades occur when the cutter has been turned off. Handle blades with care at all times.



- Always wear cut-resistant gloves when the cutting chamber is open and when handling blades.
- Always lock out the cutter before opening the cutting chamber.
- Always wait until the cutter head has stopped completely before opening the knife guard.

SC-5 Sure Cut cutters are equipped with several safety devices to ensure safe operation. Never remove or disable these devices to sustain production. Operating without these devices can cause severe injury.

- When the knife guard is opened, the knife guard switch stops the cutter and prevents starting the cutter again.
- Two proximity-type safety switches prevent operation unless the cutter bushings are in place.
- The STOP button activates a circuit that stops the knife.

Check the set screws that secure the cutter bushings. If bushings move during cutting, cutting blades and possibly the drive chain could be damaged.

INSPECTING CUTTER BUSHING SCREWS

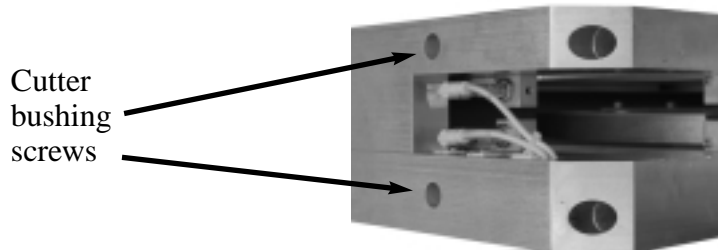

Check the hand knob and tighten it so the knife guard closes completely. This prevents false triggering of the safety switch.

CHECKING THE KNIFE GUARD



CLEANING THE BLADE TRAY (OPTIONAL)

This tray is built into the cutter assembly as a simple method of applying lubrication to your blade during cutting cycles. Depending on cut rate and type of material and lubrication, the area will need to be cleaned on a regular basis and the lubricant replaced. Open the clear guard windows and, using a shop vac or other similar equipment, remove all liquid and solids from the cutting chamber and around the bushings. Replace the lubricant. For more information, see *Blade and Bushing Lubrication, Appendix D*.

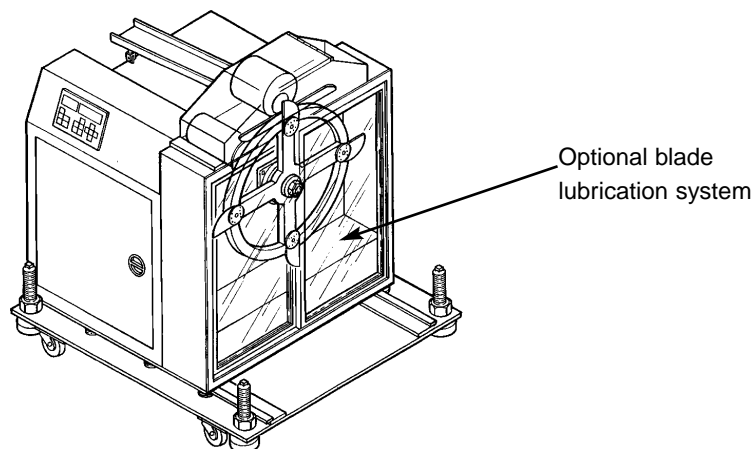

LUBRICATING THE SLIDE RAIL SYSTEM (OPTIONAL)

Check the shafts on the slide rail system. Even though these shafts are stainless steel, it is recommended that a light oil (WD-40 or similar) be applied to the shafts as needed. Wipe off any excess.

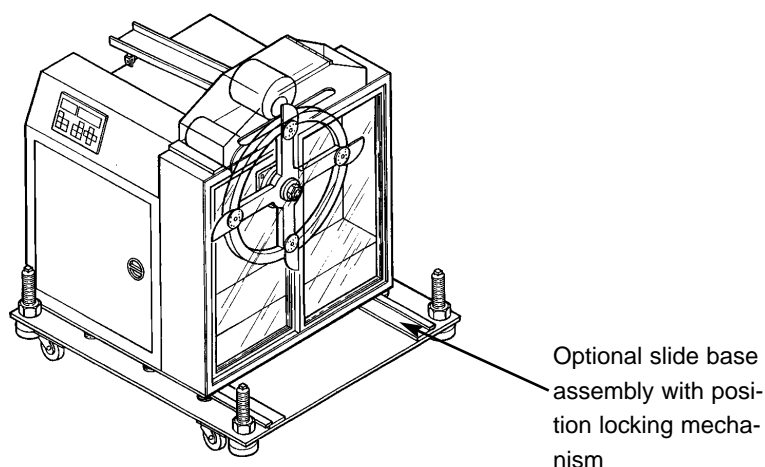

Follow all warnings and cautions listed at the beginning of the Maintenance section of this User Guide.

ADJUSTING THE PROXIMITY SWITCHES

- 1 Be sure the main power is disconnected** and the cutter is locked out.
- 2 Loosen the set screws** that hold the cutter bushings.
- 3 Remove the cutter bushings.**
- 4 Check the depth of the proximity switch face for each bushing.** It should be recessed no more than 0.010 inches, but should not interfere with the bushings themselves.

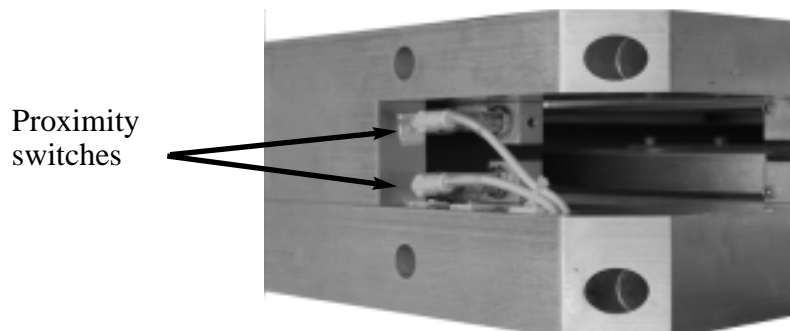

- 5 Check the tightness of each proximity switch's retaining screw.** Use an Allen wrench to perform this task.

IMPORTANT: You can damage the proximity switch if you over-tighten the retaining screw.

- 6 Replace cutter bushings** and check for proper cutting blade alignment. See *Mounting the Cutter Bushings, Section 3 and the Appendix A and C.*
- 7 Plug in the power cord** and turn the main power disconnect to the on position if all other maintenance is completed.

CHECKING ELECTRICAL CONNECTIONS



WARNING: Electrical hazard

Before performing any work on this product, disconnect and lock out electrical power sources to prevent injury from unexpected energization or start-up. A lockable device has been provided to isolate this product from potentially hazardous electricity.



WARNING: Improper installation, operation, or servicing may result in equipment damage or personal injury.

This equipment should only be installed, adjusted, and serviced by qualified technical personnel who are familiar with the construction, operation, and potential hazards of this type of machine.

All wiring, disconnects, and fuses should be installed by qualified electrical technicians in accordance with electrical codes in your region. Always maintain a safe ground. Do not operate the equipment at power levels other than what is specified on the machine serial tag and data plate.

- 1 Be sure the main power is disconnected and the cutter is locked out.** Always disconnect and lock out the main power source before opening the unit or servicing.
- 2 Turn the main power disconnect to the off position** before opening the electrical enclosure on the back of the cutter, or the back of the control. This is a safety device to prevent you from opening the doors if the power is still on.



Main power safety disconnect

Continued

-
- 3** **Open the electrical enclosure.**
 - 4** **Inspect all wires and connections.** Look for loose wires, burned contacts, and signs of over-heated wires. Have a qualified electrician make any necessary repairs or replacements.
 - 5** **Close the electrical enclosure door.**
 - 6** **Inspect the exterior power cords.** Cords should not be crimped, exposed, or rubbing against the frame. If the main power cord runs along the floor, make sure it is not positioned where it could rest in pooling water or could be run over and cut by wheels or casters.

CHECKING ELECTRICAL CONNECTIONS CONTINUED

INSTALLATION AND REMOVAL INSTRUCTIONS FOR B-LOC™ LOCKING ASSEMBLY SERIES B112

Thank you for purchasing a **B-LOC™** Keyless Frictional Locking Device. **B-LOC™** keyless connectors provide a high capacity, zero-backlash shaft/hub or coupling connection by means of a mechanical interference fit. Please follow these **INSTALLATION AND REMOVAL INSTRUCTIONS** carefully to ensure proper performance of this **B-LOC™** unit.

ⓘ WARNING ⓘ

When installing or removing **B-LOC™** products, always adhere to the following safety standards:

1. Be sure that all power switches are locked out before installing or removing **B-LOC™** products.
2. Eye protection is required when installing or removing **B-LOC™** products - please wear safety glasses and protective clothing.

INSTALLATION

(Refer to Figures 1 and 2)

B-LOC™ Locking Assemblies are supplied lightly oiled and ready for installation. When reinstalling a used unit, make sure that all slits are aligned and that front and rear clamp collars are not reversed (when assembled correctly there are no holes or threads behind taps in clamp collar Item 1, and no threads behind taps in center collar Item 3). The frictional torque capacity of these devices is based on a coefficient of friction of 0.12 for lightly oiled screw, taper, shaft and bore contact areas.

Therefore, it is important not to use Molybdenum Disulfide (e.g., Molykote, Never-Seeze or similar lubricants) in any Locking Assembly installation.

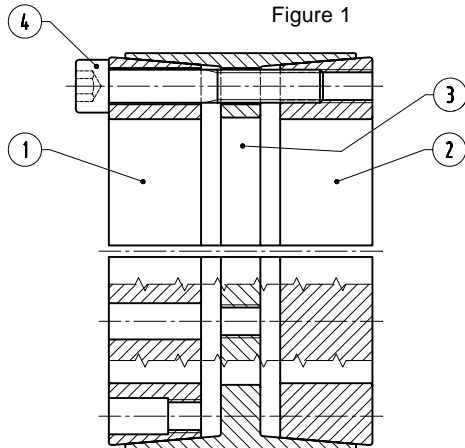

Figure 1

1. Make sure that locking screw, taper, shaft and bore contact areas are clean and lightly oiled and that all collar slits are aligned.
2. Loosen all locking screws by a minimum of four (4) turns and transfer at least two (2) screws to push-off threads in clamp collar Item 1 to disengage this part from center collar Item 3. Similarly, transfer at least two (2) screws to push-off threads in center collar Item 3 to disengage this part from clamp collar Item 2 (see Figure 2).
3. Completed assembly can now be placed on shaft and inserted into hub bore by pushing against face of collar Item 1 while ensuring that collar Item 2 is not engaged at tapers during this phase.
4. After placement of Locking Assembly, relocate locking screws used for separation of collars.
5. Hand tighten connection and confirm that clamp collar Item 1 is parallel with face of part to be attached to shaft and/or with the front facing edge of center collar Item 3.
6. Use torque wrench and set it approximately 5% higher than specified tightening torque M_A . Tighten locking screws in either a clockwise or counterclockwise sequence (it is not necessary to tighten in a diametrically opposite pattern), using only 1/4 (i.e., 90°) turns for several passes until 1/4 turns can no longer be achieved.
7. Continue to apply overtorque for 1 to 2 more passes. This is required to compensate for a system-related relaxation of locking screws since tightening of a given screw will always relax adjacent screws. Without overtightening, an infinite number of passes would be needed to reach specified tightening torque.
8. Reset torque wrench to specified torque (M_A) and check all locking screws. No screw should turn at this point, otherwise repeat Step 7 for 1 or 2 more passes. It is not necessary to re-check tightening torque after equipment has been in operation.

NOTE: In installations subjected to extreme corrosion, the slits in clamp collars Item 1 and Item 2, as well as in center collars, should be sealed with a suitable caulking compound or equivalent. Likewise, push-off threads should also be protected from corrosion.

INSTALLATION OF B-LOC™ LOCKING ASSEMBLIES OVER SHAFT KEYWAYS

The Locking Assembly should be positioned so that slits in Locking Assembly collars that contact the shaft are located approximately opposite the keyway. In addition, a locking screw should be centered directly over the keyway.

When tightening locking screws, it is important to follow the installation procedure outlined above, which specifies equal 1/4 turns of each locking screw. Failure to follow these instructions could result in excessive tightening of the screw over the keyway, possibly causing permanent deformation of the Locking Assembly collars. Even after 1/4 turns can no longer be achieved, it is important to continue to use equal turning angles for every screw until the specified tightening torque is reached.

REMOVAL

(Refer to Figure 2)

Prior to initiating the following removal procedure, check to ensure that no torque or thrust loads are acting on the Locking Assembly, shaft or any mounted components.

IMPORTANT! Make sure ends of locking screws used for removal are ground flat and are slightly chamfered to prevent damage to screw and collar threads during push-off.

1. Check to ensure that axial movement of clamp collars - necessary for release of connection - is not restricted. Likewise, ensure that push-off threads are in good condition.
2. Remove all locking screws. Transfer required number of screws into all push-off threads of clamp collar Item 1 (see Figure 2).
3. Release collar Item 1 by progressively tightening all push-off screws. Typically, the push-off screws appear to be completely tight after just one pass of tightening without any noticeable separation of clamp collars. Although it seems that the screws cannot be tightened further, several more rounds of torquing in either a clockwise or counterclockwise sequence will increase the push-off force in the system and ultimately release part of the front collar. Afterwards, only the screws which are still tight should be tightened further until complete dismounting is achieved. Remove clamp collar Item 1.
4. Transfer locking screws used for dismounting of clamp collar Item 1 into all push-off threads in center collar Item 3 (see Figure 2). Release clamp collar Item 2 by repeating procedures outlined in Step 3.

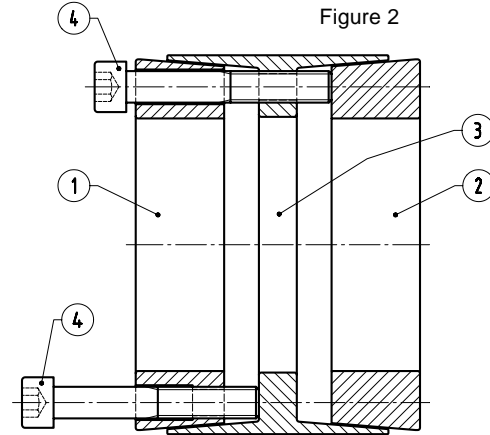

Figure 2

LOCKING SCREW SIZES AND SPECIFIED TIGHTENING TORQUE M_A B112 LOCKING ASSEMBLY

Metric Series	Inch Series	Tightening Torque M_A (ft-lbs)	Screw Size	Hex Key Size (mm)
25 x 55 to 35 x 60	1 to 1-7/16	12	M 6	5
40 x 75 to 65 x 95	1-1/2 to 2-9/16	30	M 8	6
70 x 110 to 90 x 130	2-5/8 to 3-5/8	60	M 10	8
100 x 145 to 120 x 165	3-3/4 to 4-3/4	105	M 12	10
130 x 180 to 160 x 210	4-15/16 to 6	166	M 14	12
170 x 225 to 260 x 325	6-7/16 to 8	257	M 16	14
280 x 355 to 340 x 425		500	M 20	17
360 x 455 to 600 x 695		675	M 22	17

TROUBLESHOOTING

- ***Before Beginning***6-2
- ***A Few Words of Caution***6-2
- ***Identifying the Cause of a Problem***6-3
- ***Electrical Problems***6-4
- ***Product Quality Problems***6-8

Repair

- ***Replacing Safety and Proximity Switches***6-12
- ***Checking the Servo Amplifier***6-12
- ***Adjusting the Proximity Switches***6-14
- ***Checking the Encoder***6-15
- ***Checking the Motor/Reducer Assembly***6-17
- ***Checking Repeatability***6-18

BEFORE BEGINNING

You can avoid most problems by following the recommended installation, operation and maintenance procedures outlined in this User Guide. If you have a problem, this section will help you determine the cause and tell you how to fix it.

Find any wiring, parts, and assembly diagrams that were shipped with your equipment. These are the best reference for correcting a problem. The diagrams will note any custom features or options not covered in this User Guide.

Verify that you have all instructional materials related to the servo knife cutter. Additional details about troubleshooting and repairing specific components are found in these materials.

Check that you have manual for other equipment connected in the system. Troubleshooting may require investigating other equipment attached to, or connected with the cutter.

A FEW WORDS OF CAUTION



WARNING: Improper installation, operation, or servicing may result in equipment damage or personal injury.

This equipment should only be installed, adjusted, and serviced by qualified technical personnel who are familiar with the construction, operation, and potential hazards of this type of machine.

All wiring, disconnects, and fuses should be installed and adjusted by qualified electrical technicians in accordance with electrical codes in your region. Always maintain a safe ground. Do not operate the equipment at power levels other than what is specified on the machine serial tag and data plate.



WARNING: Electrical hazard

Before performing maintenance or repairs on this product, disconnect and lock out electrical power sources to prevent injury from unexpected energization or start-up. A lockable device has been provided to isolate this product from potentially hazardous electricity.

Continued



DANGER: Sharp blades!

Most injuries caused by knife blades occur when the cutter has been turned off. Handle blades with care at all times.



- Always wear cut-resistant gloves when the cutting chamber is open and when handling blades.
- Always lock out power to the cutter before opening the cutting chamber.
- Always wait until the cutter head has stopped completely before opening the knife guard.

SC-5 Sure Cut cutters are equipped with several safety devices to ensure safe operation. Never remove or disable these devices to sustain production. Operating without these devices can cause severe injury.

- When the knife guard is opened, the knife guard switch stops the cutter and prevents starting the cutter again.
- Two proximity-type safety switches prevent operation unless the cutter bushings are in place.
- The STOP button activates a circuit that stops the knife.

A FEW WORDS OF CAUTION CONTINUED

The Troubleshooting section covers problems directly related to the operation and maintenance of the servo cutter. This section does not provide solutions to problems that originate with other equipment. Additional troubleshooting help can be found in manuals supplied with the other equipment.

The main problems you will see with the servo cutter are:

- **Cutter operation problems**, which focus on problems that are clearly related to the operation of the cutter's electrical control systems.
- **Plastic product quality concerns**, which deal with product characteristics that may be related to cutter operation. Of course, other sections of the extrusion line also influence the quality of the extruded product. This section does not provide solutions to problems originating with other equipment on the extrusion line.

Additional troubleshooting help can be found in the manufacturer's manuals included with this User Guide.

IDENTIFYING THE CAUSE OF A PROBLEM

ELECTRICAL PROBLEMS

Look in this section when you have problems such as lights on the control that are working improperly, buttons that do not execute the function properly, and when information input is not executed properly.

Symptom	Possible cause	Solution
<p>◆ The green start button does not illuminate when pressed</p>	<p>The E-stop button is pushed in.</p>	<p>Pull out the E-stop button.</p>
		<p>Check to see if:</p> <ul style="list-style-type: none"> <input type="checkbox"/> The blade guard is closed. <input type="checkbox"/> Master Control relay (MCR) has failed. Replace relay.
	<p>A safety switch has failed.</p>	<p>Check connections and replace if needed.</p>
<p>◆ Pressing the cut enable soft key and cutter does not start cutting</p>	<p>There is a loose connection.</p>	<p>Check wiring between cutter control and the relay.</p>
	<p>The relay is bad.</p>	<p>Repair or replace the relay.</p>
<p>◆ Pressing the Reset/Test button does not produce a cut when in an on-demand mode.</p>	<p>The guard circuit failed.</p>	<p>Check guard circuit, repair or replace components.</p>
	<p>The servo amplifier is not in Program mode.</p>	<p>Check servo, if necessary, reboot main power.</p>
	<p>There is a loose connection.</p>	<p>Check wiring and tighten connection.</p>

ELECTRICAL PROBLEMS CONTINUED

Symptom	Possible cause	Solution
◆ After pressing Start Cutter, the cutter head rotates slowly but does not stop.	The Blade home proximity switch failed or the connection to it is loose.	Check connections and replace switch if needed.
◆ Master safety relay does not energize	Guard circuit is open.	Check to see if: <ul style="list-style-type: none"><input type="checkbox"/> The blade guard is closed.<input type="checkbox"/> Loose connection to guard circuit. Tighten connection.<input type="checkbox"/> Guard switch is bad. Replace switch.
◆ While in Encoder mode, no count is displayed	Input from encoder failed.	Check encoder cable for continuity. Connect any loose wires.
	Encoder failed.	Replace encoder.

ELECTRICAL PROBLEMS

CONTINUED

Symptom	Possible cause	Solution
<p>◆ In encoder or timer modes, the display shows the count which resets, but a cut does not occur at the point of reset.</p>	<p>There is a problem with the cutter control.</p>	<p>Check for control output.</p>
	<p>There is a problem with the servo amplifier.</p>	<p>See Checking the Servo Amplifier.</p>
	<p>There is a loose connection.</p>	<p>Check wiring for loose connections.</p>
<p>◆ Cutter stops and nothing is displayed</p>	<p>There is an anti-jam circuit signal.</p>	<p>This error appears when the blade does not go through the cut cycle in the required time. Check for:</p> <ul style="list-style-type: none"> <input type="checkbox"/> Loose connection on cutter control or servo amplifier. <input type="checkbox"/> Fault on Amplifier preventing cut cycle. <input type="checkbox"/> Blade is stuck in extrudate/bushings. <input type="checkbox"/> Look at the drive and record the fault code and call the Conair service department.
	<p>There is a problem with the home proximity switch.</p>	<p>See Adjusting the Proximity Switches, Section 5.</p>

ELECTRICAL PROBLEMS CONTINUED

Symptom	Possible cause	Solution
◆ Blade speed does not change when new speed is entered into the control.	There is a communication failure between the control and drive.	Check for wiring for loose connections and tighten.
◆ Cutter mode selection does not change cut mode.	There is a communication failure between the control and drive.	Check for wiring for loose connections and tighten.
◆ The park (home) position is drifting, i.e. the blade parks further away from the original park site.	The coupling between the servo motor and the Micron reducer has slipped.	See Checking the Motor/reducer assembly, Section 6.
	The Trantorque coupling has slipped.	Refer to the Trantorque instructions, Section 5.

PRODUCT QUALITY PROBLEMS

Look in this section when the final product does not meet standards: has strings, burrs, cracks, or is misshaped.

Symptom	Possible cause	Solution
◆ Hairs or strings.	Blade speed is too low.	Increase the blade speed or decrease the blade cut path area (blade width)
	The blade is too thick.	Excessive blade thickness can cause frictional heat. Use a thinner blade.
	The blade is wrong for the application.	Change angle of the blade attack or the blade style to decrease the cut path area.
	Material is building up on the blade and wiping off on the cut site.	Use blade lubrication (water, etc.) or change lubricants. Consider a blade wiping system.
	There are imperfections on the blade.	The cutting edge should not have grind marks, burrs or other imperfections. Check the blade and replace if necessary.
	A hole or slot in the blade cut path is causing a 'cheese grater' effect.	Change blade design.
	The extrudate is too cold.	If the extrudate is too cold, it can fracture during cutting. Raise the extrudate's temperature.

PRODUCT QUALITY PROBLEMS CONTINUED

Symptom	Possible cause	Solution
◆ Burrs at cut site.	The bushings are not providing enough support during cutting.	Change bushing design to make them more supportive.
	The bushing gap is too wide.	The bushing gap should be no more than .001-.003 inch larger than the blade. Check and adjust if necessary.
	The blade speed is too low.	Low blade speeds can cause excessive blade interruption. Increase blade speed or decrease the blade cut path area.

PRODUCT QUALITY PROBLEMS

CONTINUED

Symptom	Possible cause	Solution
◆ Cracks at cut site.	The extrudate is too cold.	If the extrudate is too cold, it can fracture or whiten during cutting. Raise the extrudate's temperature.
	The blade speed is too high.	High blade speeds can cause too much impact. Lower the blade speed.
	The bushings are not providing enough support during cutting.	Change the bushing design to make them more supportive.
	The cutting blade is too sharp.	A blade that is too sharp can fracture some materials, especially rigid PVC and nylons. Slightly dull the blade.
	If using Nylon, it may be cooling too quickly.	If nylon is cooled too quickly, its molecular structure may become unstable, leading to poor physical properties. Try more gradual cooling.

PRODUCT QUALITY PROBLEMS CONTINUED

Symptom	Possible cause	Solution
◆ Cut is not square.	The blade speed is too low.	Low blade speeds can cause excessive blade interruption. Increase blade speed or decrease the blade cut path area.
	The blade is misaligned.	Check that blade is 90 degrees relative to the bushing holder.
	The cutter bushings are not properly gapped.	If the cutter bushings are not properly gapped, the blade may be free to move with the extrudate. Check and adjust if necessary. See Appendix A.
	The knife bevel is not symmetric.	If the knife bevel is asymmetric, the blade will tend to move in the direction of the smaller bevel. Be sure that the bevel is symmetric. NOTE: You can use this to your advantage with some rigid products.
	For rigid products the puller is too close to the cutter.	There must be enough space between the puller and cutter to allow for extrudate stoppage that occurs during cutting. Allow enough space so no cut shock is detectable at the input to the belt puller with your fingernail.

REPLACING SAFETY AND PROXIMITY SWITCHES

Three safety switches are included in SC-5 Sure Cut cutters: a keyed safety switch on the knife guard, and a proximity switch on each cutter bushing. A failure in any of these switches will prevent the cutter from running.

● Safety Switch

If you suspect a problem with the keyed safety switch on the knife guard, check for loose or damaged wires. Replace the switch if wires appear to be undamaged.

● Proximity Switches

The proximity switches on the cutter bushings have LEDs that light when the bushing is sensed. If an LED does not light when the bushing is in place:

- 1** Check for loose or damaged wires.
- 2** Remove the cutter bushing and make sure the proximity switch is properly positioned, i.e. 0.010 inch from the bushing surface.
- 3** Remove the proximity switch by loosening the set screw. Test it by bringing some object close to the sensor when the power is turned on. If the LED does not light, replace the proximity switch.

CHECKING THE SERVO AMPLIFIER

The servo amplifier is equipped with a digital readout that can be seen through the viewing window on the electrical enclosure. This display shows amplifier status and error messages. Refer to the supplier's documentation included with this User Guide.

NOTE: Make sure you look for servo amplifier messages before you shut off the power.



CAUTION: Insure that all personnel involved in the installation, operation and maintenance of this particular cutting machine, as well as those persons who will act as supervisory personnel, have read and fully understand these instructions and those contained in any and all accompanying suppliers manuals and instruction sheets before attempting to install, operate or perform maintenance on this machine.

The home position proximity switch should be 0.010 inch from the 5/16 inch thread rod on the cutter head for proper operation.

ADJUSTING THE PROXIMITY SWITCHES

- 1 Open the flywheel clear guard window.**
- 2 Locate the 5/16 inch thread rod on the cutter head.** It should be 0.010 inch from the proximity switch sensor when it passes that location. If necessary, loosen the jam nuts, readjust the distance, and re-tighten the jam nuts.



DANGER: Sharp blades!

Always wear cut-resistant gloves when the cutting chamber is open and when handling blades. Never open cutting chamber without locking out the cutter power.



Most injuries caused by knife blades occur when the cutter has been turned off. Handle blades with care at all times.

- 3 If the proximity switch does not sense** the cutter head after this adjustment, remove the switch and test it outside the cutter. Replace if necessary.

CHECKING THE ENCODER

When the encoder is working properly, the encoder LEDs on the control panel light or flicker as the encoder wheel moves and generates signals. If the LEDs do not light when the encoder wheel moves:

- 1 Check all connections.**
- 2 Check the encoder cable for damage.** If necessary, replace.
- 3 Check the connector that attaches the cable to the encoder.** Internal wiring may be shorted out if this connector is not handled properly.
- 4 Check the encoder itself.** There should be no play in the shaft.



WARNING: Delicate equipment

The encoder is a delicate piece of equipment. Any rough handling can damage fragile parts.

- 5 If all else fails,** contact Conair Customer Service. See Appendix A.

Continued

Encoder Mounting and General Information

CHECKING THE ENCODER CONTINUED

The provided encoder is a precision instrument which outputs 3000 bi-directional quadrature pulses per revolution of the shaft.

Do not apply excessive axial or radial thrust on encoder shaft (rated for 30lbs. axial thrust).

Do not press or dive gears or pinions on the encoder shaft.

Encoders are an instrument containing an accurately positioned electronic system. Dropping will cause damage as the inner disc is made of glass and is easily damaged.

Parts should slide freely on the shaft prior to securing with a clamp or set screw. (.001 slide fit).

Excessive clearance in mounting hole can lead to inaccuracy.

If encoder is taken apart, the warranty is invalidated. (seal broken)

Encoder wheel should not exceed .001 TIR.

If mounting encoder and wheel assembly on belt or roller:

- Tighten bracket to facilitate no vertical movement.
- Apply encoder wheel to surface to be measured in position that will not allow slippage, but confirms to above warnings.

Alternatives to above mounting of encoder:

- Direct drive through solid (precision board) coupling to encoder on output side of any type gear box to remove error due to backlash in gears.
- Use O-ring as a drive belt from belt sheave to encoder wheel. (Items must be machined on mandrels or actual mounting shafts to facilitate precision TIR to obtain best accuracy.)

CHECKING THE MOTOR/REDUCER ASSEMBLY

- 1** Open the flywheel clear guard window.
- 2** Remove the cutter head by loosening the Trantorque assembly. Refer to the manufacturer's guide included with this User Guide for information about the Trantorque assembly.
- 3** Locate the four bolts holding the motor/reducer assembly to the cutter. Remove them and carefully remove the assembly from the cutter.
- 4** Refer to the Micron installation and maintenance information included with this User Guide to check and adjust the motor/reducer assembly. *Refer to section 5, Installation and Removal Instructions for B-Loc.*

TESTING REPEATABILITY

Before any Conair puller/cutters are shipped, they are tested for cut time repeatability to be sure they are within performance specifications. The repeatability test checks the performance of the rotary knife cutter to return the home park position after a complete cut. Acceptable repeatability times allowed for each cutter model prior to shipping are:

Type of Cutter	Repeatability Time
AC Pneumatic Cutter	Less than 1 millisecond
DC Pneumatic Cutter	Less than 1.5 millisecond
Positional Servo (FX)	Less than 0.1 millisecond

Note: 1-millisecond at 60 feet per minute is equal to .012 inches.

The repeatability mode is built into the Conair cutter controls and allows you to perform similar tests, without any external test equipment. It is recommended that you check repeatability on a regular basis. Acceleration/deceleration delays of the servo do not contribute to repeatability error; any error is attributed solely to motor stability, couplings, assembly, power, and proximity sensor alignment.

Use any blade speed and line speed. The line speed is only seen while in the Encoder or Product modes. It is recommended that the tests be performed at cut intervals between 0.5 and 5-seconds. Do not change the blade speed or the line speed after starting the test.

To test repeatability:

- 1 Turn on the cutter.** Performing the test with the cutter off-line shows problems with the cutter; performing the test with the cutter on-line shows a problem with the puller.
- 2 Place the cutter in any mode except follower mode.**
- 3 Press the Cut On/Off button;** the cutter is activated automatically.
- 4 Press and hold the Move Right button** for a minimum of 5 seconds. 
- 5 Read the results on the display.**

Repeat the test by pressing the Reset/Test Cut button to begin a new sample period.

To end the Repeatability test, press any button except the Reset/Test Cut button. The LED returns to its normal display.

Conair has made the largest investment in customer support in the plastics industry. Our service experts are available to help with any problem you might have installing and operating your equipment. Your Conair sales representative also can help analyze the nature of your problem, assuring that it did not result from misapplication or improper use.

WE'RE HERE TO HELP

To contact Customer Service personnel, call:



From outside the United States, call: 814-437-6861

HOW TO CONTACT CUSTOMER SERVICE

You can commission Conair service personnel to provide on-site service by contacting the Customer Service Department. Standard rates include an on-site hourly rate, with a one-day minimum plus expenses.

If you do have a problem, please complete the following checklist before calling Conair:

- Make sure you have all model, serial and parts list numbers for your particular equipment. Service personnel will need this information to assist you.
- Make sure power is supplied to the equipment.
- Make sure that all connectors and wires within and between the cutter and related components have been installed correctly.
- Check the troubleshooting guide of this manual for a solution.
- Thoroughly examine the instruction manual(s) for associated equipment, especially controls. Each manual may have its own troubleshooting guide to help you.
- Check that the equipment has been operated as described in this manual.
- Check accompanying schematic drawings for information on special considerations.

BEFORE YOU CALL ...

Additional manuals and prints for your Conair equipment may be ordered through the Customer Service or Parts Departments for a nominal fee.

EQUIPMENT GUARANTEE

Conair guarantees the machinery and equipment on this order, for a period as defined in the quotation from date of shipment, against defects in material and workmanship under the normal use and service for which it was recommended (except for parts that are typically replaced after normal usage, such as filters, liner plates, etc.). Conair's guarantee is limited to replacing, at our option, the part or parts determined by us to be defective after examination. The customer assumes the cost of transportation of the part or parts to and from the factory.

PERFORMANCE WARRANTY

Conair warrants that this equipment will perform at or above the ratings stated in specific quotations covering the equipment or as detailed in engineering specifications, provided the equipment is applied, installed, operated and maintained in the recommended manner as outlined in our quotation or specifications.

Should performance not meet warranted levels, Conair at its discretion will exercise one of the following options:

- Inspect the equipment and perform alterations or adjustments to satisfy performance claims. (Charges for such inspections and corrections will be waived unless failure to meet warranty is due to misapplication, improper installation, poor maintenance practices or improper operation.)
- Replace the original equipment with other Conair equipment that will meet original performance claims at no extra cost to the customer.
- Refund the invoiced cost to the customer. Credit is subject to prior notice by the customer at which time a Return Goods Authorization Number (RGA) will be issued by Conair's Service Department. Returned equipment must be well crated and in proper operating condition, including all parts. Returns must be prepaid.

Purchaser must notify Conair in writing of any claim and provide a customer receipt and other evidence that a claim is being made.

WARRANTY LIMITATIONS

Except for the Equipment Guarantee and Performance Warranty stated above, Conair disclaims all other warranties with respect to the equipment, express or implied, arising by operation of law, course of dealing, usage of trade or otherwise, including but not limited to the implied warranties of merchantability and fitness for a particular purpose.

CUTTER BLADE SELECTION AND USE

Cutter blade characteristics such as material, design, and thickness can have a large effect on cut quality.

Blade materials

Blue tempered spring steel is most commonly used because of its cost and availability over a wide range of thicknesses (0.010-0.062 inch). It is a very tough material with an HRC value of approximately 48-51 and fair wear characteristics.

Razor blade stainless steel is becoming very popular due to its HRC value of 57-58, which leads to improved wear resistance. This material retains good toughness, but will chip or break. It is available in 0.010-0.062 inch thicknesses. Because it is non-corrosive, stainless steel is a good choice for medical cutting applications, and may even be coated with Teflon to enhance cut quality.

A-2 is a good grade of tool steel with an HRC of 60. Its minimum thickness (0.031 inch) forces the blade manufacturer to grind it down for thinner applications, which adds cost. A-2 is more wear resistant than stainless, but is also more brittle.

M-2 is an excellent grade of tool steel with an HRC of 63-66. It is one of the best materials for coating with titanium nitride for improved wear resistance. (However, coatings generally cause some slight loss of sharpness.) 0.025 inch material is available, which covers many applications without the need for secondary grinding operations.

D-2 is another excellent tool steel with an HRC range of 58-60. It is tougher than M-2 but has slightly less wear resistance. Its minimum thickness (0.035 inch) and the need for specialized grinding materials, make it a relatively expensive material. It is the material of choice for cutting Kevlar-reinforced hose.

CPM 10-V is a form of carbide developed especially for the high speed punch industry. With an HRC of 60-62 and a toughness that far exceeds D-2, it is by far the best cutting blade material. Because its minimum thickness is 0.035 inch, and it requires the use of diamond grinding wheels, CPM 10-V is the most expensive of the blade materials.

CUTTER BLADE SELECTION AND USE

Blade Design

Straight-edge knives have a straight cutting surface. A chopping action (which has cutting forces parallel to the cut) is typically obtained with straight-edge blades.

Because the blade is mounted on a rotary arm, some slicing action (which has additional force vectors at various angles to the cutting edge) is obtained, but generally not through the entire cutting action. If a slicing action is required, the angle of attack can be modified by mounting the blade on a 30-45 degree angle as close to the cut site as possible. In many cases the bushings must be modified to allow the blade holder to have close proximity to the cut site. This offers the steepest angle of attack throughout the entire cutting process. Generally straight knives can be obtained in thicknesses from 0.004-0.060 inch depending on the application.

Curved-edge knives offer increased slicing throughout the entire cutting action. They are generally used for cutting rubber preforms, rubber hose, flexible foams, and other materials that require slicing. Blade lubrication is often used to enhance the cut and minimize blade and bushing buildup.

As a general rule, curved-edge knives offer improved cut quality on rigid materials if additional heat can be used. However if used on cold rigid materials, curved knives have a tendency to produce wavy or angled cuts.

A curved edge knife can sometimes cut larger cross section profiles and tubing with the same horse power as a straight edge blade. However, the use of a curved blade increases product interruption. To overcome this effect, use a variable speed rotary knife cutter to vary the blade speed to obtain the desired cut quality.

Piercing blade (bat-wing, woodpecker) knives are specifically designed for cutting thin wall tubing. Their shape minimizes penetration marks caused by the flattening action of the blade prior to penetration of the extrudate. These are the most expensive type of blade, and the most susceptible to breakage. Because the point is exposed and not fully supported by the bushings, it may deflect into the bottom of the bushing bore and break off. For these reasons, piercing blade knives are usually used as a last resort.

Some rigid materials require warming when this type of blade is used because the impact of the point can cause cracking or whitening.

CUTTER BLADE SELECTION AND USE

Blade thickness

Because material is displaced rather than removed in rotary knife cutting, think of the blade as a wedge. The thicker the blade, the greater the displacement. This displacement can cause fracture in rigid profiles and tubing, which is often observed as a whitening on all or a portion of the cut. You can reduce this fracturing by reducing the thickness of the blade.

(This effect can also be minimized by heating the profile or tube. However, if heat is used to enhance cut quality, the bushings must be supportive enough to minimize distortion.)

If the cutting blade is too thin, it may actually deflect within the bushing bore. This can lead to "S" shaped cuts or premature blade breakage.

Optimizing blade speed

Flexible extrudates generally require a very fast blade speed with a slicing action for best results. This is due to the fact that even minimal interruption can cause a blade jam on a product that has little or no internal strength.

On the other hand, rigid extrudates may require different blade speeds to obtain the desired cut quality. What's needed for a particular application depends on blade style, internal heat, and blade thickness. Speeds as slow as 300 rpm may be required if a curved blade is used with little or no heat.

Improving cut quality by adding heat to certain materials

All rigid extrudates can have their cut quality improved by the addition of heat. A few of the most common materials and the respective temperatures are listed below:

Rigid PVC	110°-125° F
Styrene ABS	120°-135° F
Polypropylene	160°-200° F

It is important to remember that as the temperature approaches the glassification zone, the degree of support offered by the bushing becomes more important.

CUTTER BLADE SELECTION AND USE

Calculating Blade Interruption

Blade interruption is the length of time which the blade interrupts the extrudate during the cutting process. Knowing blade interruption allows you to optimize blade speed and design for specific applications.

You can calculate blade interruption for your application if you know:

- the cutting blade width
- blade speed (cutter rpm)
- extrudate cross section

The rotary knife cut path circumference is fixed for each cutter model:

SC-5 Sure Cut Model	Bushing Diameter	Knife Cut Path Diameter	Knife Cut Path Circumference
5	2.25"	28"	87.9"
	3.25"	29"	91.1"
	4.25"	30"	94.2"
	5.25"	31"	97.3"
	2"x4"	28"	87.9"
	2"x6"	28"	87.9"
	2"x8"	28"	87.9"
	2"x10"	28"	87.9"
	3"x6"	29"	91.1"
	4"x7"	30"	94.2"

As an example, calculate the blade interruption (in milliseconds) for an SC-5 cutter running 1/4 inch (0.250 inch) OD tubing. The blade speed is 718 rpm and the cutting blade is 15/16 inch (0.937 inch) width at the point where it passes through the extrudate, and the cut path circumference is 87.9" for the SC-5.

Calculate the blade interruption time. The interruption time starts when the blade makes its first contact with the extrudate and ends when the blade is totally clear of the product (i.e. no longer interrupting it). Because we know the blade travel speed, we can calculate the interruption time if we know how far the blade travels during period of interruption. This distance is equal to the sum of the extrudate outer diameter and the blade width at the point of contact.

$$\text{Blade interruption time, msec} = \frac{(\text{Product OD} + \text{Blade width})}{\text{Knife circumference}} \times \frac{60,000}{\text{rpm}}$$

CUTTER BLADE SELECTION AND USE

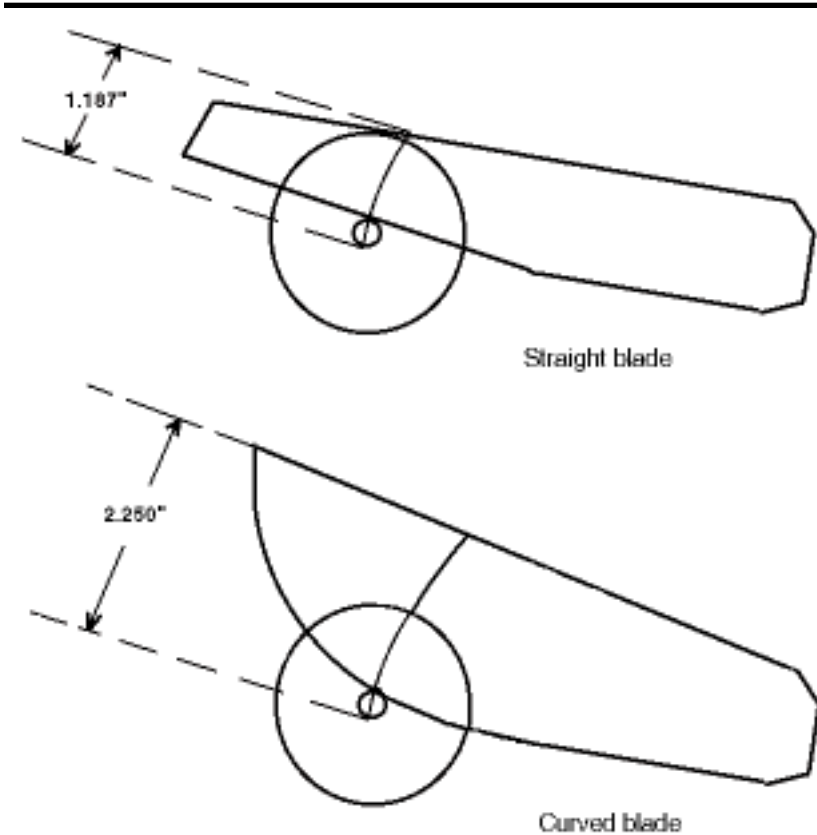

To calculate interruption time:

$$\frac{(0.937 \text{ in.} + 0.250 \text{ in.})}{87.9 \text{ in.}} \times \frac{60,000 \text{ msec/rev}}{718 \text{ rpm}} = 1.13 \text{ msec}$$

Knowing the interruption time and the line speed, you can calculate the amount of production deflection that must be accommodated during cutting. To calculate the amount of extrudate deflection between the cutter and puller, multiply line speed by interruption time:

$$\text{Blade Interruption time, msec} \times \text{Line speed, fpm} \times \frac{12}{60,000} = \text{Deflection, in.}$$

$$1.13 \text{ msec} \times 60 \text{ fpm} \times 12 = .014 \text{ in.}$$

In this example the puller and cutter must be set up to allow for 0.014 inch of product deflection during cutting. Failure to do this can lead to puller stoppage (which can form annular rings on the product), and poor-quality cuts (hairs or fuzz and angular cuts).

CONAIR CUTTER BLADES

Part No.	Blade Type	Bushing Size {inches}	Blade Thickness x Length {inches}	Blade Material
0235-30496	Straight	4 ¹ / ₄ , 5 ¹ / ₄ , 4x10	0.025x9.5	Spring Steel
3515-30496-1	Straight	2 ¹ / ₄ , 2x4, 2x6	0.025x6.48	Spring Steel
3515-30496-2	Straight	3 ¹ / ₄ , 2x8, 2x10, 2x12, 4x7	0.025x8.33	Spring Steel
3515-30488	Curved	3 ¹ / ₄ , 4x7, 3x6	0.025x11.15	Spring Steel

ALL ABOUT CUTTER BUSHINGS

Rotary knife cutter bushings are probably the most ignored aspect of cutting. Yet, they are probably the most important ingredient to obtaining clean, square, accurate cuts with minimal jamming and broken blades.

This appendix contains information about several aspects of cutter bushings:

- bore characteristics
- bushing length
- shear surface characteristics
- the bushing gap

Cutter bushing bore size

The cutter bushing bore size affects both the cutting process and the overall extrusion process.

Bushings with relatively large bores are often used to facilitate start-up and minimize bushing inventory. While this practice is acceptable for start-up, it will lead to premature blade failure because the bushings do not properly support the blade. For optimum cut quality, make sure the bore adequately supports the tube or profile.

When the blade first makes contact with the tube or profile, it pushes the part until it assumes the size and/or shape of the bushing bore. In the case of tubes this causes two marks on the tube (penetration marks) that show where the tube flattened before the blade actually penetrated it. The tighter the bushing bore size to tube size, the closer the marks become, making them less obvious.

If the bushing bore is too tight, excessive extrudate interruption or even jamming may occur. In turn, this can cause internal air blockage in free extruded flexible materials and thus extrudate size fluctuations. In the case of rigid profiles or tubes, belt puller slippage may occur during the cutting if the bushings are improperly configured. This can cause annular rings around the extrudate and size fluctuations.

- For rigid profiles or tubes, allow 0.010-0.020 inch clearance over the OD tolerance. Anything tighter than 0.010 inch will be difficult to process. For easier startup, allow as much as 1/4 inch above a rigid profile because the blade will force the profile to the bottom of the cutting bushing where the shearing action occurs. However, if perfect squareness is required, the clearance above the profile should be minimized to prevent bowing.

ALL ABOUT CUTTER BUSHINGS

Supportive bushings become more important if heat is used to minimize whitening (fracturing).

- If you are cutting a square or rectangular profile, whether rigid or flexible, a round bushing bore will not offer proper support and will often lead to an "S" shaped cut. A flat bottomed bushing will offer excellent support and enhance the shearing action of the blade.
- In the case of flexible extrudates, allow 0.010-0.050 in. clearance depending on durometer and surface; the softer durometers and tacky surfaces require the most clearance. In the case of softer durometer materials, bushing lubrication may be required to minimize drag and material build-up between the cutter bushing faces.

Cutter bushing bore surface quality

The internal surface of the cutter bushing must be smooth and glass-like when cutting flexible extrudates, otherwise excessive drag causes jamming and can lead to variations in cut-to-length accuracy.

- When cutting flexible materials, have the internal surface machined to resemble glass. In many cases, medical processors will actually have the ID of their bushings either honed or burnished for best results.
- When cutting clear extrudates, it is also very important to have a smooth internal surface to minimize scratches. In some cases it may be necessary to make a Teflon or Delrin insert to further minimize drag and/or scratching.
- Bushing lubrication can also help minimize bushing drag.
- Be sure to have a lead-in angle machined into the entrance of the upstream cutter bushing. The transition from the bore to the lead-in angle should not be abrupt as it can cause variable drag.

Cutter bushing shear surface quality

ALL ABOUT CUTTER BUSHINGS

Similar to a dull pair of scissors, if the cutter bushing shear surface is not sharp the tube or profile is not supported to the side of the blade and the cut will not be clean. In some cases, the entrance of the downstream cutter bushing is slightly radiused to minimize jamming. While this practice helps accommodate bushing bores that are not quite aligned, it has a negative effect on cut quality.

- The shear surface of both the upstream and downstream cutter bushings should be sharp and bored to the same size. NOTE: In high speed cutting applications, the downstream bushing is sometimes bored 0.005" larger than the upstream bushing to minimize jamming. Deburr the edge after the boring operation, but be careful to remove only the burr and not the edge.
- Leave a minimum land of 1/8 - 1/4" on the face of the cutter bushing beyond the bore. Angle the rest of the bushing face with a 10-15 degree lead-in.

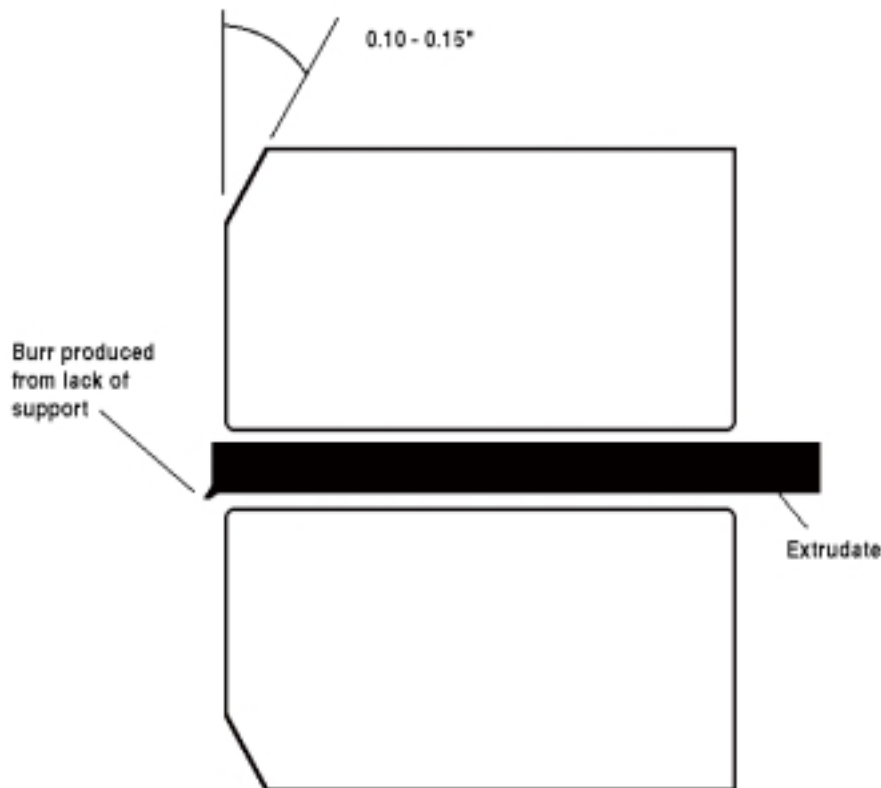

ALL ABOUT CUTTER BUSHINGS

Cutter bushing length



CAUTION: Blade hazard

In order to comply with OSHA regulations, the distance from the sidewall of the cutter to the blade (through the bushing) must be long enough to prevent fingers from reaching the blade.

On flexible extrudates, it is important to minimize the length of the cutter bushings. It is very difficult to push flexible extrudates through since it tends to compress as it is pushed, causing a marginal increase in the tube diameter. For this reason, bushing lubrication may be necessary to minimize drag as the length of the bushings increase. A discharge conveyor may also be helpful in removing longer cut parts. The exit bushing may be funneled to allow the cut part to drop out faster while still maintaining minimal bushing length for safety.

- For flexibles, the upstream cutter bushing should offer total support to the extrudate as close to the nip point of the puller as possible. In this way the part is not able to move from side to side or bow from the weight of the tube, which can, in turn, cause variable drag. You use the strength of the tube to push itself.
- The bore length of the exit bushing should not be shorter than $1\frac{1}{2}$ times the diameter of the tube with the remainder of the bushing length being tapered. On sticky flexible extrudates, the parts will actually stick back together if the new part has to push the cut part out very far.

For rigid extrudates, the length of the cutter bushings can result in a square cut or an angular cut. The cutter bushings support the extrudate keeping it from moving from side to side and bowing from the weight of the profile itself. Many processors make their bushings short to minimize cost of EDM which is determined by depth of cut.

- For rigid extrudates, a general rule is to make the length of the cutting bushings equal to two times the largest outside dimension. NOTE: In the case of full profile cutter bushings where maximum support is offered, the bushing length may be shortened depending on actual clearance.
- Be sure to have a lead-in angle machined into the entrance of the upstream cutter bushing. The transition from the bore to the lead-in angle should not be abrupt as it can cause variable drag.

Adjusting the cutter bushing gap

If the bushing gap is too big, material is dragged down between the bushings creating a burr, especially with flexibles. This may lead to jamming within the bushings where the upstream side of the cut extrudate actually hits against the downstream bushing surface. This is especially apparent with flexibles with non-concentric walls where a slight bow is present.

- Locate the downstream bushing such that it touches the blade without deflecting it. Lock it in place and rotate the blade to check proper gap.
- Locate the upstream cutter bushing with 0.001-0.002 inch of the blade and lock it in place. Rotate the blade through the set bushings to insure proper gap. NOTE: Because blades are rarely perfectly flat, it is possible that a swishing sound will be heard.
- If hairs are present on only the upstream cut end of a tube or profile, it may be necessary to allow a 0.002-0.005 inch gap on the downstream bushing to allow the blade to slightly move with the extrudate during the cutting cycle and not cause excessive frictional heat which actually melts the extrudate. NOTE: Blade/bushing lubrication can also help to solve this problem.

ALL ABOUT CUTTER BUSHINGS

BLADE AND BUSHING LUBRICATION

Blade and bushing lubrication can nearly always improve the quality of cutting.

Description of the cutting process

Unlike sawing, a rotary knife cutter displaces material rather than removing it. When the knife blade first contacts the extrudate, it pushes it against the opposite side of the cutter bushings. If there is too much clearance the extrudate may crack or distort before cutting even begins. Tubing may develop two distinctive marks related to the compression of the tube.

Once the blade penetrates the part, material is displaced to either side of the blade. This displacement will vary in degree and visibility depending on the type of material, temperature, blade thickness, blade style, and blade speed. As the material is displaced, heat is generated and passed to the blade surface.

Flexible materials (flexible PVC, urethanes, and even LDPE) will generally compress during cutting, leaving little or no sign of displacement. The cut will appear uniformly glossy and free of fracture. However, a closer look will show very fine lines on the cut face. With flexible materials, these lines will typically show an arc or "S" pattern which can be attributed to compression of the part as the blade passed through.

Rigid materials such as rigid PVC and styrene will tend to fracture during cutting. The cut surface changes from glossy to dull, and finally becomes whitened and rough. Whitening occurs when cutting changes to fracturing: the cut begins to extend in front of the cutting blade, which acts as a wedge. At this point, you can only hope the fracture is controlled, allowing for a square cut.

Friction and heat during cutting

Because most rotary knife cutters don't travel with the flow of the extrusion line, forward motion is interrupted as the blade passes through the plastic tube or profile. This interruption causes friction, which generates heat in the cutting blade. As the temperature of the blade increases, plastic is melted at the cut site. This melted plastic can adhere to and coat the cutting blade, especially on the upstream side, and be transferred to the next part in the form of hairs or tissue-like film. This will be especially noticeable on the top inside of the tube or profile.

Common cutting lubricants

Commonly used general purpose lubricants include:

- Tap water
- Dish washing liquid (Joy, etc)
- Glycol (anti-freeze, coolant)
- Water-soluble silicone cutting oils
- Diesel fuel
- Mold release
- Mineral oil

Medical grade lubricants:

- Distilled water
- Isopropanol (isopropyl alcohol)
- Mixtures of isopropanol and water

Lubrication systems

The most basic blade lubrication system for rotary knife cutters is using a stainless steel tray filled with the lubricant. Because the cutting blade passes through the tray during every cutting cycle, the blade is lubricated before each cut. This approach limits material buildup on blade and bushing surfaces for most applications. Care must be taken to maintain the lubricant level within the tray and clean out accumulated cut residue on a regular basis.

Spray mist systems can be used to lubricate either the blade or the extrudate as it enters the cutter bushings. These systems allow the application of a minimum amount of lubricant with good consistency. If the mist is applied to the product as it enters the cutter bushings, the lubricant will minimize the drag between the bushing bore and the tube or profile, as well as wet the blade and bushing faces. With flexible and/or sticky materials this can improve both cut quality and cut-to-length accuracy.

The last method of blade lubrication (and the oldest) is the blade wipe system. Felt, sponge, or some other absorbent material is mounted so the rotary knife blade will pass through it, with interference, before making a cut. Typically a gravity drip or wick system is used to keep the absorbent material wet with lubricant. These systems not only lubricate the blade, but also wipe off residue before each cut. However, the operator must constantly observe the condition of the pads as they wear quickly and lose their function. Another concern (especially in medical applications) is what happens to wear particles from the pads. This material frequently ends up on the blade itself, and is then transferred to the very product it is meant to protect from contamination.

BLADE AND BUSHING LUBRICATION

If the blade has a rough surface where the extrudate rubs against it, material will accumulate on the blade in a cheese grater fashion. This scratched material will also be passed from the blade to the next cut and be seen as hairs or flakes.

Some of the more flexible materials, such as silicones, soft urethanes and flexible PVCs, also exhibit drag against the blade during the cutting cycle. The part will actually stick to the side of the blade and drag down between the bushings. Typically a small "c" shaped tail of the tube will accumulate in the bottom of the cutting chamber. This tail actually tore off the tube rather than cut due to the excessive drag against the blade

The generation of heat during cutting can also lead to parts that stick to each other. They may appear to be welded together, and an extra operation may be required to separate them. This can be a real problem in materials such as latex, silicone, PP, and flexible PVC.

Benefits of using lubricants

The primary benefit of using a cutting lubricant is reducing friction. If the cutting blade is coated with a film of lubricant, the coefficient of friction between the blade and the plastic tube or profile is reduced, reducing the generation of frictional heat.

Lubricants also minimize the tendency for material to stick to the blade, thus minimizing the potential for material to be wiped on the next cut part. The coefficient of friction is reduced with varying degrees, depending on the type of lubricant, which in turn limits the increase in blade temperature. Over time this can lead to an increase in blade life because the cutting edge will last longer at cooler operating temperatures.

While lubricants can also help minimize problems caused by rough or poorly ground blades and cutter bushings, it is generally better to solve the problem than mask it with lubricants.

ENCODER MODE OPERATOR DISPLAY OVERVIEW

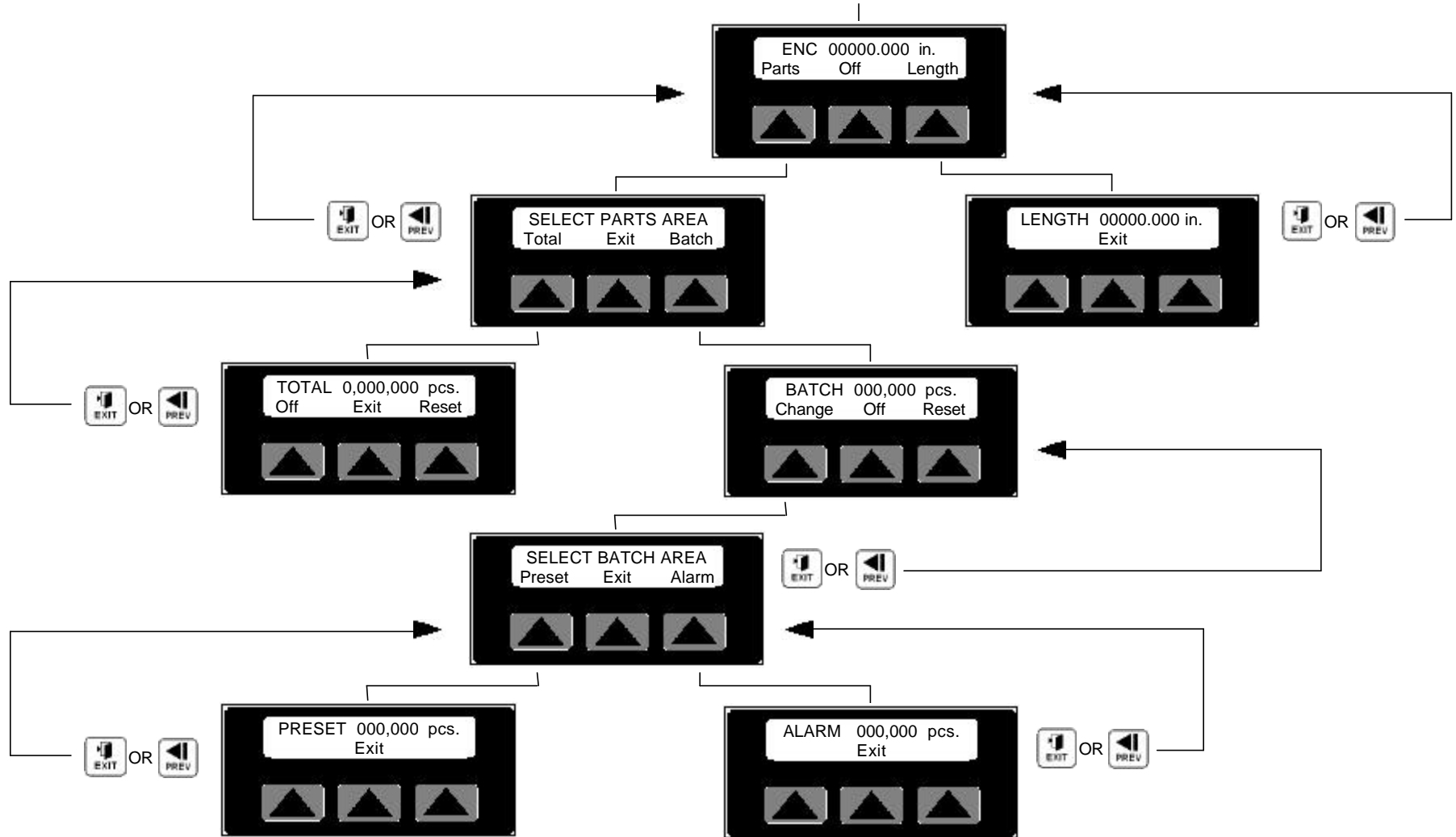

END SENSE MODE OPERATOR DISPLAY OVERVIEW

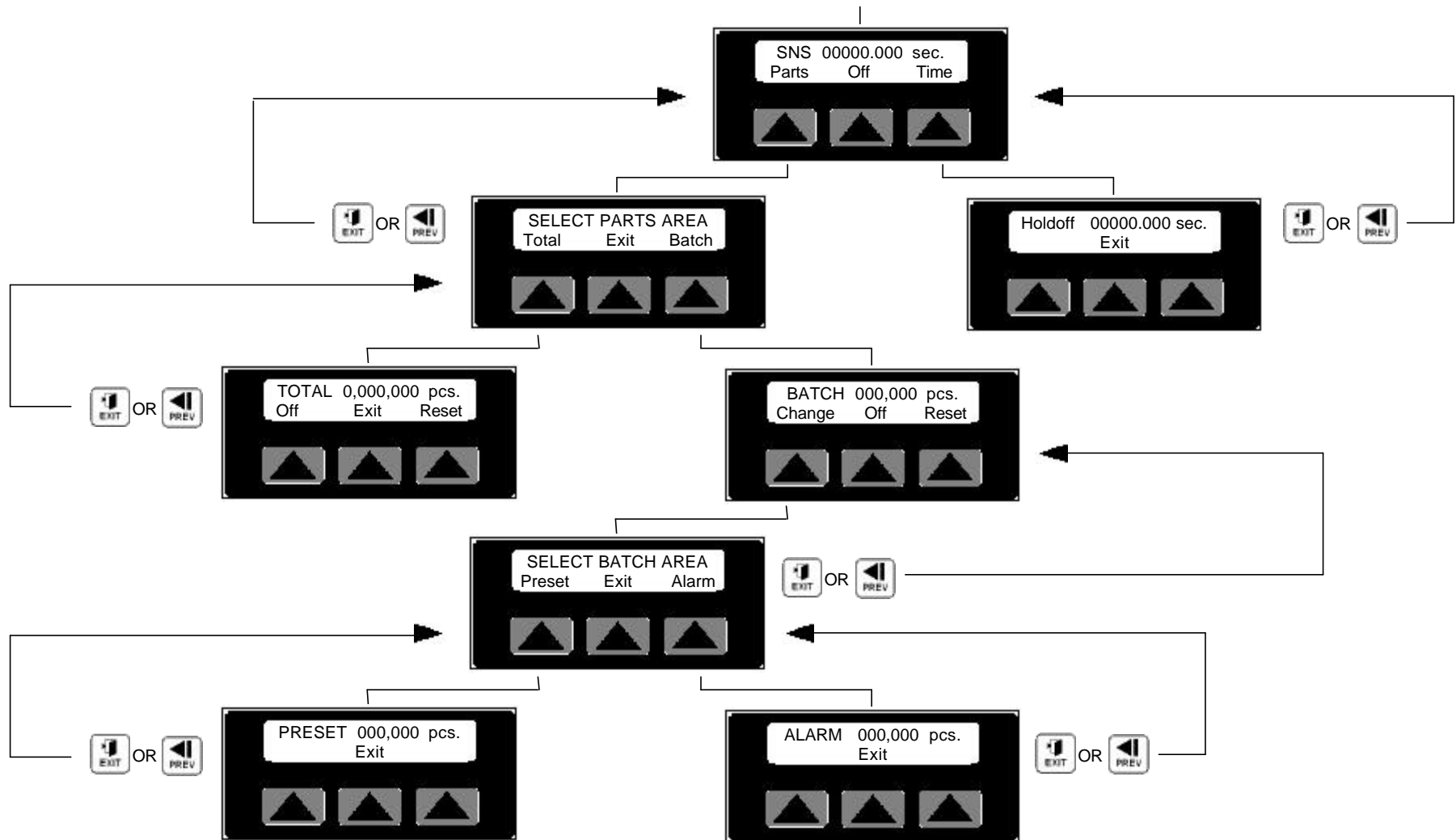

FLYWHEEL MODE OPERATOR DISPLAY OVERVIEW

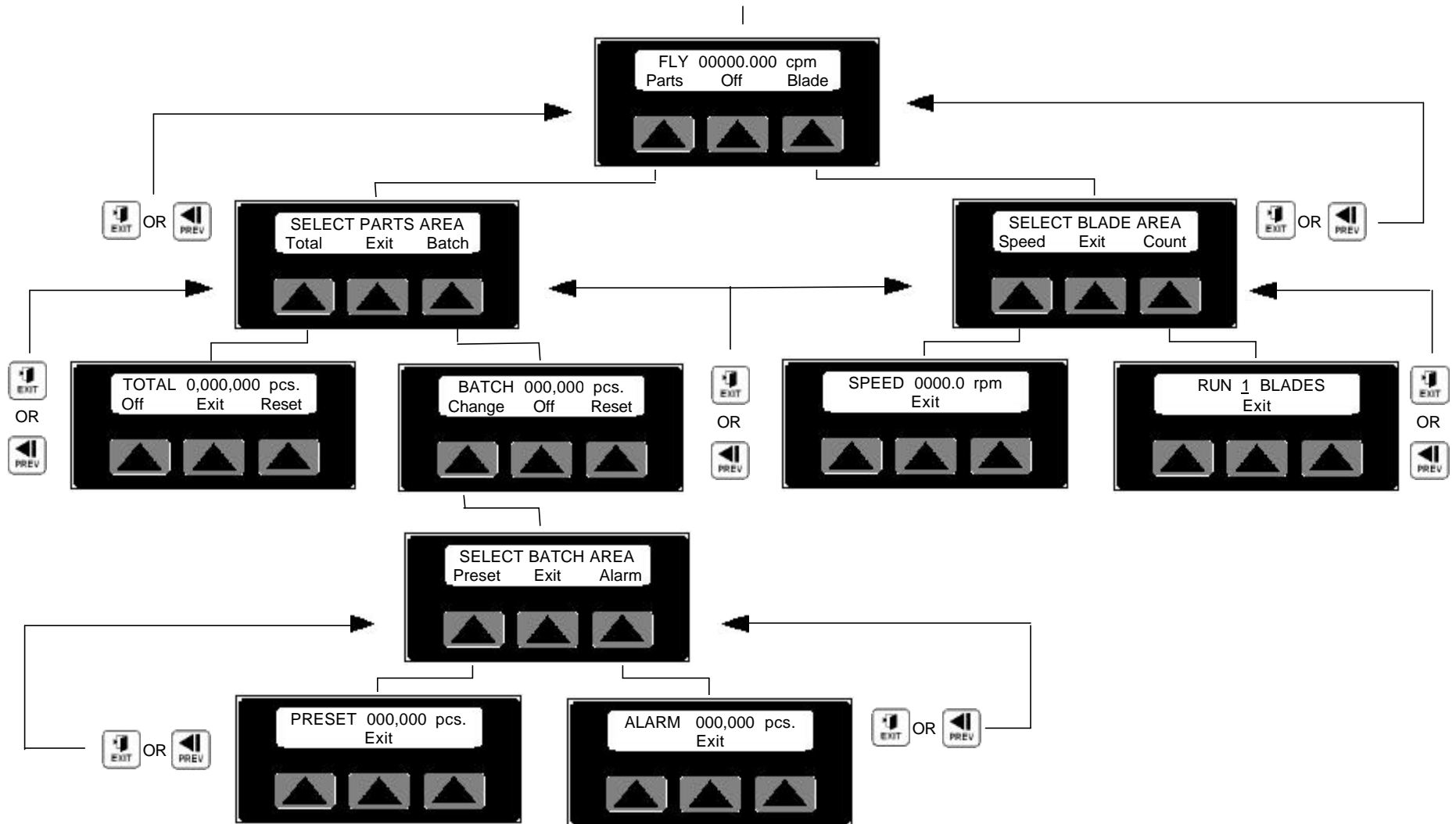

TIMER MODE OPERATOR DISPLAY OVERVIEW

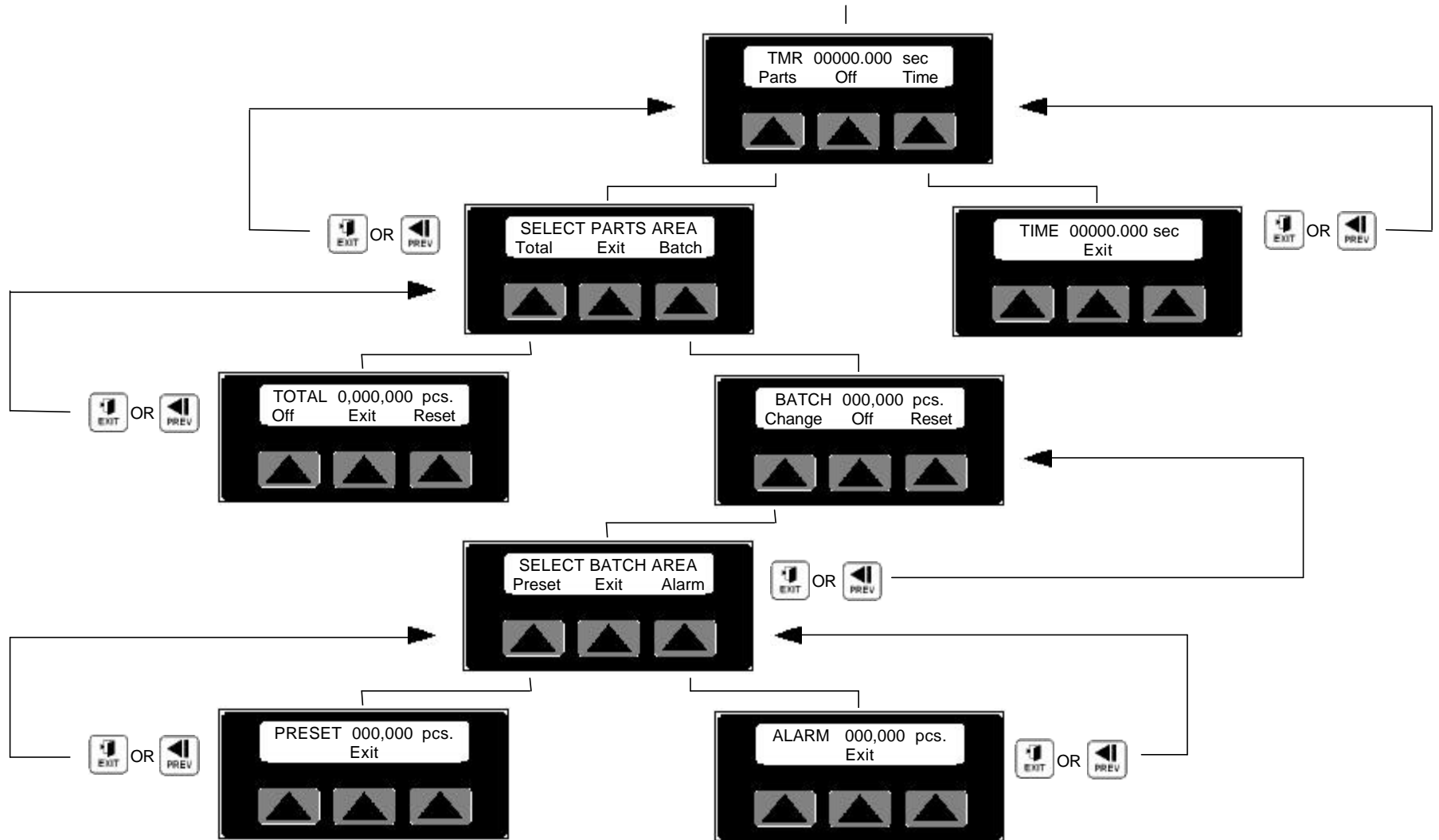

FOLLOWER MODE OPERATOR DISPLAY OVERVIEW

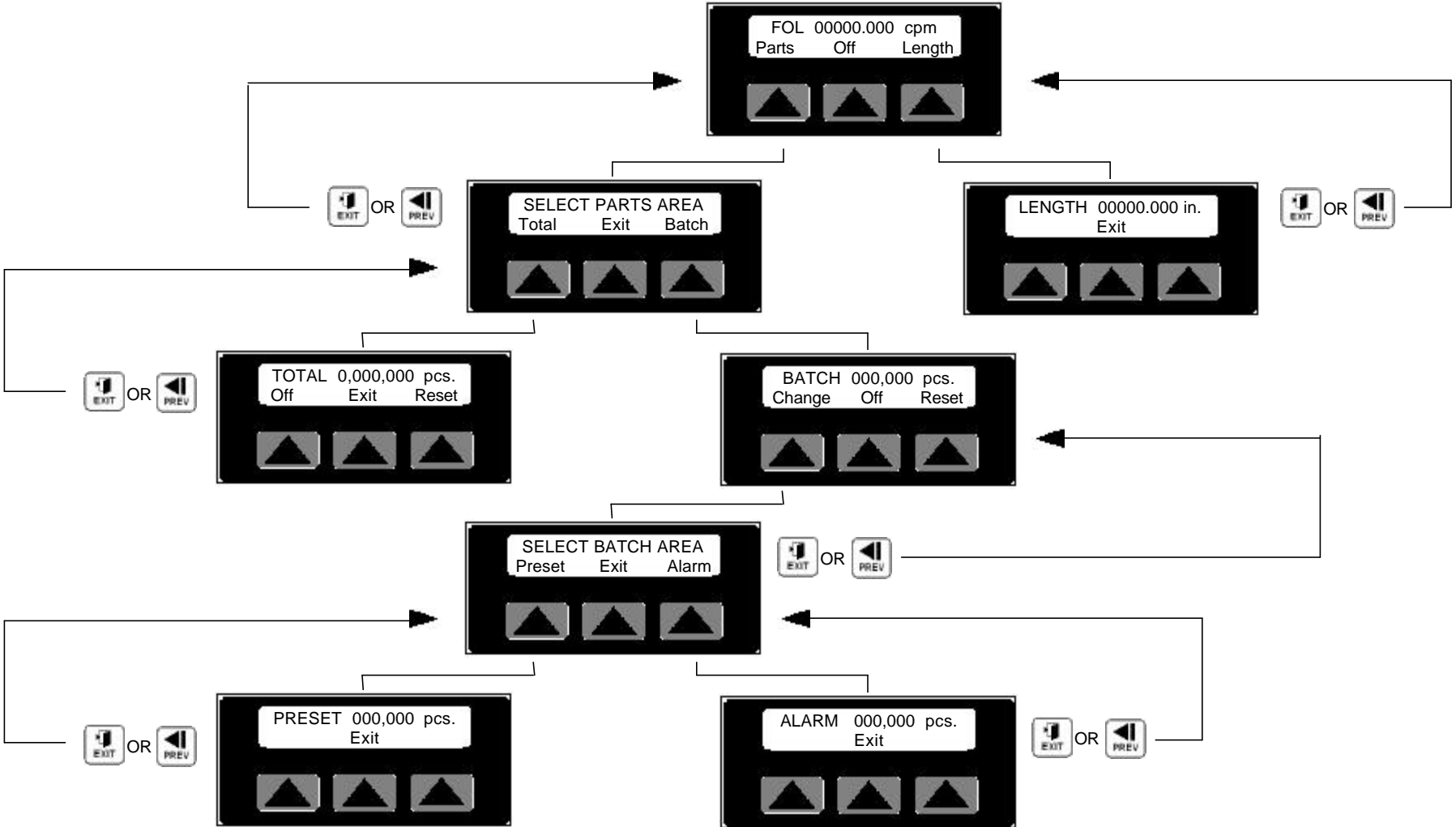

AUTO DEMAND MODE OPERATOR DISPLAY OVERVIEW

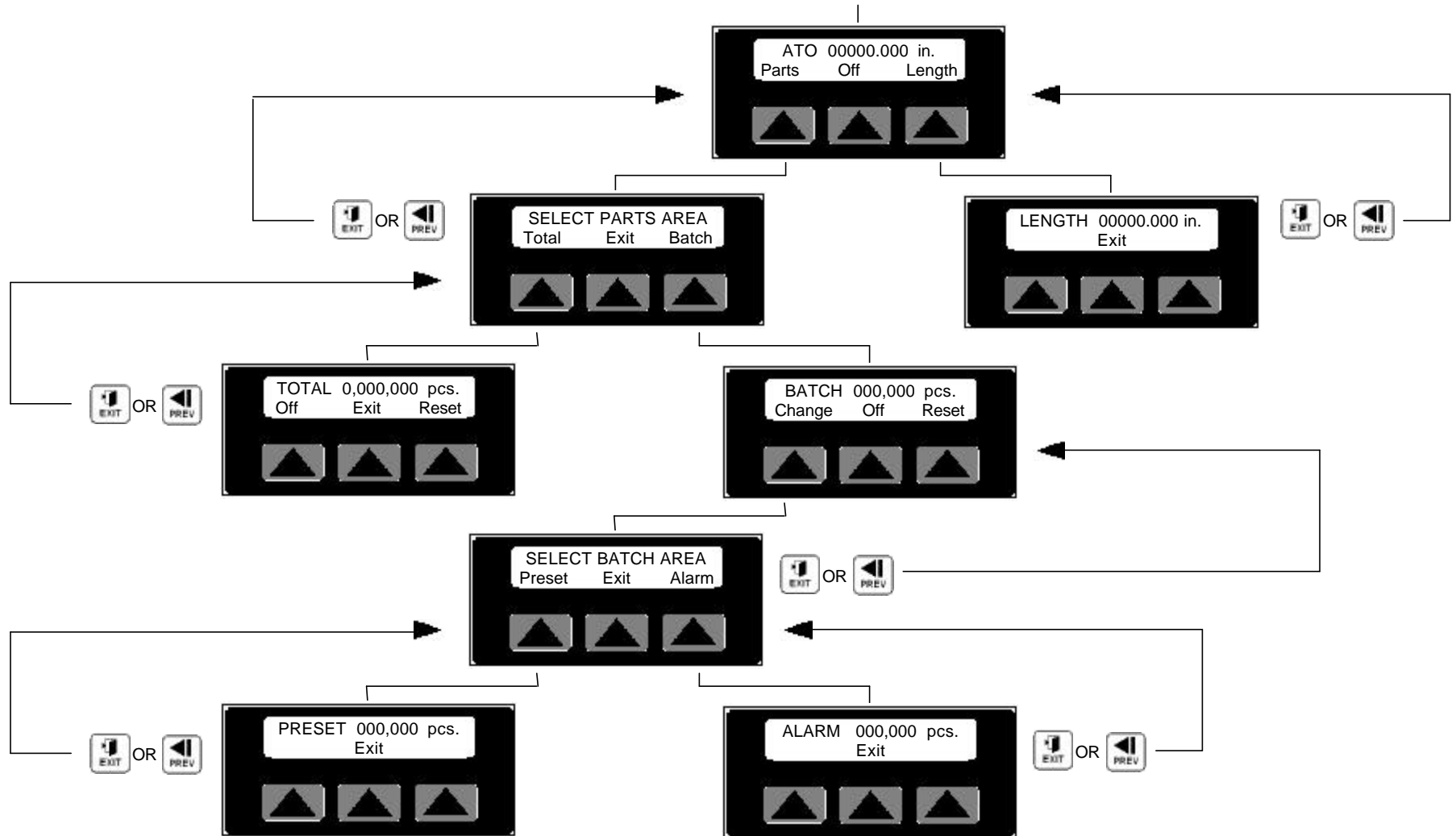

**MULTIPLE PRESETS
ENCODER MODE (EXAMPLE)
OPERATOR DISPLAY OVERVIEW**

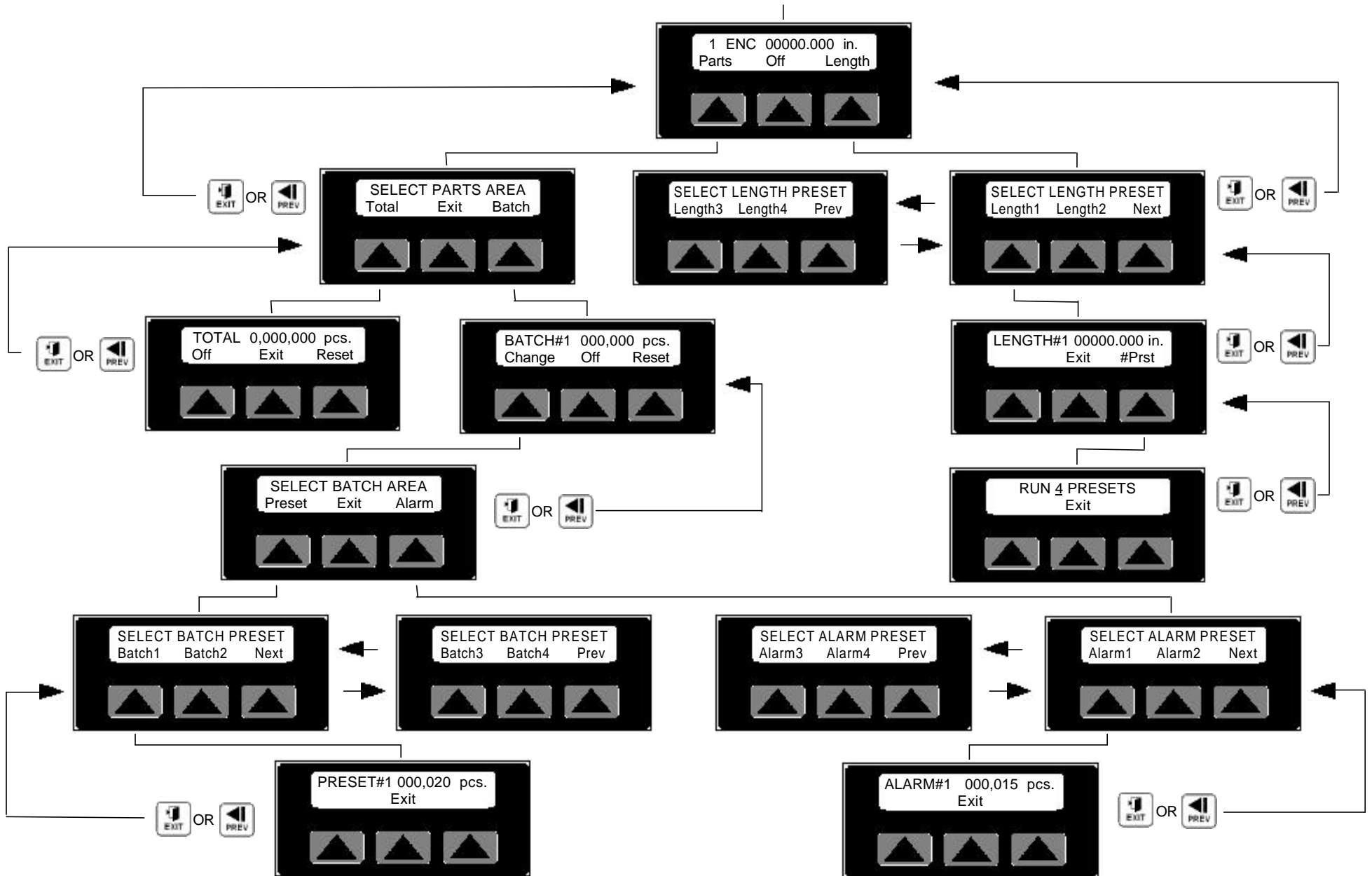

**FUNCTION AREA 1
OPERATOR DISPLAY OVERVIEW**
(accessed by pressing the menu button)

**FUNCTION AREA 2
OPERATOR DISPLAY OVERVIEW**

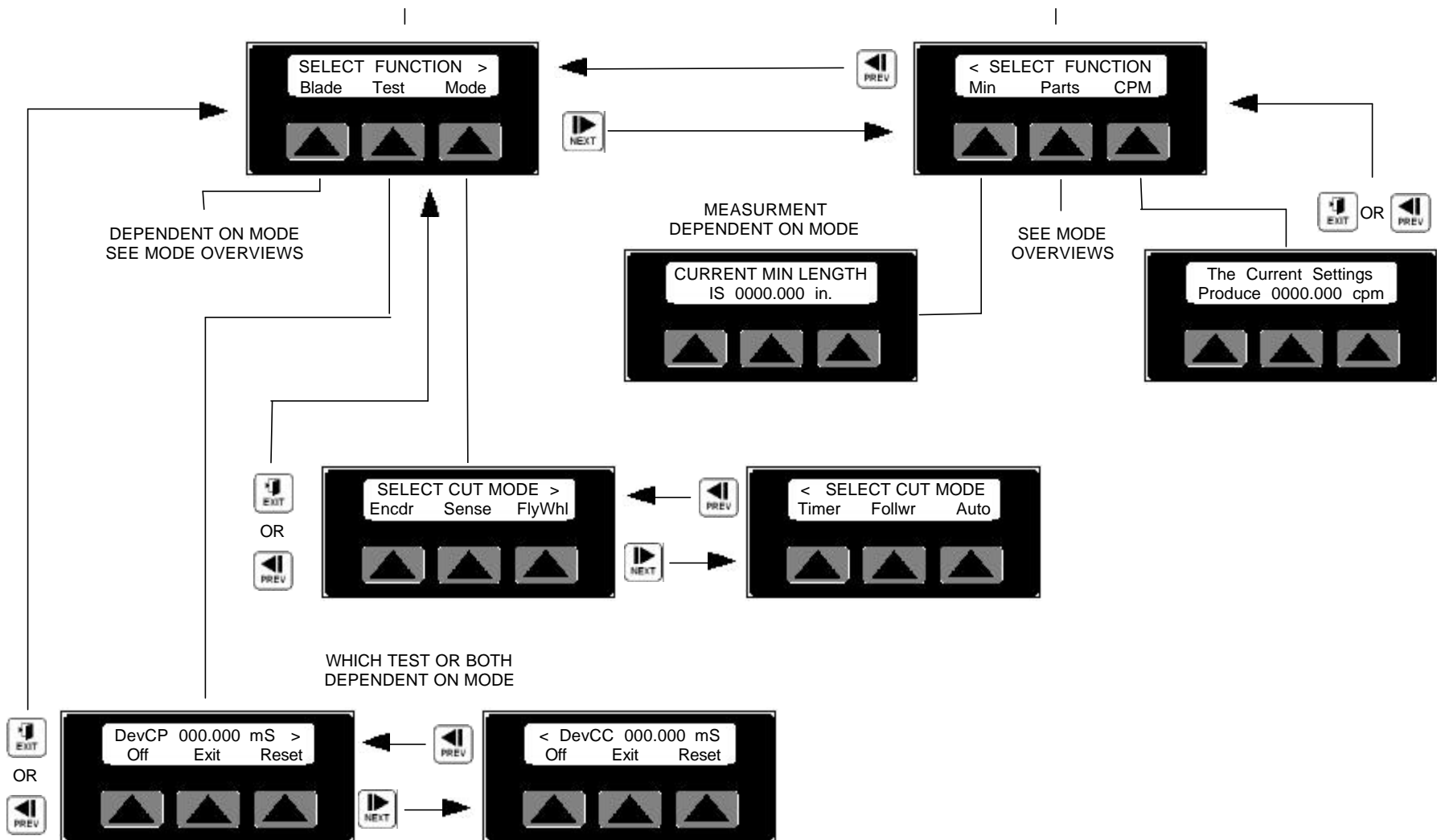

**MAINTENANCE AREA
DISPLAY OVERVIEW**
(Accessed by pressing the menu button from Menu Area #1 and entering the correct password)

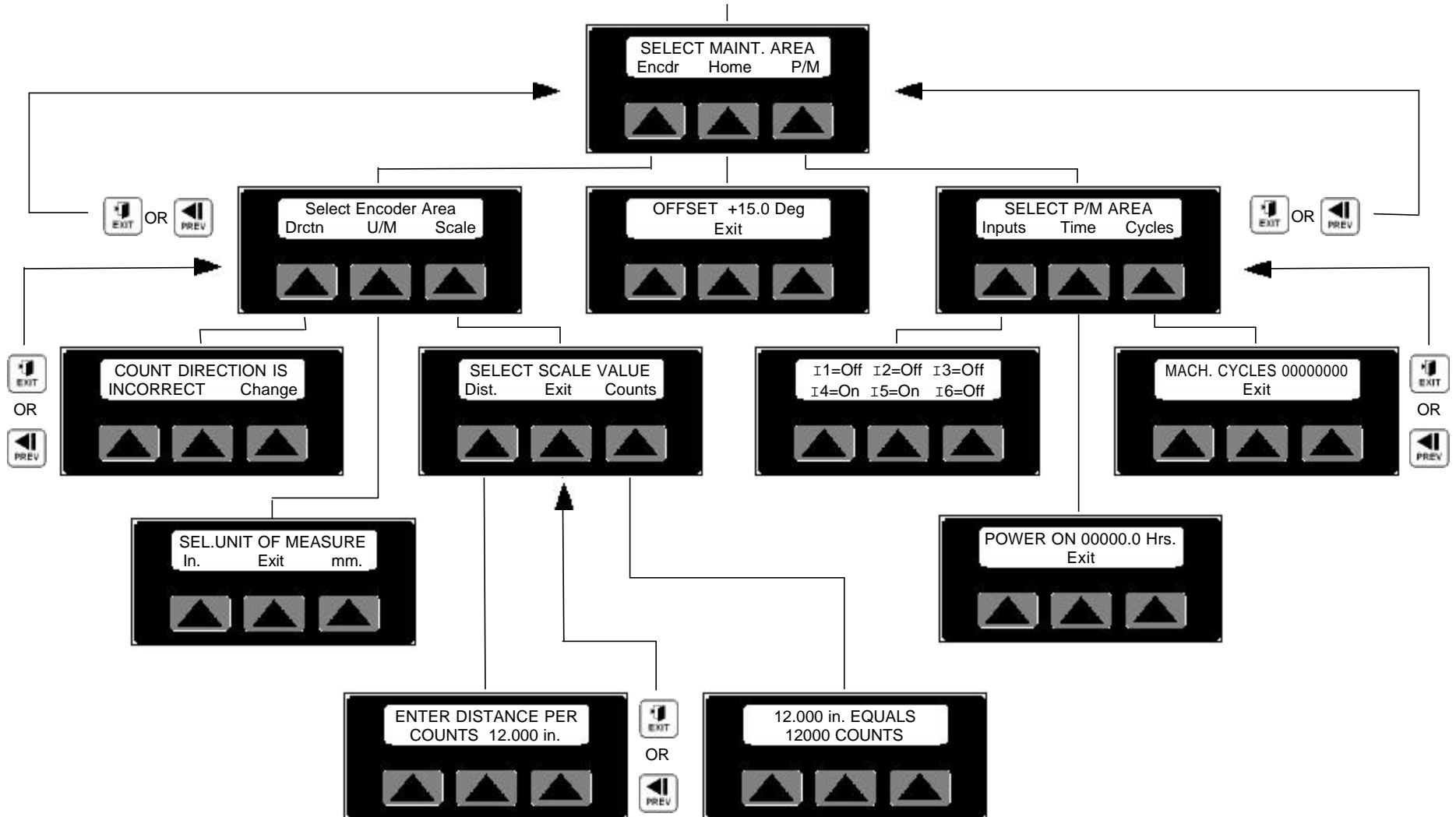

Free Manuals Download Website

<http://myh66.com>

<http://usermanuals.us>

<http://www.somanuals.com>

<http://www.4manuals.cc>

<http://www.manual-lib.com>

<http://www.404manual.com>

<http://www.luxmanual.com>

<http://aubethermostatmanual.com>

Golf course search by state

<http://golfingnear.com>

Email search by domain

<http://emailbydomain.com>

Auto manuals search

<http://auto.somanuals.com>

TV manuals search

<http://tv.somanuals.com>