

CONCORD 3132z

User's Guide



www.concord-camera.com

INDEX

| | |
|---|----------|
| Getting Started | 1 |
| Contents of Package | 1 |
| System Requirements | 1 |
| General Precautions | 2 |
| FCC Compliance and Advisory | 2 |
| Camera Nomenclature | 3 |
| Accessory Set-up | 4 |
| | |
| Preparing to Take Pictures | 6 |
| Battery Installation | 6 |
| Turning the Power On | 8 |
| Date and Time Set-Up | 9 |
| Beep Sound Set-Up | 10 |
| Quick View Setting (LCD Confirm) | 10 |
| Auto Power Off Settings | 11 |
| TV Out Signal Set-Up | 12 |
| Language Set-Up | 13 |
| Returning to Default Settings | 14 |

| | |
|---|-----------|
| Using a Memory Card | 15 |
| Camera Working Mode | 16 |
| Taking Pictures | 17 |
| Previewing a Picture before it is taken | 17 |
| Using the Zoom Feature | 19 |
| Digital Zoom Function | 19 |
| Taking a Picture | 20 |
| Changing the Picture Resolution | 22 |
| Adjusting the Exposure | 24 |
| Setting the White Balance | 25 |
| Changing the ISO Speed | 26 |
| Setting the Slow Shutter Mode | 27 |
| Setting the Flash | 28 |
| Using the Macro mode | 28 |
| Setting the Self-Timer | 29 |
| Recording Video Images | 30 |
| Functions Available in Each Shooting Mode | 32 |
| Reviewing Your Pictures and Videos | 33 |
| Viewing Pictures | 33 |

| | |
|--|-----------|
| Replaying the Last Image Quickly | 33 |
| Viewing Pictures in Thumbnail | 34 |
| Zooming the Displayed Image | 35 |
| Erasing Pictures | 35 |
| Protecting Pictures against Deletion | 38 |
| Running a Slide Show (Auto Play) | 39 |
| Copying Flash Memory Images to a Memory Card | 40 |
| Formatting Memory Card or On board memory | 41 |
| Setting Your Camera for Printing | 43 |
| Folders and Files | 43 |
| File Number Reset..... | 44 |
| DPOF Print Settings | 45 |
| PRINT Image Matching | 47 |
| Installing the Software..... | 48 |
| Installing the Drivers..... | 48 |
| Installing the Software..... | 49 |
| Using MGI PhotoSuite 4 SE..... | 51 |
| Connecting your camera..... | 54 |
| Viewing Images on a TV Set..... | 54 |

| | |
|---|----|
| Downloading Images to a Computer..... | 54 |
| About the memory storage in this camera..... | 58 |
| Indicator Lamp Reference | 59 |
| Troubleshooting | 59 |
| Default Setting in Each Camera Working Mode | 61 |
| Specification | 62 |

Getting Started

Contents of Package

All of the items shown below are included with your camera.

Camera



USB cable



Video cable



Strap



Soft case



User's Guide



CD-ROM



*Alkaline batteries
(2 AA-size batteries)*



System Requirements

For Windows

PC with processor better than MMX Pentium 166MHz
Windows 98/98se/2000/ME/XP
Minimum 32MB RAM
USB Port
CD-ROM drive

For Macintosh

Mac Power PC or higher
Mac OS 9.0 - 10.0
Minimum 32MB RAM
USB Port
CD-ROM drive
800x600 pixels, 16-bit color display compatible monitor

* Specifications are subject to change without prior notice.

General Precautions

- Do not try to open the case of the camera or attempt to modify this camera in any way. High-voltage internal components create the risk of electric shock when exposed. Maintenance and repairs should be carried out by authorized service providers.
- Do not fire the flash near eyes, human or animal. It may cause eye damage especially to children.
- Do not use this camera with wet hands. Keep the camera away from water and other liquids. Moisture creates the danger of fire and electric shock. Never use this camera in the rain or snow.
- For safety reasons, please keep this camera and accessories out of reach of children or animals to prevent accidents.
- If you notice smoke or a strange odor coming out of the camera, immediately turn the power off and unplug the AC adaptor from the power outlet. Take it to an authorized service center for repair. Never attempt your own maintenance.

FCC Compliance and Advisory

This device complies with Part 15 of the FCC Rules. Operation is subject to the following two conditions: 1.) this device may not cause harmful interference, and 2.) this device must accept any interference received, including interference that may cause undesired operation.

This equipment has been tested and found to comply with the limits for a Class B peripheral, pursuant to Part 15 of the FCC Rules. These limits are designed to provide reasonable protection against harmful interference in a residential installation. This equipment generates, uses and can radiate radio frequency energy and, if not installed and used in accordance with the instructions, may cause harmful interference to radio communication. However, there is no guarantee that interference will not occur in a particular installation. If this equipment does cause a harmful interference to radio or television reception, which can be determined by turning the equipment off and on, the user is encouraged to try to correct the interference by one or more of the following measures.

- Reorient or relocate the receiving antenna.
- Increase the separation between the equipment and receiver.
- Connect the equipment to an outlet and to a circuit different from that to which the receiver is connected.
- Consult the dealer or an experienced radio/TV technician for help.

Any changes or modifications not expressly approved by the party responsible for compliance could void the user's authority to operate the equipment. Where shielded interface cables

have been provided with the product or specified additional components or accessories elsewhere defined to be used with the installation of the product, they must be used in order to ensure compliance with FCC regulation.

Camera Nomenclature

Front

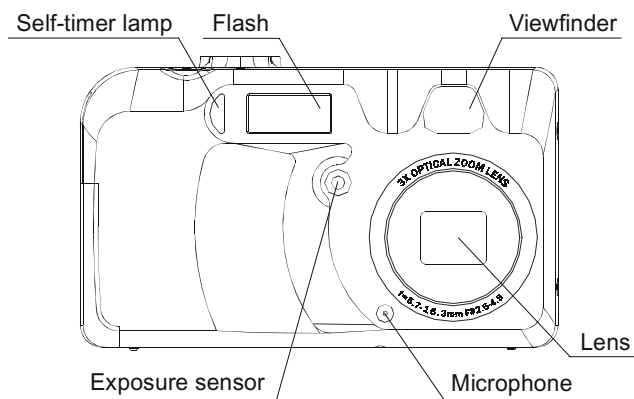

Back

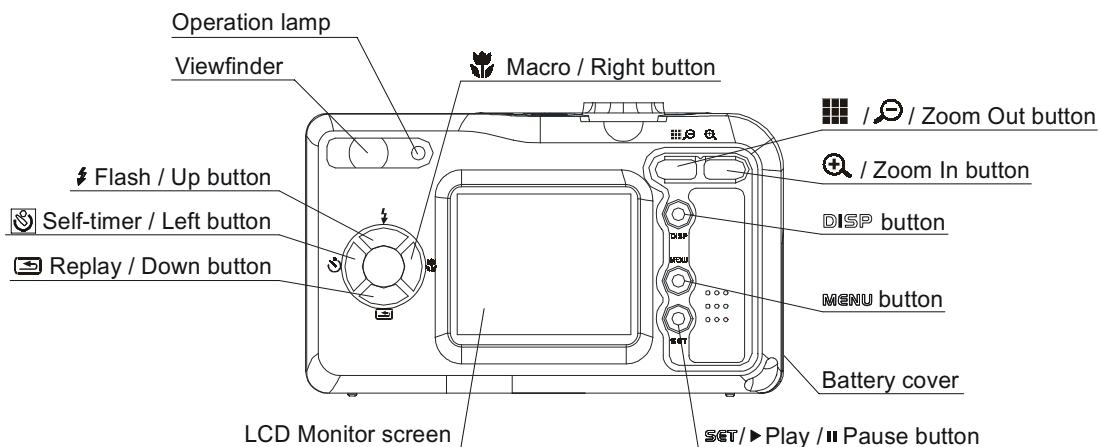

Side

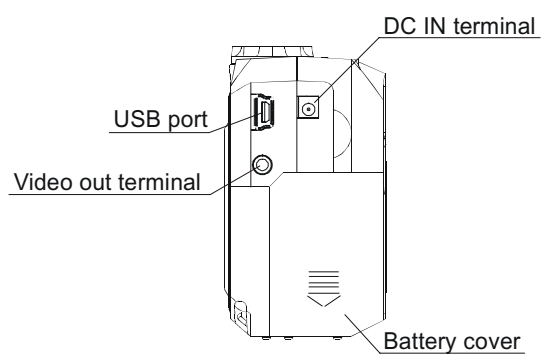

Top

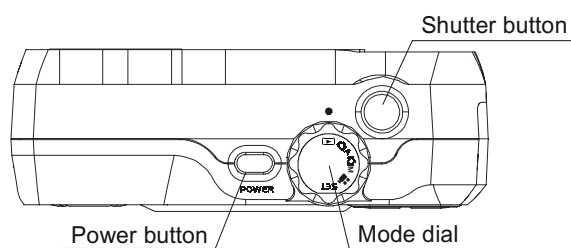

Accessory Set-up

Attaching the Wrist Strap

- Follow the illustrations to add the wrist strap.



NOTE:

When carrying the camera by the strap, please don't swing the camera on the strap.

Using the Soft Case

- Keep the camera in its soft case while it is not in use.
- Be sure to insert the camera into the case, with the monitor screen facing down.



Preparing to Take Pictures

Battery Installation

There are two ways to supply power to the camera. You can use batteries (AA Alkaline or CR-V3), or alternatively, you can use an AC adaptor (**DC3.3V/2.0A**).

If using Batteries,

1. Open the battery cover by sliding the door in the direction indicated by the arrow on the battery cover.

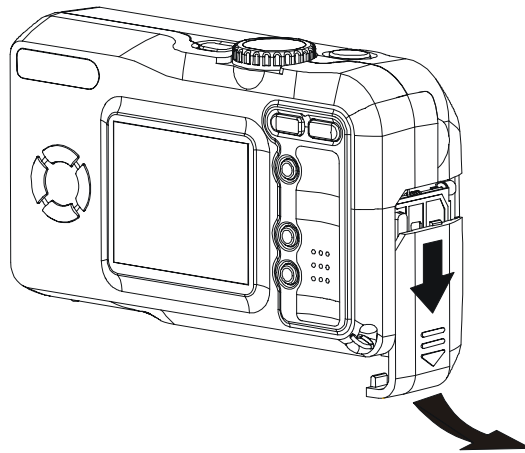

2. Check the inscription on the battery chamber for the correct negative/positive installation.
3. Install 2-AA alkaline batteries.

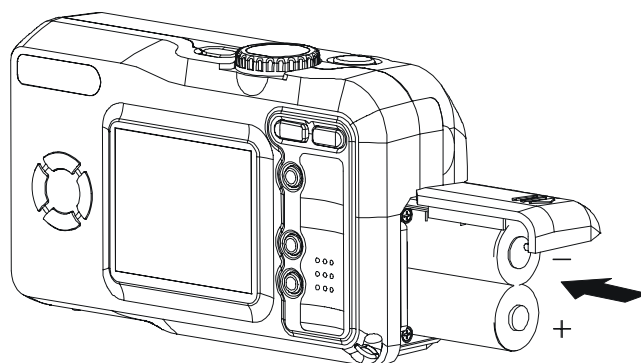

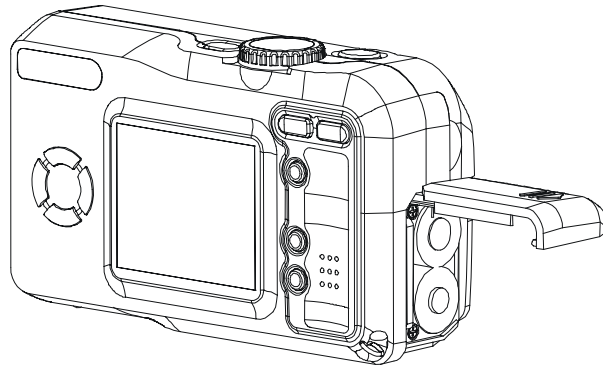

4. Close battery cover.

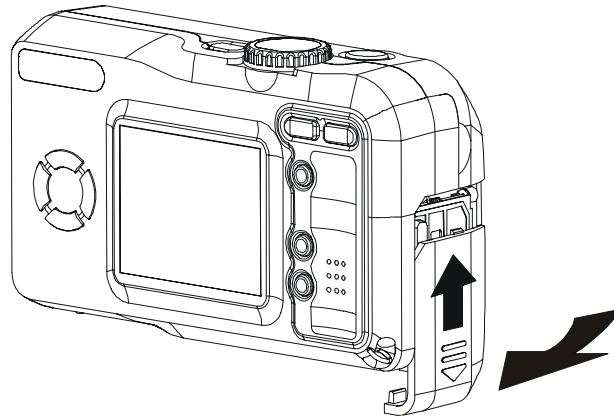

Low Battery Indicator

1. As the battery runs out of power, the “battery low” indicator shows on the monitor screen.

 - Power is running out; change the battery.

NOTE:

- Never use manganese batteries, as they cannot supply sufficient power to support the camera's operations.
- Replace all batteries at the same time to ensure a properly working camera; never mix old and new batteries.
- Remove batteries from the camera if you do not plan on using the camera for more than two weeks.

Preparing to Take Pictures

- It is normal that the temperature of the camera body rises after extended use.
- We suggest using an AC adaptor.

If using the AC Adaptor

1. Plug the adaptor into the DC-In jack (**DC-IN 3.3V**).
Please make sure that you use an AC adaptor with the correct specification for the camera (**DC3.3V/2.0A**).

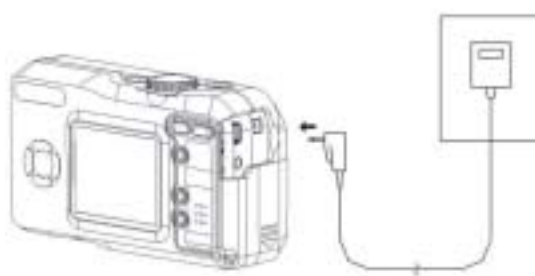

NOTE:

- Please be sure to turn off the power before connecting or disconnecting the Adaptor.
- The camera automatically switches over to AC adaptor powered operation whenever the AC adaptor is plugged into the camera.
- It is recommend to use the AC adaptor to power the camera whenever connected to a computer.



Turning the Power On

1. Press the POWER button (**POWER**) until the green indicator begins flashing.
2. It takes about 3 seconds to power on the camera.

NOTE:

- When you turn on the camera for the first time, you will be required to set up the date and time in the camera.
- If you turn on the power when the rotary dial is in SET or PLAYBACK mode, the lens will not extend to the shooting position.





Date and Time Set-Up

1. Turn the mode dial to SET mode (**SET**).
2. Press the DOWN button () until the Date & Time icon () is highlighted.



3. Then press SET button (**SET**) to DATE&TIME menu.



4. Press the UP/DOWN ( / ) to adjust the value of your setting.
5. Press the LEFT/RIGHT button ( / ) to advance to the next.

Use UP/DOWN button to change the date display.



- A. Y/M/D
- B. M/D/Y
- C. D/M/Y



6. Press the SET button (**SET**) when the OK() is highlighted to confirm your setting.

Beep Sound Set-Up

You may turn on/off the beep sound in the SET mode (**SET**).

1. Turn the mode dial to SET (**SET**).
2. Press the DOWN button () until the BEEP icon () is highlighted.



3. Then press the LEFT/RIGHT button () to select ON/OFF. Press the SET button to confirm your selection.



Note: The default setting is "On".

Quick View Setting (LCD Confirm)

You can view the picture immediately on the LCD screen right after it is taken by setting the LCD Confirm function () in SET mode (**SET**).

1. Set the mode dial to SET (**SET**).



2. Press the DOWN button () until the LCD CONFIRM is highlighted.



3. Use the RIGHT/LEFT button to select either YES/NO. Press the SET button to confirm your selection.

Auto Power Off Settings

You may select the auto power off settings while in the SET mode (**SET**).

1. Turn the mode dial to SET (**SET**).
2. Press the DOWN button () until the AUTO POWER OFF icon () is highlighted.



3. Then press the LEFT/RIGHT button () to select OFF / 1 MIN. / 3MIN. or 5MIN. Press the SET button to confirm your selection.



Note: The default setting is “1 minute”.

1 minute: This camera will automatically turn off if there is no activity after one minute. Press the Power button to turn on the camera again.

3 minutes: This camera will automatically turn off if there is no activity after three minutes. Press the Power button to turn on the camera again.

5 minutes: This camera will automatically turn off if there is no activity after five minutes. Press the Power button to turn on the camera again.

Off: This camera will not perform the power saving function. This setting is not recommended as batteries are consumed more quickly in this setting.



TV Out Signal Set-Up

This camera can connect directly to a TV set. Please refer to Page 48 of “Viewing images on a TV set.” It allows you to use the TV screen as your camera LCD screen when shooting or replaying images.

The Video output signal can be switched between NTSC or PAL to accommodate different signal systems. The default setting will vary between regions.

NTSC: U.S.A., Canada, Taiwan, Japan, etc.

PAL: Europe, Asia (excluding Taiwan), etc.

1. Turn the mode dial to SET (**SET**).
2. Press the DOWN button () until the VIDEO SYSTEM icon () is highlighted.





3. Then press the LEFT/RIGHT button () to select NTSC/PAL.
Press the SET button to confirm your selection.



Language Set-Up

Use this feature to select the language for the LCD screen.

You may choose the language while in the SET mode (**SET**).

1. Turn the mode dial to SET (**SET**).
2. Press the DOWN button () until the LANGUAGE icon () is highlighted.





3. Then press the LEFT/RIGHT button () to select the language you need.



Returning to Default Settings

You can easily change the settings back to the default settings.

1. Turn the mode dial to SET (**SET**).
2. Press the DOWN button () until the DEFAULT SETTING () is highlighted.



3. Press the RIGHT button () to enter the setting.
4. To return to the default setting, use RIGHT button to select "YES".
5. Press the SET button to confirm the setting.



Using a Memory Card

Inserting a SD memory card

1. Slide the battery cover following the arrow direction on the battery door cover (please refer to page 6).
2. You will see the card slot next to the battery house.
3. Insert the SD card into the slot in the direction shown in the illustration.

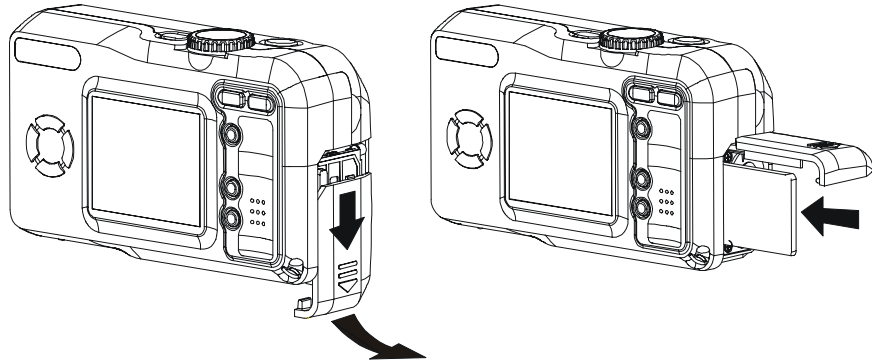

Note: SD cards are sold separately and can be purchased at most computer or electronic stores.

Removing a SD memory card

1. Press the memory card into the camera and then quickly release it. The card will partially exit from the slot.
2. Pull the memory card out of the slot.
3. Close the battery/card cover (please refer to page 7).

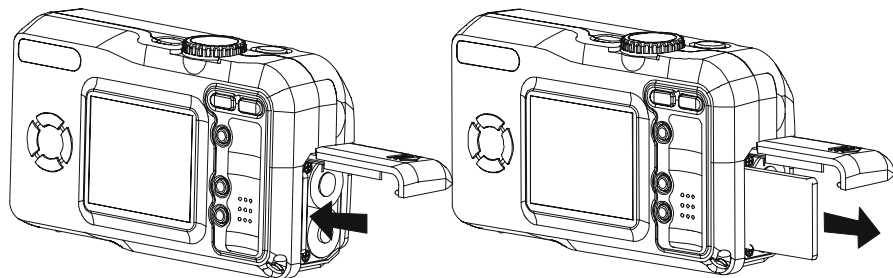

Camera Working Mode

You can select the camera's working mode by using the Mode dial located on the top of the camera. There are 5 working modes in this camera:

Auto Photo Mode ()

In this mode, the camera will automatically set the exposure and white balance according to your shooting environment.

Manual Photo Mode ()

You can manually set the exposure and white balance before shooting.

Playback Mode ()

Replay or delete images from the camera.
Download and display images on your computer.

Video Mode ()

Use this mode to record movies.
You can also manually set the white balance before recording the video.

Set Mode (**SET**)

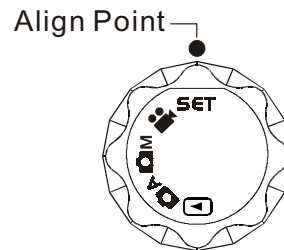

By setting each item on the Set-up menu to your preference, you can customize your camera.



Taking Pictures

Previewing a Picture before it is taken



You can preview the image on the LCD screen before you take it.

1. Set the Mode dial to Auto () or Manual ().
2. Press POWER button () to power on the camera. While the camera is powering ON, the LED indicator next to the Viewfinder will flash in Green.
3. The live image will automatically show on the LCD screen.

Turn off the previewing LCD screen

The LCD screen will be activated in all modes.

You can turn on/off the LCD screen by pressing the DISP button (). Turning off the LCD will also help to save battery power.

1. Press the DISP button () one time to turn off the information display.
2. Press the DISP button () twice to turn off the LCD screen.



(Auto Mode)



(Turn off the information)



(Turn off the LCD screen)

Using the Auto Focus Indicator



When recording with the LCD screen, align the Auto Focus Indicator on the LCD screen with the center of the subject.



AF Indicator

Turn off the Auto Focus Indicator

You may turn off the Auto Focus Indicator in SET Mode (**SET**)

1. Turn the mode dial to SET (**SET**).
2. Press the DOWN button () until the FOCUS INDICATOR () is highlighted.

3. Press the RIGHT button () to select OFF.



4. Press the SET button to confirm your selection.



(AF Indicator if OFF)

Using the Zoom feature

You can zoom in on a subject for a telephoto shot, or zoom out for a wide-angle shot.

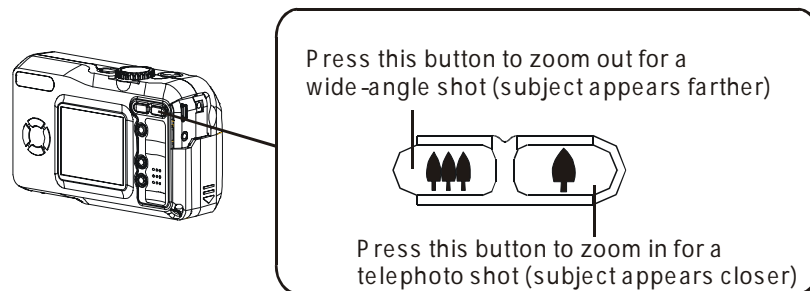

NOTE:

The lens portion moves during the zoom operation. Be careful not to touch the lens portion while it is moving.

Digital Zoom Function

This camera has a digital zoom function.

Digital zoom enlarges the image through digital processing and it starts to function when the zoom exceeds 3x. Images can be zoomed up to 6 times which combines the effect of the the optical zoom.

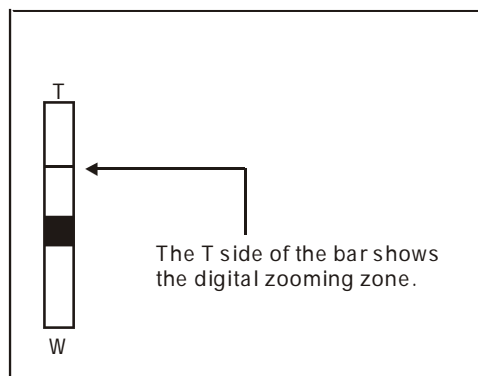

Taking a picture

There are two picture taking modes. In Auto Mode, all you have to do is press the shutter button and let the camera judge the environmental conditions for you. In Manual Mode, you can manually adjust the exposure and set the white balance based on different environmental conditions.

If you don't insert the SD card into the camera, you can take pictures and store them in the camera's memory. Once you insert the SD card in the camera, all new images captured will be saved on the card.

Taking a Picture in Auto Mode

1. Select the Mode dial to Auto ().
2. Press the POWER button (**POWER**) to turn on the camera.
3. Press the Shutter button halfway and align the auto focus mark on the subject you want to take. When the focus is locked, the auto focus mark turns Green and the LED indicator next to the viewfinder lights in green.
4. Take a picture by pressing the shutter button further. When it makes a sound, the image has been taken and will be recorded on the card or on board memory.

* The Auto Focus Indicator will not appear if the Focus Indicator setting is turned off.

* The beep will not sound if the beeper setting is turned off.

5. While recording the image on the memory card, the LED indicator will flash in Green. Once the LED indicator stops flashing, the recording has finished.

Note: The camera will emit a stream of beeps when the memory is full.

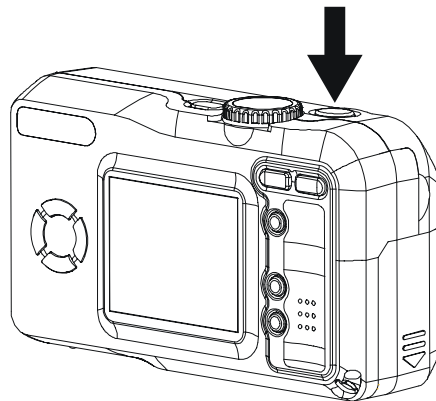
**NOTE:**

- While pressing the shutter button halfway down, a “Hand Shaking” icon () appears under the auto focus indicator, it may suggest that the focus on the subject is difficult, and/or the camera is not held securely.
- While pressing the shutter button halfway down, you can also check if there is proper exposure value.
- If the display indicator on the LCD screen turns green, it means the camera has automatically selected the exposure and white balance for you.
- If the display indicator on the LCD screen turns red, this means the camera’s auto exposure and auto white balance function is not ready or the environmental conditions are not conducive to taking optional quality pictures.
- Adjust the lighting conditions by either decreasing or increasing the surrounding light. If you do not adjust the lighting conditions, your pictures may be over or under exposed.

Setting the Image Quality and Size in Auto Mode

1. Select the Mode dial to Auto ().

2. Press the MENU button (**MENU**).



3. Press the UP/DOWN button to set the image quality and size.
4. Press the SET button to confirm the setting.

| Display Icon | Quality | Resolution |
|--------------|---------|-------------|
| | Fine | 2048 x 1536 |
| | Normal | 2048 x 1536 |
| | Fine | 1600 x 1200 |
| | Normal | 1600 x 1200 |
| | Normal | 1024 x 768 |
| | Normal | 640 x 480 |

Taking a Picture in Manual Mode

1. Turn the Mode dial to Manual ().
2. Press the POWER button (**POWER**) to power on the camera.
3. The shooting procedures are the same as “Taking a picture in Auto Mode”.

Changing the Picture Resolution

You can adjust the resolution of images you will record while in the Manual Mode.

Change the Picture Resolution:





1. Turn the Mode dial to Manual().

2. Press the MENU button.
3. Use the UP/DOWN button to set the resolution of image ().





4. Press Menu again to confirm the setting or press the RIGHT/LEFT button to choose another setting. Press the MENU button to confirm your selection.

After setting the resolution and quality, the following information icons will appear on the bottom right hand corner of the LCD screen.

| Display Icon | Resolution |
|---|-------------|
|  | 2048 x 1536 |
|  | 1600 x 1200 |
|  | 1024 x 768 |
|  | 640 x 480 |

Change the Picture Quality (Compression):



1. Turn the Mode dial to Manual().
2. Press the MENU button.
3. Press the RIGHT button and select COMPRESSION ().



Taking Pictures



4. Use the UP/DOWN button to set the quality of image compression.
5. Press Menu to confirm your selection or press the RIGHT/LEFT buttons to choose an alternative setting.

After setting the resolution and quality, the following information icons will appear on the bottom right hand corner of the LCD screen.

| Display Icon | Quality  |
|---|---|
|  | Super Fine & Fine |
|  | Normal |

Adjusting the Exposure

You can manually set the exposure value (EV value ) to compensate for lighting conditions. This setting is used to obtain better results when shooting backlighting, indirect indoor lighting or a dark background.

1. Set the Mode dial to Manual ()
2. Press the MENU button.
3. Use the RIGHT button to toggle to the Exposure icon (+/-) ()



4. Use the UP/DOWN button () to set the exposure value.
5. Press Menu again to confirm the setting or press the RIGHT/LEFT buttons to adjust other settings.



EV Value: -2.0, -1.7,-1.3,-1.0,-0.7,-0.3,0.0, +0.3,+0.7,
 +1.0,+1.3,+1.7,+2.0



After you manually set the exposure value in "Manual" capture mode, the exposure value will be shown on the LCD screen.

Setting the White Balance

You can set the white balance mode to match different types of light sources.





1. Set the Mode dial to Manual ().
2. Press MENU and select WHITE BALANCE ().



3. Use the UP/DOWN button to set the white balance mode.
4. Press the MENU button to confirm the setting or press the RIGHT/LEFT buttons to choose the next setting.





After you manually set the white balance mode in "Manual" capture mode, the following information will be shown on the LCD screen.

- **AUTO** - Normal conditions
(camera adjusts white balance automatically)
-  - Outdoor daylight
-  - Cloudy
-  - TUNGSTEN (Indoors, illuminated by tungsten lighting)
-  - FLUORESCENT (Indoors, illuminated by fluorescent lighting)
-  - converts images to black and white

Changing the ISO Speed

You can change the camera's sensitivity to light by selecting the ISO value.

1. Set the Mode dial to Manual (M).
2. Press MENU and toggle to ISO SETTING (.
3. Use the UP/DOWN button to set the ISO value you need.



- Auto: The camera's sensitivity is automatically changed by different lighting values or subject brightness.
- 100/200/400: In the same lighting condition, the higher the ISO value is, the faster the shutter speed will be.



4. Press the MENU button to confirm the setting or press the RIGHT/LEFT buttons to choose the next setting.



After you manually set the ISO Speed in the "Manual" capture mode, the ISO value will be shown on the LCD screen.

Setting the Slow Shutter Mode

The normal shutter speed ranges between 1/2000th of a second, but by setting the slow shutter mode, you can slow the shutter speed to 1 sec./2 sec./4 sec/8 sec. mode.

1. Set the Mode dial to Manual ().
2. Press MENU and select SLOW SHUTTER ().



3. Use the UP/DOWN button to set the slow shutter speed.
4. Press the MENU button to confirm the setting or the RIGHT/LEFT button for the next setting.







After you manually set the Slow Shutter Speed in the "Manual" capture mode, the shutter speed will be shown on the LCD screen when the shutter button is pressed halfway and the subject is focused.

NOTE:

It is recommended to use a tripod to keep the camera steady when you are using the slow shutter speed mode.

Setting the Flash

Press the  button to select the flash mode.

| Mode | Auto | Manual | Video |
|---|------|--------|-------|
| Auto Mode  | ○ | ○ | X |
| Red-Eye Reduction  | ○ | ○ | X |
| Flash Off  | ○ | ○ | X |
| Flash On  | ○ | ○ | X |

○ : Available

X : Not Available

Using the Macro mode

Press the MACRO button () to record subjects at a distance of 10 ~ 50cm when at the maximum wide angle setting and at a distance of 16cm when at the maximum telephoto setting.

| Mode | Auto | Manual | Video |
|-------|------|--------|-------|
| Macro | ○ | ○ | ○ |

○ : Available



X : Not Available

NOTE:

- The distances mentioned above represent the distances from the camera's lens surface to the subject.
- The flash is set to "Flash Off"  each time the Macro feature is activated.
- Users can change the flash setting to "Flash Fill" by pressing the Flash button. The Auto Flash and Red-Eye Reduction setting cannot be set in Macro Mode.

Setting the Self-Timer

You can adjust the self-timer delay to either 2 seconds or 10 seconds.

1. Set the Mode dial to Auto () or Manual ().
2. Continually press the Self-Timer button () until the desired time setting appears in the LCD.

Self-Timer Options:

OFF - Turns the Self-Timer off.





2 SEC.(Press Self-Timer one time)

indicates a countdown of two seconds.



- 10 SEC. (Press Self-Timer twice)

Indicates a countdown of ten seconds.

3. Be sure that the  (2 sec.) or  (10 sec.) icon appears on the LCD monitor, then press the Shutter button.

Taking Pictures

- The Self-Timer LED will flash in red after the shutter button is pressed.



To cancel the Self-Timer function

Press the Self-Timer () again.

Recording Video images

This camera performs video-recording function.

- Set the Mode dial to Video ().



- Press the shutter button to start recording video clips.

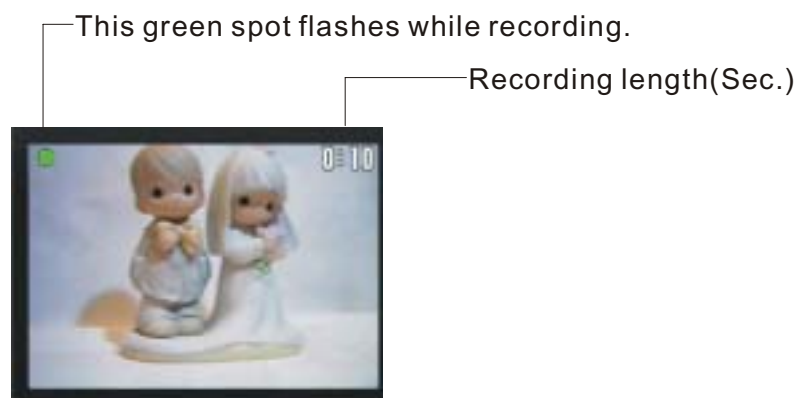

3. Press the shutter button again to stop recording.

























Adjusting the white balance before recording

Please refer to page 25.

NOTE:

- In Video mode, the resolution is set to 320x240 pixels.
- Be careful not to touch the microphone while recording.
- The maximum length of individual video recording will depend on the memory space. The recording will end automatically when the storage memory becomes full.

Functions Available in Each Shooting Mode

| Function | Mode | Auto  | Manual  | Video  |
|---|---|--|--|---|
| EXPOSURE  | Exposure Compensation Valve: -2.0 ~ +2.0 | X | ○ | X |
| WHITE BALANCE  | AUTO | X | ○ | ○ |
| | DAYLIGHT  | X | ○ | ○ |
| | CLOUDY  | X | ○ | ○ |
| | TUNGSTEN  | X | ○ | ○ |
| | FLUORESCENT  | X | ○ | ○ |
| | BLACK&WHITE  | X | ○ | ○ |
| ISO  | 100/200/400/AUTO | X | ○ | X |
| SLOW SHUTTER | 1sec./2sec./4sec./8sec. | X | ○ | X |
| RESOLUTION  | 2048 X 1536  | ○ | ○ | X |
| | 1600 X 1200  | ○ | ○ | X |
| | 1024 X 768  | ○ | ○ | X |
| | 640 X 480  | ○ | ○ | X |
| COMPRESSION  | FINE  | ○ | ○ | X |
| | NORMAL  | ○ | ○ | X |
| Flash  | Auto  | ○ | ○ | X |
| | Red-Eye Reduction  | ○ | ○ | X |
| | Off  | ○ | ○ | X |
| | Fill  | ○ | ○ | X |
| Macro Focus | | ○ | ○ | ○ |
| Self-Timer | | ○ | ○ | X |
| Zoom | | ○ | ○ | OPTICAL ZOOM ONLY |

○ : Available

X : Not Available

Reviewing Your Pictures and Videos

Viewing Pictures

You can view pictures and images in Playback mode ().

1. Turn the Mode dial to Playback (). The LCD screen displays the last image captured.



2. Use the RIGHT/LEFT button ( / ) to view different pictures.
3. Press the SET button to review video clips. Video clips are noted by an AVI extension.

NOTE:

- The image information will not be shown on the LCD screen if you press DISP button.
- When viewing video clips, use the SET button (**SET**) to play the video. Pressing the SET button again will pause the video.
- Press the RIGHT/LEFT button to stop playing the video and move to the next image.
- When the video has finished, it will display the first frame.

Replaying the Last Image Quickly

In each capture mode ( /  / ), you can quickly replay the last image you just took.

1. Press the DOWN button () to replay the last image.

Reviewing Your Pictures and Videos

If you want to delete this image, press the SET (**SET**) button.



Press the RIGHT/LEFT button to select YES/NO and then press the SET button to confirm.

2. To return to the capture mode, press the DOWN button again.

Viewing Pictures in Thumbnail

You can view up to 9 images at a time by using the THUMBNAIL function ().

1. Turn the Mode dial to Playback mode().
2. The LCD screen displays the last image captured.
3. Press the ZOOM OUT button () to display your images on the LCD screen in thumbnail view.
4. The thumbnail display will highlight the image that had been showing at the time the thumbnail mode was selected.





4. In the thumbnail display mode, you can use the four-way arrow director to select the image you want to review.
5. When the selected image is highlighted, press the ZOOM IN button

() or SET button to display the image in full screen size.

Zooming the Displayed Image

When viewing a single image in Playback Mode, you can magnify the image you selected. The scale of magnification is x1.0 ~ x8.0.

1. Turn the Mode dial to Playback mode().
2. Magnify the image up to the desired scale of magnification by using the ZOOM IN button ().
3. Press the ZOOM OUT button () to zoom back to the original full sized image.

If an image is magnified, the scale ratio indicator will be displayed on the left hand side of the LCD screen.



View different areas of the magnified image.

1. Use the four-way arrow directors to concentrate on different areas of the image.
2. The portion of image you slide to will display on the scale drawing.



NOTE:

To return to normal size, press the MENU button twice or press the ZOOM OUT button () until the image returns to its normal size.

Erasing Pictures

You can erase one or all images while in the Playback mode().

Erasing a Single Image

1. Turn the Mode dial to Playback mode (▶).
2. Press the MENU button.



3. Press the SET button to enter the "ERASE ONE" menu (🏠).





Use the LEFT/RIGHT buttons to toggle between the YES/NO options.
Press the Set button (**SET**) to confirm your selection.



4. Press the MENU button to return to the main menu.

Erasing All Unprotected Images

1. Turn the Mode dial to Playback mode().
2. Press the MENU button to enter the erase one menu and then press the right button () to enter the ERASE ALL menu ().



3. Press the SET button and then use the RIGHT/LEFT buttons to toggle between the NO/YES options.



4. Press the SET button to confirm your selection.



If you choose to erase all images, "NO IMAGE" will appear on the LCD screen.

NOTE:

Erased images cannot be recovered.

Reviewing Your Pictures and Videos



Protect or unprotect a single image.

1. Turn the Mode dial to Playback mode ().
2. Toggle through the images until you find the picture you would like to protect.
3. Press the MENU button. Press the RIGHT button () to enter the PROTECT () function.



4. Press the SET button to enter the PROTECT menu.



5. Press the Set button (**SET**) to protect () the picture or press the "MENU" button to cancel () this protection and return to the main menu.

NOTE:



1. Be sure that the PROTECT icon () appears.
2. Use the LEFT/RIGHT button to move to the next image.

To remove the protection

Press the SET button while in the Protect menu. You will see that the key () icon disappears from the bottom of the LCD

Running a Slide Show

View your pictures on the camera LCD screen by using the Slide Show feature. The pictures appear for a period of 3 seconds.

1. Turn the Mode dial to Playback mode ().
2. The last picture taken appears on the LCD screen.
3. Press the MENU button and use the RIGHT button to toggle to "Slide Show" ().



4. The slide show will automatically run from the first picture taken after you press the SET button.



NOTE:



1. You may pause the Slide show by pressing the SET button. To resume playing the slide show, press the SET button again. Wait a few seconds for the slide show to begin.

Reviewing Your Pictures and Videos

2. To stop the slide show and return to the main, press the MENU button.
3. The slide show will continue to play as long as there is power supply.
4. It is recommended to use the AC power for extended use.

Copying Flash Memory Images to a Memory Card

Copy single or all images currently in the camera's built-in flash memory to a memory card.

1. Turn the Mode dial to Playback mode ().
2. Press the MENU button and use the RIGHT button to toggle to "COPY TO CARD" ().



3. Press the SET button to enter COPY TO CARD menu.



4. Use the RIGHT/LEFT button to select "ONE" or "ALL" units to copy.

"ONE" - A single image stored in the camera's built-in flash memory will be copied to a memory card.

Use the RIGHT/LEFT button to select the image you want to copy to the card.



“ALL” - All images stored in the camera’s built-in flash memory will be copied to a memory card.

During the copying process, the images will be displayed in thumbnail mode and copied one by one.

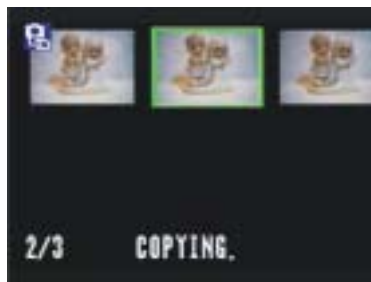

- This starts the copy operation.

NOTE: You cannot copy the images from the memory card to the camera's built-in memory.

Formatting Memory Card or On board memory

1. Select Mode dial to SET mode (**SET**).



2. When "FORMAT" is highlighted, press the RIGHT button to enter "FORMAT" () menu.



3. Use the RIGHT/LEFT button to select "YES" or "NO".
4. Press the SET button to confirm your selection.

YES - Formats the memory card.



- This starts the FORMATTING operation.
- After the memory storage is formatted, the message "NO IMAGE" appears on the camera LCD screen in Playback () mode.

NO - Cancels the formatting operation.

NOTE:

The data deleted by a format operation cannot be recovered. Make sure that you do not need any data currently stored on a memory card before you format it.

Setting Your Camera for Printing

Folders and Files

Your camera automatically creates a directory of folders in its on board memory or on the memory card to store images.

Folders Example:

100V3310
 Serial Number

1. The folder number starts from 100.
2. Each folder can hold up to 100 pictures. If a picture is taken when the current folder contains a picture file numbered 0999, your camera will create a new folder by adding one to the current folder number (for example, if the current folder is "100V3310", the new folder will be named "101V3310").
3. The maximum number of folders is 0999.

Files

Your camera automatically assigns each picture a file name consisting of "PIC_" followed by a four-digit number as described below.



File Example: .

PIC_0001.JPG
 Extension File Name
 Serial Number
 Under Line

1. Each folder can hold up to 100 pictures. If a picture is taken when the current folder contains a picture file numbered 0100, your camera will create a new folder and store the new image in the new folder.
2. In a new folder, the picture file numbering starts over from 0001.

File Number Reset

You can reset the file number function in the camera while in the “SET” mode.

1. Turn the mode dial to SET (**SET**).
2. Press the DOWN button () until File NO. RESET () is highlighted.



3. Press the RIGHT/LEFT button () to toggle between YES/NO.
4. Press the SET button to confirm the setting.

YES - When this option is selected, the camera assigns all subsequent file numbers sequentially in ascending order, starting from the last number used. If the memory card is formatted or a new card is inserted in the camera, the image file number will continue from the last number used.

NO - The camera does not store the last file number used. When another memory card is inserted or a new folder is created, the image file number starts from the lowest number available.

DPOF Print Settings

On your SD card, select the image or images you want to print and how many copies you want. This is convenient for printing on printers with the DPOF function or at any print service.

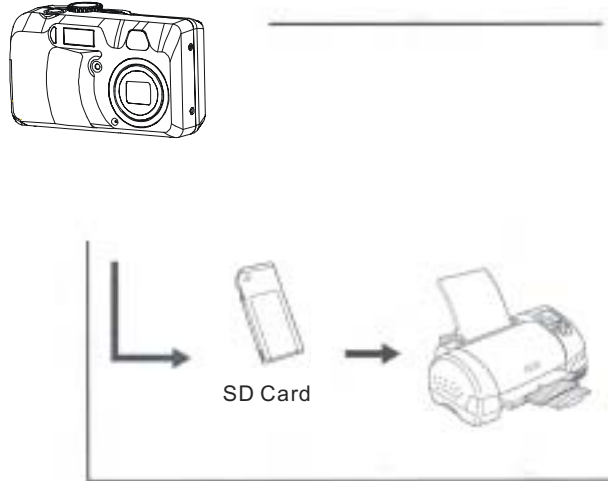

DPOF



The letters “DPOF” stand for “Digital Print Order Format”, which is a format for recording on a memory card or other medium. You can print on a DPOF-compatible printer or at a professional print service from the memory card.

Print Order Setting

1. Turn the Mode dial to PLAY mode (▶).
2. Use the RIGHT/LEFT button to select the image you want to print.
3. Press the Menu button.

Setting Your Camera for Printing

4. Press the RIGHT button to toggle to PRINT SETTING.



5. Press the SET button to enter the SETTING MODE.



SETTING Modes:

Press the SET button (**SET**) to confirm that you would like to print this picture. ()

Once this picture is confirmed for printing, the tick sign appears in the box.



Setting for the next image

- After setting the first image, use the RIGHT/LEFT button to scroll to the next image you want to print.
- Follow the above PRINT SETTING procedures.

Returning to Main Menu of Playback Mode

- In SET (**SET**) setting mode, press MENU button (**MENU**) to return (**↩**) to the main menu of Playback mode.

RESET Mode

The Reset feature clears all printing settings.

PRINT Image Matching



This camera supports PRINT Image Matching. Images recorded with this feature include information about the mode setting, camera setup, etc. When you print an image on a printer that supports PRINT Image Matching, the printer reads this data and adjusts the printed image accordingly. See the documentation that came with your printer for full details about PRINT Image Matching.

NOTE:

- PRINT Image Matching is a term for the print command that is embedded in header file for the image created by the Digital Camera. It contains color setting and image parameter information.
- SEIKO EPSON Corporation holds the copyright for PRINT Image Matching.

Installing the Driver & Software

Note: You do not need to install the drivers if you are running Windows ME, 2000 or XP.

Please go to the "Installing the Software" section.

Note to Mac users: You do not need to install drivers or software to transfer pictures.

Please see "Downloading Images to a Computer" for instructions.

Installing the Driver

Installing Camera Drivers (Windows 98/98SE)

If your operating system is Windows 98/98SE:

1. Insert the CD into your PC CD-ROM drive. Make sure that your camera is not connected to the computer.
2. A check mark appears on the left side of each installation choice. Remove all checks except the one for the camera driver by clicking on the checks next to each choice.



3. Click on install.
4. Follow the on-screen instructions. After the installation has finished, reboot your computer. You are now ready to install the software.

NOTE:

If your system requires a manual installation: Click Run, type "(the CD-ROM drive):/install.exe", then click OK.

Follow the directions that follow to install all the software.

Installing the Software

Installing the Software (Windows Users)

You may choose to skip the software installation procedure if you already have photo editing software loaded on your computer or if you would like to transfer pictures without editing them.

Please refer to the Downloading Images section for instructions on transferring pictures to your computer.

If your operating system is Windows 98/98SE/2000/ME/XP:

1. Insert CD into your PC CD-ROM drive. Make sure that your camera is not connected to the computer.
2. Click on Photo Studio, Movie Studio, Video Conferencing and Panorama tools. A red check mark should appear in the circle next to each option. Camera Driver does not need to be checked.
3. Click on install.



1. Click the MGI PhotoSuite 4 SE menu on autorun frame.



2. A Welcome window will be displayed. Click [Next>] to move to the next step.

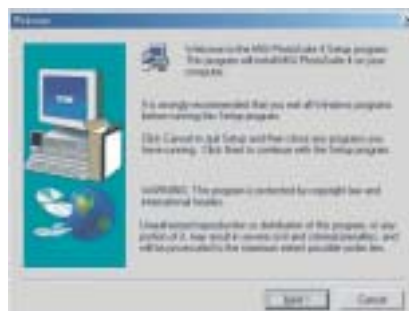

3. The Software License Agreement window will be displayed.
If you agree to this, click [YES], the window will then move to the next step. If you disagree, click [NO] and the install program will be canceled.

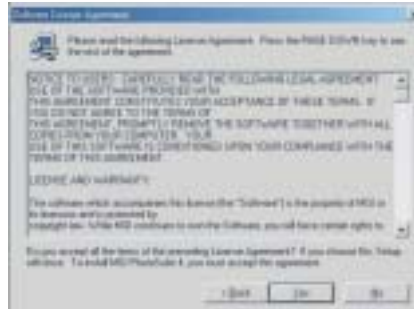

4. Click Next to continue the installation.



5. Select Destination Location. Click on Next



Installing the Software

6. We suggest creating a shortcut on your desktop by selecting this option. Click Next to continue the installation.



7. Click Next to continue the installation.



8. Start Copying Files window will displayed. Click [Next>] to start installation.

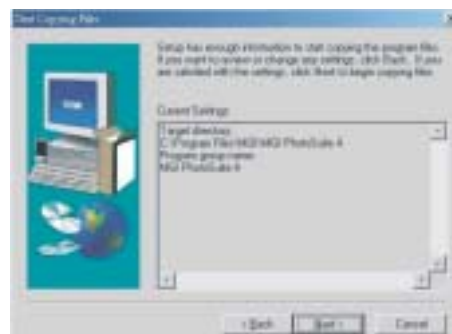

9. Wait while the software is installed.



10. Click Finish to complete the the setup.



11. Click Continue.



12. Click Cancel if you would like to complete the registration at a later date. If you would like to register now, complete the registration form and click Register.



13. Select "Yes, I will restart my computer".



MGI Video Wave will install next. Follow the on screen instructions. After the installation has finished, choose YES when asked to restart.

Photo Vista will install next. Follow the on screen instructions. After the installation has finished, choose YES when asked to restart.

NOTE:

If your system requires a manual installation: Click Run, type "(the CD-ROM drive):/install.exe", then click OK.

Using MGI PhotoSuite 4 SE

1. Click Start> Programs> MGI PhotoSuite 4> MGI PhotoSuite 4 or click on the MGI icon on your desktop.
2. This will open the MGI PhotoSuite software to edit, crop and print your pictures.

Connecting your camera

Viewing Images on a TV Set

Images displayed on the camera's monitor screen can also be displayed on a television screen.

1. Use the video cable to connect the camera to the TV set as shown.

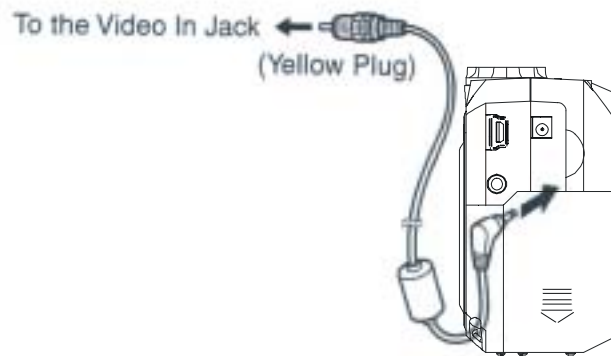

2. Adjust your television set so that you obtain video input.
3. Normal playback and recording functions are available.

NOTE:

The camera LCD screen turns off automatically during video output.

Selecting the Video Output Signal Mode

Your camera supports both NTSC (used in U.S., Japan, and other countries) and PAL (used in Europe and other areas) video output signal systems. Please refer to Page 14 for instructions on how to change your Video output signal to the correct setting.

Downloading Images to a Computer

There are two ways to download images taken with the camera to a computer.

- Connect the camera to a computer via the USB cable.
- Directly from the SD card.

After installing the supplied software, download images automatically by simply connecting the camera to a computer with the supplied USB cable.

Downloading Images Directly from a SD card

1. Eject the SD card from the camera, and inset it into a SD card reader which is connected to the computer.



If you are using a PC card reader, first insert the SD card into a PC card adapter, and then insert the PC card adapter into the computer's PC card reader.

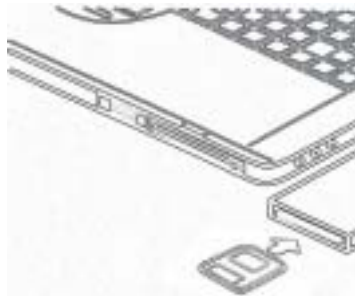

2. Double-click the icon of the drive with the SD card.
3. Copy images from the card into a folder of your choice on the hard disk.

Connecting the Camera to a Computer via USB Cable (Windows Users)

1. Make sure that you install the software and driver that comes on the CD-ROM first.
2. Connect the supplied USB cable to the computer's USB port. Please refer to your computer manual for information regarding the USB port location.

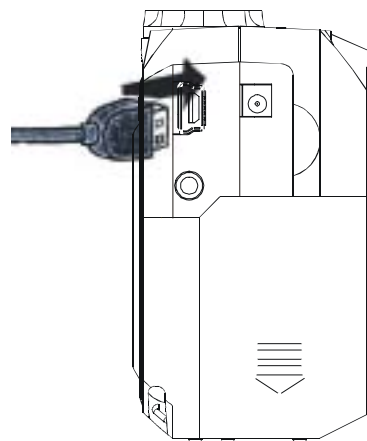
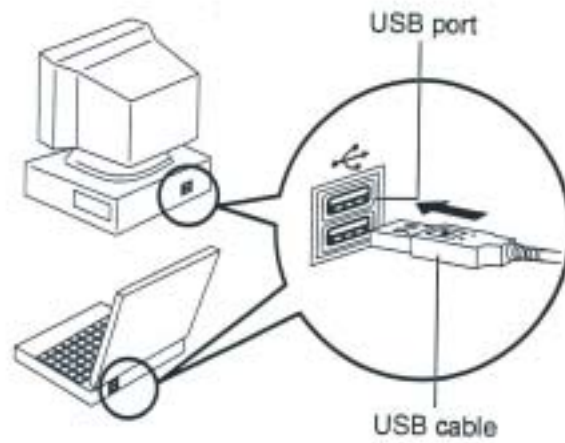

1. Open the terminal cover with your fingernail.
2. Insert the connector until it clicks.

3. Turn on your camera.
When the connection to the computer is complete, the LCD screen turns off.

NOTE:

- When you disconnect the USB cable while the camera is on, the camera will automatically turn off.
 - It's recommended to power the camera from a household power outlet with an AC Adapter.
 - If you are running Windows 98, the first time the camera is connected to the PC a message will appear on your monitor "Unknown device"; The driver installation will finish.
4. Click on "My Computer" and a "Removable Disk" drive will be displayed.
Note: Windows XP users will see "Internal" instead of "Removable Disk."
 5. Double-click the " Removable Disk" and you will see a "DCIM" folder.
 6. All the images stored in the camera are transferred to the "DCIM" folder. If an SD card is inside the camera, only the images on the card will be transferred.
 7. You can save your pictures to any location on your hard drive.
Use the MGI software to edit your photos.

Transferring Images to a Mac

1. Set the camera to review mode.
2. Connect the supplied USB cable to the camera and the computer's USB port.
Please refer to your computer manual for information regarding the USB port location.
3. Turn on the camera.
4. The INTERNAL icon will appear on your desktop and the iPhoto screen will pop up.
You may use either iPhoto or the INTERNAL icon to acquire images.
Using iPhoto: Click on Import to transfer pictures.
Using the INTERNAL icon:
 1. Click on the INTERNAL icon.
 2. The DCIM folder will appear. All the images stored in the camera are transferred to this folder. Open the folder and double click to view the images.

About the memory storage you are using in this camera

Internal Memory

This camera has internal memory. If you do not insert a SD card into the camera, all images taken will be stored in the camera's internal memory. If you insert a SD card into the camera, the images taken will be stored in the SD card.

Memory Card Data

Images recorded with this camera and other data are stored on the memory card using DCF (Design rule for Camera File system) protocol. DCF protocol is designed for image and other data exchange between digital cameras and other devices.

DCF Protocol

DCF Protocol defines the format for image file data and the directory structure for the memory card. Images taken by a DCF camera, can be viewed in other DCF cameras as well.

Reference

Indicator Lamp Reference

| Mode | No. | Camera Status | LED | ALWAYS ON | Blinking (UNIT: ms) | | Video | Playback | Auto | Manual | |
|---------|--------------------------|-----------------------------------|-------------------|------------|---------------------|-----|-------|----------|------|--------|---|
| | | | | | ON | OFF | | | | | |
| General | 1 | Power On (till ready) | Green | | 130 | 130 | ○ | ○ | ○ | ○ | |
| | 2 | Dial Mode Change | Green | | 130 | 130 | ○ | ○ | ○ | ○ | |
| | 3 | Mass Storage | Green | ○ | | | ○ | ○ | ○ | ○ | |
| | 4 | LCD is OFF | Green | ○ | | | ○ | ○ | ○ | ○ | |
| REC | 1 | Charge for Flash (till ready) | Red | | 130 | 130 | | | ○ | ○ | |
| | 2 | Video AF Lock (AE/AWB Unlock) | Green | ○ | | | ○ | | | | |
| | 3 | Video Recording | Green | | 500 | 500 | ○ | | | | |
| | 4 | Still AF/AE/AWB Lock | With Flash | Red | ○ | | | | | ○ | ○ |
| | | | Without Flash | Green | ○ | | | | | ○ | ○ |
| | 5 | Capture Still Image | With Flash | Red | ○ | | | | | ○ | ○ |
| | | | Without Flash | Green | ○ | | | | | ○ | ○ |
| | 6 | Saving Image | Charging Flash | Red | | 130 | 130 | | | ○ | ○ |
| | | | No Charging Flash | Green | | 130 | 130 | | | ○ | ○ |
| | 7 | Self-time Capture (10sec., 2sec.) | With Flash | Red | | | | | | | |
| | | | Without Flash | Self-timer | | | | | | ○ | ○ |
| | 8 | Self-time Capture 2sec. | Self-timer | | 125 | 125 | | | | ○ | ○ |
| 9 | Self-time Capture 10sec. | 1~4 sec. | Self-timer | | 500 | 500 | | | | ○ | ○ |
| | | 5~8 sec. | Self-timer | | 250 | 250 | | | | ○ | ○ |
| | | 0~10 sec. | Self-timer | | 125 | 125 | | | | ○ | ○ |
| PLAY | 1 | Erase All | Green | | 130 | 130 | | ○ | | | |
| | 2 | Slide Show (Reading Image) | Green | | 130 | 130 | | ○ | | | |
| | 3 | Copy to Card (Copying) | Green | | 130 | 130 | | ○ | | | |

Troubleshooting

| Problem | Cause | Action |
|-------------------------|---|--|
| Power does not turn on. | <ul style="list-style-type: none"> - Batteries are inserted in the wrong direction. - Batteries are dead. - The battery cover is open. | <ul style="list-style-type: none"> - Reload batteries in the correct direction. - Replace with new batteries. - Make sure the battery cover is closed securely. |

| Problem | Cause | Action |
|---|---|--|
| Images are not recorded when the shutter release button is pressed. | <ul style="list-style-type: none"> - The mode dial is set to Playback mode. - Flash is charging. - Memory is full. | <ul style="list-style-type: none"> - Turn your mode dial to Auto mode or Manual mode. - Wait until the flash is charged. - Delete images you no longer need. |
| The camera does not take pictures | <ul style="list-style-type: none"> - The model dial is set to Playback mode. - The flash is charging. - Memory is full. - The SD card is not formatted correctly. | <ul style="list-style-type: none"> - Turn the mode dial to Auto mode, Manual mode or Video mode. - Wait until the flash charges. - Insert a new SD card. - Delete images you no longer need. - Format the card correctly. - The card may be defective. |
| Images are blurry or out of focus. | <ul style="list-style-type: none"> - The camera moved - The subject was out of focus range | <ul style="list-style-type: none"> - Hold the camera steady when shooting. - Be sure that there is at least 80cm between the camera lens and the subject. - Use the macro mode to shoot close-up images at a distance of 20cm. - When shooting distant subjects, use the camera to Normal/Infinity focus mode. |
| Recorded images are not saved in memory. | The camera powers off before the save operation has completed. | If the low-battery indicator appears on the camera LCD screen, replace batteries with a full set of new ones. |
| Images are not displayed. | A memory card with non-DCF images recorded with another camera are loaded in the camera. | This camera can not display non-DCF images. |
| The flash doesn't fire. | The flash mode is set to Off. | Set the flash to any other mode except Off. |
| Images do not show on the TV. | <ul style="list-style-type: none"> - There is a problem with the camera-TV connection. - Incorrect video system setting. | <ul style="list-style-type: none"> - Please use the attached video cable to connect the camera to the TV correctly. - Set the video system to the appropriate setting, NTSC or PAL for your TV. |
| Cannot transfer images after connecting to a computer with USB cable. | <ul style="list-style-type: none"> - USB driver is not installed. - Camera is turned off. | <ul style="list-style-type: none"> - Install the USB driver before you connect the camera to a PC. - Turn the camera on. |

Default Setting in Each Camera Working Mode

| Working Mode | Descriptions | Default |
|----------------------|-----------------------------|-------------------------------|
| Playback | Image Information Disp Mode | Basic |
| Auto Photo Mode | Quality/Size | 2048x1536/Normal |
| | Flash | Force Off |
| | PreView Disp Mode | Display Image and Information |
| Manual Photo Mode | Size | 2048x1536 |
| | Quality | Normal |
| | Flash | Force Off |
| | Exposure Compesation | 0.0 |
| | White Balance | AUTO |
| | ISO Speed | AUTO |
| | PreView Disp Mode | Display Image and Information |
| Video Recording Mode | White Balance | AUTO |
| | PreView Disp Mode | Display Image and Information |
| Setup Mode | Beep | ON |
| | Date Style | YMD |
| | Focus Indicator | ON |
| | Auto Power Off | 3 Min. |
| | LCD Confirm | ON |
| | TV Out | NTSC |
| | Language | ENGLISH |
| | File No. Rest | ON |

Specification

| | |
|-------------------------|---|
| Sensor | 3.34 Mega Pixel CCD (effective pixels: approx.3.1 Mega Pixels) |
| Lens | F 2.66 ~ 10.383 |
| Built-In Viewfinder | Optical Viewfinder |
| Focus Range | Normal Mode: Infinity~50cm, Macro Mode:16cm~50cm |
| Sensitivity | Auto, 100,200,400 |
| LCD Display | 1.5" Color TFT LCD panel |
| Still Image Resolution | 2048x1536, 1600x1200, 1024x768, 640x480 |
| Video Resolution | 320x240 |
| Still Image Quality | Fine: 5X compression rate Normal: 10X compression rate |
| Exposure Control | Auto & Manual |
| Shutter Control | Mechanical Shutter With CCD variable electronic shutter More than 1/1000 |
| Digital Zoom | Preview Mode: up to 2X continuous Playback Mode: up to 4X |
| Image File Format | EXIF 2.1 compatible format (JPEG Compression) DCF compatible. Support DPOF, PIM |
| White Balance | Auto/Manual (5 modes in manual selection: day light shade/ tungsten/fluorescent/black & white) |
| Picture Storage | On-board flash memory: 16MB External: SD memory card |
| Microphone | Built-In |
| Communication Interface | USB 1.1 |
| Self-Timer | 2 steps, 2/10 sec. with Beep sound |
| Video & Audio Out | Yes, NTSC/PAL |
| Power Supply | 2xAA batteries DC Input: +3.3V DC adapter |
| Dimensions | Camera body: 107.5x63x36.4 mm |
| Weight | Camera body without battery: 170g |

*** Specifications are subject to change without prior notice.**

Technical Support Hot Line:

Toll Free In the USA & Canada

1-866-522-6372

Toll Free In Europe

UK: 0800-169-6482

BELGIUM: 0800-787-57

FRANCE: 0800-917-599

GERMANY: 0800-1800-563

SPAIN: 900-973-195

ITALY: 800-781-883

All Other Countries - Toll

31-53-482-9779

Free Manuals Download Website

<http://myh66.com>

<http://usermanuals.us>

<http://www.somanuals.com>

<http://www.4manuals.cc>

<http://www.manual-lib.com>

<http://www.404manual.com>

<http://www.luxmanual.com>

<http://aubethermostatmanual.com>

Golf course search by state

<http://golfingnear.com>

Email search by domain

<http://emailbydomain.com>

Auto manuals search

<http://auto.somanuals.com>

TV manuals search

<http://tv.somanuals.com>