



MIT-CAT5

8 and 16 Port KVM User Guide



North American HQ
Walnut, California
Tel: 1 (909) 444 9288
info@ConnectPRO.com

Asian HQ
Taipei, Taiwan
Tel: 886-2-2253-5077
asia@ConnectPRO.com

www.ConnectPRO.com

support@ConnectPRO.com

Vers. 5.03.04

Table of Contents

1. Welcome.....	3
2. Introduction.....	4
3. Features.....	4
4. System components.....	4
5. Compatibility.....	4
6. The CAT5 KVM system configuration.....	5
7. The CAT5 KVM models.....	5
8. Pre-installation guidelines.....	6
9. Connecting the CAT5 KVM system.....	6
10. Connecting the power supply.....	9
11. Updating the LEDs.....	9
12. Resetting the Switch.....	9
13. Rack mounting the CAT5 KVM.....	10
14. Rack mounting the CIMs.....	10
15. Operating the CAT5 KVM system.....	11
16. The keyboard hotkeys.....	11
17. The OSD.....	11
18. Navigating the OSD.....	12
19. Selecting a computer.....	12
20. The OSD settings (F2).....	12
21. The General settings.....	12
22. F7 Defaults.....	15
23. The Ports settings.....	15
24. The Time settings.....	16
25. Users	17
26. Security.....	18
27. The OSD HELP window – F1.....	19
28. Scanning computers– F4.....	19
29. Tuning – F5.....	20
30. Moving the label – F6.....	20
31. Using the Control software.....	20

32. Control software system requirements.....	21
33. Connecting the RS232 Serial cable.....	21
34. Installing and running the Control software.....	21
35. Computer icons.....	22
36. Communication Error.....	23
37. The View menu.....	23
38. Selecting a computer.....	23
39. The toolbar buttons.....	23
40. Get Status.....	24
41. Read Configuration.....	24
42. Write Configuration.....	24
43. Loading a saved configuration.....	26
44. The factory default settings.....	26
45. Reminder!.....	26
46. Password protection.....	27
47. Upgrading the CAT5 KVM firmware.....	28
48. System requirements for the CAT5 KVM Update software.....	28
49. Connecting the CAT5 KVM System.....	28
50. Connecting the RS232 Serial cable.....	28
51. Installing the software.....	28
52. Starting and configuring the CAT5 KVM Update.....	29
53. Verifying the version numbers.....	30
54. Obtaining new firmware.....	31
55. Updating the firmware.....	31
56. Reset	32
57. Troubleshooting tips.....	32
58. USB SUN Combo keys.....	34
59. Technical specifications.....	35

1. Welcome

Technical precautions

This equipment generates radio frequency energy and if not installed in accordance with the manufacturer's instructions, may cause radio frequency interference.

This equipment complies with Part 15, Subpart J of the FCC rules for a Class A computing device. This equipment also complies with the Class A limits for radio noise emission from digital apparatus set out in the Radio Interference Regulation of the Canadian Department of Communications. These above rules are designed to provide reasonable protection against such

interference when operating the equipment in a commercial environment. If operation of this equipment in a residential area causes radio frequency interference, the user, and not ConnectPRO Inc. Limited, will be responsible.

Changes or modifications made to this equipment not expressly approved by ConnectPRO Inc. Limited could void the user's authority to operate the equipment.

ConnectPRO Inc. Limited assumes no responsibility for any errors that appear in this document. Information in this document is subject to change without notice.

No part of this document may be reproduced or transmitted in any form or by any means, electronic or mechanical, for any purpose, without the express written permission of ConnectPRO Inc. Limited.

© 2003 ConnectPRO Inc. Limited. All rights reserved.

Trademarks

PS/2 is a registered trademark of International Business Machines Corporation. All other trademarks and registered trademarks are the property of their respective owners.

2. Introduction

Access and control multiple multi-platform computers from one Keyboard Video Mouse (KVM) console with the Multi-Platform CAT5 KVM (CAT5 KVM) system. The CAT5 KVM comes in 8 and 16 port models. Connect up to 8 computers to the 8 port model, and up to 16 to the 16 port model.

3. Features

- Hot-Swap - disconnect and reconnect computers without rebooting
- Scan-mode operation with variable time interval
- 1U Rack mountable
- Operate the system using an On Screen Display (OSD) or Control software or front panel push buttons or keyboard hotkeys
- Create multi-level cascade arrangements. For example by cascading the CAT5 KVM 16 Port model, connect up to up to 256 computers in the system
- The computers can be placed up to 10m/33ft from the CAT5 KVM
- Multi-platform — supports PS/2, SUN, and USB computers/servers

4. System components

The CAT5 KVM system consists of:

- Multi-Platform CAT5 KVM 8 or 16 port
- Computer Interface Module (CIMs) – PS/2, SUN, USB
- CAT5 cables (1.5m provided)
- RS232 Serial cable
- Rack mounts for the CAT5 KVM and the CIMs
- VGA Extender cable

5. Compatibility

The CAT5 KVM is compatible with:

- PS/2, SUN and USB computers/servers

- VGA, SVGA, or XGA monitors
- DOS, Windows (3X, 9X, 2000, NT4, ME, XP), LINUX, UNIX, HP UX, QNX, SGI, FreeBSD, BeOS, Open VMS, Novell 3.12-6

6. The CAT5 KVM system configuration

Figure 1 illustrates the basic configuration of the CAT5 KVM system.

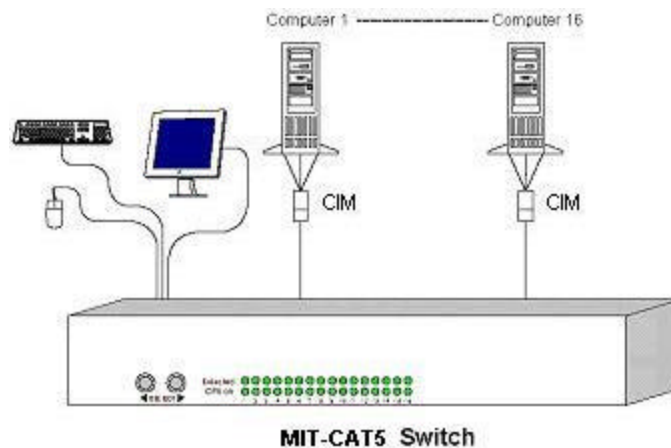

Figure 1 The CAT5 KVM system configuration

7. The CAT5 KVM models

Figure 2 illustrates the front panel of the CAT5 KVM 16 port model. The 8 port model is the same but with only 8 rows of LEDs.



Figure 2 CAT5 KVM front panel

The figure below illustrates the rear panel of the CAT5 KVM 16 port unit. The 8 port model is the same but with only 8 Computer ports.

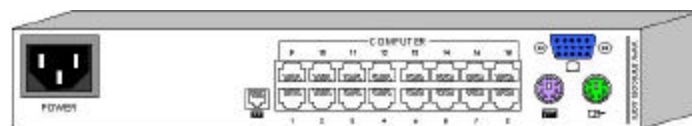

Figure 3 CAT5 KVM 16 port rear panel

8. Pre-installation guidelines

- Switch off all computers

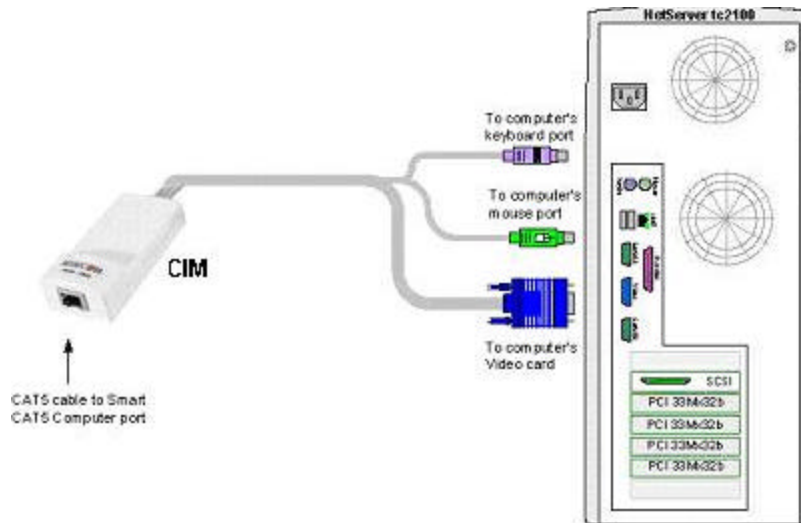

Figure 5 PS/2 CIM

Connecting a SUN CIM

Figure 6 illustrates the SUN CIM and its connections.

To connect the SUN CIM:

1. Connect the Screen connector to the computer's Video card.
2. Connect the Keyboard connector to the computer's Keyboard port.

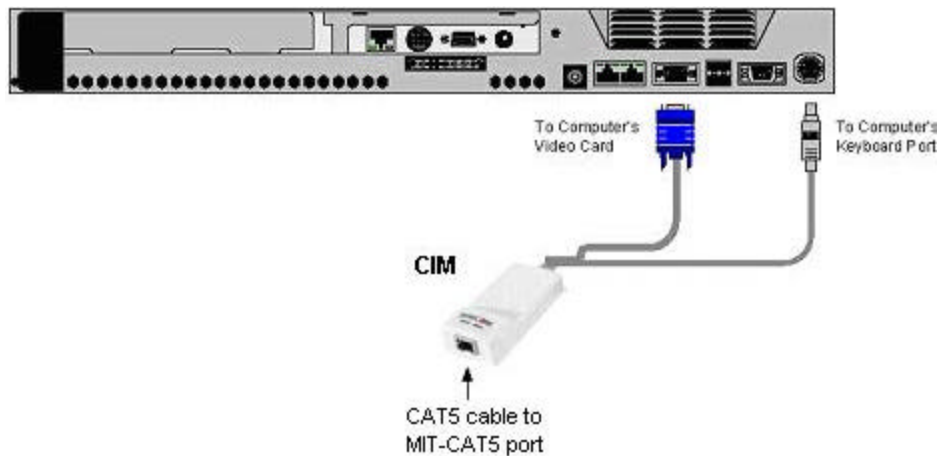

Figure 6 SUN CIM

Connecting a USB CIM

The CIM USB supports Windows 98 SE and later, MAC, SUN and SGI. Figure 7 illustrates the USB CIM and its connections.

To connect the USB CIM:

1. Connect the Screen connector to the computer's Video card.
2. Connect the USB connector to the computer's USB port.

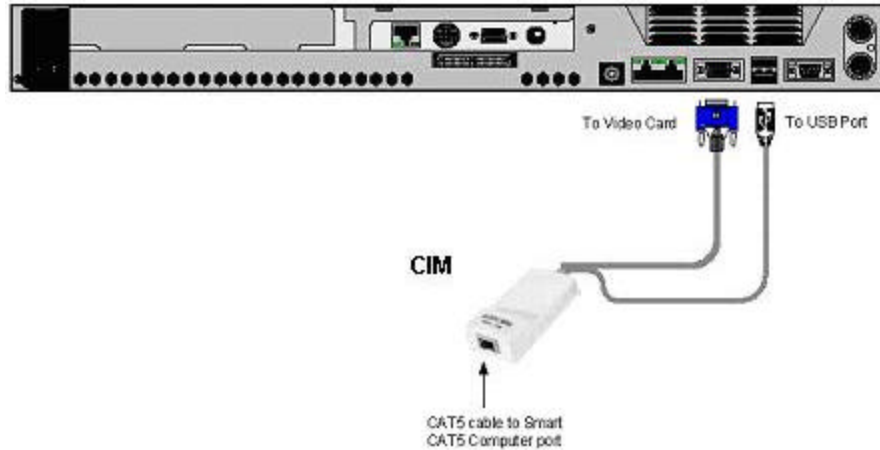

Figure 7 USB CIM

VGA Extender cable

Where the CIM's Screen connector won't reach the computer's Video card, connect the VGA Extender cable to the CIM and then follow the instructions below.

Connecting the CAT5 cables

1. Connect one connector to the CIM's RJ45 port.
2. Connect the other connector to one of the CAT5 KVM's Computer ports.
3. Follow the above 2 steps for each computer.

Connecting the KVM console

To connect a KVM console to the CAT5 KVM:

1. Connect the monitor's connector to the CAT5 KVM's Monitor port.
2. Connect the keyboard's connector to the CAT5 KVM's Keyboard port.
3. Connect the mouse's connector to the CAT5 KVM's Mouse port.

10. Connecting the power supply

1. Connect the CAT5 KVM to the power supply using the Power cable provided.
2. Switch on the computers.

11. Updating the LEDs

The front panel CPU onputers when you do one of the following:

- Open the OSD (On Screen Display) – see below
- Press the 2 front panel Select buttons simultaneously.

12. Resetting the Switch

To reset the Switch press the 2 front panel Select buttons simultaneously. The CIMs are unaffected by this reset.

Resetting can also be performed through the software – explained later.

13. Rack mounting the CAT5 KVM

Use the L-shaped brackets and screws provided to mount the CAT5 KVM on a server rack as illustrated below.

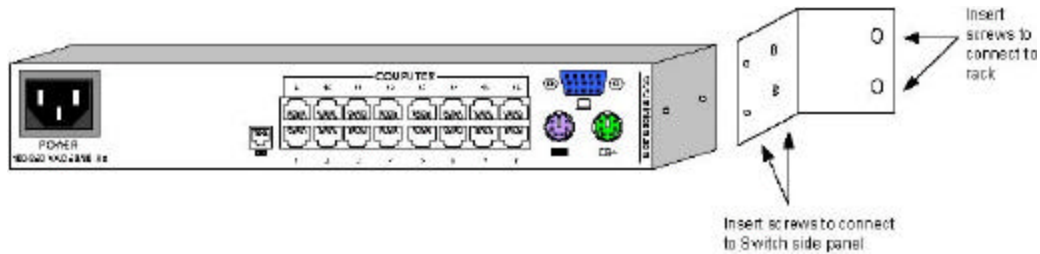

14. Rack mounting the CIMs

You can attach the CIMs to a server rack or computer using the Velcro strips provided. Or connect it using the bracket provided.

The figure below illustrates the bracket.

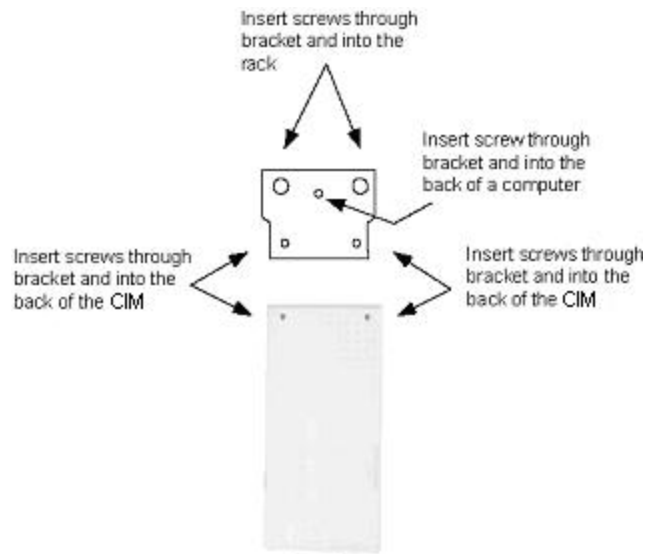

15. Operating the CAT5 KVM system

Switch between the connected computers by either

- The front panel Select buttons
- Keyboard hotkeys
- The OSD (On Screen Display)

The OSD is also the place to adjust various settings as explained below.

When switching computers the illuminated LED of the top bank indicates which computer is currently selected.

16. The keyboard hotkeys

To switch to the next computer forwards press **Shift** then, +. Release **Shift**, before pressing +.

To switch to the next computer backwards press **Shift** then, -. Release **Shift**, before pressing -.

Note! With a US English keyboard you can use the + of the alphanumeric section or of the numeric keypad. With a Non-US English keyboard only use the + of the numeric keypad.

17. The OSD

To display the OSD:

Press **Shift** twice. The OSD Main window appears. See Figure 8. Lines with blue text show active computers. Lines with grey text show inactive computers.

The Type column indicates whether a computer “C” or another switch “S” is connected to the port.

MIT CAT5 SWITCH		
MAIN		
---	NAME	TYPE
0 1	COMPUTER	D 1 C
0 2	COMPUTER	0 2 C
0 3	COMPUTER	0 3 C
0 4	SWITCH	0 4 S
0 5	COMPUTER	0 5 C
0 6	COMPUTER	0 6 C
0 7	COMPUTER	0 7 C
0 8	COMPUTER	0 8 C

Port number appears here

Instruction keys

C=computer
S=switch

F 1 - H E L P F 2 - S E T T I N G S

Figure 8 The OSD Main window

18. Navigating the OSD

To navigate up and down use the Up and Down arrow keys.

To jump from one column to the next (when relevant) use the Tab key.

To exit the OSD or return to a previous window within the OSD press **Esc**.

19. Selecting a computer

To select a computer:

1. Navigate to the desired computer line.
2. Press **Enter**. The selected computer is accessed. A confirmation label appears showing which computer is accessed.

Note! When the OSD is displayed you cannot select computers using the front panel Select buttons or the keyboard hotkeys.

20. The OSD settings (F2)

Press **F2**. The OSD Settings window appears see Figure 9.

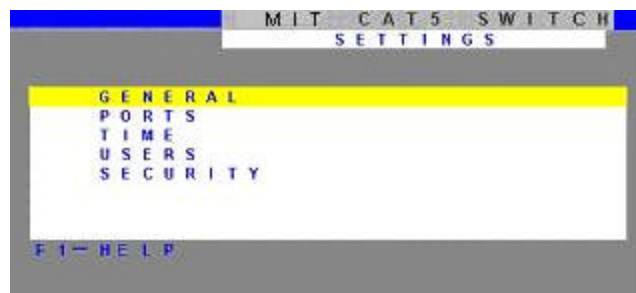

Figure 9 The Settings window

Note! When the OSD is password protected (explained below) only the Administrator has access to the F2 settings window.

21. The General settings

With the blue line on the word GENERAL, press **Enter**. The General settings window appears see Figure 10.

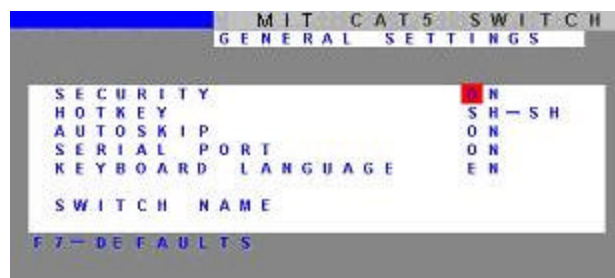

Figure 10 The General Settings window

From this window you can do the following:

Security

The OSD comes with an advanced password security system that contains 3 different security levels. Each security level has different access rights to the system.

These levels are as follows:

Administrator (Status A)

The Administrator can:

- Set and modify all Passwords and security profiles
- Fully access any computer
- Use all OSD functions

Supervisor (Status S)

The Supervisor can:

- Fully access any computer
- Access the following OSD functions only –**F4** Scan, **F5** Tune and **F6** Moving the Confirmation label.

User (Status U)

There are 6 different Users in the CAT5 KVM system. Each User has a Profile set by the Administrator that defines the access level to different computers. There are 3 different access levels, these are explained on page 17.

Activating password protection

By default OSD access is not password protected. Only the Administrator can password-protect the OSD or disable password protection.

To do so:

1. In the General settings window navigate to the Security line.
2. Press the Space bar to toggle between Security On and Off. The password box appears.
3. Type the Administrator's password (default is "admin").
4. Press **Enter**. The new security status is set.

Changing the OSD hotkey

By pressing **Shift, Shift** the OSD appears. You can replace **Shift, Shift** with any of the following:

- Ctrl, Ctrl
- Ctrl, F11
- Print Screen

To change the hotkey:

1. Navigate to the Hotkey line.

2. Press the Space bar to toggle between options. To display the OSD in future press the new hotkey.

Autoskip

With the Autoskip feature, the arrow keys only access the active computer lines on the OSD. When Autoskip is Off, The arrow keys access both active and inactive computer lines.

To change the Autoskip setting:

1. Navigate to the Autoskip line.
2. Toggle between the options using the Space bar.

Serial port

The Serial port is used for the Control Management program. Serial port On means the program can be used.

To change the Serial port setting:

1. Navigate to the Serial port line.
2. Toggle between the options using the Space bar.

Changing the Keyboard language

The keyboard is preset to US English, this can be changed to French (FR) or German (DE), as follows:

1. Navigate to the Keyboard language line.
2. Toggle between the options using the Space bar.

Editing the Switch name

You can substitute up to 18 characters in the line. A space constitutes a character. When there is more than one switch in the system give each Switch's Osd a different name.

22. F7 Defaults

Press F7 to return the OSD to the factory default settings. Note! All changes made will be removed.

23. The Ports settings

In the Settings window navigate to the Ports line and press **Enter**. The Ports settings window appears see Figure 11.

MIT CAT5 SWITCH					
PORTS			SETTINGS		
	NAME		KB	HKEY	
01	COMPUTER	01	PS	NO	
02	COMPUTER	02	U1	NO	
03	SWITCH	03	PS	CLF 1 1	
04	COMPUTER	04	PS	NO	
05	COMPUTER	05	U2	NO	
06	COMPUTER	06	U3	NO	
07	COMPUTER	07	PS	NO	
08	COMPUTER	08	PS	NO	

Figure 11 Ports Settings window

Editing the computer name

In this window you can edit the computer names with up to 15 characters.

To erase a character:

Select it and press the **Space bar**. Blank spaces remain in place of the erased character.

To erase an entire line:

Place the cursor at the beginning of the line. Keep the **Space bar** depressed until the line is erased.

Keyboard (KB)

The CAT5 KVM operates with Windows, Linux, HP UX, Alpha UNIX SGI, DOS, Novell, MAC, USB or Open VMS.

By default the keyboard mode is set to PS for Intel based computers.

For the other systems set the KB column as follows:

- U1 for HP UX
- U2 for Alpha UNIX, SGI, Open VMS
- U3 for IBM AIX

Adding/changing a hotkey (HKEY)

Cascade the CAT5 KVM by connecting another Multi-Platform CAT5 KVM to a Computer port instead of a computer, and then connecting more CIMs to the second Switch. Connect a third and fourth Switch in the same way. With the CAT5 KVM 16 Port model, connect up to up to 256 computers through cascading.

You must define a hotkey to display the OSD of each Switch. These hotkeys must be different for the top and bottom layers. The hotkeys can be any of the choices as set out above on page 14.

To add/change a hotkey:

1. On the line to which the Switch is connected, press Tab to jump to the HKEY column.
2. Toggle between the options using the Space bar.

24. The Time settings

In the Settings window navigate to the Time line and press **Enter**. The Time settings window appears see Figure 12.

	NAME		SCN	LBL	T/O
0 1	COMPUTER	0 1	0 3 0	3 0	0 3 0
0 2	COMPUTER	0 2	0 3 0	0 3 0	0 3 0
0 3	COMPUTER	0 3	0 3 0	0 3 0	0 3 0
0 4	COMPUTER	0 4	0 3 0	0 3 0	0 3 0
0 5	COMPUTER	0 5	0 3 0	0 3 0	0 3 0
0 6	COMPUTER	0 6	0 3 0	0 3 0	0 3 0
0 7	COMPUTER	0 7	0 3 0	0 3 0	0 3 0
0 8	COMPUTER	0 8	0 3 0	0 3 0	0 3 0

Figure 12 Time settings window

Scan (SCN) - Label (LBL) - Time out (T/O)

SCN SCN column, change the scan period.

LBL - In the **LBL** column, change the display period of the OSD label showing which computer is currently accessed.

T/O - When password protection is activated you can automatically disable the Management keyboard, mouse and screen after a preset time of non-use. Set this Timeout period in the **T/O** column.

To set the above periods:

1. On the desired line press Tab to jump to the desired column.
2. Place the cursor over one of the 3 digits and type a new number. Enter a leading zero where necessary. For example, type 040 for 40 seconds.

Typing 999 in the **LBL** column displays the label continuously. Typing 000 – the label will not appear.

Typing 999 in the **T/O** column disables the Timeout function. Typing 000 – the Timeout function works immediately.

Typing 999 in the **SCN** displays the screen for 999 seconds. Typing 000 – the computer screen is skipped.

25. Users

In the Settings window navigate to the Users line and press **Enter**. The Users settings window appears see Figure 13.

MIT CAT5 SWITCH									
USERS				SETTINGS					
	NAME			USER					
				1	2	3	4	5	6
01	COMPUTER	01		Y	Y	V	N	V	
02	COMPUTER	02		V	V	V	Y	N	
03	COMPUTER	03		V	V	V	V	V	
04	COMPUTER	04		N	N	N	V	Y	Y
05	COMPUTER	05		V	V	N	N	N	V
06	COMPUTER	06		Y	Y	Y	Y	Y	Y
07	COMPUTER	07		Y	Y	Y	Y	Y	Y
08	COMPUTER	08		Y	Y	Y	Y	Y	Y

Figure 13 The Users settings window

There are 3 different access levels. These are:

- Y – Full access to a particular computer. Plus access to the **F4**, **F5** and **F6** OSD functions
- V – Viewing access only, to a particular computer (No keyboard/mouse functionality)
- N – No access to a particular computer – A TIMEOUT label appears if access is attempted

To give each user the desired access level:

1. Navigate to the desired computer line and User.
2. Toggle between the options using the Space bar.

26. Security

In the Settings window navigate to the Security line and press **Enter**. The Security settings window appears see Figure 14.

MIT CAT5 SWITCH			
SECURITY SETTINGS			
NAME	PASSWORD	T	
ADMINISTRATOR	ADMIN	A	
SUPERVISOR	S	S	
USER	1	U	
USER	2	U	
USER	3	U	
USER	4	U	
USER	5	U	
USER	6	U	

Figure 14 The Security settings window

The 'T' column on the right hand side stands for Type of password.

There can only be 1 Administrator password, 1 Supervisor password, and 6 User passwords.

To change a user name or password:

1. Navigate to the desired line and column.
2. Type a new user name / password. User authentication is done solely via the password there is no security significance to the names.

By default the User Profile settings are full access.

27. The OSD HELP window – F1

To access the HELP window press F1. The HELP window appears, see Figure 15.



Figure 15 The HELP window

Please note! All the functions set out in the Help window are performed from the Main window. The Help window is merely a reminder of the hotkeys and their functions.

28. Scanning computers– F4

Where necessary adjust the scan time in the Time Settings window, see above.

To activate scanning:

1. Press **Shift** twice to open the OSD.
2. Press **F4**. Your screen displays each active computer sequentially, with the Scan label appearing in the top left corner.

To deactivate scanning:

Press **F4**.

29. Tuning – F5

You can tune the image of any remote computer screen from the Select Computer window.

To adjust the screen image:

1. Navigate to the remote computer you wish to adjust.
2. Press **F5**. The screen image of the selected computer appears, together with the Image Tuning label.

3. Adjust the image by using the **RightLeft** Arrow keys.
4. When the image is satisfactory, press **Esc**.

Note! Picture quality is relative to distance. The further away a remote computer is from the CAT5 KVM, the lower the image quality, and the more tuning needed. So place the higher resolution computers closer to the manager unit.

30. Moving the label – F6

Position the OSD label anywhere on the screen.

To position the label from the Main window:

1. Navigate to the desired computer using the **Up** and **Down** arrow keys.
2. Press **F6**. The selected screen image and Identification label will appear.
3. Use the arrow keys to move the label to the desired position.
4. Press **Esc** to save and exit.

31. Using the Control software

As an alternative to the OSD you can operate the CAT5 KVM system with the Control software located on the Marketing & Documentation CD. With the OSD you operate the system and view the computer screens on the same monitor. The Control software requires 2 monitors 1 for the software and 1 to view the computer screens.

With the Control software you can:

- View computers
- Edit OSD settings
- Save configurations for future use
- Read configurations from and write configurations to the Multi-Platform CAT5 KVM

32. Control software system requirements

- Pentium 166 or higher computer
- 16Mb RAM
- Windows 98, NT4 (SP6), 2000, ME, XP or 2003 server

- Free Serial port

33. Connecting the RS232 Serial cable

To run the software, connect the RS232 Serial cable to the computer containing the software, and to the CAT5 KVM. See the figure below.

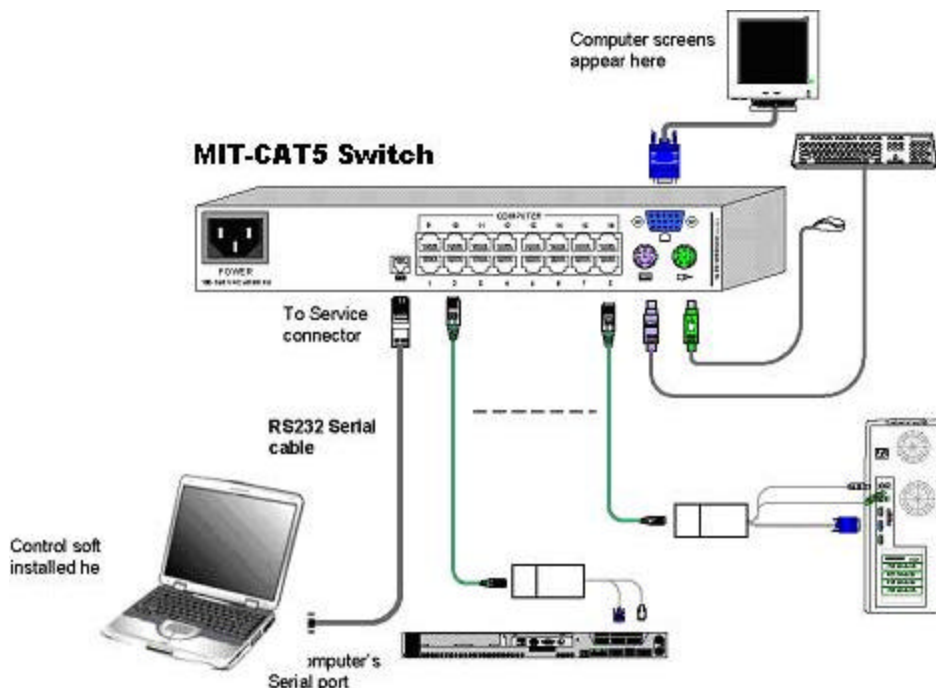

Figure 16 Connecting the RS232 Serial cable

34. Installing and running the Control software

Note! The CAT5 KVM system must be fully connected **BEFORE** running the Control software. Failure to first connect the system will lead to the software working in demo mode.

Start the Marketing & Documentation CD and choose Multi-Platform CAT5 KVM Softpack. The Multi-Platform CAT5 KVM Softpack window appears.

To install the software choose **Install CAT5 KVM RS232 Control Software**. Once the software is installed, a shortcut icon appears on the Desktop .

To run the software double-click the icon.

Or choose Start / Programs / CAT5 KVM RS232 Control / CAT5 KVM RS232 Control.

To run the software from the CD:

Choose Run CAT5 Smart switch RS232 Control Software from CD.

Selecting a Com port

During the Setup process you will be prompted to choose a Com port. Choose the Com port to

which the RS232 Serial cable is connected. Failure to select the correct Com port will result in the software running in demo mode.

Once Setup is complete the Control window appears. See the figure below.

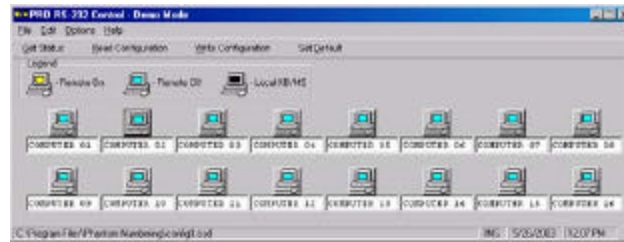

Figure 17 The Control window

35. Computer icons

Icon Meaning



Computer is connected and switched on



Computer is switched off or unconnected



Connected and switched on computer with a Local . After remaining idle for the Timeout period, it changes to **yellow**.

When you first open the Control window the software automatically gets the status of the CAT5 KVM system, including the security access settings.

36. Communication Error

If a Communication Error box appears when trying to scan the system – see Figure 18.



Figure 18 Communication Error

Check that:

- The RS232 Serial cable is connected to the computer's and CAT5 KVM Manager's serial ports.
- The Com Port settings in **Options / Com Port** are set correctly. After changing the Com port exit and re-enter the Control software.

37. The View menu

From the **View** menu choose to display:

- All computers, or only active switched on computers.
- The Legend
- The toolbar

38. Selecting a computer

To select a computer:

Click on the computers icon. The system switches to that computer. The connected icon appears

with a red background . Control and monitor the selected computer from the keyboard and mouse connected to the CAT5 KVM.

39. The toolbar buttons

The toolbar buttons are explained below.

40. Get Status

If for whatever reason there is a break in communication between the Control software and the CAT5 KVM system, click  to get the current status of the computers in system. The system automatically updates the status before every switching.

41. Read Configuration

To see the current settings of the entire CAT5 KVM system (names, scan settings etc.) click . All current settings are received. You view the computer settings from the Control window and other settings from the **Edit** menu – discussed below.

42. Write Configuration

With the Control software you can make changes to all OSD settings. You can then save these configurations in a file to use in the future by selecting **SaveSaveAs** from the **File** menu.

Note! SaveorSaveAs will have no affect on the OSD.

To change the OSD settings you must press **Write Configuration** or choose Write Configuration from the **File** menu after making changes. The changes will then be sent to the CAT5 KVM Manager, and the OSD will reflect these changes.

Renaming a computer

To rename a computer:

1. Type the new name in the box below the computer icon.
2. Click **Write Configuration** to send the new name to the CAT5 KVM system.

Or click **SaveSaveAs** from the **File** menu to save the change in a file and not alter the OSD names.

The Edit menu

You can edit all OSD fields. Edit the following from the Edit menu.

- Logo
- Passwords
- Settings

Logo and Passwords

You can edit the logo that appears at the top of the OSD window. You can also edit the names and passwords for the Administrator, Supervisor and 6 Users.

1. Edit the Logo and Passwords by choosing them from the Edit menu. See figures below.



Figure 19 The logo



Figure 20 The names and passwords

2. Make the desired changes.
3. Click **OK**.

Settings

Choose Settings from the Edit menu. The Computers' Properties box appears. See Figure 21.

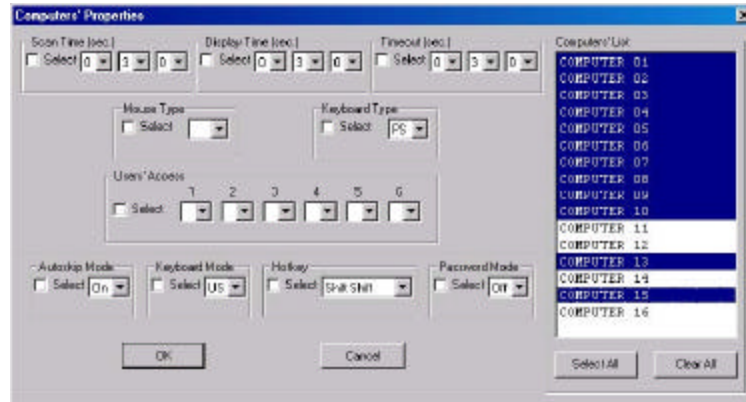

Figure 21 The Settings box

Here you can edit all the data that can be edited in the OSD. This includes:

Scan times, Confirmation label display time, Timeout, mouse type, keyboard type, User access, password mode, Autoskip mode, keyboard mode – Display hotkey.

To edit a setting:

1. Select the desired computer or group of computers.
2. Make the desired changes.
3. Check the Select box next to the changed setting.
4. Click **OK**.

Single computer settings

To see all the settings of a single computer right click on the computer icon. The settings appear as in the figure below.

Note! There is no Select box to check.



Figure 22 The single computer Settings box

43. Loading a saved configuration

To load a saved configuration:

From the **File** menu choose **Open**.

44. The factory default settings

To view to the factory default settings:

From the **File** menu choose **New**.

45. Reminder!

All changes done with the Control software are only reflected in the OSD **AFTER** pressing

Write Configuration .

46. Password protection

When the CAT5 KVM system is password protected, the Control software behaves in exactly the same way as the OSD. You must type in the required password to access the Control software. The access you gain depends on the security status – exactly as with the OSD.

To change the security access, close and reopen the Control software, and type in the different password.

Administrator (Status A)

The Administrator can:

- Set and modify all Passwords and security profiles
- Fully access any computer
- Use all functions

Supervisor (Status S)

The Supervisor can:

- Fully access any computer
- Scan computers.

User (Status U)

There are 6 different Users in the CAT5 KVM system. Each User has a Profile that defines the access level to different computers. There are 3 different access levels. These are:

- Y – Full access to a particular computer
- V – Viewing access only, to a particular computer (No keyboard/mouse functionality)
- N – No access to a particular computer

The Administrator defines the desired access levels of each User Profile. This is done in the Setting box. By default the User Profile settings are full access.

47. Upgrading the CAT5 KVM firmware

With the CAT5 KVM Update software program you can upgrade the firmware for the:

- OSD
- Manager
- CIMs

CAT5 KVM Update enables you to add new features and fix bugs in a quick and efficient manner. You can install the Multi-Platform CAT5 KVM Update on any computer, even one not part of the CAT5 KVM system.

The CAT5 KVM Update software and latest firmware is on the Marketing & Documentation CD. To obtain the latest firmware for your system go to www.ConnectPRO.com .

48. System requirements for the CAT5 KVM Update software

- Pentium 166 or higher with 16 MB RAM and 10 MB free Hard Drive space.
- Available Serial port.
- Windows 98, 2000, ME, XP or Windows NT 4.0 SP (service pack) 3 or later.

49. Connecting the CAT5 KVM System

To update the firmware the CAT5 KVM system must be connected and switched on.

50. Connecting the RS232 Serial cable

To run the software, connect the RS232 Serial cable to the computer containing the software, and to the Multi-Platform CAT5 KVM. See page 21.

51. Installing the software

To install the Multi-Platform CAT5 KVM Update software:

1. Insert the Marketing & Documentation CD. The CD menu runs automatically.

2. Choose Multi-Platform CAT5 KVM Softpack.
3. Either run the Multi-Platform CAT5 KVMUpdate software straight from the CD or install it on the computer's hard drive and run it from there.

52. Starting and configuring the CAT5 KVM Update

1. Start the CAT5 KVM Update software. The CAT5 KVM Update window appears. See Figure 23.

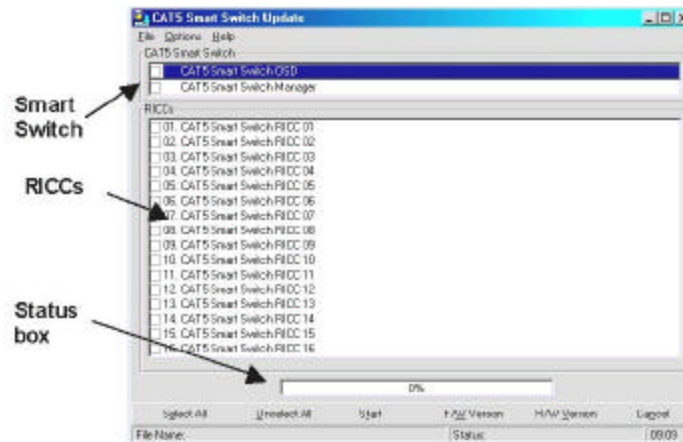

Figure 23 The Multi-Platform CAT5 KVM Update window

The table below explains the functions of the buttons and boxes in the Multi-Platform CAT5 KVM Update window.

Button or Box	Function
Select All	Selects all CIMs
Unselect All	Unselects selected CIMs
Start	Starts firmware download
F/W Version	Displays the firmware version number
H/W Version	Displays the hardware version number
Cancel	Cancel selected function
10:06	System time
Status:	Displays download status
File Name:	Name of Update file

2. From the Options menu choose Com Port. The Com Port box appears.

See Figure 24.



Figure 24 The Com Option box

3. Choose an available Com Port and click OK.

Note! The RS232 Serial cable must be connected to the selected Serial port.

53. Verifying the version numbers

Before upgrading the firmware, you must first verify which firmware and hardware versions you have.

The OSD version number

To verify the OSD version number:

1. Open the Multi-Platform CAT5 KVM Update program.
2. In the **Switch Unit** box, check the OSD option. See Figure 23.
3. Click **F/W Version** . The version number appears in the **Switch** box.

The H/W Version button is grayed out, as there is no hardware relevant to the OSD.

The CAT5 KVM Manager version number

To verify the CAT5 KVM version number:

1. Open the Multi-Platform CAT5 KVM Update program.
2. In the **Switch Unit** box, check the **CAT5 KVM Manager** option.
3. Click **F/W Version** . The firmware version number appears in the **Switch Unit** box.
4. Click **H/W Version** . The hardware version number appears in the **Switch Unit** box.

Verifying the CIM version number

Before you can check a CIM, you must uncheck the **Switch Unit** box options.

To verify the CIM version number:

1. Open the Multi-Platform CAT5 KVM Update program.
2. Check one or more or all of the CIMs.
3. Click **F/W Version** . The firmware version number appears after the CIM number.

4. Click **H/WVersion** . The hardware version number appears after the CIM number.
When “**Not responding**” appears, there is no computer connected, or it is switched off.

54. Obtaining new firmware

Download the latest firmware for your system from www.ConnectPRO.com

55. Updating the firmware

Warning!

Never switch off any computer connected to the CAT5 KVM system during the updating process.

To update the firmware:

1. Open the Multi-Platform CAT5 KVM Update program.
2. In the Multi-Platform CAT5 KVM Update window, check the appropriate option in the **Switch Unit** box or the desired CIM.
3. From the **File** menu, choose **Open**. The **Open** box appears. See Figure 25.
4. Navigate to the folder that contains the firmware update file. You may only see the files that match the file selection mask.

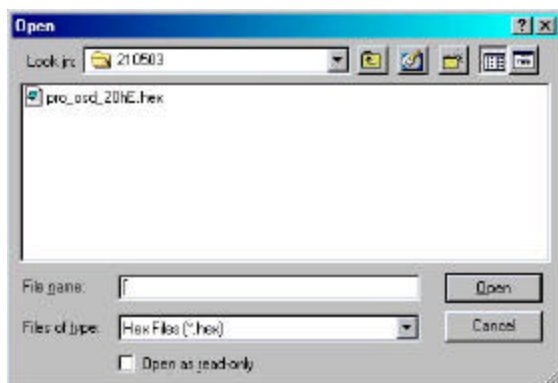

Figure 25 The Open box

5. Open the file.
6. Click **Start**. The Multi-Platform CAT5 KVM Update flashes the firmware. On completion the firmware version number appears.
7. Check that the updated version number is correct by pressing **F/WVersion** .

Firmware Update generates one log file per session that displays a chronological list of actions. You can read the log file in any ASCII text editor. The log file is located in the Windows directory.

56. Reset

Reset the software for the CAT5 KVM Manager or CIMs when for example the unit hangs or when

the mouse fails to work properly. Resetting is done via the Serial port, and avoids the need to shut down the computer.

NOTE! The Reset function does not affect the parameters of the unit settings.

Resetting the Switch or CIM units

To reset the Switch or CIM units:

1. For the Switch, check the Multi-Platform CAT5 KVM option in the **Switch Unit** box.
For the CIMs, check one or more CIMs in the **CIM Units** box.
2. From the Options menu choose **Advanced / Reset**. The units reset. The system should now be operational.

57. Troubleshooting tips

When using Firmware Update software you may sometimes get a Communication Error message.

When updating a unit and a Communication Error message appears, do the following:

1. Check that the RS232 Serial cable's RS232 connector is connected to the Switch's Communication port.
2. Check that the RS232 Serial cable's DB9F connector is connected to the DB9M Serial port on the CPU's rear panel.
3. Restart the download process.

Electricity failure

If the electricity fails while updating the CAT5 KVM firmware, do the following:

If the electricity fails during the firmware update of the Switch, a **Communication Error** message appears. Simply resume the firmware update by opening the folder that contains the firmware update file and continue from there.

If the electricity fails during the firmware update of the CIMs a **Not Responding or Upgrade Error** message appears. Restart the upgrade from the beginning.

58. USB SUN Combo keys

The connected PS/2 keyboard does not have a special SUN keypad to perform special functions in the SUN Operating System environment. So when a CIM USB or SUN is connected to a SUN computer, the CIM emulates these SUN keys using a set of key combinations called Combo keys. See the table below.

SUN key	Combo key
Stop	Left Ctrl + Alt + F1
Props	Left Ctrl + Alt + F3
Front	Left Ctrl + Alt + F5
Open	Left Ctrl + Alt + F7

Find	Left Ctrl + Alt + F9
Again	Left Ctrl + Alt + F2
Undo	Left Ctrl + Alt + F4
Copy	Left Ctrl + Alt + F6
Paste	Left Ctrl + Alt + F8
Cut	Left Ctrl + Alt + F10
Help	Left Ctrl + Alt + F11
Compose	Application key or Left Ctrl + Alt + Keypad *
Crescent	Scroll Lock
Volume Up	Left Ctrl + Alt + Keypad –
Volume Down	Left Ctrl + Alt + Keypad +
Mute	Left Ctrl + Alt + F12
Sun Left ? key	Left Windows key
Sun Right ? key	Right Windows key
Alt-Graph	Right Alt or Alt Gr
Stop A	Left Ctrl + Alt + 1

59. Technical specifications

Operating Systems DOS, Windows (3X, 9X, 2000, NT4, ME, XP)
LINUX, UNIX, QNX, SGI, FreeBSD, BeOS, Open VMS, Novell 3.12-6

Local Mouse Driver PS/2, wheel mouse

Resolution 1600x1200@75Hz

Transmission distance Up to 10m/33ft

Multi-Platform CAT5 KVM

Dimensions – 8/16 266.5 x 110.5 x 41.3mm / 10.47 x 4.35 x 1.62in

Weight – 8/16 port Product – 1Kg / 2.2lbs
Shipping – 1.95Kg / 4.22lbs

Power supply – 8/16 port Internal switching 85-260 VAC 50 / 60 Hz

Connections

System	RJ45
Local KVM	RJ11
	HDD15/MiniDin6/MiniDin6
Operating temperature	0°C to 40°C/32°F to 104°F
Storage temperature	-40°C to 70°C/-40°F to 158°F
Humidity	80% non-condensing relative humidity

CIMs	PS/2	USB	SUN
Connections			
VGA	HDD15	HDD15	HDD15
Keyboard/Mouse	MiniDin6	USB	MiniDin6
System	RJ45	RJ45	RJ45
Power	From computer's	From USB port	From computer's
Product weight		107g	
Shipping weight		300g	
Dimensions	91 x 41 x 24mm / 3.58 x 1.61 x 0.94in		



Free Manuals Download Website

<http://myh66.com>

<http://usermanuals.us>

<http://www.somanuals.com>

<http://www.4manuals.cc>

<http://www.manual-lib.com>

<http://www.404manual.com>

<http://www.luxmanual.com>

<http://aubethermostatmanual.com>

Golf course search by state

<http://golfingnear.com>

Email search by domain

<http://emailbydomain.com>

Auto manuals search

<http://auto.somanuals.com>

TV manuals search

<http://tv.somanuals.com>