

# **OWNER'S INSTRUCTION MANUAL**

**DECT 6  
CORDLESS TELEPHONE  
MODEL 8012**

**CORTELCO**

# Contents

<b>Important Safety Instructions .....</b>	<b>8</b>
<b>Unpacking and Installation .....</b>	<b>12</b>
<b>Features .....</b>	<b>13</b>
<b>Telephone Part Identification .....</b>	<b>14</b>
<b>Key Descriptions .....</b>	<b>16</b>
<b>Navigation Key .....</b>	<b>17</b>
<b>Installation .....</b>	<b>20</b>
<b>Basic Functions .....</b>	<b>24</b>
<b>Making a Call .....</b>	<b>24</b>
<b>Making a Call - Standby Mode .....</b>	<b>24</b>
<b>Receiving a Call .....</b>	<b>24</b>
<b>Mute .....</b>	<b>25</b>
<b>Volume Control .....</b>	<b>26</b>
<b>Message Waiting .....</b>	<b>26</b>

<b>Ringer Settings</b> .....	<b>26</b>
<b>Last Number Redial</b> .....	<b>28</b>
<b>Redial Book Options</b> .....	<b>29</b>
<b>Caller ID Functions</b> .....	<b>30</b>
<b>Review Caller ID Records</b> .....	<b>30</b>
<b>Dial from CID</b> .....	<b>31</b>
<b>Add CID Number to Phone Book</b> .....	<b>31</b>
<b>Delete a CID Number</b> .....	<b>32</b>
<b>Delete all CID Numbers</b> .....	<b>32</b>
<b>Caller ID on Call Waiting</b> .....	<b>33</b>
<b>Key Lock</b> .....	<b>33</b>
<b>Auto Answer</b> .....	<b>34</b>
<b>Language</b> .....	<b>35</b>
<b>Handset Name</b> .....	<b>36</b>
<b>Range Alarm</b> .....	<b>37</b>
<b>Paging</b> .....	<b>38</b>
<b>Dial Mode</b> .....	<b>38</b>
<b>Handsfree/Speakerphone</b> .....	<b>39</b>

<b>Flash</b> .....	<b>40</b>
<b>Backlight</b> .....	<b>40</b>
<b>Advanced Features</b> .....	<b>41</b>
<b>Menu Navigation</b> .....	<b>41</b>
<b>Standby Mode</b> .....	<b>41</b>
<b>Phone Book</b> .....	<b>42</b>
<b>Character Map</b> .....	<b>42</b>
<b>Adding a Phone Book Entry</b> .....	<b>43</b>
<b>Viewing a Phone Book Entry</b> .....	<b>44</b>
<b>Dialing from a Phone Book Entry</b> .....	<b>44</b>
<b>Editing a Phone Book Entry</b> .....	<b>44</b>
<b>Deleting a Phone Book Entry</b> .....	<b>45</b>
<b>Deleting all Phone Book Entries</b> .....	<b>46</b>
<b>Pause</b> .....	<b>46</b>
<b>Phonebook Status</b> .....	<b>46</b>
<b>Base (BS) Settings</b> .....	<b>47</b>
<b>Terminate HS (Handset)</b> .....	<b>47</b>
<b>Change Flash Time</b> .....	<b>48</b>

<b>Modify PIN .....</b>	<b>49</b>
<b>BS (Base) Reset .....</b>	<b>50</b>
<b>Handset (HS) Settings .....</b>	<b>51</b>
<b>Alarm .....</b>	<b>51</b>
<b>Audio Setup .....</b>	<b>52</b>
<b>Key Tone .....</b>	<b>53</b>
<b>LCD Contrast .....</b>	<b>54</b>
<b>Base Selection .....</b>	<b>55</b>
<b>Date and Time Format .....</b>	<b>56</b>
<b>Setting Date and Time .....</b>	<b>57</b>
<b>HS Reset .....</b>	<b>58</b>
<b>Registration .....</b>	<b>59</b>
<b>Multiple Handset Operation .....</b>	<b>60</b>
<b>Internal Calling .....</b>	<b>60</b>
<b>Call Transfer .....</b>	<b>61</b>
<b>3-Way Conference Call .....</b>	<b>62</b>
<b>Maintenance Information .....</b>	<b>63</b>

<b>Telephone Service Problems .....</b>	<b>63</b>
<b>Technical Specifications .....</b>	<b>64</b>
<b>Troubleshooting .....</b>	<b>65</b>
<b>Troubleshooting (continued) .....</b>	<b>66</b>
<b>Telephone Repair .....</b>	<b>67</b>
<b>Limited Warranty .....</b>	<b>71</b>

**THANK YOU  
FOR PURCHASING THE  
8012 DECT 6  
CORDLESS TELEPHONE**

**We want you to know all about your new telephone**, how to install it, the features it provides, and the services you can expect from its use. We have included this information in your Owner's Instruction Manual.

**PLEASE READ BEFORE INSTALLING AND  
USING YOUR NEW TELEPHONE**

## **Important Safety Instructions**

Always follow basic safety precautions when using your telephone to reduce the risk of fire, electrical shock and injury.

1. Read and understand all instructions.
2. Follow all warnings and instructions marked on the product.
3. Unplug this product from the wall outlet before cleaning. Do not use liquid cleaners or aerosol cleaners. Use a damp cloth for cleaning.
4. Do not use this product near water, for example, near a bath tub, wash bowl, kitchen sink, laundry tub, in a wet basement, or near a swimming pool.
5. Do not place this product on an unstable cart, stand, or table. The product may fall, causing serious damage to the product.
6. Slots and openings in the cabinet and the back or bottom are provided for ventilation. To protect it from overheating, these openings must not be blocked or covered. The openings should never be blocked by placing the product on the bed, sofa, rug, or other similar surface. This product should never be placed near or over a radiator or heat register. This product should not be placed in a built-in installation unless proper ventilation is provided.
7. This product should be operated only from the type of power source indicated on the marking label. If you are not sure of the type of power supply to your home, consult your dealer or local power company.



8. Do not allow anything to rest on the power cord. Do not locate this product where the cord will be damaged by persons walking on it.
9. Do not overload wall outlet extension cords, as this can result in the risk of fire or electric shock.
10. Never push objects of any kind into this product through cabinet slots as they may touch dangerous voltage points or short out parts that could result in a risk of fire or electric shock. Never spill liquid of any kind on this product.
11. To reduce the risk of electric shock, do not disassemble this product. Instead, when some repair work is required, take the unit to a qualified technician. Opening or removing covers may expose you to dangerous voltages or other risks. Incorrect reassembly can cause electric shock when the appliance is subsequently used.
12. Unplug this product from the wall outlet and refer servicing to qualified service personnel under the following conditions:
  - a. When the power supply cord or plug is damaged or frayed.
  - b. If liquid has been spilled into the product.
  - c. If the product has been exposed to rain or water.

- d. If the product does not operate normally by following the operating instructions. Adjust only those controls that are covered by the operating instructions because improper adjustment of other controls may result in damage and will often require extensive work by a qualified technician to restore the product to normal operation.
  - e. If the product has been dropped or cabinet has be damaged.
  - f. If the product exhibits a distinct change in performance.
13. Avoid using a telephone during an electrical storm. There may be a risk of electrical shock from lightning.
  14. Do not use the telephone to report a gas leak in the vicinity of the leak.
  15. Plug the power adaptor into an electrical outlet that is near the equipment and easily accessible.

## **Safety Instructions for Handset Battery Pack**

### **CAUTION:**

There is a danger of explosion if the batteries are incorrectly replaced. Use only approved batteries in the handset of your telephone. To reduce the risk of fire or injury, be careful not to short the batteries with conducting materials such as rings, bracelets, and keys. The batteries or conducting material may overheat and cause burns.

**CONTAINS NICKEL-METAL HYDRIDE BATTERY. BATTERY MUST BE RE-CYCLED OR DISPOSED OF PROPERLY**

1. Do not dispose of the batteries in a fire. They may explode. Check with local codes for possible special disposal instructions.
2. Do not open or mutilate the batteries. Released electrolyte is corrosive and may cause damage to the eyes or skin. It may be toxic if swallowed.
3. Exercise care in handling batteries in order not to short the battery with conducting materials such as rings, bracelets and keys. The battery or conductor may overheat and cause burns.
4. Charge the batteries only in accordance with the instructions and limitations specified in this manual.
5. Observe proper polarity orientation for the batteries as marked in the telephone.
6. Do not mix old and new batteries.
7. Do not mix batteries of different sizes or from different manufacturers.
8. Use only the power supply which came with the phone.

## Unpacking and Installation

### Box Contents

The following items should be packed with your 8012. Please contact your dealer if any of them is missing.

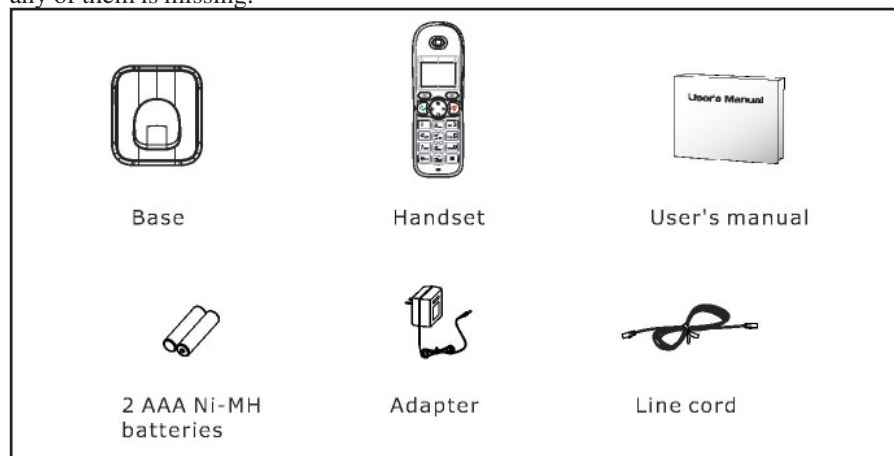

## Features

1.8 GHz DECT Technology with GAP	Call Duration Display
5 Row Backlit Dot Matrix LCD (128 X 64) with Adjustable Contrast	Alarm Clock with Snooze
Lighted Keypad	Out of Range Alarm
Speakerphone	PIN for Security
Receiver/Speaker/Ringer Volume Control	Keypad Lock
Tone/Pulse Dialing	Eight languages
Flash with Selectable Timing	Auto Answer (Optional)
Pause	Handset Name
Mute	Caller ID on Call Waiting
10 Number Redial Memory	40 Entry Caller ID List
50 Entry Name/Number Phonebook	Message Waiting
VIP Ringtones for Phonebook Entries	Up to 5 Handsets Can Register to One Base
10 Ringer Tones	Up to 4 Bases Can Register to One Handset
Selectable Keytone	Internal Calls
Redialing	Call Transfer
Clock	3-way Conference Call

## Telephone Part Identification

### Handset

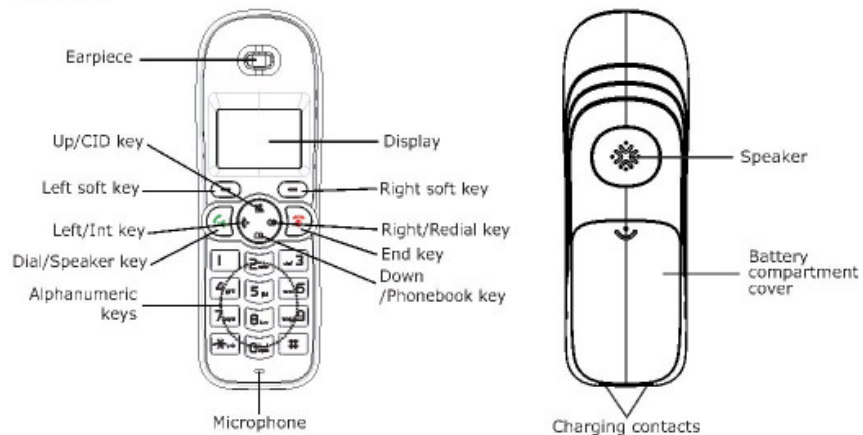

**Base**

**Charge pins**

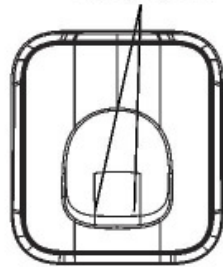

**Rear and bottom View**

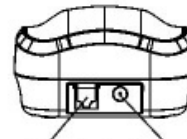

Phone Line Jack Power Jack



Page button

## Key Descriptions



**Dial/Speaker Key** - Used to place or answer a call. If pressed during a call, activates the speakerphone.



**End Key** - End a call. If pressed and held, powers off the handset



**Left/Right Soft Key** - Performs the function indicated by the text immediately over it in the display.

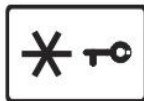

**\*Key** - Press and hold to lock the keypad. Set up a conference call as described on Page 35.



## Navigation Key



**Up/CID Key** - Scrolls up through list and menu options. Increases the receiver or speakerphone volume during a call. Enters the CID book as described on Page 18.

**Down/Phonebook Key** - Scrolls down through list and menu options. Decreases the receiver or speakerphone volume during a call. Enters the phonebook as described on Page 26.

**Left/Int Key** - Set up an intercom call to another handset. Transfer a call to another handset. Set up a conference call with an external line and an intercom handset.

**Right/Redial Key** - Enter the redial book as described in Page 16. Insert a pause when pre-dialing.

## Icons



**New Call** - One or more calls have been received.



**MSG Waiting** - One or more voice messages have been received.



**Off Hook** - The line is in use.



**Speakerphone** - Speakerphone function is in use.



**Alarm** - The alarm is activated.



**Signal** - Indicates the signal strength. Blinks if the handset is too far from the base.



**Battery** - Shows battery charge level



**Keypad Lock** - Keypad is locked.

## Installation

### Line and Power Connection

1. Connect the phone line cord to the telephone line jack in the base. Connect the other end of the line cord to a telephone outlet.
2. Connect the AC power adapter to the base power jack. Plug the AC power adapter into an AC outlet.

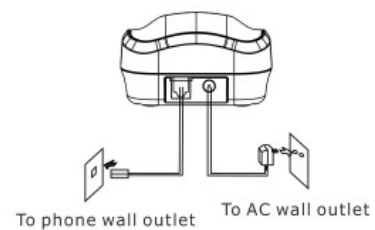

### Battery Installation

Two rechargeable Ni-MH AAA size batteries come with the 8012. These must be installed before use.

1. Slide the battery cover in the direction shown below and remove.
2. Install the batteries as shown below. Care must be taken to install in the correct polarity. **The 8012 may be damaged if batteries are inserted in incorrect polarity.**
3. Reinstall the battery cover.

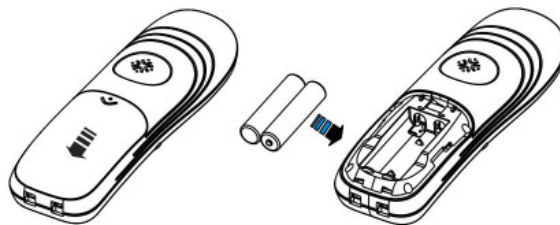

Replace the batteries when they fail to return to a full charge after recharging. Use only Ni-MH rechargeable batteries. Never use other battery types such as alkaline.

### Charging Handset

The handset should be charged for 15 hours before initial use. To charge the handset, place it in the base. If the handset is off, it will automatically turn on.



To turn the handset off, press  until the display turns off.

To turn the handset on, press  until the display turns on.

If the handset is able to find a base, the display will show the handset number, the handset name (if one is assigned), the signal icon, battery icon, and the current time. If the handset cannot find a base, it will display “Searching...”

### DSL Interference

If the 8012 is used on a line with DSL service, it may be necessary to install a noise filter. A filter may be obtained from the DSL provider. It should be used if noise is heard during conversations or Caller ID is not functioning properly.

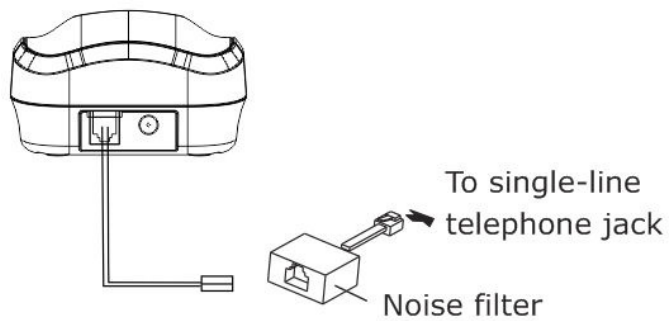



## Basic Functions

### Making a Call

1. Remove the handset from the base and press 
2. Dial the telephone number.

### Making a Call - Standby Mode

1. Enter the telephone number (up to 32 digits). Use  to enter a pause. Use the Erase soft key to correct mistakes.
2. Press  to dial the number.

### Receiving a Call

When a call is received, the **InUse** indicator on the base will blink. Normally, the caller's phone number will be displayed. If the caller cannot be identified, only the **NewCall** information will display.



1. If Auto Answer has been activated and the handset is in the base, lift the handset to answer the call.
2. Otherwise, press  to answer.



**Notes:** After the call is terminated, the display will show the call duration. If a polyphonic ringtone is set, the ringtone may continue for up to 4 seconds after the call is answered at another phone.

To change the ringer volume, press  or  while the phone is ringing.

### **Mute**



During a conversation, the microphone of the 8012 can be muted so that the distant party cannot hear what is being said. To mute the microphone, press the **MUTE** soft key. The display will show “**CALL MUTED.**” To unmute the microphone, press the **MUTE** soft key again.

### **Volume Control**

During a conversation, pressing  or  will adjust the handset receiver or speakerphone volume level. Volume can be adjusted in 5 steps.



### **Message Waiting**





If a voice message is received, the display will show the  icon and “MSG WTG ON “

To deactivate the  icon, press the  key in standby mode, then press and hold the 4 key. Finally, press  to return to standby mode.



### **Ringer Settings**

Perform the following steps to change the ringer tone or volume. These settings can apply to either external calls (from the telephone company) or internal calls (from other handsets registered to the same base).

1. Press the **Menu** soft key.
2. Press  or  to choose **HS Settings**.



3. Press the **Select** soft key.
4. Press  or  to choose **Ring Setup**.
5. Press the **Select** soft key.
6. Press the **Select** soft key to choose **INT Ring**, or press the  key to choose **EXT Ring**.
7. Press the **Select** soft key.
8. Press  or  to choose **Melody or Volume**.
9. Press the **Select** soft key.
10. Choose the desired ring tone (1 - 10) or desired ring volume (1 - 5 or off). The 8012 will play the selected melody or volume level.
11. Press the **Save** soft key to confirm.

### **Last Number Redial**

1. Press  or the **Redial** soft key in standby mode. The display will show the last number dialed.
2. Press  to dial the number.



### **Redial Book**

The 8012 can also retrieve the last 10 numbers dialed and redial them.

1. Press the **Redial** soft key in standby mode.
2. Press  or  to scroll through the list of numbers until the desired number is displayed.
3. Press  to dial the number.

### Redial Book Options

Redial Book Options allows a number to be added to the phone book or deleted from the redial book.





1. Press the **Redial** soft key in standby mode.
2. Press  or  to scroll through the list of numbers until the desired number is displayed.
3. Press the **More** soft key to choose the desired option.  
**Add to PB** allows the number to be added to the phonebook.  
**Delete** removes the selected number from the redial book.  
**Delete All** removes all numbers from the redial book.  
If **Delete** or **Delete All** are selected, the display will show “**Confirm ?**” To confirm, press the **Del** or **Del All** soft key. To cancel, press the **Cancel** soft key.
4. Press  to return to standby mode.

### Caller ID Functions

When a call is received, the 8012 will normally display the name and number of the caller. If the caller has chosen to prevent his information from being transmitted, the display will show “**Private.**” If information cannot be received for some other reason, the display will show “**Out Of Area.**”

If a call is missed, the  icon will show on the display. If the Caller ID memory is full, the  icon will flash.

### Review Caller ID Records



1. Press the **Menu** soft key.
2. Using the **Select** soft key, choose the **CID Book**. CID numbers will be displayed. The CID Book may also be accessed by pressing  in standby mode.
3. Use  or  to review the numbers. Each number which has been reviewed is marked with . Calls which have not been reviewed are marked with







### **Dial from CID**

Follow the steps above for reviewing Caller ID Records. When the desired number is displayed, press  to dial.



### **Add CID Number to Phone Book**

1. Press the **Menu** soft key.
2. Using the **Select** soft key, choose the **CID Book**.
3. Use  or  to review the numbers.
4. When the desired number is displayed, press the **Menu** soft key to enter the **Add to PB** menu.
5. Press the **Select** soft key. A prompt for the name will appear.
6. Enter the name and press the **Next** soft key.
7. Edit the number if necessary.
8. Press the **Next** soft key.
9. Select the ring tone (1 - 10).
10. Press the **Save** soft key. A beep will sound to confirm.

### **Delete a CID Number**

1. Press the **Menu** soft key.
2. Using the **Select** soft key, choose the **CID Book**.
3. Use  or  to review the numbers.
4. When the desired number is displayed, press the **More** soft key.
5. Use  or  to choose **Delete**.
6. Press the **Select** soft key.
7. When the display shows **Confirm ?**, press the **Del** soft key.
8. A beep will sound to confirm and the next number will be displayed.

### **Delete all CID Numbers**

1. Press the **Menu** soft key.
2. Using the **Select** soft key, choose the **CID Book**.
3. Press the **More** soft key.
4. Use  or  to choose **Delete All**.
6. Press the **Select** soft key.





7. When the display shows **Confirm ?**, press the **Del All** soft key.
8. A beep will sound to confirm and the 8012 will return to standby mode.

### **Caller ID on Call Waiting**

This service allows the number of a calling party to be displayed while on another call. When the number of the second caller is displayed, press the **Flash** soft key to answer. To return to the first caller, press the **Flash** soft key again.

### **Key Lock**







Activating this feature causes the keypad to be disabled, but allows calls to be answered.

**To lock the keys** in the standby mode, press  until the display shows **HS Locked**. The key icon  will also appear.

**To unlock the keys** in the standby mode, press  until the key icon disappears.







### **Auto Answer**

Activating Auto Answer allows calls to be answered by simply removing the handset from the base. To activate Auto Answer:

1. Press the **Menu** soft key.
2. Press  or  repeatedly to choose **HS Settings**.
3. Press the **Select** soft key.
4. Use  or  to choose **Auto Answer**.
5. Press the **Select** soft key.
6. Use  or  to choose **On/Off** to enable or disable the function.
7. Press the **Save** soft key.
8. A beep will sound to confirm.





## Language

The 8012 supports 8 languages: English, French, Spanish, German, Italian, Dutch, Polish, and Traditional Chinese. To select a language:

1. Press the **Menu** soft key.
2. Press  or  repeatedly to choose **HS Settings**.
3. Press the **Select** soft key.
4. Use  or  to choose **Language**.
5. Press the **Select** soft key.
6. Use  or  to scroll through the languages.
7. When the desired language is displayed press the **Save** soft key.
8. A beep will sound to confirm.







### Handset Name

The 8012 handset can be given a name. This is useful if more than one handset is registered to a base. To set the handset name:

1. Press the **Menu** soft key.
2. Press  or  repeatedly to choose **HS Settings**.
3. Press the **Select** soft key.
4. Use  or  to choose **HS Name**.
5. Press the **Select** soft key.
6. Enter the name (up to 12 characters) using the keypad. Use the **Erase** soft key to correct any mistakes.
7. Press the **Save** soft key.
8. The handset name will display above the handset number in standby mode.

### Range Alarm

Normally a beep will sound whenever the handset moves out of range of the base. This feature may be enabled or disabled.

1. Press the **Menu** soft key.
2. Press  or  repeatedly to choose **HS Settings**.
3. Press the **Select** soft key.
4. Use  or  to choose **Tone Setup**.
5. Press the **Select** soft key.
6. Use  or  to choose **On/Off** to enable or disable the function.
7. Press the **Save** soft key.
8. A beep will sound to confirm.

## Paging

The handset can be paged from the base. This is useful to locate a lost handset.



**To Page** press the  key on the base. All handsets registered to the base will ring for approximately 60 seconds.



**To Stop Paging** press the  key again or press any key on the handset.

**Note:** Pressing the  key for more than 5 seconds will put the base into registration mode. See Page 33.

## Dial Mode

The 8012 supports DTMF or Pulse dialing. To change the dial mode:

1. Press the **Menu** soft key.
2. Press  or  repeatedly to choose **BS Settings**.
3. Press the **Select** soft key.
4. Use  to choose **Dial Mode**.

5. Press the **Select** soft key.
6. Press  or  to select the desired dial mode (**Tone/Pulse**).
7. Press the **Save** soft key.
8. A beep will sound to confirm.

### **Handsfree/Speakerphone**

During a call, the speakerphone may be activated.

**To Activate Handsfree** press . The  will appear in the display.

**To Deactivate Handsfree** press  again. The  will disappear from the display.

**Caution:** Be sure the speakerphone is deactivated before putting the handset near your ears.

### **Flash**

The Flash key sends a timed line break. This signal is used to activate some special services such as call waiting. The services available will depend on the telephone company. To send a flash, press the **Flash** soft key while the phone is active. The display will show **R**.



### **Backlight**

In standby mode, press  to toggle the backlight.



## Advanced Features

### Menu Navigation

1. Press the **Menu** soft key.
2. Press  or  repeatedly to scroll through menu options.
3. Press the **Select** soft key to select a menu.
4. Repeat scrolling and selecting if necessary.

Press the **Back** soft key from any menu to return to the previous screen.

### Standby Mode



Press  to return to standby mode. The 8012 will also return to standby mode if no key is pressed for 40 seconds.

## Phone Book Character Map

Characters are entered by pressing the keypad. The chart below shows the characters that are generated by repeatedly pressing the keys.



Key	Character								
0	spc	0	?	&	/	.	,	!	
1	1	@	_	+	-	"	(	)	%
2	A	B	C	a	b	c	2		
3	D	E	F	d	e	f	3		
4	G	H	I	g	h	i	4		
5	J	K	L	j	k	l	5		
6	M	N	O	m	n	o	6		
7	P	Q	R	S	p	q	r	s	7
8	T	U	V	t	u	v	8		
9	W	X	Y	Z	w	x	y	z	9

### Adding a Phone Book Entry

1. Press the **Menu** soft key.
2. Press  to choose **Phonebook**.
3. Press the **Select** soft key to choose **New**.
4. The display shows “**Name ?**”. Enter the name using the keypad.
5. Press the **Next** soft key.
6. Enter the name and press the **Next** soft key.
7. The display shows “**Number ?**”. Enter the number (up to 20 digits) using the keypad.
8. Press the **Next** soft key.
9. Use  or  to select the ring tone (1 - 10).
10. Press the **Save** soft key.

**Note:** Mistakes may be corrected by using the **Erase** soft key.





### Viewing a Phone Book Entry



1. In standby mode, press .
2. Press  or  repeatedly until the desired entry is displayed.

### Dialing from a Phone Book Entry





After viewing the desired number as described above, press  or the **Dial** soft key.

### Editing a Phone Book Entry



1. Press the **Menu** soft key.
2. Press  to choose **Phonebook**.
3. Press the **Select** soft key.
4. Press  to choose the **Edit** menu.
5. Press the **Select** soft key.
6. Press  or  repeatedly until the desired entry is displayed.

7. Press the **Select** soft key.
8. Edit the entry using the **Erase** soft key as needed.
9. Press the **Next** soft key to save.
10. Use  or  to select the ring tone (1 - 10).
11. Press the **Save** soft key.

### **Deleting a Phone Book Entry**

1. Press the **Menu** soft key.
2. Press  to choose **Phonebook**.
3. Press the **Select** soft key.
4. Press  or  to choose **Delete**.
5. Press the **Select** soft key.
6. Press  or  repeatedly until the desired entry is displayed.
7. Press the **Select** soft key. The display shows “**Confirm ?**”
8. Press the **Del** soft key to delete. Press **Cancel** to exit.

### Deleting all Phone Book Entries

1. Press the **Menu** soft key.
2. Press  to choose **Phonebook**.
3. Press the **Select** soft key.
4. Press  or  to choose **Delete All**.
5. Press the **Select** soft key.
6. Press the **Select** soft key. The display shows “**Confirm ?**”
8. Press the **Del All** soft key to delete. Press **Cancel** to exit.

### Pause

A pause provides a delay of 3 seconds. It is often necessary to use this when accessing an interactive voice response system such as automated banking. To insert a pause in a number to be dialed, press . The letter **P** will show in the display.





### Phonebook Status

Phonebook status shows the number of entries stored in the phonebook. To display this, press the **Select** soft key when **PB Status** is displayed.

## Base (BS) Settings







### Terminate HS (Handset)

This allows a handset registration to be deleted from the base.

1. Press the **Menu** soft key.
2. Press  or  to select **BS Settings**.
3. Press the **Select** soft key.
4. Press the **Select** soft key again to select the **Termnate HS** menu. The display shows “**PIN ?**”
5. Enter the PIN Code. The default is 0000.
6. Press the **OK** soft key.
7. Press  or  to select a handset. A warning beep will sound if the current handset or a non-existent handset is selected.
8. Press the **Select** soft key. The handset is unregistered.

### Change Flash Time





**Note:** The default flash time is correct for almost all phone systems used in North America.

1. Press the **Menu** soft key.
2. Press  or  to select **BS Settings**.
3. Press the **Select** soft key.
4. Press  or  to choose the **Flash Time** menu.
5. Press the **Select** soft key.
6. The display will show the current setting.
7. Press  or  to select **Flash-1/Flash-2**.
8. Press the **Save** soft key.







## Modify PIN

The default PIN is 0000. If security is a concern, this can be changed.

1. Press the **Menu** soft key.
2. Press  or  to select **BS Settings**.
3. Press the **Select** soft key.
4. Press  or  to choose the **Modify PIN** menu.
5. Press the **Select** soft key. The display shows “**PIN ?**”
6. Enter the current PIN Code.
7. Press the **Next** soft key. If the current PIN is correct, a prompt for the new PIN will appear. Otherwise, a warning beep will sound and the handset will return to the **Modify PIN** menu.
8. Enter the new PIN Code.
9. Press the **Next** soft key. A prompt will appear to confirm the new PIN code.

### **BS (Base) Reset**







This will restore all settings to factory default.

1. Press the **Menu** soft key.
2. Press  or  to select **BS Settings**.
3. Press the **Select** soft key.
4. Press  or  to choose the **BS Reset** menu.
5. Press the **Select** soft key. The display shows “**PIN ?**”
6. Enter the PIN Code.
7. Press the **Reset** soft key. If the PIN is correct, all base settings will be reset. If not, a warning tone will sound and all base settings will remain the same.

**Note:** After resetting, the handset will return to standby mode.

## Handset (HS) Settings

### Alarm







1. Press the **Menu** soft key.
2. Press  or  to select **HS Settings**.
3. Press the **Select** soft key.
4. Press the **Select** soft key to choose the **Alarm** menu. The display will show the current alarm time.
5. Press  or  to select **On/Off**.
6. Press the **Select** soft key.
7. If the alarm is activated, enter the alarm time in **HH:MM** format. Note that time must be entered in 24 hour format.
8. Press the **Next** soft key. A beep will sound and the display will show **Snooze On/Off**.
9. Press  or  to select enable or disable snooze. If snooze is enabled, the alarm will sound at 11 minute intervals.
11. Press the **Save** soft key to confirm and exit.

**Notes:** When the alarm sounds, press any key on the keypad to silence it.

To disable snooze, press  when the alarm sounds.







### **Audio Setup**

Use this option to adjust the volume of the receiver or speaker.

1. Press the **Menu** soft key.
2. Press  or  to select **HS Settings**.
3. Press the **Select** soft key.
4. Press  to choose the **Audio Setup** menu.
5. Press the **Select** soft key.
6. Press  or  to select **Speaker V** or **Earpiece V**.
7. Press the **Select** soft key. The display will show the current volume setting.
8. Press  or  to select the volume level (1 - 5).
9. Press the **Save** soft key to confirm and exit.

## Key Tone







Whenever a key is pressed, the 8012 acknowledges it with a key tone. If silent operation is desired, this feature may be disabled.

1. Press the **Menu** soft key.
2. Press  or  to select **HS Settings**.
3. Press the **Select** soft key.
4. Press the  or  to choose the **Tone Setup** menu.
5. Press the **Select** soft key.
6. Press the **Select** soft key again to select **Key Tone**.
9. Press  or  to enable or disable key tone.
10. Press the **Save** soft key to confirm and exit.

**Note:** Even if key tone is disabled, warning tones will continue to sound.







### LCD Contrast

The display contrast may be adjusted to provide better visibility.









1. Press the **Menu** soft key.
2. Press  or  to select **HS Settings**.
3. Press the **Select** soft key.
4. Press the  or  repeatedly to choose **LCD Contrast**.
5. Press the **Select** soft key.
6. Press the  or  repeatedly to choose the desired contrast level. Seventeen levels are available.
7. Press the **Save** soft key to confirm and exit.
8. Press  to return to standby mode.

### Base Selection

The handset may be registered to multiple bases.







1. Press the **Menu** soft key.
2. Press  or  to select **HS Settings**.
3. Press the **Select** soft key.
4. Press the  or  repeatedly to choose **Select Base** menu.
5. Press the **Select** soft key.
6. Press the  or  to choose the desired base.
7. Press the **Select** soft key to confirm. A warning tone will sound if the base does not exist. The display will show **Selected BSX**.
8. Press the **Select** soft key to confirm. A confirm tone will sound.

### **Date and Time Format**

1. Press the **Menu** soft key.
2. Press  or  to select **HS Settings**.
3. Press the **Select** soft key.
4. Press  or  to choose **Date & Time** menu.
5. Press the **Select** soft key.
6. Press  or  to choose **Date Format** or **Time Format**.
7. Press the **Select** soft key.
8. Press  or  to select the Date Format (**DD-MM/MM-DD**) or the Time Format (**12 Hour/24 Hour**).
9. Press the **Save** soft key to confirm and exit.







### Setting Date and Time

1. Press the **Menu** soft key.
2. Press  or  to select **HS Settings**.
3. Press the **Select** soft key.
4. Press  or  to choose **Date & Time** menu.
5. Press the **Select** soft key.
6. Press  or  to choose **Set Date** or **Set Time** menu.
7. Press the **Select** soft key.
8. Enter the current Time/Date with the keypad. Time must be entered in 24 hour format even if the display is set for 12 hour.
9. Press the **Save** soft key to confirm and exit.

## HS Reset

Resetting the handset will restore all handset features to their factory default values except LCD Contrast.





1. Press the **Menu** soft key.
2. Press  or  to select **HS Settings**.
3. Press the **Select** soft key.
4. Press  or  to choose the **HS Reset** menu.
5. Press the **Select** soft key. A prompt for the PIN will appear.
6. Enter the PIN Code. The default is 0000.
7. Press the **Reset** soft key. If the PIN is correct, all handset settings will be reset. If not, a warning tone will sound and all settings will remain the same.

**Note:** After resetting, the handset will return to standby mode.

## Registration

The handset ships from the factory registered as Number 1. Up to 5 handsets can be registered with one base. This allows a line to be shared among multiple handsets.



Before changing the handset registration, press the  key on the base for approximately 5 seconds. Then perform the following steps.

1. Press the **Menu** soft key.
2. Press  or  repeatedly to select **Registration**.
3. Press the **Select** soft key.
4. Press  or  to scroll through the Base Names.
5. Press the **Select** soft key to choose a base.
6. If the base is found, a prompt for the PIN Code will appear. The default PIN Code is 0000. Enter PIN Code and press the **Select** soft key. If the PIN Code is correct, a Registration tone will sound and the handset will be assigned a new number. If the PIN Code is incorrect, a warning tone will sound and the handset will return to its previous registration. If the base is not found, the handset will enter the Out of Range mode.

## Multiple Handset Operation

If more than one handset is registered to a base, internal calls can be made between handsets and external calls may be transferred between handsets.

### Internal Calling



1. Press . The display will show a list of available handsets.
2. Enter the number of the handset to be called.
3. If the handset number is valid, the called handset will ring and display **HSX Calling**.  
If the destination handset is not available, the calling handset will return to standby mode.
4. Press  to answer an internal call.
5. Press  to end the internal call.

**Note:** If an external call arrives during an internal call, the display will show the Caller ID information. To answer the external call, first press  to end the internal call.

Then, press  to answer the external call.





### **Call Transfer**

An external call may be transferred between handsets registered to the same base.

1. During an external call, press .
2. Enter the number of the handset to receive the transferred call.
3. Press  to answer a transferred call. Conversation may occur between the handsets.
4. To complete the transfer, press  at the transferring handset or replace it into the base.

### 3-Way Conference Call

A conference call may be established between two handsets and one external caller.

1. During an external call, press .
2. Enter the number of the handset to add to the conference call.
3. Press  to answer the call.
4. Press  at the calling handset to establish the conference.
5. Press  at either of the internal handsets to leave the call. Note that the other handset will remain connected to the call.

## **Maintenance Information**

Treat your telephone equipment with care for trouble-free performance. Avoid dropping the handset. Carefully place the handset in the base after use.

Avoid putting near heating appliances and devices that generate electrical noise (for example, motors and florescent lamps).

Clean your telephone equipment with a damp cloth. Stains may be removed with a mild soap. Do not use liquid or aerosol detergents or cleaning agents.

Do not expose to direct sunlight or moisture

Retain the original package in case you need to ship it at a later date.

## **Telephone Service Problems**

If you have any problems with your telephone service, determine if the problem is with your unit or the telephone company lines **BEFORE CALLING THE TELEPHONE COMPANY**. Be aware that the telephone company may charge you for a service call if the problem is caused by your telephone.

## Technical Specifications

Frequency Range	1.88 ~ 1.90 GHz
Channels	120 Duplex Channels
Carrier Power	< 250 mW
Modulation	GFSK
Frequency Stability	< ± 50 KHz
Charging Time	15 hours
Ambient Temperature	15 °C ~ 35 °C
Humidity	0% ~ 90%
Base Dimensions (mm)	Base: 110 X 100 X 58
Handset Dimensions (mm)	150 X 50 X 28
Base Power Supply	7.5V, 300 mA
Handset Power Supply	Ni-MH, 1.2V X 2, 600 mAh



## **Troubleshooting**

### **Phone Does Not Operate**

1. Power adapter is disconnected.
2. Line cord is disconnected at telephone outlet or at telephone. Test the telephone in a different wall jack. If it works, the first jack may be defective.
3. Batteries are discharged.
4. Batteries are improperly installed.

### **Blank Screen**

1. Batteries are discharged.
2. Batteries are improperly installed.
3. Handset is turned off.

### **Short Battery Life**

1. Base charging contacts are dirty or damaged.
2. Wrong type of batteries used.
3. Batteries may need to be replaced.

## **Troubleshooting (continued)**

### **Callers Are Not Displayed on Screen**

1. Verify that you have subscribed to the appropriate service (Caller ID and Call Waiting Caller ID) from your telephone company. If you only subscribed to Caller ID service the unit will not display call waiting caller ID information.
2. Check if your answering machine is set to answer before 2 rings.

### **No Caller Information is Displayed with the Call Waiting Beep**

1. Verify that you have subscribed to Call Waiting Caller ID service from your telephone company.

We encourage you to disconnect all the telephone cords and adapter; and then reinstall the unit step by step per this instruction manual before you ask for service.

### **Save These Instructions**

## **Telephone Repair**

DO NOT ATTEMPT TO REPAIR THIS PRODUCT YOURSELF. Telephones manufactured by CORTELCO must be returned to us for repair. You can return your telephone to CORTELCO for repair or replacement in accordance with our LIMITED WARRANTY.

CORTELCO warrants THIS PRODUCT against defects in material and workmanship in accordance with our LIMITED WARRANTY. If your telephone is returned for repair, include a copy of your sales receipt containing the date-of-purchase. DO NOT INCLUDE THE ORIGINAL SALES RECEIPT.

If date-of-purchase is not included, the factory date printed on the label on the bottom of your telephone will be used as the date-of-purchase. The factory date allows six months for distribution and sale of this product. If you return your telephone for repair, the warranty period is not extended. The original date-of-purchase continues to apply to your warranty.

OUT-OF-WARRANTY REPAIR We will repair this product for a nominal fee after the LIMITED WARRANTY has expired if you send it to us in a complete and undamaged condition. The repaired unit will be shipped to you C.O.D., freight collect.

**RETURN-FOR-REPAIR PACKAGING** If you are returning a unit to us for repair, package it carefully, preferably in the original carton. Be sure to include your return address, a copy of the sales receipt showing date-of-purchase, and a note describing the problem you have with your Telephone. Shipping must be prepaid. If the telephone is in warranty, it will be repaired or replaced, at our option, at no cost to you, and it will be returned shipping prepaid.

Ship your telephone (shipping prepaid) to:

CORTELCO  
REPAIR CENTER  
1703 SAWYER ROAD  
CORINTH, MS 38834

## FCC Information

**Part 68** is a Federal regulation which requires equipment to be tested and registered with the FCC prior to its connection to the network. This equipment complies with Part 68 of FCC rules. On the bottom of the telephone is a label that contains, among other information, the FCC Registration Number and the Ringer Equivalence Number (REN) for this equipment. You must, upon request, provide this information to your telephone company.

The **Ringer Equivalence Number**, which is used to determine the number of devices you may connect to your phone line, indicates the amount of power that your telephone draws from the telephone company line during ringing. If you have more than one telephone (or other terminal device) connected to the telephone company line, you should total the ringer equivalence numbers (REN s), and be sure that the total is not more than five. Your telephones may not ring if the total is more than five. Also, in some rural locations, your telephone may not ring if the REN total is more than three.

**RESTRICTIONS** You must not connect your telephone to coin-operated lines or party lines.

**INSTALLATION** This model telephone must be connected to the telephone company lines through a modular jack. The required USOC for the modular jack is RJ11C for desk mounting and RJ11W for wall mounting. The USOC number is printed on the label on the bottom of your telephone.

**HEARING-AID COMPATIBILITY** The handset on your telephone will work with magnetically-coupled hearing aids. You can use a hearing aid equipped with a T (Telephone) switch.

**IN CASE OF TROUBLE** If your telephone should cause problems on the telephone line, the telephone company can temporarily disconnect your service. The telephone company must then notify and allow you to correct the problem.

The telephone company may from time to time change its lines or equipment. They must notify you if planned changes will affect your telephone service, to allow you to take steps to prevent interruptions.

**Part 15** regulates the electromagnetic energy emitted by equipment to minimize interference to radio, television, and other wireless devices. This telephone complies with Part 15 of the FCC Rules. In the unlikely event that interference occurs, move the telephone and/or radio, television, etc. to increase the separation distance.

## LIMITED WARRANTY

If you purchased this product new in the U.S. or Puerto Rico, **CORTELCO** warrants it against defects in material and workmanship for a period of one (1) year from the date of original purchase. This warranty is in lieu of all other express warranties. During the warranty period, **CORTELCO** agrees to repair or, at its option, replace the defective product, or any part of it without charge for parts or labor. This is your exclusive remedy. This warranty does not cover damage resulting from accident, misuse, abuse, improper installation or operation, lack of reasonable care, the affixing of any attachment not provided by **CORTELCO** with the product and loss of parts. The warranty is voided in the event any unauthorized person alters or repairs the unit.

Telephone companies use different types of equipment and offer various types of services to customers. **CORTELCO does not warrant that this product is compatible with the type of equipment of any particular phone company or the services provided by it.**

**CORTELCO** DISCLAIMS ANY IMPLIED WARRANTY, INCLUDING THE WARRANTY OF MERCHANTABILITY AND THE WARRANTY OF FITNESS FOR A PARTICULAR PURPOSE, AS OF THE DATE ONE YEAR FROM THE ORIGINAL

PURCHASE OF THE PRODUCT. **CORTELCO** ASSUMES NO RESPONSIBILITY FOR ANY SPECIAL, INCIDENTAL OR CONSEQUENTIAL DAMAGES.

THIS WARRANTY GIVES YOU SPECIFIC LEGAL RIGHTS, AND YOU MAY HAVE OTHER RIGHTS WHICH VARY FROM STATE TO STATE. SOME STATES DO NOT ALLOW THE EXCLUSION OR LIMITATION OF SPECIAL, INCIDENTAL OR CONSEQUENTIAL DAMAGES OR LIMITATIONS ON HOW LONG AN IMPLIED WARRANTY LASTS, SO THE ABOVE EXCLUSION AND LIMITATION MAY NOT APPLY TO YOU.

If failure occurs and your telephone is in warranty, service shall be provided by returning it to **CORTELCO - Repair Center, 1703 Sawyer Road, Corinth, Mississippi 38834, shipping prepaid**. The product will be repaired or replaced if examination by us determines the product to be defective. Telephones received damaged as a result of shipping will require you to file a claim with the carrier.

Rev.1.0



## Free Manuals Download Website

<http://myh66.com>

<http://usermanuals.us>

<http://www.somanuals.com>

<http://www.4manuals.cc>

<http://www.manual-lib.com>

<http://www.404manual.com>

<http://www.luxmanual.com>

<http://aubethermostatmanual.com>

Golf course search by state

<http://golfingnear.com>

Email search by domain

<http://emailbydomain.com>

Auto manuals search

<http://auto.somanuals.com>

TV manuals search

<http://tv.somanuals.com>