

**IMPORTANT MANUAL**

**Do Not Throw Away**

**SEARS**

**Operator's  
Manual**

**Model No.**

**358.797922-32cc**

**358.797950-22cc**

**358.797961-22cc**

**358.797982-32cc**

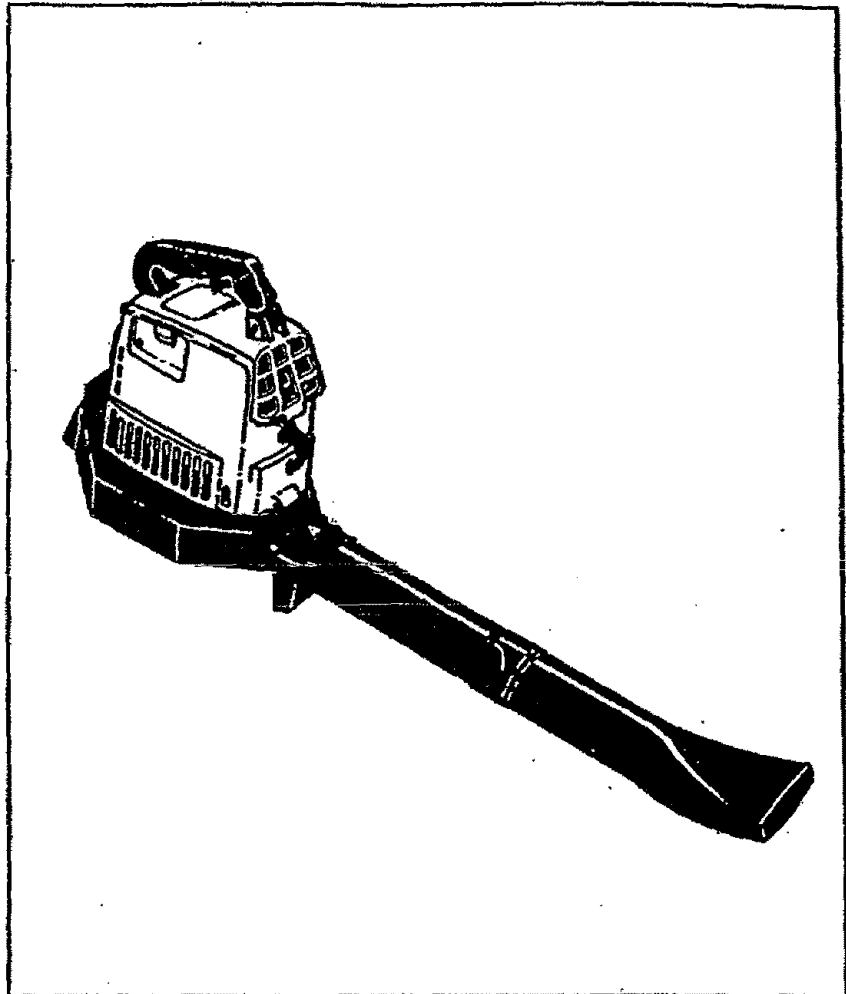

*Always Wear Eye Protection*

**SEARS/CRAFTSMAN®**

**GAS POWER BLOWER**

**▲ WARNING:**

**Read the Operator's Manual and Follow All ~~Warnings~~ and Safety Instructions. Failure To Do So Can Result in Serious Injury.**

**2 Cycle Engine**

• Assembly

• Operation

**Fuel Mix**

• Maintenance

• Repair Parts

Sold by Sears, Roebuck and Co., Chicago, IL 60684 USA

530-081829-1-06/17/93

© 1993 Sears, Roebuck and Co.

## LIMITED WARRANTY ON CRAFTSMAN POWER BLOWER

**WARRANTY PERIOD:** One Year - Models 358.797950 & 358.797961  
Two Years - Models 358.797922 & 358.797982

For the Warranty Period specified above from the date of purchase, when this Power Blower is maintained, lubricated, and tuned up according to the operating and maintenance instructions in the operator's manual, Sears will repair free of charge any defect in material or workmanship.

This warranty excludes blower tubes, spark plug, and air cleaner, which are expendable parts and become worn during normal use.

If this Power Blower is used for commercial or rental purposes, this warranty applies for 90 days.

**WARRANTY SERVICE IS AVAILABLE BY RETURNING THE UNIT TO THE NEAREST SEARS SERVICE CENTER DEPARTMENT IN THE UNITED STATES.** This warranty applies only while this product is in use in the United States.

This warranty gives you specific legal rights, and you may also have other rights which vary from state to state.

SEARS, ROEBUCK AND CO./DEPT. D/817WA, HOFFMAN ESTATES, IL 60179

## TABLE OF CONTENTS

<p><b>WARNINGS AND SAFETY INSTRUCTIONS</b> . . . 3</p> <p><b>KNOW YOUR UNIT</b> . . . . . 4</p> <p><b>ASSEMBLY</b> . . . . . 5</p> <p><b>USING YOUR UNIT</b> . . . . . 6</p> <p style="padding-left: 20px;">A. Operator Safety . . . . . 6</p> <p style="padding-left: 20px;">B. Operating Tips--Blower . . . . . 7</p> <p style="padding-left: 20px;">C. Operating Tips--Vacuum . . . . . 7</p> <p style="padding-left: 20px;">D. Pre-operation Checks . . . . . 7</p> <p><b>ENGINE INFORMATION</b> . . . . . 8</p> <p style="padding-left: 20px;">A. Fueling Your Engine . . . . . 8</p> <p style="padding-left: 20px;">B. Starting Instructions . . . . . 8</p> <p style="padding-left: 20px;">C. Carburetor Adjustments . . . . . 9</p>	<p><b>GENERAL MAINTENANCE</b> . . . . . 10</p> <p style="padding-left: 20px;">A. Air Filter . . . . . 10</p> <p style="padding-left: 20px;">B. Fuel Tank . . . . . 10</p> <p style="padding-left: 20px;">C. Starter Rope . . . . . 10</p> <p style="padding-left: 20px;">D. Storage . . . . . 12</p> <p style="padding-left: 20px;">E. Trouble Shooting Chart . . . . . 12</p> <p><b>ACCESSORIES</b> . . . . . 12</p> <p><b>REPAIR PARTS LIST</b> . . . . . 13</p> <p><b>QUICK REFERENCE PAGE</b> . . . . . 16</p> <p><b>PARTS AND SERVICE</b> . . . . . Back Cover</p>
---	---

## SPECIFICATIONS

<b>ENGINE TYPE:</b>	2 Cycle Air Cooled	<b>MUFFLER:</b>	Lo Tone
<b>DISPLACEMENT:</b>	22cc-- Model 358.797950 Model 358.797961 32cc-- Model 358.797922 Model 358.797982	<b>AIR VELOCITY:</b>	155 mph-- Model 358.797950 Model 358.797961 170 mph-- Model 358.797922 Model 358.797982
<b>ENGINE RPM:</b>	Operating--7000-7600-- All Models  Idle--3800-4600-- All Models	<b>AIR VOLUME:</b>	350 cu.ft./min.-- Model 358.797950 Model 358.797961 360 cu.ft./min.-- Model 358.797922 Model 358.797982
<b>IGNITION:</b>	Solid State	<b>SPARK PLUG:</b>	CJ-8Y(Cat. No. 71-85853)
<b>CARBURETOR:</b>	All Position Diaphragm	<b>SPARK PLUG GAP:</b>	.025"
<b>ON/OFF SWITCH:</b>	Positive Rocker Switch	<b>MODULE AIR GAP:</b>	.010"-.014"
<b>STARTER:</b>	Auto Rewind	<b>LUBRICATION:</b>	Gasoline/Oil Mixture-- See "Fueling Your Engine"
<b>FUEL TANK:</b>	18.6 fl. oz.		

Manufactured under one or more of the following U.S. Patents: 4,404,706; 4,413,371; 4,674,146; 4,940,028; RE 33,030; 4,798,185; 4,402,106; D299,074. Other U.S. and foreign patents pending

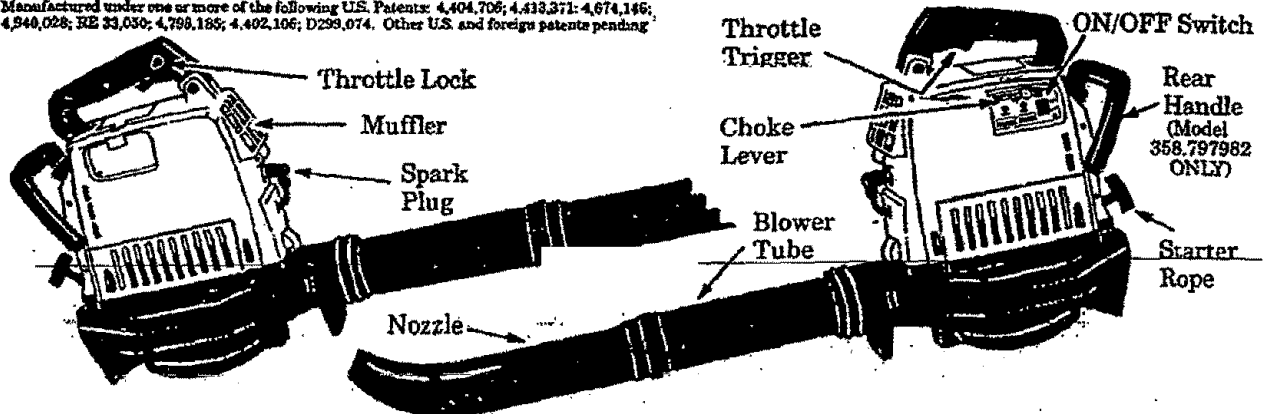

# **▲ WARNINGS AND SAFETY INSTRUCTIONS**

*Failure to follow all Safety Rules and Precautions can result in serious injury.*

## **A. KNOW YOUR UNIT**

1. Read your Operator's Manual carefully until you completely understand and can follow all warnings and safety instructions before operating unit.
2. Restrict your unit to users who understand and will follow all warnings and safety instructions in this manual.

## **B. PLAN AHEAD**

1. Always wear eye protection to prevent rocks or debris from being blown or ricocheting into eyes and face which can result in blindness and/or other serious injury.
2. Always wear a respirator or facemask when working with the unit in dusty environments.
3. Always wear heavy, long pants, boots, and gloves. Do not go barefoot or wear short pants, sandals, jewelry, loose clothing, or clothing with loosely hanging straps, ties, tassels, etc.; they can be caught in moving parts. Secure hair so it is above shoulder length. Being fully covered will help protect you from pieces of toxic plants such as poison ivy thrown by the blade, which could be more of a hazard than touching the plant itself.
4. Do not operate the unit when you are tired, ill, upset, or if you are under the influence of alcohol, drugs, or medication.
5. Keep children, bystanders, and animals away from the work area a minimum of 30 feet when starting or operating the unit.
6. Inspect the area before starting the unit. Remove all debris and hard objects such as rocks, glass, wire, etc. that can ricochet, be thrown, or otherwise cause injury or damage during operation.

## **C. HANDLE FUEL WITH CAUTION**

1. Eliminate all sources of sparks or flame (including smoking, open flames, or work that can cause sparks) in areas where fuel is mixed, poured, or stored.
2. Mix and pour fuel in an outdoor area; store fuel in a cool, dry, well-ventilated place; use an approved, marked container for all fuel purposes.
3. Do not smoke while handling fuel or while operating the unit.
4. Do not fill fuel tank while engine is running.
5. Stop the engine before removing the fuel cap. Allow the engine to cool before refueling.
6. Wipe up all fuel spills before starting engine.
7. Move at least 10 feet away from fuel and fueling site before starting the engine.

## **D. OPERATE YOUR UNIT SAFELY**

1. Stop the engine before opening the vacuum inlet door or attempting to insert or remove the vacuum tubes. The engine must be stopped and the impeller blades no longer turning to avoid serious injury from the rotating blades.
2. Inspect the entire unit before each use for worn, loose, missing, or damaged parts. Do not use until the unit is in proper working order.
3. Keep the outside surfaces free of oil and fuel.
4. Never start or run unit inside a closed room or building. Breathing exhaust fumes can kill.
5. To avoid shock from static electricity, do not wear rubber or any other insulated gloves while operating the unit.
6. Never use for spreading chemicals, fertilizers, or any other material which may contain toxic substances.
7. Do not set the unit on any surface except a clean, hard area to start the engine or while the engine is running. Debris such as gravel, sand, dust, grass, etc. could be picked up by the air intake and thrown out through the discharge opening, damaging the unit, property, or causing serious injury to bystanders or the operator.
8. Avoid dangerous environments. Do not use in unventilated areas or where explosive vapors or carbon monoxide build up could be present.
9. Avoid situations which could set the collection bag on fire. Do not vacuum discarded cigars or cigarettes or ash from fireplaces, barbecue pits, brush piles, etc. To avoid spreading fire, do not use blower near leaf or brush fires, fireplaces, barbecue pits, ashtrays, etc.
10. Do not overreach or use from unstable surfaces such as ladders, trees, steep slopes, rooftops, etc. Use extra care when cleaning on stairways. Keep firm footing and balance at all times.
11. Never place objects inside the blower tubes; always direct the blowing debris away from people, animals, glass, and solid objects such as trees, automobiles, walls, etc. The force of air can cause rocks, dirt, or sticks to be thrown or to ricochet which can hurt people or animals, break glass, or cause other damage. Do not allow the unit to be used as a toy.
12. Never place any object in the air intake opening as this could restrict proper air flow and cause damage to the unit.
13. Never run unit without the proper equipment attached. When used as a blower, always install a blower tube. When used as a vacuum, always install vacuum tubes and collection bag assembly.
14. Use only for jobs explained in this manual.

## **E. MAINTAIN YOUR UNIT PROPERLY**

1. Have all maintenance other than the recommended procedures described in the Operator's Manual performed by your Sears Service Center.
2. Disconnect spark plug before performing maintenance except for carburetor adjustment.
3. Use only genuine replacement parts as recommended by Sears to avoid creating a hazard and/or voiding your warranty.
4. Check air intake openings, blower tubes, elbow tube, and vacuum tubes frequently, always with the engine stopped. Keep vents and tubes free of debris which can accumulate and restrict proper air flow.
5. Before storing the unit, use up fuel left in the carburetor and fuel lines by starting the engine and letting it run until it stops. See "Storage" section.
6. Do not use any accessory or attachment other than those recommended by Sears for use with your unit.
7. Do not store the unit or fuel in a closed area where fuel vapors can reach sparks or an open flame from hot water heaters, electric motors or switches, furnaces, etc.
8. Store in a dry area out of reach of children.

*If situations occur which are not covered in this manual, use care and good judgement.  
Contact your Sears Service Center/Department if you need assistance.*

# KNOW YOUR UNIT

## A. INTRODUCTION

Your blower is a high performance product designed for tough jobs.

Special Features include:

- Top handle for one-handed operation.
- Direct Drive.
- Vibration-Dampened Handle.
- Weight - 12 lbs.
- Convenient upright storage.
- Available Gutter Attachment Kit #358.79992

## B. UNPACKING INSTRUCTIONS

1. Remove contents from the carton if you have not done so.
2. Check parts against the Carton Contents List.
3. Examine parts for damage. Do not use damaged parts.
4. Notify your Sears Service Center/Department immediately if a part is missing or damaged.

**NOTE:** It is normal to hear the fuel filter rattle in an empty fuel tank.

**NOTE:** Your unit is factory equipped with a vibration-dampened handle which causes the handle to appear to be loose. This condition is normal. See the Safety Notice at the bottom of this page.

**NOTE:** Your unit has been factory tested and the carburetor precisely adjusted. Therefore, it is possible to smell gasoline or to find a drop of oil/fuel residue on the muffler.

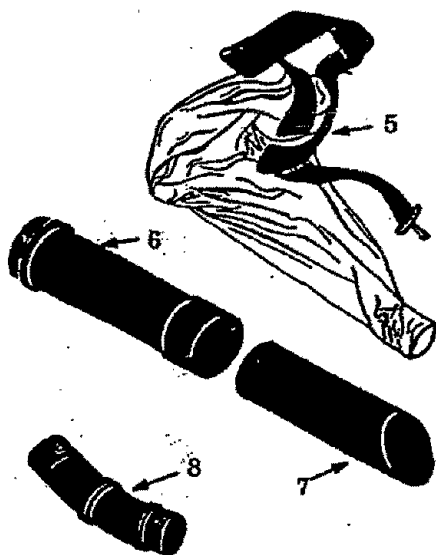

KEY NO.	CARTON CONTENTS	QTY.
1.	Powerhead	1
2.	Blower Tube	1
3.	Concentrator Nozzle	1
4.	Flare Nozzle	1
5.	Vacuum Collection Bag	1
6.	Upper Vacuum Tube	1
7.	Lower Vacuum Tube	1
8.	Elbow Tube	1
9.	2-cycle Engine Oil	1
-	Operator's Manual (not shown)	1

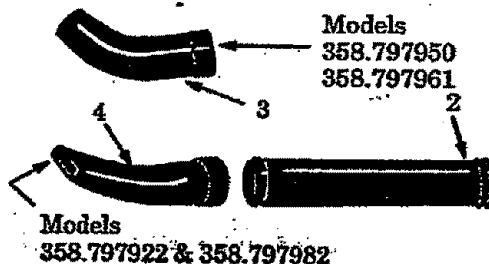
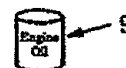

### SAFETY NOTICE

Exposure to vibrations through prolonged use of gasoline powered hand tools could cause blood vessel or nerve damage in the fingers, hands, and wrists of people prone to circulation disorders or abnormal swellings. Prolonged use in cold weather has been linked to blood vessel damage in otherwise healthy people. If symptoms occur such as numbness, pain, loss of strength, change in skin color or texture, or loss of feeling in the fingers, hands, or wrists, discontinue the use of this tool and seek medical attention. An anti-vibration system does not guarantee the avoidance of these problems. Users who operate power tools on a continual and regular basis must monitor closely their physical condition and the condition of this tool.

### SPECIAL NOTICE

For users on U.S. Forest Land and in some states, including California (Public Resources Codes 4442 and 4443), Idaho, Maine, Minnesota, New Jersey, Oregon, and Washington: Certain internal combustion engines operated on forest, brush, and/or grass-covered land in the above areas are required to be equipped with a spark arrestor, maintained in effective working order, or the engine must be constructed, equipped, and maintained for the prevention of fire. Check with your state or local authorities for regulations pertaining to these requirements. Failure to follow these requirements is a violation of the law. This unit is not factory-equipped with a spark arrestor; however, a spark arrestor is available as an optional part. If a spark arrestor is required in your area, contact your Sears Service Center or Parts Department for Spark Arrestor kit #530-069948. The spark arrestor, blower tubes, and nozzles must be assembled to the unit to be in full compliance with the regulations.

# ASSEMBLY

## A. PREPARATION

Your Operator's Manual has been developed to help you assemble the unit and to understand its safe operation. It is important that you read your manual completely to become familiar with the unit *before* you begin assembly.

1. READ YOUR OPERATOR'S MANUAL.
2. The only tool required is a standard screwdriver.

**NOTE:** To ease assembly, lubricate locking tabs before assembling tubes.

## B. BLOWER TUBE ASSEMBLY

1. Locate the two locking tabs on the side of the blower tube. Figure 1.
2. Align the grooves on the nozzle with the locking tabs on the blower tube and push the nozzle onto the blower tube.
3. Turn the nozzle clockwise until the parts snap into place and are firmly tightened.
4. Align Grooves on the Blower Tube with Locking Tabs in the Blower Outlet (Figure 1, inset) and push the Blower Tube into the Blower Outlet.
5. Turn the Blower Tube clockwise until the parts snap into place and are firmly tightened.

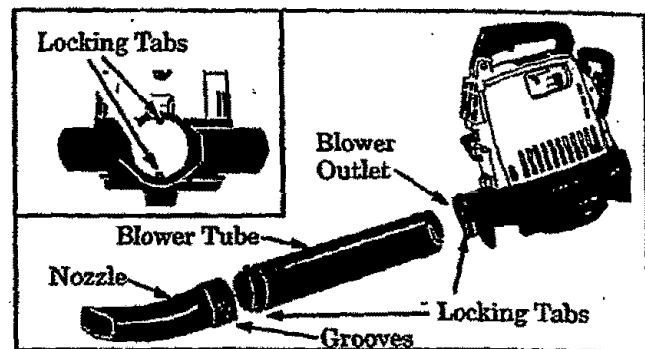

Figure 1

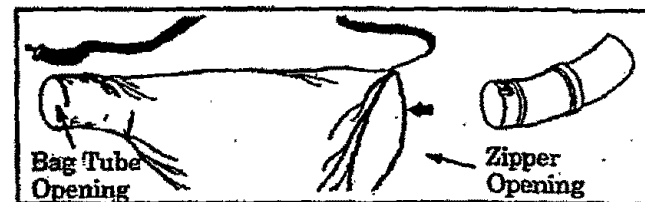

Figure 2

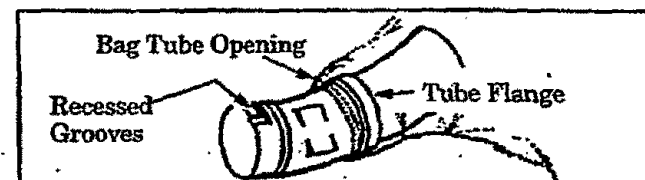

Figure 3

## C. VACUUM BAG ASSEMBLY

1. Open the zipper on the large end of the vacuum bag.
2. Insert the Elbow Tube, grooved end first, through the zipper opening in the vacuum bag (Figure 2). Then, push the grooved end of the Elbow Tube through the bag tube opening in the other end of the bag. Figures 2 & 3. Make sure the bag tube opening is flush against the tube flange. Figure 3.
3. Close the zipper on the bag. Make sure the zipper is closed completely and the zipper seam is tucked toward the inside of the bag. Figure 4 (inset).

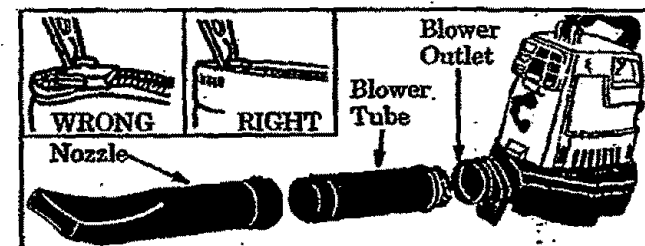

Figure 4

## D. VACUUM TUBE ASSEMBLY

**⚠ WARNING**  
Stop the engine before opening the vacuum inlet door or attempting to insert or remove the vacuum tubes. The engine must be stopped and the impeller blades no longer turning to avoid serious injury from the rotating blades.

1. Remove the blower tube from the engine. Figure 4.
2. Set the unit, blower outlet up, on a flat surface (Figure 5). Open the vacuum inlet cover as follows:
  - a. Insert a screwdriver into latch area. Figure 5.
  - b. Gently twist the tip of the screwdriver and open the vacuum inlet cover with your other hand.
3. Hold open vacuum inlet cover and align the grooves on the upper vacuum tube with the locking tabs inside the vacuum inlet. Figure 6. Insert the upper vacuum into the vacuum inlet; twist the upper vacuum tube clockwise until parts snap together.
4. Assemble the vacuum tubes by aligning the slanted end of the lower vacuum tube with the blower outlet as shown in Figure 6. Push the two tubes together until they are snug. Figure 6.

**NOTE:** The bottom end of the lower vacuum tube is cut at an angle. Make sure slanted end of vacuum tube is aligned with blower outlet. Figure 6.

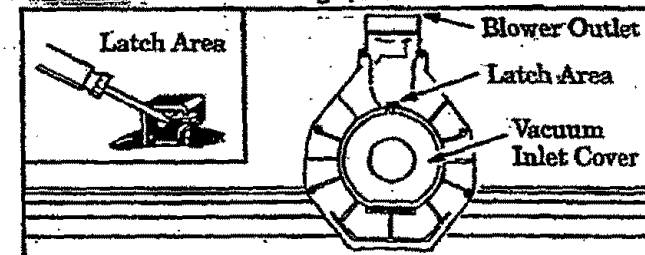

Figure 5

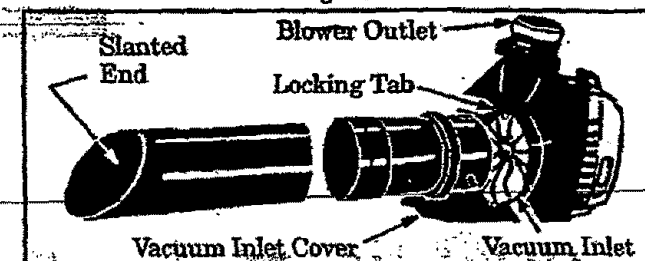

Figure 6

- To attach the vacuum bag, align the grooves on the elbow tube with the locking tabs inside the blower outlet. Figure 7 (inset). Be sure to align the dot on the elbow tube with the dot on the blower housing. Insert elbow tube into blower outlet; twist elbow tube counterclockwise until parts snap together.
- Adjust the vacuum collection bag at the elbow tube to remove any twists. Figure 8.

### E. SHOULDER STRAP ADJUSTMENT

- With your left hand hold the unit in an upright position, supporting the Lower Vacuum Tube on the ground. Figure 8. Make sure the Blower Outlet and Collection Bag are positioned on your right-hand side. Figure 8.
- Place collection bag strap around your back and over your left shoulder. Snap collection bag hook onto the strap retainer in the top handle. Figure 8.
- Extend your right arm toward the rear of the collection bag. Figure 8.
- Adjust the shoulder strap until the collection bag/shoulder strap seam lies between your thumb and index finger. Figure 8.
- Make sure the shoulder strap is adjusted to allow a free flow of air from the elbow tube. Figure 8. If the Bag is kinked, the unit will not operate properly.

### F. BLOWER CONVERSION

- Stop the engine. Allow the engine to cool.
- Remove the vacuum tubes and collection bag assembly.

- Secure the vacuum inlet cover. Make sure that the latch on the vacuum inlet cover is securely fastened.
- Reinstall the blower tubes as shown in the "Blower Tube Assembly" section.

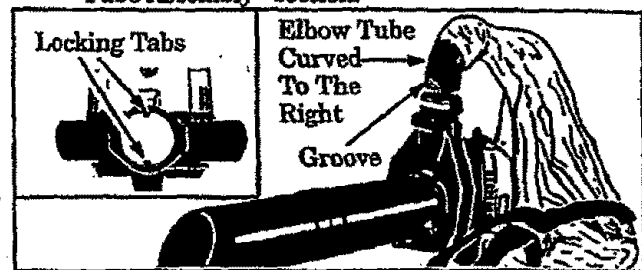

Figure 7



Figure 8

## USING YOUR UNIT

### A. OPERATOR SAFETY

#### ▲ WARNING

Do not assemble or disassemble the vacuum tube while the engine is running. Inserting or removing the vacuum tube while the engine is running can result in serious injury. Always stop the engine and disconnect the spark plug before unclogging the unit or performing any maintenance on the collection bag.

As a blower, the unit is designed to sweep debris, grass, straw, leaves, small twigs, or light snow. It can also be used for fast drying wet outdoor areas such as a patio, sidewalk, carport, etc. Never use for spreading or misting chemicals, fertilizers, or any other materials which may contain toxic substances. As a vacuum, the unit is designed to pick up dry material such as leaves, grass, small twigs, and bits of paper. Do not attempt to vacuum stones, gravel, metal, broken glass, or any other debris which may cause damage to the impeller. Do not attempt to vacuum water or any other liquids. Vacuuming water or other liquids will cause damage to the engine. Avoid situations that could catch the collection bag on fire. Do not operate near an open flame. Do not vacuum discarded cigars or cigarettes or ash from fireplaces, barbecue pits, brush piles, etc.

- Read your Operator's Manual. Make sure you completely understand and can follow all warnings and safety instructions in the manual before operating the unit.
- Always wear a respirator or facemask when working in dusty environments.
- Always wear eye protection to prevent rocks or debris from being blown or ricocheting into eyes and face which can result in blindness or other serious injury.

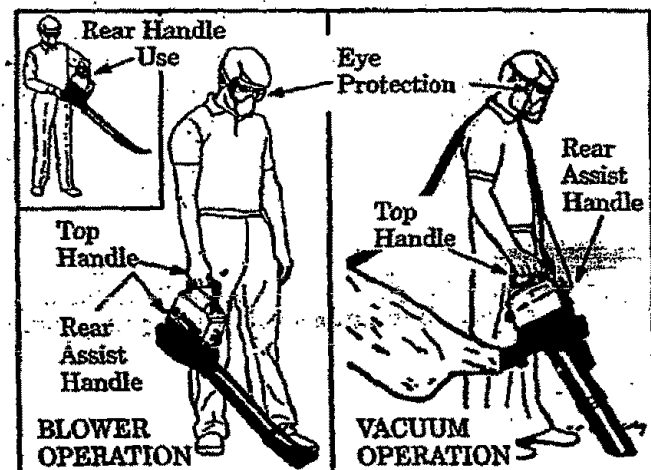

Figure 9

- Always wear heavy, long pants, boots, and gloves. Do not go barefoot or wear short pants, sandals, jewelry, loose clothing, or clothing with loosely hanging straps, ties, tassels, etc. Secure hair so it is above shoulder length. Being fully covered will help protect you from pieces of toxic plants such as poison ivy thrown by the blade, which could be more of a hazard than touching the plant itself.
- Check the unit before each operation. Look for worn, loose, missing, or damaged parts. Do not use the unit until it is in proper working order.
- Inspect area before starting engine. Remove all debris and objects such as rocks, glass, wire, large sticks, etc., that can cause damage during operation.

7. Keep children, bystanders, and animals safely away. Before starting the engine and during operation, make certain children, people, and animals are a minimum of 30 feet away from the work area.
8. Check air intake opening, blower tubes, vacuum tubes, and elbow tube frequently, always with engine stopped and spark plug disconnected. Keep vents and discharge tubes free of debris which can accumulate and restrict proper air flow.
9. Use the correct operating position. Figure 9. Do not overreach or use from unstable surfaces such as ladders, trees, steep slopes, roof tops, etc. Keep firm footing and balance at all times.
10. To avoid shock from static electricity, do not wear rubber gloves or any other insulated gloves while operating the unit.

11. Never place objects inside blower tubes; always direct blowing debris away from people, animals, glass, and solid objects such as trees, automobiles, walls, etc. The force of air can cause rocks, dirt, or sticks to be thrown or to ricochet which may hurt people or animals, break glass, etc.
12. Never run the unit without the proper equipment attached. When using your unit as a blower, always install blower tubes. When using your unit as a vacuum, always install vacuum tubes and collection bag assembly. Make sure collection bag assembly is completely zipped as shown in Figure 4.
13. When using the unit as a vacuum, always use the shoulder strap to avoid loss of control.

## B. OPERATING TIPS -- BLOWER

### ▲ WARNING

Do not use the unit as a blower without the blower tubes properly attached to avoid flying debris and/or impeller contact which can cause serious injury.

1. Always work going away from solid objects such as walls, trees, automobiles, and fences.
2. Clean corners by starting in corners and moving outward to straight areas to prevent an accumulation of debris which could fly into face.
3. Be careful when working near plants. The force of the air could damage tender plants.
4. Direct air flow by directing the nozzle down or to one side.
5. Vary the air flow by adjusting your grip on the throttle trigger.

### ▲ WARNING

Always wear eye protection to prevent rocks or debris from being blown or ricocheting into the eyes and face which can result in blindness or serious injury.

6. Use the assist handle located on the back of the unit when working above the waist or when a two-handed grip is desired.
7. Uses For Your Blower:
  - a. Sweeping debris or grass clippings from driveways, sidewalks, patios, parks, parking lots, barns, stadiums, etc.
  - b. Blowing grass clippings, straw, or leaves into piles.
  - c. Fast drying wet outdoor areas such as a patio.
  - d. Removing debris from corners, around joints, and between bricks.
  - e. Blowing light snow from driveways, sidewalks, or patios.

## C. OPERATING TIPS -- VACUUM

### ▲ WARNING

Do not use the unit as a vacuum without the vacuum tube and collection bag properly attached to avoid flying debris and/or impeller contact which can cause serious injury. Always make sure the collection bag is completely zipped before the engine is started.

1. When using your unit as a vacuum, best results are achieved when the unit is operated at full throttle. Engage the Throttle Lock before beginning vacuuming procedures.
2. Move the unit slowly back and forth over debris to be vacuumed. Avoid forcing the vacuum tube into a pile of debris as this can clog the unit.
3. The vacuum can pick up objects that are too big to pass through the impeller. This type of object will fall out of the vacuum tubes when the engine is stopped.

4. If the unit becomes clogged:
  - a. Stop the engine and disconnect the spark plug wire. Do not attempt to remove obstructions with the engine running.
  - b. Wait until the impeller has completely stopped turning, then remove the vacuum tube.
  - c. Carefully reach into the vacuum opening and clear out debris.
5. The collection bag must be properly emptied and maintained to avoid deterioration and obstruction of air flow which will reduce the performance of the vacuum.
  - a. Empty the bag after each use.
  - b. Remove the bag/elbow from the unit by turning it in a clockwise direction. Do not store bag containing leaves, grass, etc.
  - c. Wash the bag once a year as follows:
    - 1) Turn the bag inside out.
    - 2) Hang it up.
    - 3) Thoroughly hose it down.
    - 4) Let bag hang until dry.

## D. PRE-OPERATION CHECKS

Before operating your unit, always:

1. ✓CHECK OVER WARNINGS AND SAFETY INSTRUCTIONS in this Operator's Manual. Make certain you completely understand and follow each one.
2. ✓CHECK THE AIR FILTER. Clean the filter if dirty before operating the unit. For location, see the "Air Filter" section.

3. ✓CHECK THE UNIT FOR LOOSE BOLTS, NUTS, OR FITTINGS. Tighten, repair, or replace parts as necessary. You will need a Phillips screwdriver and a  $\frac{5}{32}$  hex wrench. Use only genuine replacement parts as recommended by Sears.
4. ✓CHECK THE FUEL TANK. Fill with a clean, fresh fuel mixture according to the instructions in the "Fuel Mixture" section.

# ENGINE INFORMATION

## A. FUELING YOUR ENGINE

### 1. FUEL SAFETY

- Use only recommended fuel mixtures.
- Mix and pour fuel outdoors and where there are no sparks or flames.
- Use a container approved for fuel.
- Do not smoke or allow smoking near fuel or the unit or while using the unit.
- Wipe up all fuel spills before starting the engine.
- Move at least 10 feet away from fueling site before starting engine.
- Stop engine before removing fuel cap. Allow the engine to cool before refueling.
- Before storing the unit, use up fuel left in fuel lines and carburetor by starting engine and letting engine run until it stops.
- Store unit and fuel in an area where fuel vapors cannot reach sparks or open flames from water heaters, electric motors or switches, furnaces, etc.

### 2. FUEL MIXTURE

- Your unit is powered by a 2-cycle engine which requires a fuel mixture of regular unleaded gasoline and a high quality engine oil specially made for 2-cycle, air cooled engines. The internal design of the 2-cycle engine requires lubrication of moving parts. Lubrication is provided when recommended mixture of gasoline and oil is used.
- Gasoline must be clean and fresh. After a short period of time, gasoline will chemically break down and form compounds that cause hard starting and damage in 2-cycle engines.
- The correct measure of gasoline to oil is very important. Too much oil in the mixture will foul the spark plug.

**CAUTION:** Too little oil will cause the engine to over heat and seize.

### 3. USE THE FOLLOWING ONLY:

WEED EATER 40:1, 2-cycle engine oil is strongly recommended. PARAMOUNT, POULAN, or POULAN PRO brand 40:1 2-cycle engine oil is acceptable if mixed according to the instructions on the container.

1 PART OIL TO 40 PARTS GASOLINE=

3.2 fl. oz. oil to 1 gallon gasoline

8.0 fl. oz. oil to 2.5 gallon gasoline

Not all air cooled 2-cycle engine oils have the same qualities. If WEED EATER, PARAMOUNT, POULAN, or POULAN PRO brand 2-cycle engine oil is not available, use a good quality, 2-cycle engine oil recommended for air-cooled engines. Mix at a ratio of 40:1 (3.2 oz. oil to 1 gallon gasoline). A 40:1 fuel mixture with these oils will assure adequate lubrication for your engine.

### 4. DO NOT USE:

- NMMA Oil**—National Marine Manufacturers Association (formerly BIA)—Does not have proper additives for 2-cycle, air cooled engines and can cause engine damage.
- AUTOMOTIVE OIL**—Does not have proper additives for 2-cycle, air cooled engines and can cause engine damage.

**▲ CAUTION**  
Experience indicates that alcohol blended fuels (called gasohol or using ethanol or methanol) can attract moisture which leads to separation and formation of acids during storage. Acidic gas can damage the fuel system of an engine while in storage. To avoid engine problems, do not leave fuel in the unit when storing for 30 days or longer. Start the engine and let it run until the fuel lines and carburetor are empty. Use fresh fuel next season. See the "Storage" section for additional information. Never use engine or carburetor cleaner products in the fuel tank or permanent damage can occur.

### 5. HOW TO MIX FUEL AND FILL TANK

- Pour the proper measure of engine oil into an approved, marked container. Then, fill the container with regular unleaded gasoline.  
**NOTE:** If fuel is already in the container, add the proper measure of engine oil. Then, close the container tightly and shake it momentarily.  
**NOTE:** Do not mix gasoline and oil directly in the fuel tank.
- Using a spout or funnel, fill the fuel tank with fuel mix.
- Reinstall the fuel caps securely.

## B. STARTING INSTRUCTIONS

### ▲ WARNING

When starting engine, hold the unit as shown in Figure 10. Do not set the unit on any surface except a clean, hard area while the engine is running. Debris such as gravel, sand, dust, grass, etc. could be picked up by the air intake and thrown out through the discharge opening, damaging the unit or property or causing serious injury to bystanders or operator.

### 1. Before Starting the Engine:

- Fuel the engine. Move at least 10 feet away from the fueling site.
- Hold the unit in the starting position as shown in Figure 10. When using the unit as a blower, make sure the blower end is directed away from people, animals, glass, and solid objects. When using the unit as a vacuum, make sure

the vacuum end is directed away from people, animals, glass, and solid objects.

### 2. For a Cold Engine or a Warm Engine After Running Out of Fuel.

- Move Ignition Switch to the "ON" position. Figure 11.
- Move Choke to "FULL". Figure 11.
- Engage the Throttle Lock as follows:
  - Fully squeeze and hold the throttle trigger.
  - Press and hold the throttle lock button. Figure 11 (inset).
  - Release the throttle trigger. Leave the throttle lock engaged thru step "g."
- Pull Starter Rope sharply until engine attempts to run, but no more than 8 pulls on full choke. The engine "attempts to run" may be hard to hear. The operator must listen carefully. After 8 pulls, proceed to step "e" even if the engine has not attempted to run.



- e. Move Choke to "HALF". Figure 11.
- f. Pull Starter Rope sharply until engine runs, but no more than 5 pulls.

**NOTE:** If engine has not started after 5 pulls, repeat steps "a" through "f."

- g. Allow engine to run for 5 seconds, then move Choke to "OFF" position. Release Throttle Lock by squeezing and releasing the Throttle Trigger. Figure 11.

**NOTE:** If engine dies with Choke at "OFF" position, repeat steps "e" through "g." If engine does not operate properly, refer to "Carburetor Adjustments."

- h. To stop engine, move ignition Switch to "OFF" position. Figure 11.

### 3. For a Warm Engine:

- a. Move the Ignition Switch to the "ON" position. Figure 11.
- b. Move Choke Lever to the "HALF" position. Figure 11.
- c. Engage Throttle Lock. Figure 11 (inset). Leave throttle lock engaged thru step "d."
- d. Pull Starter Rope sharply until engine runs, but no more than 5 pulls.
- e. Move Choke to "OFF". Figure 11.
- f. Release Throttle Lock by squeezing and releasing the Throttle Trigger. Figure 11.

**NOTE:** If engine does not run after 5 pulls, it is probably flooded. Wait a few minutes and repeat procedure with Choke at "OFF" position.

- g. To stop engine, move Ignition Switch to "OFF" position. Figure 11.

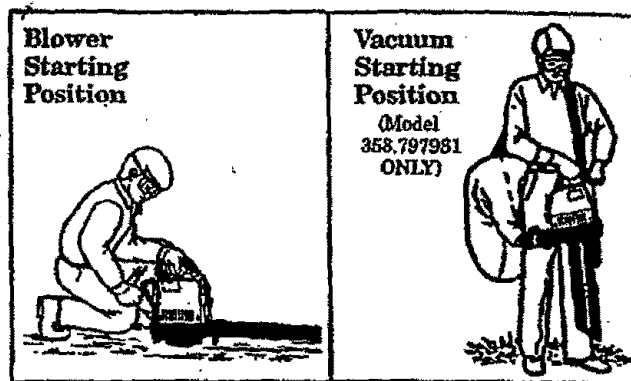

Figure 10

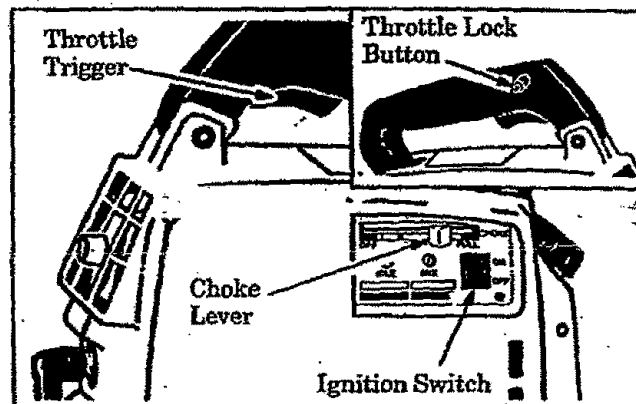

Figure 11

## C. CARBURETOR ADJUSTMENTS

- Poor engine performance can be a result of other causes such as dirty air filter, carbon build-up on muffler outlets, etc. See "Trouble Shooting Chart" before proceeding with carburetor adjustments.
- The carburetor has been carefully adjusted at the factory. Due to changes in altitude and operating conditions, your carburetor may require adjusting. To make the adjustment, carefully follow the procedure below.

### 1. PREPARATION

- a. Use fresh fuel mix. See the "Fueling Your Engine" section.
- b. Turn Mixture Screw (Figure 12) clockwise until fully closed, but do not overtighten. Figure 12. Turn mixture screw one full turn counterclockwise.
- c. Turn Idle Speed Screw (Figure 12) clockwise until it stops. Do NOT overtighten. Turn screw three full turns counterclockwise.

### 2. IDLE SPEED ADJUSTMENT

- a. Start the engine and run the unit for 10-15 minutes to warm up engine.
- b. Allow the engine to return to idle speed.
- c. Adjust Idle Speed Screw until the engine idles as slowly as possible without stalling.
  - Turn screw clockwise if engine stalls.
  - Turn screw counterclockwise to slow engine down.

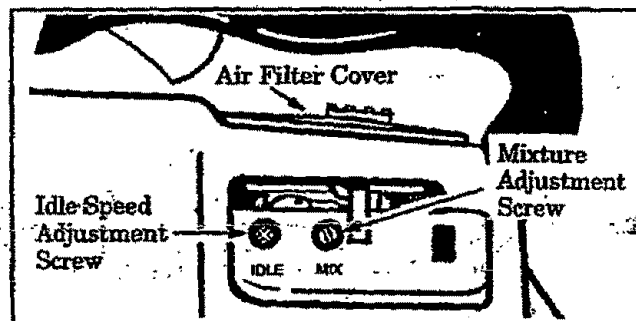

Figure 12

**CAUTION:** The mixture setting is a highly critical adjustment. If set incorrectly, permanent damage will occur to the engine. Do not operate engine at full throttle for prolonged periods while making the mixture adjustment. The final mixture screw setting should be in the range of 3/4 to 1-1/4 turns open.

### 3. MIXTURE ADJUSTMENT:

- a. Accelerate engine to full throttle.
- b. Turn the Mixture Screw slowly clockwise until the engine speed is reduced. Note position.
- c. Turn the screw slowly counterclockwise. Stop when the engine just begins to run roughly.
- d. Turn the screw slowly the minimum amount clockwise until the engine runs smoothly.

# GENERAL MAINTENANCE

## A. Air Filter

A dirty air filter decreases engine performance and increases fuel consumption.

**Clean the Air Filter:**

- Frequently,
- Always clean after 5 tanks of fuel or 5 hours of operation, whichever is less.

Follow these steps:

1. Move the choke lever to "Full". Figure 11.
2. Remove the air filter cover on top of the unit (under the handle). Figure 13.
3. Remove the air filter. Figure 13.
4. Wash the air filter with soap and water.

**CAUTION:** To avoid creating fire hazard, do not clean filter in gasoline or other flammable solvent.

5. Squeeze the air filter dry.
6. Add 4 or 5 drops of oil to the air filter.

**NOTE:** Avoid soaking the air filter with oil.

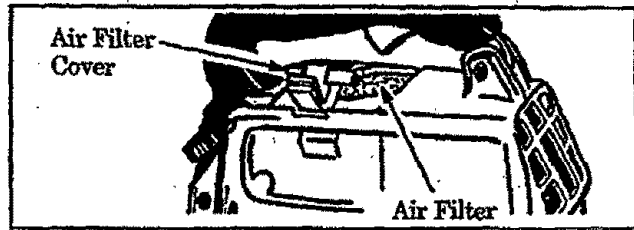

Figure 13

7. Squeeze the air filter to distribute oil.
8. Reassemble the air filter onto the cover.

**CAUTION:** The holes in the air filter must be fitted over the posts on the air filter cover. When installing the air filter/cover assembly, be sure that the filter does not hang on the choke lever screw.

9. Reassemble air filter/cover assembly to unit. Return choke lever to the "Off" position. Figure 11.

## B. FUEL TANK

1. Never use gasoline that is more than 2 months old in a fuel mixture. Gasoline begins to break down after a short period of time and will form compounds that cause hard starting and damage in 2-cycle engines.
2. Inspect the unit for fuel leaks each time it is used. Repair or replace parts as necessary.

3. Using a fuel mix or gasoline over 2 months old will cause the engine to be difficult or impossible to start.
4. Empty the fuel tank before storing the unit. Use up fuel left in the carburetor by starting the engine and letting it run until it stops.

## C. STARTER ROPE

Replace the starter rope if the rope breaks or is badly worn.

**NOTE:** When replacing an unbroken rope, cut the rope and allow the rope to rewind onto the pulley.

### ▲ WARNING

Do not remove the Pulley when replacing the starter rope. Always wear eye protection when servicing the starter rope. The recoil spring, located beneath the pulley, is under tension. If the spring pops out, serious injury can result.

To repair or replace:

1. Disconnect spark plug wire from the spark plug.
2. Set unit, blower outlet up, on a flat surface. Figure 14. Open the vacuum inlet cover as follows:
  - a. Insert a screwdriver into the latch opening. Figure 14(inset).
  - b. Gently twist the screwdriver while opening the vacuum inlet cover with your other hand.
3. Remove the impeller nut and washers while holding the impeller. Figure 14.
4. Remove the 4 impeller shroud screws. Figure 15. Then, remove the 2 engine shroud screws located by the spark plug. Figure 15. Remove the impeller shroud from the engine shroud.
5. Remove the 5 screws from the pulley housing, then remove the pulley housing and pulley from the engine. Figure 16.
6. Remove the rope retainer screw from pulley; then, remove the broken piece of rope, if any. Figure 17.
7. Grasp the pulley ratchet and wind the pulley clockwise until the pulley stops. Then, slowly unwind the pulley counterclockwise until the pulley notch is aligned with the pulley housing notch. Figure 17. Insert the hex wrench into the hole formed by the aligned notches. Figure 17.

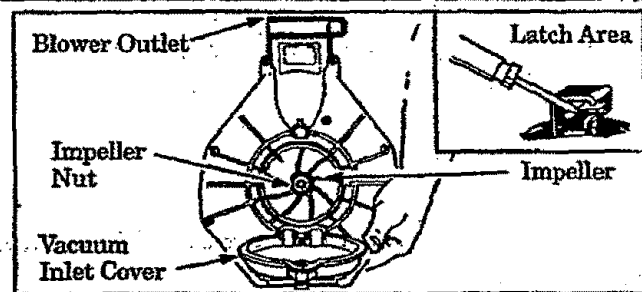

Figure 14

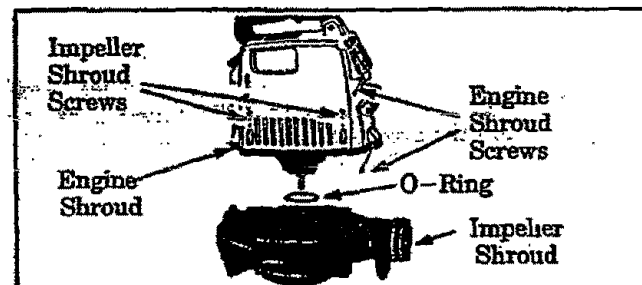

Figure 15

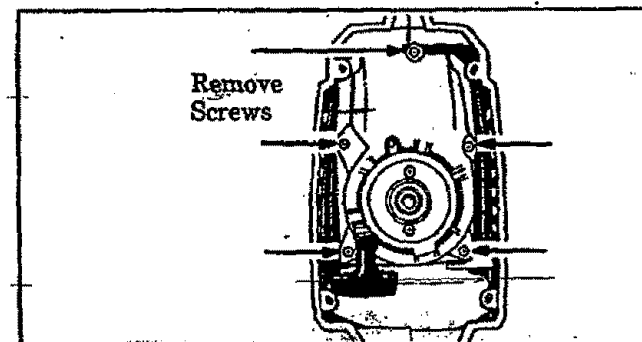

Figure 16

8. Move away from the fuel tank and melt the ends of the rope.
9. Allow each melted end to drip once; then while the rope is still hot, pull each melted end through a clean rag to obtain a smooth, pointed end.
10. Insert one end of the rope through the handle and secure with a knot. Leave 3/16" pigtail behind the knot. Figure 18 (Inset).
11. Insert the other end of the rope through the metal grommet, then under the Rope Guide. Figure 18.
12. Guide rope inside the pulley, then through Pulley Hole. Figure 17.
13. Wrap rope counterclockwise around the pulley ratchet and tuck the loose end back under the rope, leaving about a 1 inch tail next to the Retainer Rib. Figure 19.
14. Install and tighten the Retainer Screw/Washer. Figure 17.

**NOTE:** Do not overtighten the Retainer Screw. Over tightening the screw can cause the screw post to strip out. Tighten the screw until the bottom of the washer either (1) is snug against the rope or (2) contacts the top of the screw post.

15. Pull the rope tightly around the pulley ratchet.
16. Slightly pull the rope to relieve the pressure on the hex wrench. Remove the hex wrench and allow the rope to rewind slowly.
17. Reassemble the Pulley Housing to the engine. Tighten screws securely.

**NOTE:** Be sure the rubber O-Ring is installed onto the pulley housing. See Figure 15.

18. Align the hole in the impeller with the impeller shaft, making sure the flat sides are aligned. Figure 20.

**NOTE:** When reassembling the Impeller Housing to the Engine Shroud, be sure not to overtighten screws. Overtightening the screws can strip out the Impeller Housing.

19. Assemble parts by reversing steps 1. through 4.

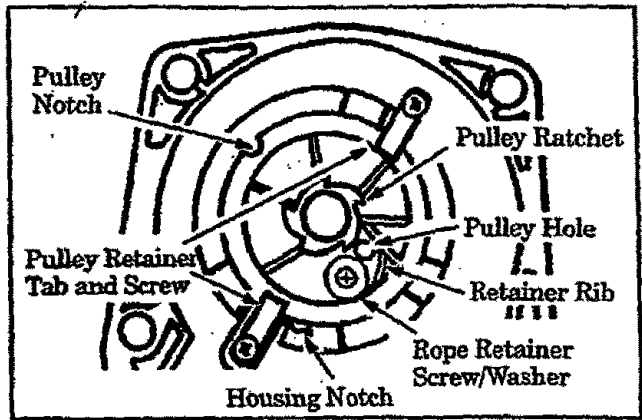

Figure 17

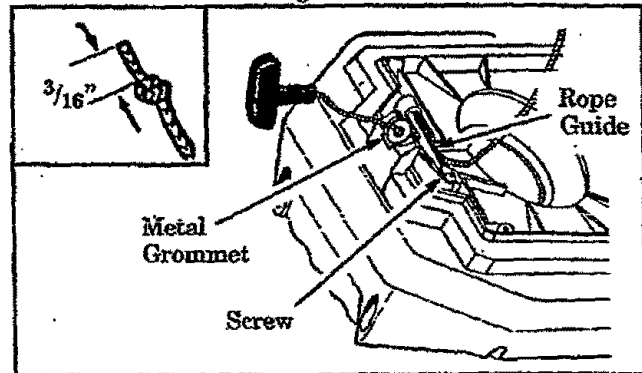

Figure 18

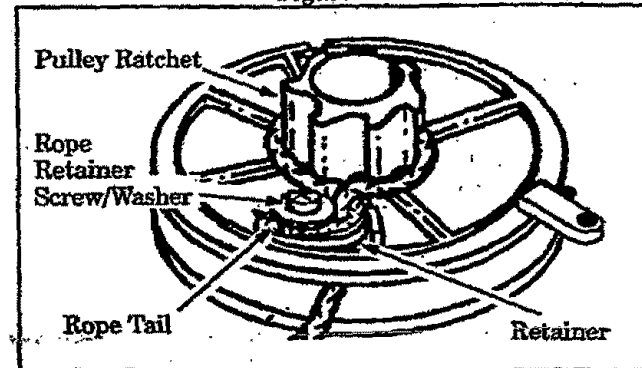

Figure 19

Rib

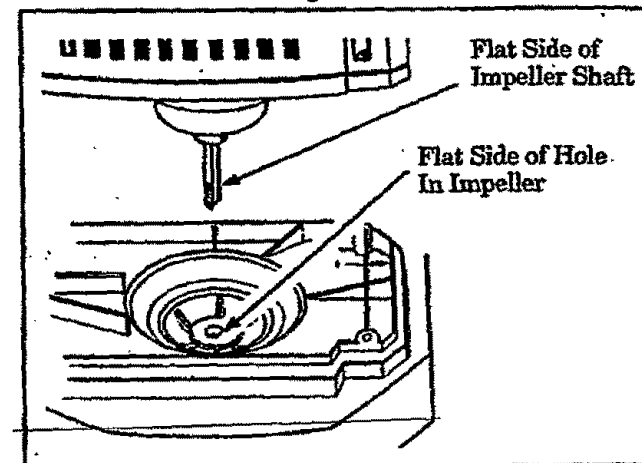

Figure 20

## D. STORAGE

1. Clean the unit before storing. Pay particular attention to the air intake area, keeping it free of debris. Use a mild detergent and sponge to clean the plastic surfaces.
2. Do not store the unit or fuel in a closed area where fuel vapors can reach sparks or an open flame from hot water heaters, electric motors or switches, furnaces, etc.
3. Store in a dry area out of the reach of children.

**NOTE:** If you do not want to remove the gasoline from your unit, SEARS CRAFTSMAN Fuel Stabilizer (#71-33500) may be added to gasoline left in the tank to minimize gum deposits and acids. If the tank is almost empty, mix stabilizer with fresh gasoline in a separate container and add to the tank.

ALWAYS FOLLOW INSTRUCTIONS ON THE STABILIZER CONTAINER. THEN, RUN THE ENGINE AT LEAST 10 MINUTES AFTER STABILIZER IS ADDED TO ALLOW MIXTURE TO REACH CARBURETOR. STORE UNIT IN A SAFE PLACE. SEE STEP 2 (this section).

### ▲ WARNING

It is important to prevent gum deposits from forming in essential fuel system parts such as the carburetor, fuel filter, fuel hose or fuel tank during storage. Experience indicates that alcohol blended fuels (called Gasohol or using ethanol or methanol) can attract moisture which leads to separation and formation of acids during storage. Acidic gas can damage the fuel system of an engine while in storage.

## E. TROUBLE SHOOTING CHART

TROUBLE	CAUSE	REMEDY
Engine will not start.	<ol style="list-style-type: none"> <li>1. Ignition switch off.</li> <li>2. Fuel tank empty.</li> <li>3. Spark plug not firing.</li> <li>4. Fuel not reaching carburetor</li> <li>5. Engine flooded.</li> <li>6. Compression low.</li> </ol>	<ol style="list-style-type: none"> <li>1. Move Ignition switch to "ON."</li> <li>2. Fill tank with correct fuel mixture.</li> <li>3. Install new spark plug.</li> <li>4. Check for dirty fuel filter; clean. Check for kinked or split fuel line; repair or replace.</li> <li>5. See "Starting Instructions."</li> <li>6. Contact your Service Center.</li> </ol>
Engine will not idle properly.	<ol style="list-style-type: none"> <li>1. Idle speed set too low.</li> <li>2. Idle speed set too high.</li> <li>3. Mixture screw requires adjustment.</li> <li>4. Crankshaft seals worn.</li> <li>5. Compression low.</li> </ol>	<ol style="list-style-type: none"> <li>1. Adjust idle speed screw clockwise to increase speed.</li> <li>2. Adjust idle speed screw counterclockwise to reduce speed.</li> <li>3. See "Carburetor Adjustments."</li> <li>4. Contact your Service Center.</li> <li>5. Contact your Service Center.</li> </ol>
Engine will not accelerate, lacks power, or dies under a load.	<ol style="list-style-type: none"> <li>1. Carburetor requires adjustment.</li> <li>2. Air filter dirty.</li> <li>3. Spark plug fouled.</li> <li>4. Carbon build-up.</li> <li>5. Compression low.</li> </ol>	<ol style="list-style-type: none"> <li>1. See "Carburetor Adjustments."</li> <li>2. Clean or replace air filter.</li> <li>3. Clean or replace spark plug and regap.</li> <li>4. Contact your Service Center.</li> <li>5. Contact your Service Center.</li> </ol>
Engine smokes excessively.	<ol style="list-style-type: none"> <li>1. Choke partially on.</li> <li>2. Air filter dirty.</li> <li>3. Mixture screw requires adjustment.</li> <li>4. Fuel mixture incorrect.</li> </ol>	<ol style="list-style-type: none"> <li>1. Adjust choke.</li> <li>2. Clean or replace air filter.</li> <li>3. See "Carburetor Adjustments."</li> <li>4. Empty fuel tank and refill with correct fuel mixture.</li> </ol>
Engine runs hot.	<ol style="list-style-type: none"> <li>1. Fuel mixture incorrect.</li> <li>2. Spark plug incorrect.</li> <li>3. Carbon build-up.</li> <li>4. Mixture screw set too low.</li> </ol>	<ol style="list-style-type: none"> <li>1. See "Fueling Your Unit."</li> <li>2. Replace with correct spark plug.</li> <li>3. Contact your Service Center.</li> <li>4. See "Carburetor Adjustments."</li> </ol>

## ACCESSORIES

The following accessories are available through Sears Retail Stores, Catalog Outlets, or Service Centers.

ITEM	STOCK NO.
Safety Goggles .....	71-85707
2-Cycle Engine Oil .....	71-36551
Spark Plug .....	71-85853
Gutter Attachment Kit .....	71-79992
Vacuum Attachment Kit .....	71-79994
Spark Arrestor .....	530-069348*
Operator's Manual .....	530-068243*

\* Available through your SEARS Service Center/Catalogue.

# SEARS GAS BLOWER REPAIR PARTS LIST - MODELS 358.797922, 358.797960, 358.797982

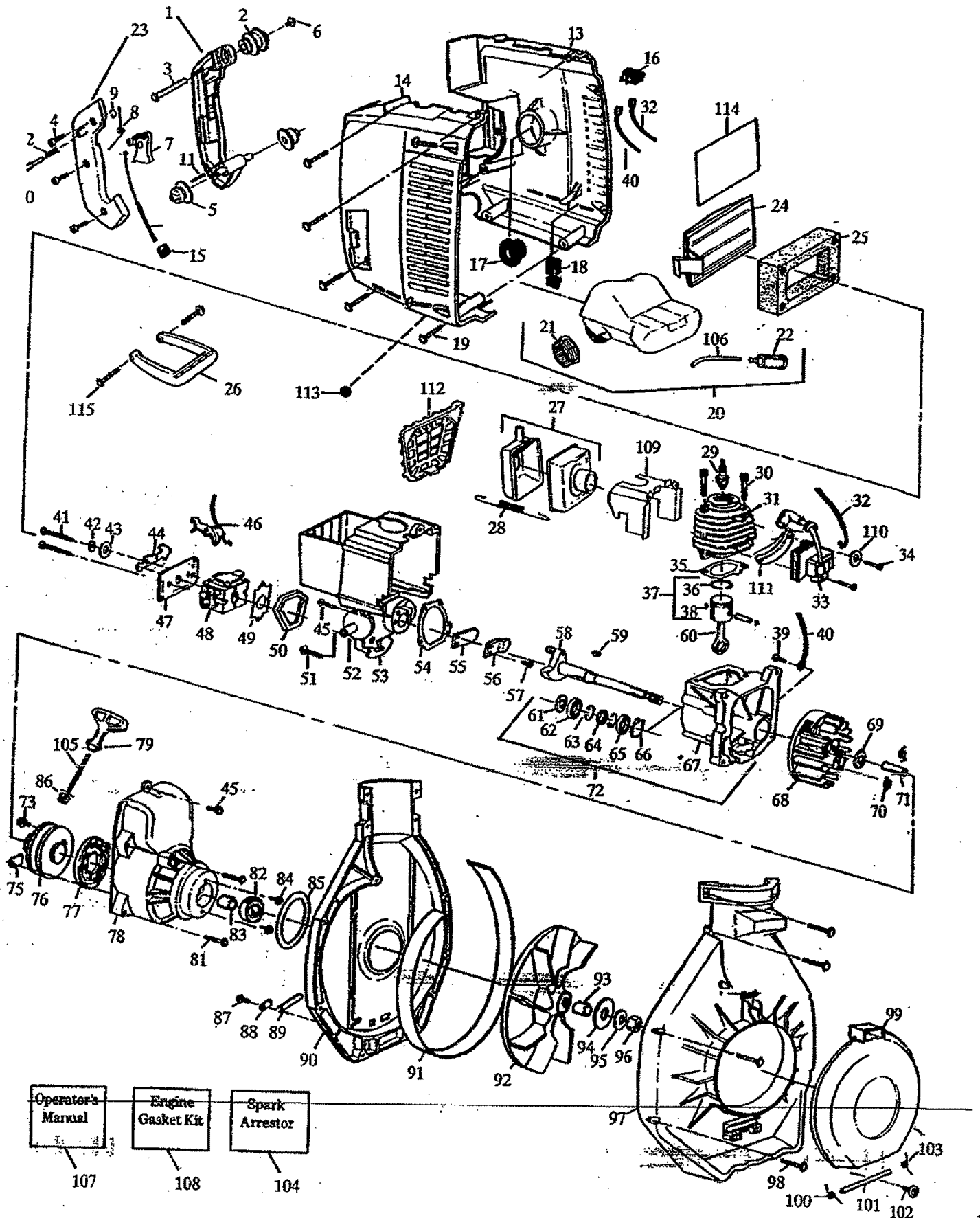

SEARS GAS BLOWER REPAIR PARTS LIST - MODELS 358.797922, 358.797960, 358.797982

Key No.	Part No.	Description	Key No.	Part No.	Description
1	530-094712	Handle	57	530-015241	Screw
2	530-026994	Front Isolator	58	530-014033	Crankshaft Ass'y.
3	530-029111	Spacer	59	530-015126	Key
4	530-015635	Screw	60	-	Piston Rod
5	530-029130	Rear Isolator		530-014005	Model No. 358.797960
6	530-015813	Screw		530-010969	Model Nos. 358.797922 & 358.797982
7	530-029072	Trigger			
8	530-027597	Spring	61	530-015788	Spacer
9	530-015702	"C" Clip	62	530-032103	Inner Bearing
10	530-029117	Throttle Lock Button	63	530-015787	Ring
11	530-015840	Pin	64	530-019158	Crankshaft Seal -
12	530-024772	Spring	65	530-032102	Outer Bearing
13	530-029068	Shroud - Left (Model 358.797960)	66	530-015789	Retaining Ring
	530-029610	Shroud - Left (Model 358.797922 & 358.797982)	67	530-014016	Crankcase
14	530-029067	Shroud - Right (Model 358.797960)	68	530-039136	Flywheel
	530-029609	Shroud - Right (Model 358.797922 & 358.797982)	69	530-347987	Washer
15	530-019168	Grommet	70	530-023817	Spring
16	530-069292	Switch	71	530-029176	Spacer
17	530-029129	Isolator	72	530-014156	Crankcase/Crankshaft Assy.
18	530-029089	Isolator	73	530-015823	Screw
19	530-015814	Screw	74	530-015496	Screw
20	530-014121	Fuel Tank Ass'y. (Incl. #21, 22 & 106)	75	530-027523	Retainer
21	530-010729	Fuel Cap (Incl. O'Ring)	76	530-069486	Starter Pulley (Incl. 73)
22	530-010897	Fuel Pick-up Ass'y.	77	530-029395	Starter Spring
23	530-014160	Handle Cover Ass'y. (Incl. 9, 10 & 12)	78	530-069563	Fan Housing Kit (Incl. Starter Pulley)
24	530-029071	Cover	79	530-027569	Starter Handle
25	530-029112	Air Filter	81	530-015769	Screw
26	530-094740	Assist Handle (Model 358.797982 Only)	82	530-032108	Bearing
27	530-069293	Muffler	83	530-029110	Spacer
28	530-029116	Spring	84	530-015805	Screw
29	530-030073	Spark Plug	85	530-019187	"O" Ring
30	530-015239	Screw	86	530-029182	Eyelet
31	-	Cylinder	87	530-015805	Screw
	530-012244	Model No. 358.797960	88	530-027523	Retainer
	530-012235	Model No. 358.797922 & 358.797982	89	530-029119	Roll Pin
32	530-029145	Lead Wire	90	530-094710	Blower Housing (Upper)
33	530-039137	Ignition Module	91	530-029173	Band
34	-	Screw	92	530-014157	Impeller
	530-015776	Model 358.797960	93	530-029118	Hub
	530-015816	Model 358.797922 & 358.797982	94	530-015818	Washer
35	530-019178	Gasket	95	530-015441	Washer
36	-	Piston Ring	96	530-015472	Nut
	530-026418	Model No. 358.797960	97	530-094711	Blower Housing (Lower) (Incl. 99-103)
	530-025875	Model Nos. 358.797922 & 358.797982	98	530-015367	Screw
37	-	Piston Kit (Incl. #36, 38, & Pin)	99	530-094715	Door
	530-069274	Model No. 358.797960	100	530-015667	Spring
	530-069349	Model Nos. 358.797922 & 358.797982	101	530-015647	Pin
			102	530-015815	Screw
			103	530-015672	Spring
			104	530-069348	Spark Arrestor Kit
			105	530-069232	Rope Kit
38	530-015162	Retainer	106	530-069247	Line Kit
39	530-015306	Screw	107	530-068243	Operators Manual
40	530-029144	Ground Wire	108	530-069294	Gasket Kit
41	530-015849	Screw	109	530-029404	Air Baffle
42	530-015254	Wave Washer	110	530-015811	Washer
43	530-027528	Spacer	111	530-027525	Spacer 358.797960 Only
44	530-029114	Choke Shutter	112	530-069303	Muffler Guard
45	530-015771	Screw	113	530-029460	Cap 358.797922 & 358.797960 Only
46	530-029146	Cable Assembly (Incl. #45)	114	-	Detail Instruction
47	530-029115	Plate		530-036274	Model No. 358.797922 & 358.797982
48	530-035263	Carburetor		530-029179	Model No. 358.797960
49	530-019164	Gasket	115	530-015843	Screw
50	530-019165	Seal			
51	530-015775	Screw			
52	530-029113	Ground Wire			
53	530-029070	Reed Block			
54	530-019166	Gasket			
55	530-027593	Reed Valve			
56	530-027594	Reed Stop			
				530-061350	Carton (Model 358.797922)
				530-061189	Carton (Model 358.797960)
				530-061347	Carton (Model 358.797982)

SEARS GAS BLOWER REPAIR PARTS LIST - MODELS 358.797922, 358.797960, 358.797982

**Carburetor Assembly Part Number 530-035262 WA-207/207A**

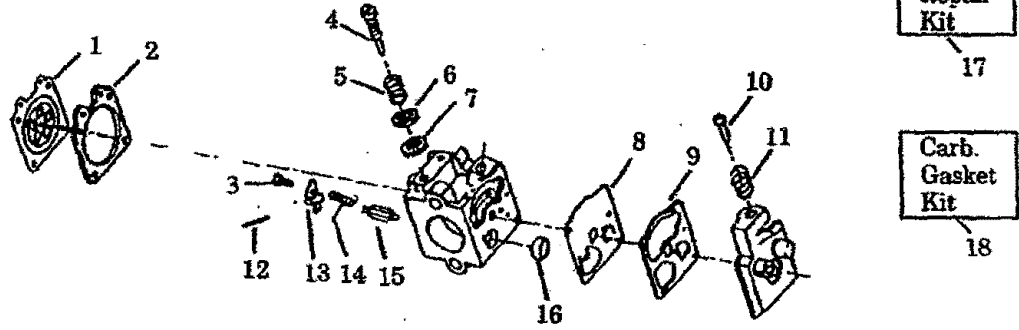

Key No.	Part No.	Description	Key No.	Part No.	Description
1	530-035014	*+ Metering Diaphragm	10	530-035203	Idle Speed Screw
2	530-035151	*+ Metering Diaphragm Gasket	11	530-035208	*+ Idle Speed Spring
3	530-035016	Metering Lever Pin Screw	12	530-035028	*+ Metering Lever Pin
4	530-035268	Mixture Needle	13	530-035031	Metering Lever
5	530-035214	Mixture Needle Spring	14	530-035188	Metering Lever Spring
6	530-035217	Mixture Needle Washer	15	530-035106	* Inlet Needle Valve
7	530-035218	"O" Ring Mixture	16	530-035178	* Fuel Inlet Screen
8	530-035166	Fuel Pump Diaphragm	17	530-035260	Carb. Kwik Repair Kit
9	530-035164	Fuel Pump Gasket	18	530-035219	Carb. Gasket/Diaphragm Kit (+ Indicates Contents)

**Vacuum Tube/Blower Tube Ass'y.**

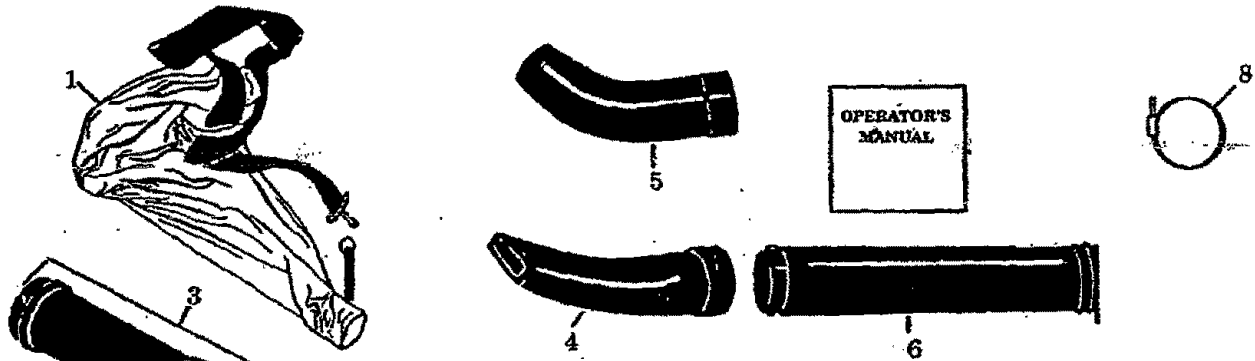

KEY NO.	PART NO.	DESCRIPTION
1	530-069272	Collection Bag W/Strap
2	530-094764	Collection Bag Elbow Tube
3	530-069270	Vacuum Tube
4	530-094662	Blower Nozzle--Flare
5	530-351455	Blower Nozzle--Concentrator
6	530-094664	Blower Tube
7	530-010850	Handle
8	530-094230	Clamp
9	530-067306	Operator's Manual
10	530-094740	Assist Handle
11	530-015814	Screw

# QUICK REFERENCE PAGE

Read and follow all Warnings and Safety Instructions.  
Failure to do so can result in serious injury.

	PAGE
<b>A. WARNINGS AND SAFETY INSTRUCTIONS .....</b>	<b>3</b>
1. Wear eye protection.	
2. Dress safely -- boots or safety shoes and long pants.	
3. Check for worn, loose, missing, or damaged parts and repair.	
4. Keep children, bystanders, and animals a minimum of 30 feet away.	
<b>B. FUELING YOUR ENGINE .....</b>	<b>8</b>
1. Eliminate all sources of sparks or flame where fuel is mixed, poured, or stored.	
2. Use clean, fresh gasoline.	
3. Use 3.2 oz. 2-cycle engine oil to 1 gal. gasoline OR 8 oz. oil to 2.5 gal. gasoline.	
4. Mix fuel in an approved, marked container; mix and pour fuel in an outdoor area.	
5. Move a minimum of 10 feet away from fuel and fueling site before starting engine.	
<b>C. STARTING INSTRUCTIONS .....</b>	<b>8</b>
1. Move the ignition switch to the "ON" position.	
2. Adjust the choke properly.	
3. Grasp the handle and squeeze the throttle trigger fully; engage the throttle lock.	
4. Make sure the nozzle is directed away from people, animals, glass, and solid objects.	
5. Pull the starter rope no more than 8 times to avoid flooding the engine.	
6. Stop the engine by moving the ignition switch to the "OFF" position.	
<b>D. GENERAL MAINTENANCE .....</b>	<b>10</b>
1. Have all maintenance other than the recommended procedures described in the Operator's Manual performed by your Sears Service Center.	
2. Disconnect the spark plug before performing maintenance except for carburetor adjustments.	
3. Run fuel from the unit before storing.	
4. Clean air filter frequently, but always after 5 hours of operation or 5 tanks of fuel, whichever is less.	
5. Store in a dry place out of the reach of children.	



# SEARS

## Operator's Manual

### Model No.

358.797922-32cc  
358.797950-22cc  
358.797961-22cc  
358.797982-32cc

### How to Order Repair Parts

**SEARS SERVICE  
IS AT YOUR SERVICE**

The Model Number will be found below the top handle with the Serial Number. Always mention the Model Number when requesting service or repair parts for your unit.

All parts listed herein may be ordered from any Sears Service Center and most Sears Stores.

**WHEN ORDERING REPAIR PARTS ALWAYS GIVE THE FOLLOWING INFORMATION AS SHOWN IN THIS LIST:**

- |                     |                         |
|---------------------|-------------------------|
| 1. The PART NUMBER  | 3. The PART DESCRIPTION |
| 2. The MODEL NUMBER | 4. The NAME OF ITEM --  |
| 358.797922-32cc     | GAS POWER BLOWER        |
| 358.797950-22cc     |                         |
| 358.797961-22cc     |                         |
| 358.797982-32cc     |                         |

If the parts you need are not stocked locally, your order will be transmitted to a Sears Repair Parts Distribution Center for handling.

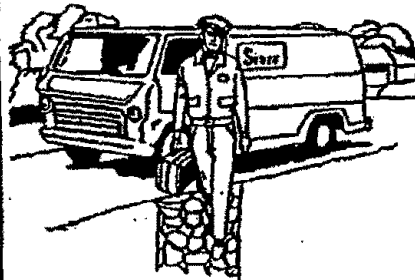

When you buy merchandise from Sears you get an extra value that nobody else can offer -- Sears Service.

Across town or across the country, Sears Service is always near, providing trustworthy, competent service technicians using only Sears specified factory parts.

Your Sears Merchandise takes on added value when you discover that Sears has Service Units throughout the country. Each is staffed by Sears-trained, professional technicians using Sears approved methods.

Sold by Sears, Roebuck and Co., Chicago, IL 60684 USA

530-081829-1-06/17/93

PRINTED IN U.S.A.

## Free Manuals Download Website

<http://myh66.com>

<http://usermanuals.us>

<http://www.somanuals.com>

<http://www.4manuals.cc>

<http://www.manual-lib.com>

<http://www.404manual.com>

<http://www.luxmanual.com>

<http://aubethermostatmanual.com>

Golf course search by state

<http://golfingnear.com>

Email search by domain

<http://emailbydomain.com>

Auto manuals search

<http://auto.somanuals.com>

TV manuals search

<http://tv.somanuals.com>