

Owner's Manual

CRAFTSMAN®

ROTARY POWER TOOLS

Model No. 572.611200



Caution:

Before using this product, read this manual and follow all its Safety Rules and Operating Instructions.

- Safety
- Operation
- Maintenance
- Parts
- Español, p. 23

Sears, Roebuck and Co., Hoffman Estates, IL 60179

2610925488 10/04

Table of Contents	Page
Warranty	2
Power Tool Safety Rules	3-5
Symbols	6
Functional Description and Specifications	7
Assembly	8-9
Operating Instructions	9-10
Speed Settings	11-13
Maintenance	14-15
Accessories	16-18
Attachments	19-22
Service Parts	23
Español	24-48

**FULL ONE YEAR WARRANTY
ON CRAFTSMAN ROTARY POWER TOOL**

If this Craftsman Rotary Power Tool fails to give complete satisfaction within one year from the date of purchase, **RETURN IT TO THE NEAREST SEARS STORE IN THE UNITED STATES**, and Sears will repair it, free of charge.

If this Craftsman Rotary Power Tool is used for commercial or rental purposes, this warranty applies for only 90 days from the date of purchase.

This warranty gives you specific legal rights, and you may also have other rights which vary from state to state.

Sears, Roebuck and Co., Dept. 817 WA, Hoffman Estates, IL 60179

POWER TOOL SAFETY RULES



WARNING

Read and understand all instructions. Failure to follow all instructions listed below, may result in electric shock, fire and/or serious personal injury.

SAVE THESE INSTRUCTIONS

WORK AREA

Keep your work area clean and well lit. Cluttered benches and dark areas invite accidents.

Do not operate power tools in explosive atmospheres, such as in the presence of flammable liquids, gases, or dust. Power tools create sparks which may ignite the dust or fumes.

Keep bystanders, children, and visitors away while operating a power tool. Distractions can cause you to lose control.

Electrical Safety

Double Insulated tools are equipped with a polarized plug (one blade is wider than the other.) This plug will fit in a polarized outlet only one way. If the plug does not fit fully in the outlet, reverse the plug. If it still does not fit, contact a qualified electrician to install a polarized outlet. Do not change the plug in any way. Double Insulation eliminates the need for the three wire grounded power cord and grounded power supply system. Before plugging in the tool, be certain the outlet voltage supplied is within the voltage marked on the nameplate. Do not use "AC only" rated tools with a DC power supply.

Avoid body contact with grounded surfaces such as pipes, radiators, ranges and refrigerators. There is an increased risk of electric shock if your body is grounded. If operating the power tool in damp locations is unavoidable, a Ground Fault Circuit Interrupter must be used to supply the power to your tool. Electrician's rubber gloves and footwear will further enhance your personal safety.

Don't expose power tools to rain or wet conditions. Water entering a power tool will increase the risk of electric shock.

Do not abuse the cord. Never use the cord to carry the tools or pull the plug from an outlet. Keep cord away from heat, oil, sharp edges or moving parts. Replace damaged cords immediately. Damaged cords increase the risk of electric shock.

When operating a power tool outside, use an outdoor extension cord marked "W-A" or "W." These cords are rated for outdoor use and reduce the risk of electric shock.

Personal Safety

Stay alert, watch what you are doing and use common sense when operating a power tool. Do not use tool while tired or under the influence of drugs, alcohol, or medication. A moment of inattention while operating power tools may result in serious personal injury.

Dress properly. Do not wear loose clothing or jewelry. Contain long hair. Keep your hair, clothing, and gloves away from moving parts. Loose clothes, jewelry, or long hair can be caught in moving parts. Keep handles dry, clean and free from oil and grease.

Avoid accidental starting. Be sure switch is "OFF" before plugging in. Carrying tools with your finger on the switch or plugging in tools that have the switch "ON" invites accidents.

Remove adjusting keys or wrenches before turning the tool ON. A wrench or a key that is left attached to a rotating part of the tool may result in personal injury.

Do not overreach. Keep proper footing and balance at all times. Proper footing and balance enables better control of the tool in unexpected situations.

Use safety equipment. Always wear eye protection. Dust mask, non-skid safety shoes, hard hat, or hearing protection must be used for appropriate conditions.

Tool Use and Care

Use clamps or other practical way to secure and support the workpiece to a stable platform. Holding the work by hand or against your body is unstable and may lead to loss of control.

Do not force tool. Use the correct tool for your application. The correct tool will do the job better and safer at the rate for which it is designed.

Do not use tool if switch does not turn it ON or OFF. Any tool that cannot be controlled with the switch is dangerous and must be repaired.

Disconnect the plug from the power source before making any adjustments, changing accessories, or storing the tool. Such preventive safety measures reduce the

risk of starting the tool accidentally.

Store idle tools out of reach of children and other untrained persons. Tools are dangerous in the hands of untrained users.

Maintain tools with care. Keep cutting tools sharp and clean. Properly maintained tools, with sharp cutting edges are less likely to bind and are easier to control. Any alteration or modification is a misuse and may result in a dangerous condition.

Check for misalignment or binding of moving parts, breakage of parts, and any other condition that may affect the tools operation. If damaged, have the tool serviced before using. Many accidents are caused by poorly maintained tools. Develop a periodic maintenance schedule for your tool.

Use only accessories that are recommended by the manufacturer for

your model. Accessories that may be suitable for one tool, may become hazardous when used on another tool.

Service

Tool service must be performed only by qualified repair personnel. Service or maintenance performed by unqualified personnel could result in a risk of injury. For example: internal wires may be misplaced or pinched, safety guard return springs may be improperly mounted.

When servicing a tool, use only identical replacement parts. Follow instructions in the Maintenance section of this manual. Use of unauthorized parts or failure to follow Maintenance Instructions may create a risk of electric shock or injury. Certain cleaning agents such as gasoline, carbon tetrachloride, ammonia, etc. may damage plastic parts.

SAFETY RULES FOR ROTARY TOOLS

Accessories must be rated for at least the speed recommended on the tool warning label. Wheels and other accessories running over rated speed can fly apart and cause injury.

Hold tool by insulated gripping surfaces when performing an operation where the cutting tool may contact hidden wiring or its own cord. Contact with a "live" wire will make exposed metal parts of the tool "live" and shock the operator. If cutting into existing walls or other blind areas where electrical wiring may exist is unavoidable, disconnect all fuses or circuit breakers feeding this worksite.

Do not operate the flexible shaft with a sharp bend. Over bending the shaft can generate excessive heat on the jacket or hand piece. The recommended minimum is 6" radius.

Always disconnect the power cord from the power source before making any adjustments or attaching any accessories. You may unexpectedly cause the tool to start leading to serious personal injury.

Be aware of the switch location, when placing the tool down or when picking the tool up. You may accidentally activate the switch.

Always hold the hand piece firmly in your hands during the start-up. The reaction torque of the motor, as it accelerates to full speed, can cause the shaft to twist.

Always wear safety goggles and dust

mask. Use only in well ventilated area. Using personal safety devices and working in safe environment reduces risk of injury.

After changing the bits or making any adjustments, make sure the collet nut and any other adjustment devices are securely tightened. Loose adjustment device can unexpectedly shift, causing loss of control, loose rotating components will be violently thrown.

Do not reach in the area of the spinning bit. The proximity of the spinning bit to your hand may not always be obvious.

Allow brushes to run at operating speed for at least one minute before using wheel. During this time no one is to stand in front or in line with the brush. Loose bristles or wires will be discharged during the run-in time.

Wire and bristle brushes must never be operated at speeds greater than 15,000/min. Direct the discharge of the spinning wire brush away from you. Small particles and tiny wire fragments may be discharged at high velocity during the "cleaning" action with these brushes and may become imbedded in your skin. Bristles or wires will be discharged from the brush at high speeds.

Carefully handle both the tool and individual grinding wheels to avoid chipping or cracking. Install a new wheel if tool is dropped while grinding. Do not use a wheel that may be damaged.

Fragments from a wheel that bursts during operation will fly away at great velocity possibly striking you or bystanders.

Never use dull or damaged bits. Sharp bits must be handled with care. Damaged bits can snap during use. Dull bits require more force to push the tool, possibly causing the bit to break.

Use clamps to support workpiece whenever practical. Never hold a small workpiece in one hand and the tool in the other hand while in use. Allow for sufficient space, at least 6", between your hand and the spinning bit. Round material such as dowel rods, pipes or tubing have a tendency to roll while being cut, and may cause the bit to "bite" or jump toward you. Clamping a small workpiece allows you to use both hands to control the tool.

Inspect your workpiece before cutting. When cutting irregularly shaped workpieces, plan your work so it will not slip and pinch the bit and be torn from your hand. For example, if carving wood, make sure there are no nails or foreign objects in the workpiece. Nails or foreign objects can cause the bit to jump.

Never start the tool when the bit is engaged in the material. The bit cutting edge may grab the material causing loss of control of the cutter.

Avoid bouncing and snagging the wheel, especially when working corners, sharp edges etc. This can cause loss of control and kick-back.

The direction of feed with the bit into the material when carving, routing or cutting is very important. Always feed the bit into the material in the same direction as the cutting edge is exiting from the material (which is the same direction as the chips are thrown). Feeding the tool in the wrong direction, causes the cutting edge of the bit to climb out of the work and pull the tool in the direction of this feed.

If the workpiece or bit becomes jammed or bogged down, turn the tool "OFF" by the switch. Wait for all moving parts to stop and unplug the tool, then work to free the jammed material. If the switch to the tool is left "ON" the tool could restart unexpectedly causing serious personal injury.

Do not leave a running tool unattended, turn power off. Only when tool comes to a complete stop it is safe to put it down.

Do not grind or sand near flammable materials. Sparks from the wheel could ignite these materials.

Do not touch the bit or collet after use. After use the bit and collet are too hot to be touched by bare hands.

Regularly clean the tool's air vents with compressed air. Excessive accumulation of powdered metal inside the motor housing may cause electrical failures.

Do not allow familiarity gained from frequent use of your rotary tool to become commonplace. Always remember that a careless fraction of a second is sufficient to inflict severe injury.

Do not alter or misuse tool. Any alteration or modification is a misuse and may result in serious personal injury.

This product is not intended for use as a dental drill, in human or veterinary medical applications. Serious injury may result.

When using the steel saws, cutoff wheels, high speed cutters or tungsten carbide cutters, always have the work securely clamped. Never attempt to hold the work with one hand while using any of these accessories. The reason is that these wheels will grab if they become slightly canted in the groove, and can kickback causing loss of control resulting in serious injury. Your second hand should be used to steady and guide the hand holding the tool. When a cutoff wheel grabs, the wheel itself usually breaks. When the steel saw, high speed cutters or tungsten carbide cutter grab, it may jump from the groove and you could lose control of the tool.

⚠ WARNING Some dust created by power drilling and other construction activities, contains chemicals known to cause cancer, birth defects or other reproductive harm. Some examples of these chemicals are:





- Lead from lead-based paints,
- Crystalline silica from bricks and cement and other masonry products, and
- Arsenic and chromium from chemically treated lumber.

Your risk from these exposures varies, depending on how often you do this type of work. To reduce your exposure to these chemicals, work in a well ventilated area, and work with approved safety equipment, such as those dust masks that are specially designed to filter out microscopic particles.

Use only accessories that are sold by Sears for your model. Accessories that may be suitable for one tool may become hazardous when used on another tool.

SYMBOLS

IMPORTANT! Some of the following symbols may be used on your tool. Please study them and learn their meaning. Proper interpretation of these symbols will allow you to operate the tool better and safer.

Symbol	Name	Designation/Explanation
V	Volts	Voltage (potential)
A	Amperes	Current
Hz	Hertz	Frequency (cycles per second)
W	Watt	Power
kg	Kilograms	Weight
min	Minutes	Time
s	Seconds	Time
\varnothing	Diameter	Size of drill bits, grinding wheels, etc.
n₀	No load speed	Rotational speed, at no load
.../min per minute	Revolutions or reciprocation orbits etc. per minute	Revolutions, strokes, surface speed,
0	Off position	Zero speed, zero torque...
1, 2, 3, ... I, II, III,	Selector settings	Speed, torque or position settings. Higher number means greater speed
	Infinitely variable selector with off	Speed is increasing from 0 setting
→	Arrow	Action in the direction of arrow
\sim	Alternating current	Type or a characteristic of current
==	Direct current	Type or a characteristic of current
	Alternating or direct current	Type or a characteristic of current
	Class II construction	Designates Double Insulated Construction tools.
\oplus	Earthing terminal	Grounding terminal
	Warning symbol	Alerts user to warning messages
	Ni-Cad RBRC seal	Designates Ni-Cad battery recycling program



This symbol designates that this tool is listed by Underwriters Laboratories.



This symbol designates that this tool is listed to Canadian Standards by Underwriters Laboratories.



This symbol designates that this tool complies to NOM Mexican Standards.



This symbol designates that this tool is listed by the Canadian Standards Association, and is listed to US Standards by CSA.



This symbol designates that this tool is listed by Underwriters Laboratories, and listed to Canadian Standards by Underwriters Laboratories.



This symbol designates that this tool is listed by the Canadian Standards Association.

FUNCTIONAL DESCRIPTION AND SPECIFICATIONS

Unpacking & Checking Contents

⚠ WARNING To avoid injury from unexpected starting or electrical shock, always remove plug from wall outlet when tool is not in use.

Separate all loose parts from packing materials and check each item with the contents listed on the carton to make sure all items are accounted for before discarding any packing material.

Description

The Rotary Tool incorporates both high-speed and performance to serve as a carver, grinder, polisher, sander, cutter, power brush, drill, and more.

The tool utilizes a small, but effective DC

motor. The large variety of available accessories includes abrasive wheels, drill bits, wire and nylon brushes, engraving and carving cutters, router bits, polishing points and more. The ability to add different attachments adds to the multi-faceted uses of the tool. The variety of projects you can do with the tool is limitless.

The Rotary Tool is a high-speed tool and operates at speeds 5,000 to 35,000 RPM. (A typical electric drill operates only up to 2500 RPM!). When used with accessories and attachments, the rotary tool's high speed performance allows you to work on even the most demanding projects without having to exert undue pressure on the tool. The tool does the work for you.

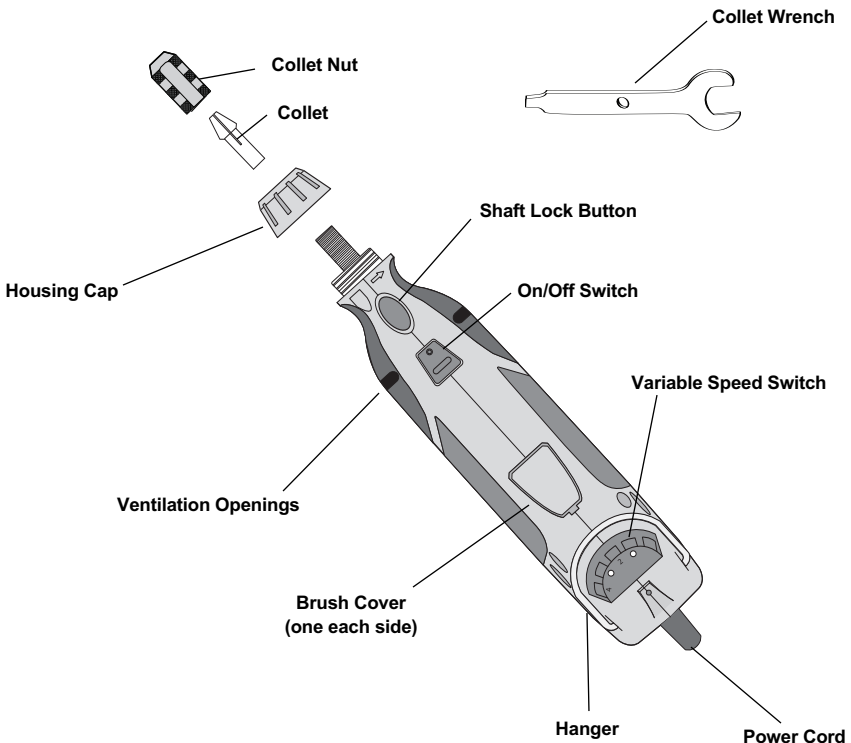

NOTE:! For tool specifications, refer to the nameplate on your tool.

ASSEMBLY

⚠ WARNING Always unplug rotary tool before changing accessories, changing collets, or servicing the tool.

Collets

The Craftsman accessories available for the rotary tool come with various shank sizes.

Four size collets are available to accommodate the different shank sizes. Collet sizes are identified by the rings on the back of the collet:

- 1/32" collet has 1 ring (No. 483)
- 1/16" collet has 2 rings (No. 482)
- 3/32" collet has 3 rings (No. 481)
- 1/8" collet has no rings (No. 480)

NOTE: Some rotary tool kits may not include all four collet sizes. Collets are available separately.

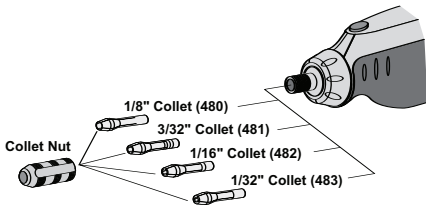

⚠ CAUTION Always use the collet which matches the shank size of the accessory you plan to use. Do not force a larger diameter shank into a smaller collet.

Changing Collets

1. Press the shaft lock button, hold down and rotate the shaft by hand until it engages the shaft.

⚠ WARNING Do not engage the shaft lock button while rotary tool is running.

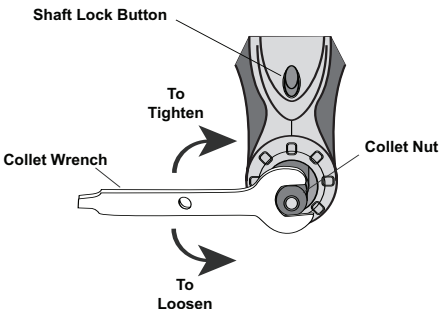

2. With the shaft lock button engaged, loosen and remove the collet nut. Use the collet wrench if necessary.
3. Remove the collet by pulling it free from the shaft.
4. Install the appropriate size collet fully into the shaft and reinstall the collet nut finger tight. Do not fully tighten the nut when there is no bit or accessory installed.

Changing Accessories

1. Press the shaft lock button and rotate the shaft by hand until it engages the shaft lock.

⚠ WARNING Do not engage the shaft lock button while rotary tool is running.

2. With the shaft lock button engaged, loosen (do not remove) the collet nut. Use the collet wrench if necessary.
3. Insert the bit or accessory shank fully into the collet.
4. With the shaft lock button engaged, finger tighten the collet nut until the bit or accessory shank is gripped by the collet.

NOTE: Be sure to read the instructions supplied with your Craftsman accessory for further information on its use.

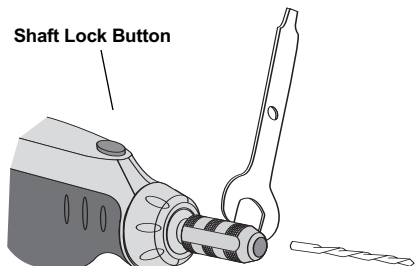

ASSEMBLY (CONTINUED)

Keyless Chuck

The keyless chuck is used in place of the standard collet and collet nut to easily and quickly remove and install some accessories.

The keyless chuck holds various accessories with shank sizes 1/32" to 1/8" and is intended for light duty accessories such as drill bits, sanding drums, polishing accessories, wire and bristle brushes and cut-off wheels.

1. See steps 1—3, Changing Collets on page 8 to install the keyless chuck.
2. Thread the keyless chuck onto the rotary tool shank.
3. Use the supplied wrench to completely tighten the keyless chuck if you are unable to apply sufficient tightening pressure to hold the bit or accessory.

Keyless Chuck

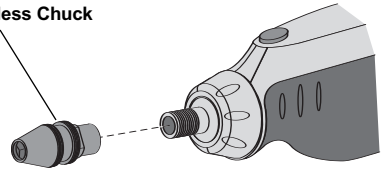

OPERATING INSTRUCTIONS

Learning To Use the Rotary Tool

Getting the most out of your rotary tool is a matter of learning how to let the speed and the feel of the tool in your hands work for you.



The first step in learning to use the rotary tool is to get the "feel" of it. Hold it in your hand and feel its weight and balance. Feel the taper of the housing. This taper permits the tool to be grasped much like a pen or pencil. The unique comfort grip on the nose allows for added comfort and control during use.

WARNING Always hold the tool away from your face. Accessories can be damaged during handling and can fly apart as they come up to speed. This is not common, but it does happen.

CAUTION When holding tool, do not cover the air vents with your hand. Blocking the air vents could cause the motor to overheat.

IMPORTANT! Practice on scrap material first to see how the tool's high-speed action performs. Keep in mind that your rotary tool will perform best by allowing the speed, along with the correct Craftsman accessory and attachment, do the work for you. Do not put pressure on the tool during use, if possible.

Instead, lower the spinning accessory lightly to the work surface and allow it to touch the point at which you want to begin. Concentrate on guiding the tool over the

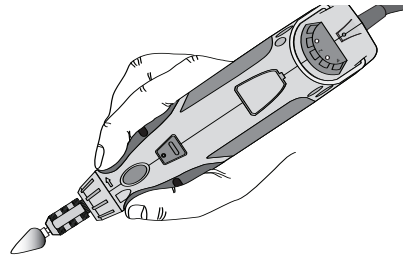

For best control in close work, grip the rotary tool like a pencil between your thumb and forefinger.

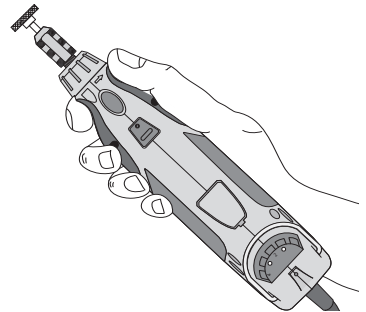

The "golf" grip method is used for more aggressive operations such as grinding or cutting.

work using very little pressure from your hand. Allow the accessory to do the work.

Usually it is better to make a series of passes with the tool rather than to do the entire job with one pass. A gentle touch gives the best control and reduces the chance for error.

OPERATING INSTRUCTIONS (CONTINUED)

Operating Speeds

To achieve the best results when working with different materials, set the variable speed control to suit the job. To select the right speed for the accessory in use, practice with scrap material first.

NOTE: Speed is affected by voltage changes. A reduced incoming voltage will slow the RPM of the tool, especially at the lowest setting. If your tool appears to be running slowly, increase the speed setting accordingly. The tool may not start at the lowest switch setting in areas where outlet voltage is less than 120 volts. Simply move the speed setting to a higher position to begin operation.

The Rotary Tool switch settings are marked on the speed control dial. Refer to the Speed Settings tables on pages 11 thru 13 for the correct speeds for specific accessories and materials.

Most jobs can be accomplished using the tool at the highest setting. However, certain materials (some plastics and metals) can be damaged by high-speed generated heat and should be worked on at relatively slow speeds.

Slow speed operation (15,000 RPM or less) is usually best for polishing operations employing the felt polishing accessories, delicate wood carving and fragile model parts. All brushing applications require lower speeds to avoid wire discharge from the holder. Let the performance of the tool do the work for you when using lower speed settings.

Higher speeds are better for drilling, carving, cutting, routing, shaping, cutting dadoes or rabbets in wood. Hardwoods, metals and glass require high speed operation also.

The settings for approximate RPM's are:

Switch Setting	Speed Range RPM
2	5,000-8,000
4	9,000-11,000
6	12,000-17,000
8	18,000-24,000
10	25,000-35,000

Set the Speed Control to the desired setting.

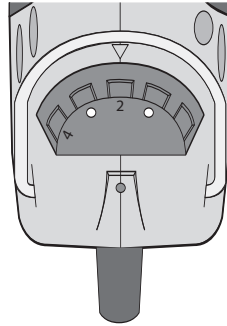

Some guidelines regarding tool speed:

- There is no accessory for the Craftsman Rotary tool that will drill or cut glass.
- Plastic and other materials that melt at low temperatures should be cut at low speeds.
- Polishing, buffing and cleaning with a wire brush must be done at speeds not greater than 15,000 RPM to prevent damage to the brush and your material.
- Wood should be cut at high speed.
- Iron or steel should be cut at high speed.
- If a high speed steel cutter starts to vibrate, it usually indicates that it is running too slow.
- Aluminum, copper alloys, lead alloys, zinc alloys and tin may be cut at various speeds, depending on the type of cutting being done. Use a paraffin (not water) or other suitable lubricant on the cutter to prevent the cut material from adhering to the cutter teeth.

NOTE: Increasing pressure on the tool is not the answer when it is not performing properly. Try a different accessory or speed setting to achieve the desired result. Please refer to the following Speed Setting tables.

SPEED SETTINGS

Use only Craftsman, high performance accessories.

High Speed Cutters

<i>Catalog Number</i>	<i>Soft Wood</i>	<i>Hard Wood</i>	<i>Laminates Plastic</i>	<i>Steel</i>	<i>Aluminum, Brass, etc.</i>	<i>Shell Stone</i>	<i>Ceramic</i>	<i>Glass</i>
25014	10	6	4	6	6	-	-	-
25012, 53070	10	10	4	6	10	-	-	-
25011, 53088	10	6	4	6	6	-	-	-
25088	10	10	4	6	6	-	-	-
25016	10	6	4	6	6	-	-	-

Small Engraving Cutters

<i>Catalog Number</i>	<i>Soft Wood</i>	<i>Hard Wood</i>	<i>Laminates Plastic</i>	<i>Steel</i>	<i>Aluminum, Brass, etc.</i>	<i>Shell Stone</i>	<i>Ceramic</i>	<i>Glass</i>
53074	10	10	6	8	6	-	-	-
53112	10	10	6	8	6	-	-	-
53076	10*	10*	6*	8	3	-	-	-

Diamond Wheel Points

<i>Catalog Number</i>	<i>Soft Wood</i>	<i>Hard Wood</i>	<i>Laminates Plastic</i>	<i>Steel</i>	<i>Aluminum, Brass, etc.</i>	<i>Shell Stone</i>	<i>Ceramic</i>	<i>Glass</i>
53137	10	8	-	-	-	10	10	10

Structured Tooth Tungsten Carbide Cutters

<i>Catalog Number</i>	<i>Soft Wood</i>	<i>Hard Wood</i>	<i>Laminates Plastic</i>	<i>Steel</i>	<i>Aluminum, Brass, etc.</i>	<i>Shell Stone</i>	<i>Ceramic</i>	<i>Glass</i>
53108, 53138	10	8	4	-	6	-	-	-

Tungsten Carbide Cutters

<i>Catalog Number</i>	<i>Soft Wood</i>	<i>Hard Wood</i>	<i>Laminates Plastic</i>	<i>Steel</i>	<i>Aluminum, Brass, etc.</i>	<i>Shell Stone</i>	<i>Ceramic</i>	<i>Glass</i>
53071, 53072, 53104	10	8	4	10	6	8	8-10	8-10
53073, 53105	-	-	-	-	-	8	8-10	8-10

High Speed Router Bits

(Use with cutting guide or shaper/router table)

<i>Catalog Number</i>	<i>Soft Wood</i>	<i>Hard Wood</i>	<i>Laminates Plastic</i>	<i>Steel</i>	<i>Aluminum, Brass, etc.</i>	<i>Shell Stone</i>	<i>Ceramic</i>	<i>Glass</i>
53071, 73096	10	6	-	-	-	-	-	-
53111, 53090, 53091	10	10	-	-	-	-	-	-
53092	10	8	-	-	-	-	-	-

Silicon Carbide Grinding Stones

<i>Catalog Number</i>	<i>Soft Wood</i>	<i>Hard Wood</i>	<i>Laminates Plastic</i>	<i>Steel</i>	<i>Aluminum, Brass, etc.</i>	<i>Shell Stone</i>	<i>Ceramic</i>	<i>Glass</i>
53079, 25062, 25063	-	-	6	10	4	6	10	10

SPEED SETTINGS (CONTINUED)

Use only Craftsman, high performance accessories.

Aluminum Oxide Grinding Stones

<i>Catalog Number</i>	<i>Soft Wood</i>	<i>Hard Wood</i>	<i>Laminates Plastic</i>	<i>Steel</i>	<i>Aluminum, Brass, etc.</i>	<i>Shell Stone</i>	<i>Ceramic</i>	<i>Glass</i>
25046, 25049, 25053	10	10	-	8	4	6	10	-
25057, 25059	10	10	-	8	4	6	10	-

Chain Saw Sharpening Stones

<i>Catalog Number</i>	<i>Soft Wood</i>	<i>Hard Wood</i>	<i>Laminates Plastic</i>	<i>Steel</i>	<i>Aluminum, Brass, etc.</i>	<i>Shell Stone</i>	<i>Ceramic</i>	<i>Glass</i>
36581, 36583	-	-	-	10	-	-	-	-

Cutting Accessories (See Warning-page 6)

<i>Catalog Number</i>	<i>Soft Wood</i>	<i>Hard Wood</i>	<i>Laminates Plastic</i>	<i>Steel</i>	<i>Aluminum, Brass, etc.</i>	<i>Shell Stone</i>	<i>Ceramic</i>	<i>Glass</i>
25024, 53114, 53088	8-10	8-10	2-4	10	10	10	10	-
53165	10	8-10	2-4	-	-	-	-	-
53134	For use on drywall. For best results, use at 35,000 rpm.							
53134	6-10	6-10	2-4	-	10	-	-	-
53136	-	-	-	-	-	-	10	-

Polishing Accessories

<i>Catalog Number</i>	<i>Soft Wood</i>	<i>Hard Wood</i>	<i>Laminates Plastic</i>	<i>Steel</i>	<i>Aluminum, Brass, etc.</i>	<i>Shell Stone</i>	<i>Ceramic</i>	<i>Glass</i>
53082	-	-	-	6	6	6	6	6
26033	-	-	-	6-8	6-8	6-8	6-8	6-8
53110	4	4	2-4	6	6	-	-	-
53120	-	4	-	4	-	-	-	-
25038, 25039, 53087	6	6	2	6	6	-	-	-
53131	4	4	-	4	4	4	-	-

Sanding Bands and Discs

<i>Catalog Number</i>	<i>Soft Wood</i>	<i>Hard Wood</i>	<i>Laminates Plastic</i>	<i>Steel</i>	<i>Aluminum, Brass, etc.</i>	<i>Shell Stone</i>	<i>Ceramic</i>	<i>Glass</i>
53116, 53117, 53118	2-10	2-10	2-6	10	10	2-10	2-10	-
25042, 53083, 25043	2-10	2-10	2-6	10	10	2-10	2-10	-
53084	8	8	2-4	-	2-4	-	-	-

SPEED SETTINGS (CONTINUED)

Use only Craftsman, high performance accessories.

Flapwheels

<i>Catalog Number</i>	<i>Soft Wood</i>	<i>Hard Wood</i>	<i>Laminates Plastic</i>	<i>Steel</i>	<i>Aluminum, Brass, etc.</i>	<i>Shell Stone</i>	<i>Ceramic</i>	<i>Glass</i>
53138, 53162	10	8	2	10	8-10	-	-	-

Finishing Abrasive Buffs

<i>Catalog Number</i>	<i>Soft Wood</i>	<i>Hard Wood</i>	<i>Laminates Plastic</i>	<i>Steel</i>	<i>Aluminum, Brass, etc.</i>	<i>Shell Stone</i>	<i>Ceramic</i>	<i>Glass</i>
53164	6	6	4	6	6	-	-	-

Grout Removal Bits

<i>Catalog Number</i>	<i>Soft Wood</i>	<i>Hard Wood</i>	<i>Laminates Plastic</i>	<i>Steel</i>	<i>Aluminum, Brass, etc.</i>	<i>Shell Stone</i>	<i>Ceramic</i>	<i>Glass</i>
53166	For use on wall and floor grout. Use with grout removal cutting guide.						-	6-8

MAINTENANCE

⚠ WARNING Preventative maintenance performed by unauthorized personnel may result in misplacing of internal wires and components which could cause serious hazard. We recommend that all tool service be performed by a Sears Parts and Repair Centers.

⚠ WARNING To avoid injury from unexpected starting or electrical shock, always remove plug from wall outlet before performing service or cleaning.

Carbon Brushes

The brushes in your tool have been engineered for many hours of dependable service.

To prepare the brushes for use, run the tool at full speed for 5 minutes under no load. This will properly "seat" the brushes, and extend the life of the tool.

To maintain peak efficiency of the motor, examine the brushes for wear every 50-60 hours.

⚠ CAUTION Using the tool with worn brushes will permanently damage the motor.

Use only original Craftsman replacement brushes.

Inspect the rotary tool brushes after 40-50 hours of use. If the rotary tool runs erratically, loses power, or makes unusual noises check the brushes for wear and possible replacement. Remember: brushes in the rotary tool are similar to oil in a car; the more you check/service, the better the performance.

Follow these steps to check/change the rotary tool brushes.

1. With the power cord unplugged, place the tool on a clean surface. Use the tool wrench to pry up and release the clip on the brush cover (Figure A).
2. Remove the brushes from the tool by pulling the shunt and brass clip which are attached to the brush (Figure B).

NOTE: Be sure to note how the brass clip slides out of the slot next to the brush pocket. Also, note how the detent on brass clip fits into brush pocket slot, which secures the brass clip into proper position.

3. Check each brush for wear. If brush is less than 3/8" long, or if contact end is rough or pitted, replace the brush.

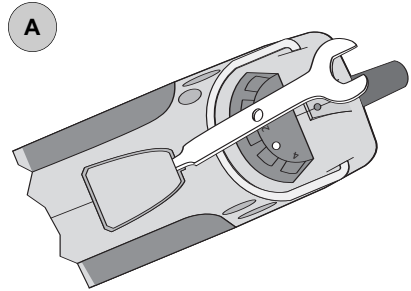

Removing Brush Cover

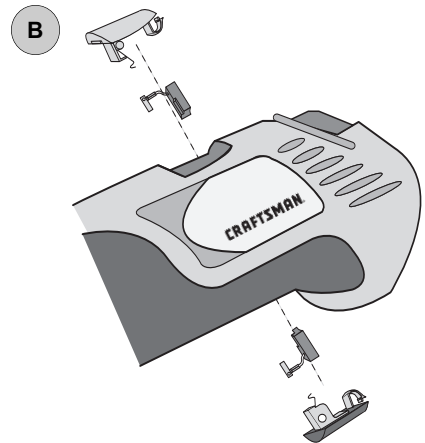

Removing/Inspecting Brushes

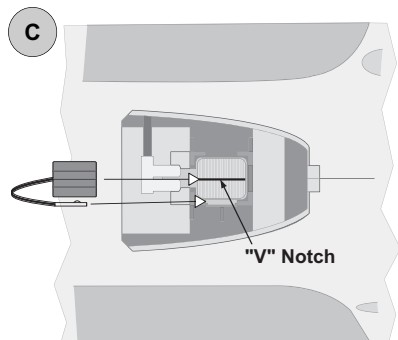

Installing Brushes

MAINTENANCE (CONTINUED)

4. Install existing or new brushes so the curved surface of the brush end matches the curvature of the motor commutator (as seen through the brush opening).

NOTE: The detent on the brass clip must fit into the slot on the side of the brush pocket, which secures the brass clip in the proper position (Figure C).

5. Reinstall brush covers by angling the non-clip end into the opening. Make certain brush spring is centered in the "V" notch on brush, then snap closed the clip end of the brush cover.
6. Plug power cord into a wall outlet. Run the rotary tool at full speed for 5 minutes under no load. This will properly seat the brushes and extend the life of the tool.

Tool Lubrication

There is no need to lubricate the rotary tool.

Cleaning The Tool

Ventilation openings and switch levers must be kept clean and free of foreign matter. Do not attempt to clean by inserting pointed objects through openings.



The tool may be cleaned with compressed air. Always wear safety goggles when cleaning tool with compressed air.



Certain cleaning agents and solvents will damage plastic parts. Some of these are: gasoline, carbon tetrachloride, chlorinated cleaning solvents, ammonia and household detergents that contain ammonia.

Clean the "soft grip" areas of the tool using a damp cloth. Tougher soiled areas may require more than one wipe application to get clean.

ACCESSORIES

For availability of all accessories and attachments, refer your local Sear center.

▲ WARNING Use only Craftsman, high-performance accessories. Other accessories are not designed for this tool and may lead to personal injury or property damage.

Drywall Cutting Bit



When using a template (outlet box) behind the drywall, cut in a counterclockwise direction.

Tile Cutting Bit

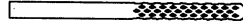

For use with wall tile, cement board and plaster.

Start the bit into the material at a 45° angle and then slowly bring it to a 90° angle to

High Speed Router Bits

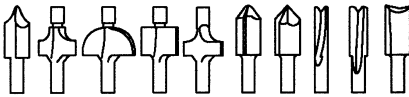

For routing, inlaying and mortising in wood and other soft materials. Use only with Craftsman Router Attachment or Shape/Router Table.

Multipurpose Cutting Bit



For use in wood, plastics, drywall, fiberglass, vinyl or aluminum siding, acoustical tile and laminates.

Start the bit into the material at a 45° angle and then slowly bring it to a 90° angle to begin the cut.

Mandrels

A mandrel is a shank with a threaded or screw head used with polishing accessories, cutting wheels, sanding discs and polishing points. The mandrel is a permanent shank, allowing for replacement of the worn head when necessary.

Small Screw Mandrel

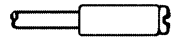

1/8" shank

Mandrel has a small screw at the tip and is used with emery and fiberglass cutting wheels, sanding discs and polishing wheels.

Screw Mandrel

For use with the felt polishing tip and felt polishing wheels.



1/8" shank

Threaded Tip Mandrel



1/8" shank

Mandrel has a threaded tip which threads into the polishing point accessory #427.

Aluminum Oxide Grinding Stones (red/brown)

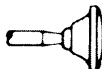

1/8" shank

These grinding stones come round, pointed or flat and are made of aluminum oxide. Use them for every possible grinding operation: sharpening lawn mower blades, screwdriver tips, knives, scissors, chisels and other cutting tools. Use to remove flash from metal castings, deburring any kind of metal. These grinding stones can be resharpened with a dressing stone. In machine shops, high speed drills and cutters are normally ground with aluminum oxide wheels.

Silicon Carbide Grinding Stones (blue/green)

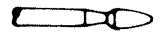

1/8" shank

Tougher than aluminum oxide points, these are made especially for use on hard materials such as glass and ceramics.

Diamond Wheel Points



3/32" shank

Used for fine detail work on wood, jade, ceramic, glass and other hard material. Bits are covered with diamond particles.

ACCESSORIES (CONTINUED)

High Speed Cutters

High speed cutters are used in carving, cutting and slotting wood, plastics and soft metals (such as aluminum, copper and brass). Made of high quality steel.

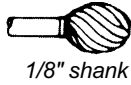

1/8" shank

Structured Tooth Tungsten Carbide Cutters

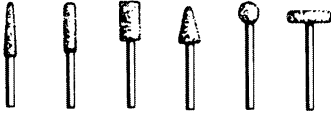

1/8" shank

These cutters feature fast cutting needle-sharp teeth for greater material removal with minimum loading. Use on fiberglass, wood, plastic, epoxy and rubber.

Wire Brushes

⚠ CAUTION Never use wire brushes at speeds greater than 15,000 rpm. Refer to Speed Settings (pages 10-12) for proper tool and setting.

Three different shapes of wire brushes are available in three different materials: stainless steel, brass and carbon wire.

Stainless steel brushes perform well on pewter, aluminum, stainless steel and other metals, without leaving rust. Brass brushes are non-sparking and softer than steel, making them good for use on soft metals like gold, copper and brass. Carbon wire brushes are good for general purpose cleaning.



1/8" shank

Bristle Brushes

Bristle brushes are used for cleaning tools on silverware, jewelry and antiques. The three shapes make it possible to get into tight corners and other difficult spaces. They can be used with polishing compound for faster cleaning or polishing.



1/8" shank

Aluminum Oxide Abrasive Wheels

Used to remove paint, deburr metal, polish stainless steel and other metals. Available in medium grit.



1/8" shank

Engraving Cutters

Engraving cutters come in a wide variety of sizes and shapes and are used for intricate work on ceramics (greenware), wood carvings, jewelry and scrimshaw. They are often used in making complicated printed circuit boards. They should not be used on steel and very hard materials, but are good for use on wood, plastic and soft metals.

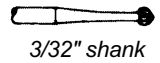

3/32" shank

Tungsten Carbide Cutters

Tungsten carbide cutters are long-lived cutters for use on hardened steel, fired ceramics and other very hard materials. They can be used for engraving on tools and garden equipment.

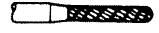

1/8" shank

Brushing Pressure

- The tips of a wire brush do the work. Operate the brush with the lightest pressure so only the tips of the wires come in contact with the work surface.
- If heavier pressure is used, the wires will become overstressed, resulting in a wiping action. If this continues, the life of the brush will be shortened by fatigue.
- Apply the brush to the work surface so the majority of the brush face makes full contact. Applying the edge or side of the brush to the work surface will result in wire breakage and shortened brush life.

CORRECT:
Wire tips doing the work.

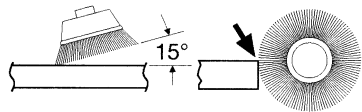

INCORRECT:
Excessive pressure can cause wire breakage.

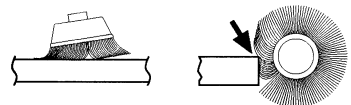

Grinding Wheel

Used for deburring, removing rust, and general purpose grinding. Use with Mandrel.

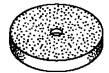

ACCESSORIES (CONTINUED)

Sanding Accessories

Sanding discs in fine, medium and coarse grades are made to fit mandrel. They can be used for nearly any small sanding job from model making to fine furniture finishing.

In addition, the drum sander makes it possible to shape wood, smooth fiberglass, sand inside curves and other difficult places. Drum bands are replaceable and come in fine and coarse grades.



1/8" shank

Flapwheels grind and polish flat or contoured surfaces. They are used most effectively as a finishing sander, after heavier surface sanding and material removal is completed. Flapwheels come in fine and coarse grades.

Bufs are a great finishing accessory for cleaning and light sanding. They work effectively on metal, glass, wood, aluminum and plastics. Bufs are available in medium and coarse grades.

ATTACHMENTS

The following attachments are part of the Craftsman Rotary Tool System; increasing the versatility of your rotary tool.

MultiSaw

The MultiSaw turns your rotary tool into a multipurpose saw that will allow you to make straight and curved cuts in a variety of materials. Scroll cutting patterns is now fast and easy. Using standard jigsaw blades, you can cut soft & hard wood, plywood, metal, PVC, plastic, and much more!



Planer

Convert your corded rotary tool into a planer.

- The planer is designed for two types of planing: straight planing and 45° planing, up to 2-18".
- In addition, the straight planing technique can be used for limited shaping and carving.
- Ideal for fixing a warped or stuck door!

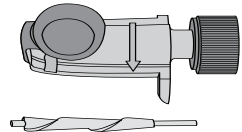

Flex Light

The flex light uses Lithium Ion batteries (batteries included).

- LED lighting provides visibility in dimly lit areas and increases light on detailed projects
- Easy to attach, no confusing wires or connections
- Attaches to Workstation and Plunge Router.

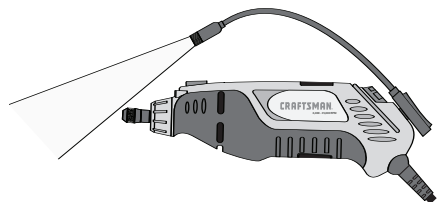

ATTACHMENTS (CONTINUED)

Flex Shaft

Ideal for hard-to-reach places and fine detail work.

- Quick connect attach system
- 36" long cable with new 5" bend radius provides more flexibility
- Comfort grip hand piece
- Integrated shaft lock button
- Holds up to 1/8" shank

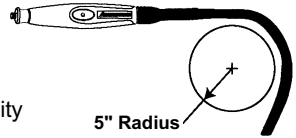

Work Station

Combines the versatility of the flex shaft holder with the utility of the drill press.

- Can be used as a stand-alone unit or mounted to a workbench
- Aluminum base for tough endurance
- Drill at 90° vertical and in increments of 15° up to 90° horizontal.
- Also functions as a flex shaft tool holder and a stationary tool holder
- Convenient holder for wrench, accessories, drill bits and point bits

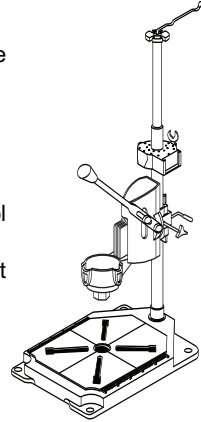

Plunge Router

Converts your corded rotary tool into a plunge router.

- Clear base
- Two depth stop
- Includes edge guide and circle guide
- Rout circles, parallel to edge, signs, inlay work, and lettering template adapters

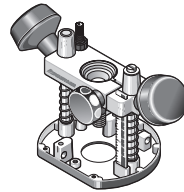

Grout Removal

Fast and easy way to regrout any room or replace a broken tile!

- Multiple side depth adjustment
- 30° angle for control cutting
- Guides 180° apart to keep bit centered between tiles
- Easy screw mounting
- Includes 1/16" grout removal bit

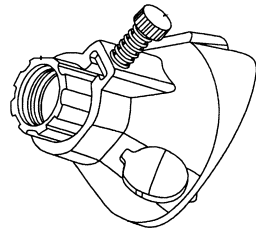

ATTACHMENTS (CONTINUED)

Cutting Guide

Provides controlled cutting in a variety of materials

- Allows for sturdy controlled cuts with maximum visibility
- Easy depth adjustment. Set to the correct cutting depth for the project material.

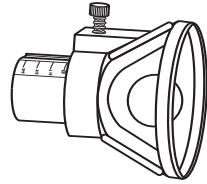

Shaper / Router Table

Converts your corded rotary tool into a bench mounted wood shaper.

- Features an adjustable fence and large 8" x 6" worktable
- Slot, groove, sand and trim edges

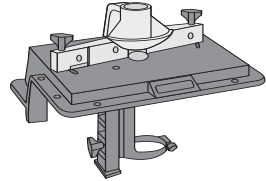

Lawn / Garden Sharpener

The fastest, easiest, safest way to sharpen your lawn mower blade and other garden tools.

- Guide provides optimum sharpening angle
- Sharpens most rotary lawn mower blades
- Includes sharpening stone

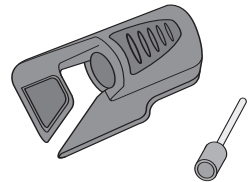

Chain Saw Sharpener

- Easily sharpen the dulllest of chains
- Contains: sharpening attachment, 3 sharpening stones, gauge, 2 spacers, wrench, instruction manual

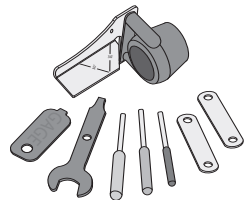

ATTACHMENTS (CONTINUED)

Right Angle

Enhances the versatility of the rotary tool by allowing you to get into hard-to-reach places.

- Ball bearings and spiral gears provide smooth and cool operation
- Coupling system allows you to orient the attachment on your tool in 12 different directions
- Quick disconnect system easily attaches to your rotary tool in place of the housing cap, no wrenches required

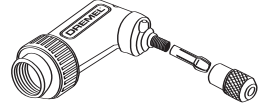

Flex Shaft Tool Holder

Conveniently suspends any Dremel rotary tool above your workbench.

- Perfect for use with the Flex-Shaft attachment
- Clamps to workbenches up to 1-3/4" thick, and adjusts in height from 12" to 42"
- Store extra bits on base

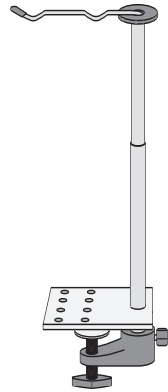

Tool Holder and Base

- Firmly holds rotary tools in any position
- Control workpiece (hands free) for better results.

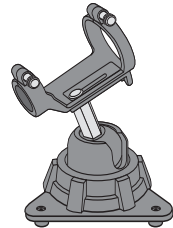

SERVICE PARTS

Craftsman Rotary Tool Model 572.611200

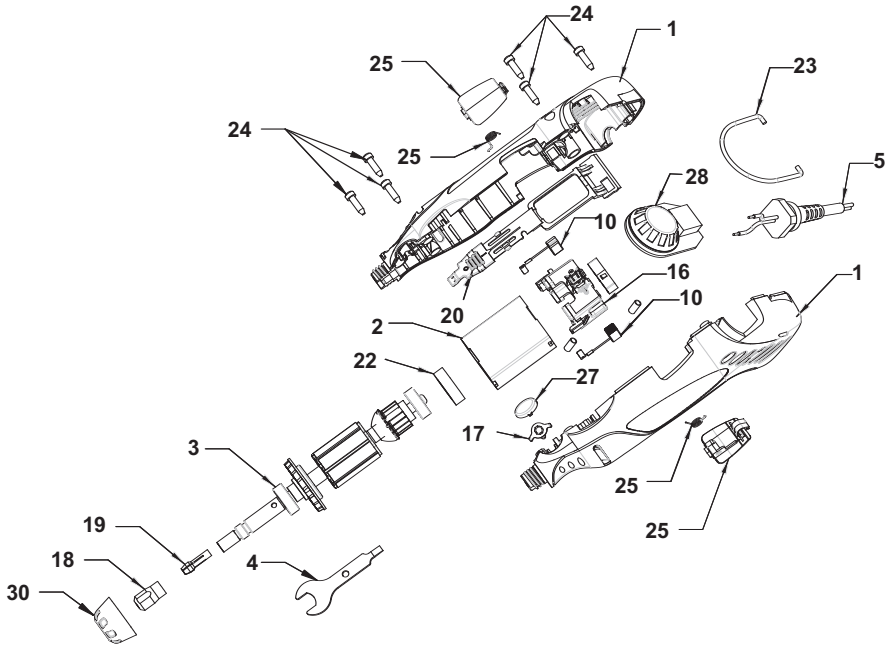

Ref.	Part No.	Description	Ref.	Part No.	Description
1	2610920980	Housing Set	18	2610922763	Collet Nut
2	2610920701	Field Assembly	19	2615110480	1/8" Collet (In Tool)
3	2610920702	Armature and Bearing Assembly	20	2610920710	Switch Assembly
4	2615990962	Wrench	22	2610914379	Rubber Bearing Sleeve
5	2615294041	Cord	23	2610920718	Hanger
10	2610920705	Brush Spring (Pair)	24	2615294035	Screws (Individual)
16	261920709	Brush Holder Assembly	25	2610921563	Brush Door (Pair)
17	2610920972	Collet Lock & Spring	27	2610920716	Glamour Cap
			28	2640920711	Speed Control
			30	2610920717	Housing Cap

Notes:

Notes:

Notes:

Get it fixed, at your home or ours!

Your Home

For repair **in your home** of **all** major brand appliances, lawn and garden equipment, or heating and cooling systems, **no matter who made it, no matter who sold it!**

For the replacement parts, accessories and owner's manuals that you need to do-it-yourself.

For Sears professional installation of home appliances and items like garage door openers and water heaters.

1-800-4-MY-HOME[®] Anytime, day or night
(1-800-469-4663) (U.S.A. and Canada)
www.sears.com www.sears.ca

Our Home

For repair of carry-in products like vacuums, lawn equipment, and electronics, call or go on-line for the nearest **Sears Parts and Repair Center.**

1-800-488-1222 Anytime, day or night (U.S.A. only)
www.sears.com

To purchase a protection agreement on a product serviced by Sears:

1-800-827-6655 (U.S.A.) **1-800-361-6665** (Canada)

Para pedir servicio de reparación a domicilio, y para ordenar piezas:

1-888-SU-HOGARSM
(1-888-784-6427)

Au Canada pour service en français:

1-800-LE-FOYER^{MC}
(1-800-533-6937)
www.sears.ca

SEARS

© Sears, Roebuck and Co.

® Registered Trademark / TM Trademark / SM Service Mark of Sears, Roebuck and Co.

© Marca Registrada / TM Marca de F. brica / SM Marca de Servicio de Sears, Roebuck and Co.

^{MC} Marque de commerce / ^{MD} Marque déposée de Sears, Roebuck and Co.

Free Manuals Download Website

<http://myh66.com>

<http://usermanuals.us>

<http://www.somanuals.com>

<http://www.4manuals.cc>

<http://www.manual-lib.com>

<http://www.404manual.com>

<http://www.luxmanual.com>

<http://aubethermostatmanual.com>

Golf course search by state

<http://golfingnear.com>

Email search by domain

<http://emailbydomain.com>

Auto manuals search

<http://auto.somanuals.com>

TV manuals search

<http://tv.somanuals.com>