

User's Guide for the CRATE AUDIO CMX62

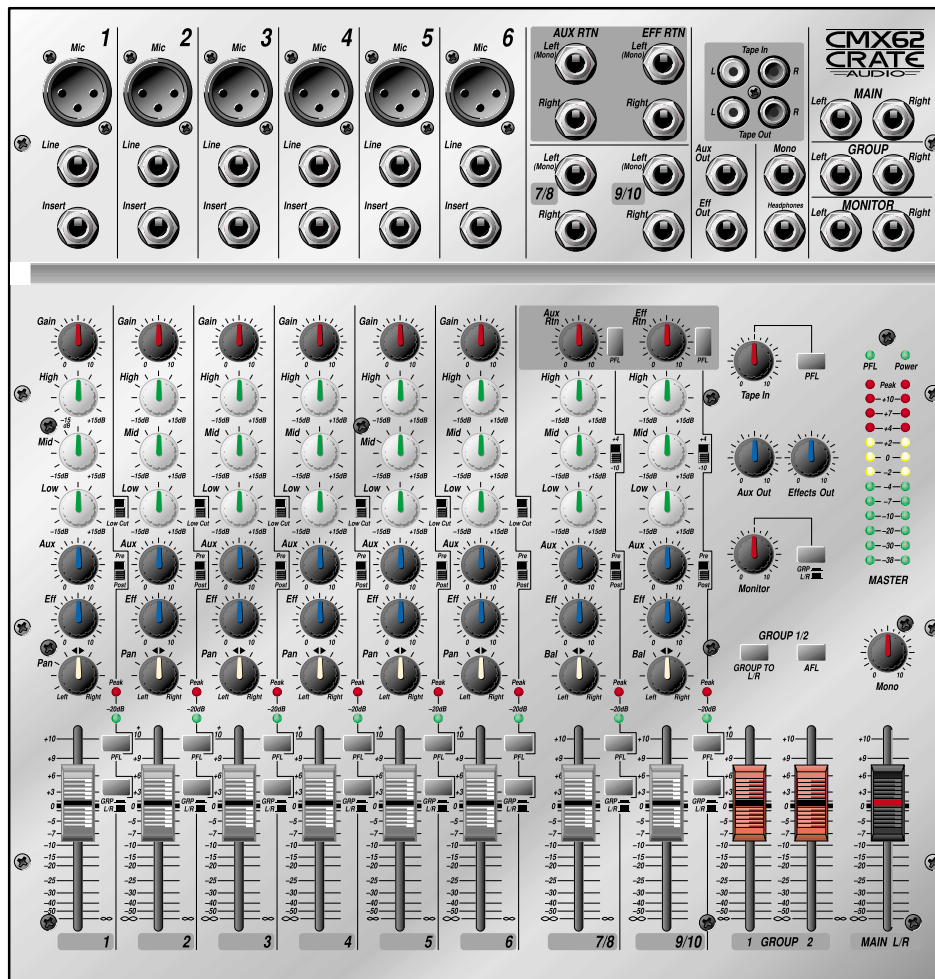

Stereo Console Mixer

In order to achieve maximum performance from your new Crate Audio Mixer we recommend that you read this user's guide prior to its use.

CRATE
AUDIO

Congratulations.

You have selected one of the finest pieces of Audio Reproduction Equipment available for use on stage, in the home studio, or for "institutional" use: a Crate Audio Stereo Console Mixer. In order to derive the most benefit from the mixer, and to fully understand and appreciate its flexibility and versatility, please familiarize yourself with the mixer by reading through this User's Guide prior to its use.

Thank You, from Crate Audio.

Table of Contents:

- Introduction3
- Features3
- About This Manual3
- The Mono Input Channels4
- The Stereo Input Channels5
- The Master Section6,7
- The Rear Panel7
- Applications:
 - Basic Mono Operation8
 - Home Studio9
 - DJ Setup10
 - House of Worship Installation11
 - Separating Vocals and Instruments12
 - External Effects and Recorders13
- Equalization Diagrams14
- Differences in Cable Types14
- Gain Level Diagram15
- System Block Diagram15
- Technical Specificationsback cover

CAUTION RISK OF ELECTRIC SHOCK DO NOT OPEN	PRECAUCION RIESGO DE CORRIENTAZO NO ABRA	ATTENTION RISQUE D'ELECTROCUTION NE PAS OUVRIR	VORSICHT ELEKTRISCHE SCHLAGEGFAHR NICHT OFFENEN																								
CAUTION: TO REDUCE THE RISK OF ELECTRIC SHOCK, DO NOT REMOVE COVER. NO USER-SERVICEABLE PARTS INSIDE. REFER SERVICING TO QUALIFIED SERVICE PERSONNEL.	PRECAUCION PARA DISMINUIR EL RIESGO DE CORRIENTAZO NO ABRA LA CUBIERTA. NO HAY PIEZAS ADENTRO QUE EL USUARIO PUEDE REPARAR. DEJE TODO MANTENIMIENTO A LOS TECNICOS CALIFICADOS.	ATTENTION: POUR REDUIRE D'ELECTROCUTION NE PAS ENLEVER LE COUVERCLE. AUCUNE PIECE INTERNE N'EST REPARABLE PAR L'UTILISATEUR. POUR TOUTE REPARATION, S'ADRESSER A UN TECHNICIEN QUALIFIE.	VORSICHT: ZUR MINIMIERUNG ELEKTRISCHER SCHLAGEGFAHR NICHT DEN DECKEL ABENHMEN. INTERNE TEILE KONNEN NICHT VOM BENUTZER GEWARTET WERDEN. DIE WARTUNG IS QUALIFIZIERTEM WARTUNGSPERSONAL ZU UBERLASSEN.																								
THIS EQUIPMENT HAS BEEN DESIGNED AND ENGINEERED TO PROVIDE SAFE AND RELIABLE OPERATION. IN ORDER TO PROLONG THE LIFE OF THE UNIT AND PREVENT ACCIDENTAL DAMAGES OR INJURY, PLEASE FOLLOW THESE PRECAUTIONARY GUIDELINES:	CAUTION: TO REDUCE THE RISK OF ELECTRIC SHOCK, DO NOT OPEN CHASSIS; DO NOT DEFEAT OR REMOVE THE GROUND PIN OF THE POWER CORD; CONNECT ONLY TO A PROPERLY GROUNDED AC POWER OUTLET.	WARNING: TO REDUCE THE RISK OF FIRE OR ELECTRIC SHOCK, DO NOT EXPOSE THIS EQUIPMENT TO RAIN OR MOISTURE. CAUTION: NO USER-SERVICEABLE PARTS INSIDE. REFER SERVICING TO QUALIFIED SERVICE PERSONNEL.	CAUTION: OUR AMPLIFIERS ARE CAPABLE OF PRODUCING HIGH SOUND PRESSURE LEVELS. CONTINUED EXPOSURE TO HIGH SOUND PRESSURE LEVELS CAN CAUSE PERMANENT HEARING IMPAIRMENT OR LOSS. USER CAUTION IS ADVISED AND EAR PROTECTION IS RECOMMENDED IF UNIT IS OPERATED AT HIGH VOLUME.																								
ESTE APARATO HA SIDO DISEÑADO Y CONSTRUÍDO PARA PROVEER AÑOS DE OPERACION SEGURA Y CONFIABLE. PARA PROLONGAR LA VIDA DE ESTA UNIDAD E IMPEDIR DAÑOS ACCIDENTALES POR FAVOR SIGA ESTAS INSTRUCCIONES PREVENTIVAS:	PRECAUCION: PARA DISMINUIR EL RIESGO DE DESCARGAS ELECTRICAS: (1) NO ABRA LA CUBIERTA. (2) NO ES RECOMENDABLE REMOVER O DESACTIVAR LA PATA DEL POLO A TIERRA DEL CABLE DE CORRIENTE. CONECTE CORRECTAMENTE A UNA TOMA DE CORRIENTE A TIERRA.	ADVERTENCIA: PARA EVITAR DESCARGAS ELECTRICAS O PELIGRO DE INCENDIO, NO DEJE ESTE APARATO EXPUESTO A LA LLUVIA O HUMEDAD. PRECAUCION: NO HAY PIEZAS ADENTRO QUE EL USUARIO PUEDE REPARAR. DEJE TODO MANTENIMIENTO A LOS TECNICOS CALIFICADOS.	PRECAUCION: NUESTROS AMPLIFICADORES PUEDEN PRODUCIR NIVELES DE PRESION DE SONIDO ALTO. EXPOSICION CONTINUADA A LOS NIVELES DE PRESION DE SONIDO ALTO PUEDE CAUSAR DAÑO PERMANENTE A SU OIDO. ES ACONSEJADO QUE USE PRECAUCION AL USUARIO Y ES RECOMENDADO PROTECCION PARA LOS OIDOS SI LA UNIDAD ES OPERADA A VOLUMEN ALTO.																								
THE CHART BELOW SHOWS THE U.S. GOVERNMENT'S OCCUPATIONAL SAFETY AND HEALTH ADMINISTRATION (OSHA) REGULATIONS WHICH WERE IN EFFECT AT THE TIME OF THIS PUBLICATION FOR PERMISSIBLE NOISE EXPOSURE, PER 29CFR1910.95, TABLE G-16:																											
<table border="1" style="width: 100%; border-collapse: collapse; font-size: x-small;"> <thead> <tr> <th>SOUND LEVEL DBA, SLOW RESPONSE</th> <th>DURATION PER DAY IN HOURS</th> </tr> </thead> <tbody> <tr><td>90</td><td>8</td></tr> <tr><td>92</td><td>6</td></tr> <tr><td>95</td><td>4</td></tr> </tbody> </table>	SOUND LEVEL DBA, SLOW RESPONSE	DURATION PER DAY IN HOURS	90	8	92	6	95	4	<table border="1" style="width: 100%; border-collapse: collapse; font-size: x-small;"> <thead> <tr> <th>SOUND LEVEL DBA, SLOW RESPONSE</th> <th>DURATION PER DAY IN HOURS</th> </tr> </thead> <tbody> <tr><td>97</td><td>3</td></tr> <tr><td>100</td><td>2</td></tr> <tr><td>102</td><td>1 - 1 1/2</td></tr> </tbody> </table>	SOUND LEVEL DBA, SLOW RESPONSE	DURATION PER DAY IN HOURS	97	3	100	2	102	1 - 1 1/2	<table border="1" style="width: 100%; border-collapse: collapse; font-size: x-small;"> <thead> <tr> <th>SOUND LEVEL DBA, SLOW RESPONSE</th> <th>DURATION PER DAY IN HOURS</th> </tr> </thead> <tbody> <tr><td>105</td><td>1</td></tr> <tr><td>110</td><td>1/2</td></tr> <tr><td>115</td><td>1/4 or less</td></tr> </tbody> </table>	SOUND LEVEL DBA, SLOW RESPONSE	DURATION PER DAY IN HOURS	105	1	110	1/2	115	1/4 or less	
SOUND LEVEL DBA, SLOW RESPONSE	DURATION PER DAY IN HOURS																										
90	8																										
92	6																										
95	4																										
SOUND LEVEL DBA, SLOW RESPONSE	DURATION PER DAY IN HOURS																										
97	3																										
100	2																										
102	1 - 1 1/2																										
SOUND LEVEL DBA, SLOW RESPONSE	DURATION PER DAY IN HOURS																										
105	1																										
110	1/2																										
115	1/4 or less																										
ACCORDING TO OSHA, ANY EXPOSURE IN EXCESS TO THESE AMOUNTS LISTED ABOVE COULD RESULT IN SOME HEARING LOSS.																											
EXPLANATION OF GRAPHICAL SYMBOLS: EXPLICACION DE SIMBOLOS GRAFICOS:	= "DANGEROUS VOLTAGE" "VOLTAJE PELIGROSO" "DANGER HAUTE TENSION" "GEFAHRICHE SPANNUNG"	= "IT IS NECESSARY FOR THE USER TO REFER TO THE INSTRUCTION MANUAL" "ES NECESARIO QUE EL USUARIO SE REFIERA AL MANUAL DE INSTRUCCIONES." "REFERREZ-VOUS AU MANUAL D'UTILISATION" "UNBEDINGT IN DER BEDIENUNGSANLEITUNG NACHSCHLAGEN"																									

Introduction:

In the world of professional sound reinforcement and audio reproduction there is no room for compromise. It is absolutely vital that the emotions of a performance are projected to your audience, not just sounds. Your new Crate Audio CMX62 Stereo Console Mixer is a powerful tool which allows you to successfully bridge the gap between performers and audience without losing any of the "life" of the performance in the process. No matter what your particular application, your Crate Audio mixer is ready to meet the challenge with a level of performance and control unequaled by its competition.

Crate Audio mixers are the result of our many years of experience with high-performance audio equipment combined with our extensive research and development procedures and guided by our inherent love of musical performances. Each mixer is built using a variety of innovative construction methods making it truly reliable and incredibly roadworthy. Its diverse features offer you an extremely high degree of versatility and flexibility regardless of application and it is designed to keep you constantly in total control of your performing environment, always with the best possible sound.

Features:

Crate Audio mixers combine the latest technology with contemporary styling and flexible features. Exceptionally low noise, incredible headroom and outstanding features make the Crate Audio mixer perfect for use on stage, in the home studio, or for "institutional" use. This unique mixer offers stereo Tape In and Out jacks with Level controls, switchable Phantom Power, a level-controllable Headphones jack, dual 12-step LED ladders with Peak indicators, and more. Each of the six mono input channels offers you the choice of balanced XLR Low-Z or balanced 1/4" Hi-Z Input jacks, three bands of equalization, a Low Cut switch, a Pan control, a pre/post switchable Aux send and an Effects send. Gain controls for each mono channel and signal and peak LEDs for all channels allow for optimum signal-to-noise ratios. High-quality sliding faders allow smooth and precise control over each channel's output. Two stereo line-level input channels are provided for additional flexibility. Every channel features a Group/Main L/R assign switch and a PFL (pre-fader listen) switch for increased versatility and control. The stereo channels feature a +4/-10dBv input sensitivity switch to accommodate a wide range of input signals.

The color-coded knobs help you know at a glance if you're reaching for a Level knob, an EQ control, a Pan pot or Master slider.

These mixers are adaptable for mounting in a standard 19" rack if so desired. Your Crate Audio dealer has the optional rack-mount ears for the mixer.

About this Manual:

This manual is the compilation of many hours of discussions with engineers, musicians, experts in the field of sound reproduction and novices. While we strive to provide as comprehensive and informative a manual as possible, we realize we cannot convey every application imaginable or answer every possible question. We have endeavored to cover as much as is practical in this owner's manual and have provided suggested wiring diagrams for you to use as a starting point for your application.

The Mono Input Channels (1 – 6):

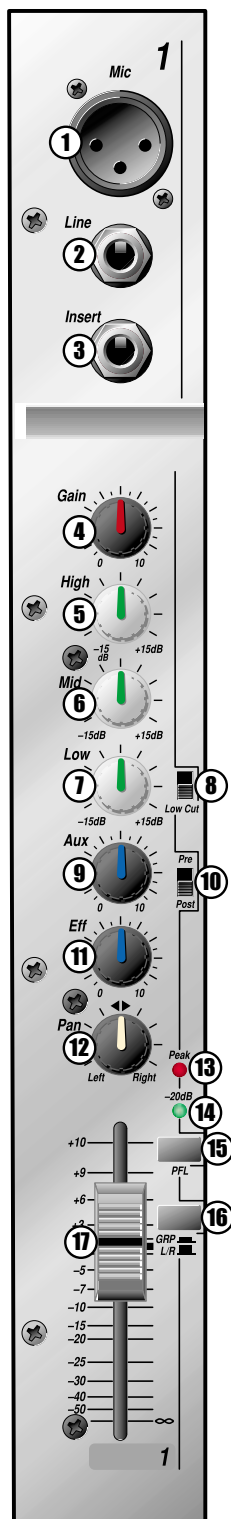

- 1 **MIC IN:** An XLR jack for balanced Low-Z mic inputs. When using a condenser mic, the Phantom Power switch (#63, rear panel - page 7) must be activated.
- 2 **LINE:** A Tip/Ring/Sleeve 1/4" jack for balanced Hi-Z mics, instruments, drum machines, and similar high impedance line level signals.
- 3 **INSERT:** A Tip/Ring/Sleeve 1/4" jack for adding an external signal processor to the channel. The wiring diagram for this jack is shown on page 13. Applications information is shown on pages 8 – 13.
- 4 **GAIN:** Adjusts the input signal level. Proper setting causes the Peak LED (#13) to flash at strong input signals.
- 5 **HIGH:** Controls the high frequency level for the channel. Allows $\pm 15\text{dB}$ @ 12kHz. Shelving type.
- 6 **MID:** Controls the middle frequency level for the channel. Allows $\pm 15\text{dB}$ @ 800Hz. Bandpass type.
- 7 **LOW:** This controls the low frequency level for the channel. Allows $\pm 15\text{dB}$ @ 70Hz. Shelving type.
•Additional EQ information is on page 14.
- 8 **LOW CUT:** Reduces the low frequency output of the channel at a rate of 18dB per octave at 75Hz. Active in the up position.
- 9 **AUX:** Controls the level of the signal sent from the channel to the Aux Out master control (#49). Use as a monitor send (Pre/Post switch, #10, in the "Pre" position) or as an effects loop send (Pre/Post switch, #10, in the "Post" position).
- 10 **PRE/POST:** The signal sent by the Aux control (#9) can be set to either pre-fader (switch in the "Pre" position) or post-fader (switch in the "Post" position).
- 11 **EFF:** Controls the level of the signal sent from the channel to the Eff Out master control (#50). Use as an effects loop send.
- 12 **PAN:** Divides the signal proportionally between the left and right channels of the Main L/R fader (#60) or the Group 1/2 faders (#59), depending on the setting of the Grp / L/R switch (#16).
- 13 **PEAK LED:** Illuminates when the input signal level is within 6dB of clipping. Proper setting of the Gain control (#4) will cause this LED to flash only on strong input signals.
- 14 **-20dB LED:** Illuminates when the input signal level is above -20dBv. This serves as a "signal present" LED.
- 15 **PFL:** This switch, when depressed, sends the channel's signal to the Monitor master control (#51). The Output LED Meters (#57) are also switched to monitor this signal, which is pre-fader. The PFL LED (#55) illuminates to indicate that the Headphones (#39), Monitor (#42) and LED Meters (#57) are now responding to the PFL selection.
- 16 **GRP / L/R:** This switch determines whether the signal is sent to the Group 1/2 master faders (#59) or the Main L/R master fader (#60).
- 17 **FADER:** Controls the level of the signal sent to either the Group 1/2 faders (#59) or the Main L/R fader (#60), depending on the setting of the Grp / L/R switch (#16).

The Stereo Input Channels (7 – 10):

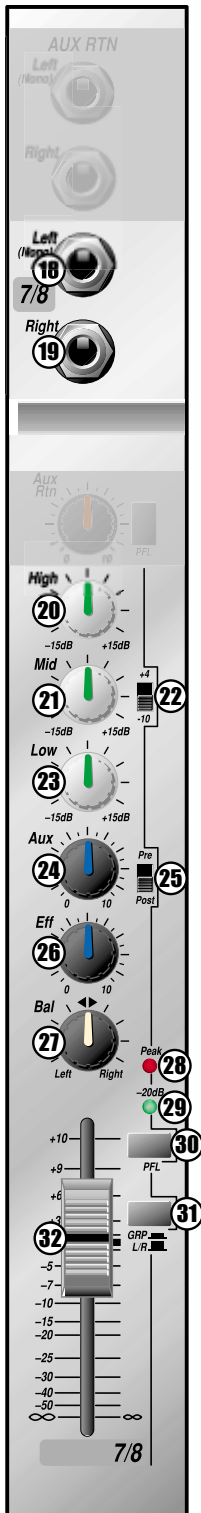

- 18 **LEFT/MONO:** A Tip/Sleeve 1/4" jack for instruments, drum machines, tape/CD channels and similar high impedance signals. For stereo inputs use this jack for the left channel input and the Right jack (#19) for the right channel input. For mono inputs use this jack only.
- 19 **RIGHT:** A Tip/Sleeve 1/4" jack for instruments, drum machines, tape/CD channels and similar high impedance signals. For stereo inputs use this jack for the right channel input and the Left/Mono jack (#18) for the left channel input. For mono inputs use the Left/Mono jack (#18) only.
- 20 **HIGH:** Controls the high frequency level for the channel. Allows $\pm 15\text{dB}$ @ 12kHz. Shelving type.
- 21 **MID:** Controls the middle frequency level for the channel. Allows $\pm 15\text{dB}$ @ 800Hz. Bandpass type
- 22 **+4/-10 SWITCH:** This sets the input sensitivity of the channel to either +4dBv for use with professional equipment (such as DAT players, mic preamps, etc.) or -10dBv for use with semi-pro equipment (such as tape decks, CD players, etc.).
- 23 **LOW:** This controls the low frequency level for the channel. Allows $\pm 15\text{dB}$ @ 70Hz. Shelving type.
 - **Additional EQ information is on page 14.**
- 24 **AUX:** Controls the level of the signal sent from the channel to the Aux Out master control (#49). Use as a monitor send (Pre/Post switch, #25, in the "Pre" position) or as an effects loop send (Pre/Post switch, #25, in the "Post" position).
- 25 **PRE/POST:** The signal sent by the Aux control (#24) can be set to either pre-fader (switch in the "Pre" position) or post-fader (switch in the "Post" position).
- 26 **EFF:** Controls the level of the signal sent from the channel to the Eff Out master control (#50). Use as an effects loop send.
- 27 **BAL:** Divides the signal proportionally between the left and right channels of the Main L/R fader (#60) or the Group 1/2 faders (#59), depending on the setting of the Grp / L/R switch (#31).
- 28 **PEAK LED:** Illuminates when the input signal level is within 6dB of clipping. Proper setting of the input signal level and the +4/-10 switch (#22) will cause this LED to flash only on strong input signals.
- 29 **-20dB LED:** Illuminates when the input signal level is above -20dBv. This serves as a "signal present" LED.
- 30 **PFL:** This switch, when depressed, sends the channel's signal to the Monitor master control (#51). The Output LED Meters (#57) are also switched to monitor this signal, which is pre-fader. The PFL LED (#55) illuminates to indicate that the Headphones (#39), Monitor (#42) and LED Meters (#57) are now responding to the PFL selection.
- 31 **GRP / L/R:** This switch determines whether the signal is sent to the Group 1/2 master faders (#59) or the Main L/R master fader (#60).
- 32 **FADER:** Controls the level of the signal sent to either the Main L/R fader (#60) or the Group 1/2 faders (#59), depending on the setting of the Grp / L/R switch (#31).

The Master Section:

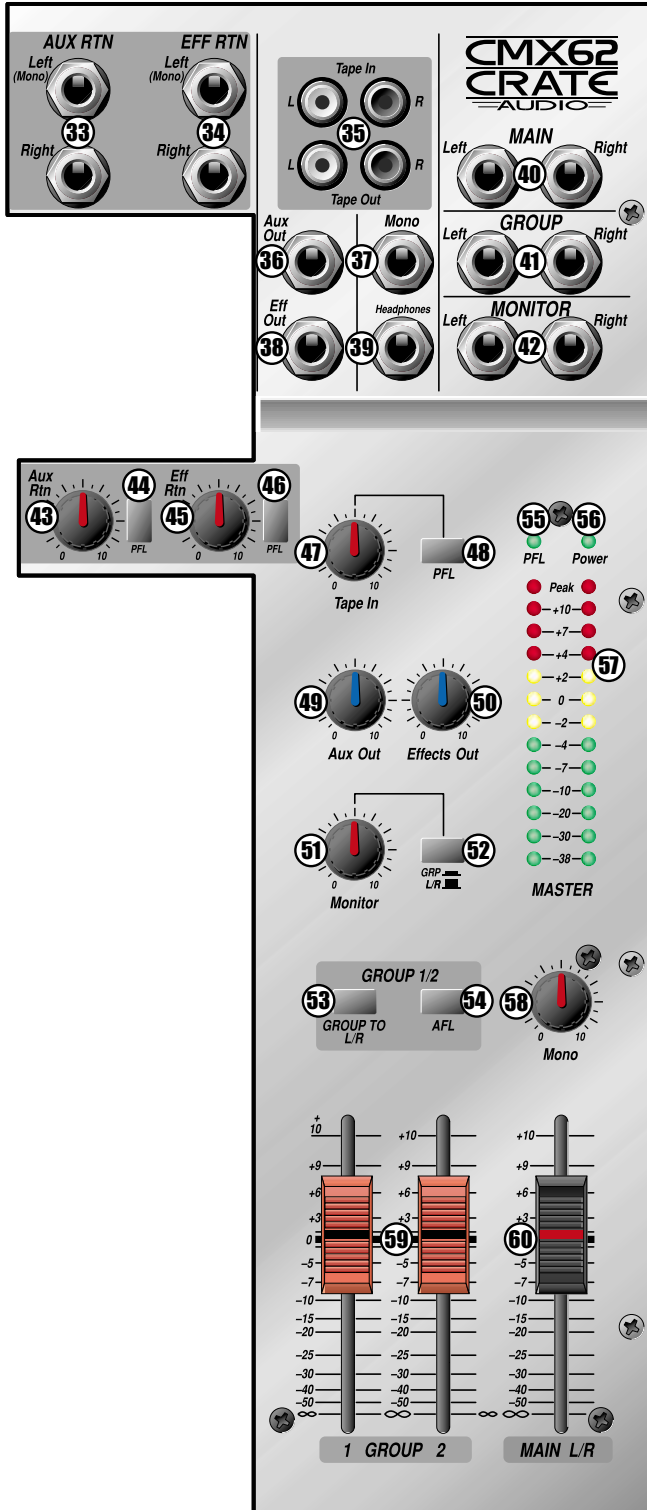

- 33 **AUX RTN:** Returns the stereo or mono signal from an external device. Stereo devices use both the Left and Right jacks; mono devices use only the Left jack.
- 34 **EFF RTN:** Returns the effected signal from an external effects device. Stereo devices use both the Left and Right jacks; mono devices use only the Left jack.
- 35 **TAPE IN/TAPE OUT:** Connect to the record and play jacks of an external tape deck. (See page 13.)
- 36 **AUX OUT:** Sends the Aux signals to an external device. The mix at this jack is determined by the setting of each channel's Aux control (#9, #24).
- 37 **MONO:** The signal at this jack is a summed mono version of the Main L/R signals. The level at this jack is controlled by the Mono master control (#58).
- 38 **EFF OUT:** Sends the Effect signal to an external effects device. The mix at this jack is determined by the setting of each channel's Eff control (#11, #26).
- 39 **HEADPHONES:** Normal operation: monitors the Main L/R or Group 1/2 signals, depending on the setting of the Grp / L/R master switch (#52). When one or more of the PFL or AFL buttons are depressed the signal at this jack is switched to monitor only the PFL selection(s). The signal level at this jack is controlled by the Monitor master control (#51).
- 40 **MAIN OUTS:** These balanced jacks send the Main L/R output signals to the house amplifier(s). (See pages 8-12.) The signal level at these jacks is controlled by the Main L/R fader (#60).
- 41 **GROUP OUTS:** These balanced jacks send the Group 1/2 output signals to the house amplifier(s). (See pages 8-12.) The signal level at these jacks is controlled by the Group 1/2 fader (#59).
- 42 **MONITOR OUTS:** These balanced jacks send the Monitor output signals to the local reference monitor amplifier(s). (See pages 8-12.) The signal level at these jacks is controlled by the Monitor master control (#51).
- 43 **AUX RTN:** Controls the signal level sent from the Aux Rtn jacks (#34) to the Main L/R bus.
- 44 **AUX PFL:** This switch, when depressed, sends the signal from the Aux Rtn jacks (#33) to the Monitor master control (#51). The Output LED Meters (#57) are also switched to monitor this signal, which is pre-level control. The PFL LED (#55) illuminates to indicate that the Headphones (#39), Monitor (#42) and LED Meters (#57) are now responding to the PFL selection.
- 45 **EFF RTN:** Controls the signal level sent from the Aux Rtn jacks (#33) to the Main L/R bus.
- 46 **EFF PFL:** This switch, when depressed, sends signal from the Eff Rtn jacks (#34) to the Monitor master control (#51). The Output LED Meters (#57) are also switched to monitor this signal, which is pre-level control. The PFL LED (#55) illuminates to indicate that the Headphones (#39), Monitor (#42) and LED Meters (#57) are now responding to the PFL selection.
- 47 **TAPE IN:** Controls the level of the signal from the Tape In jacks (#35) to the Main L/R bus. *To avoid feedback, this control must be rotated fully counter clockwise ("0" position) when using both sets of Tape In and Out jacks during recording.*

The Master Section (continued):

- 48 **TAPE IN PFL:** This switch, when depressed, sends the signal from the tape In jacks (#35) to the Monitor master control (#51). The Output LED Meters (#57) are also switched to monitor this signal, which is pre-level control. The PFL LED (#55) illuminates to indicate that the Headphones (#39), Monitor (#42) and LED Meters (#57) are now responding to the PFL selection.
- 49 **AUX OUT:** Controls the level of the signal sent to the Aux Out jack (#36).
- 50 **EFFECTS OUT:** Controls the level of the signal sent to the Eff Out jack (#38).
- 51 **MONITOR:** Controls the level of the signal sent to the Monitor jacks (#42).
- 52 **GRP / L/R:** This switch determines whether the Monitor section is monitoring the Main L/R output or the Group 1/2 output.
- 53 **GROUP TO L/R:** This switch, when depressed, sends the Group 1/2 signal to the Main L/R fader (#60).
- 54 **AFL:** This switch, when depressed, sends the Group 1/2 post-fader signal to the Monitor master control (#51).
- 55 **PFL LED:** This LED illuminates when any of the PFL or the AFL switches are depressed, indicating that the Meter (#57) is monitoring a PFL selection.
- 56 **POWER LED:** This LED illuminates when the mixer is plugged into an AC source and the Power switch (#62, rear panel) is at the On position (“-” depressed).
- 57 **METER:** This dual 12-stage LED meter monitors the Main L/R output signals under normal conditions – if any of the PFL / AFL switches are depressed, the PFL LED (#55) will illuminate and the meters will monitor the PFL source(s). The Peak LEDs will illuminate whenever the output signal is near clipping. If this happens, reduce the master faders until the Peak LEDs no longer flash.
- 58 **MONO:** Controls the level of the signal at the Mono jack (#37). This signal is a mono summed version of the Main L/R signals.
- 59 **GROUP 1/2 FADERS:** Control the Group 1 and 2 master signal levels sent to the Group 1 and 2 jacks (#41).
- 60 **MAIN L/R FADER:** Controls the Main master signal level sent to the Main Left/Right jacks (#40).

The Rear Panel:



- 61 **POWER CONNECTOR:** Fasten the threaded collar of the supplied AC power supply to this connector. Align the pins of the power supply with those of the connector, press into place, then tighten the threaded collar onto the connector securely.
 - 62 **POWER:** Use this switch to turn the mixer on (“-” depressed) and off.
 - 63 **PHANTOM POWER:** When using any condenser microphone that requires phantom power use the tip of a small screwdriver to slide the corresponding DIP switch to the On position (switch down). This applies phantom power to the appropriate channel. Phantom power is only available if the Master On/Off switch (#64) is in the On position. The numbers below the switches correspond to channels 1 – 6 of the mixer.
 - 64 **MASTER ON/OFF:** This switch turns the phantom power supply on and off. This switch must be on for the channel DIP switches (#63) to function.
- NOTE:** Turn the master faders and monitor controls down to minimum when turning the phantom power on and off to avoid transient signals from entering your amplifier(s).

Applications: Basic Mono Operation:

This example shows how the mixer and one stereo power amplifier* may be used to run both the house speakers and the stage monitors.

Connect a signal cable between the mixer's Mono jack and the power amp's Channel 1 Input jack (A). Connect another signal cable between the mixer's Aux Out jack and the amp's Channel 2 Input jack (B). A graphic equalizer may be included in the signal chain as shown.

Connect a speaker cable between the power amp's Channel 1 Speaker Output and the house speakers (C). Connect another speaker cable between the amp's Channel 2 Speaker Output and the monitor speakers (D).

Use the mixer's Main L/R Fader to adjust the house volume level and the Aux controls to adjust the level of the mix going to the monitors.

*Two mono amplifiers may be used in place of the stereo power amplifier.

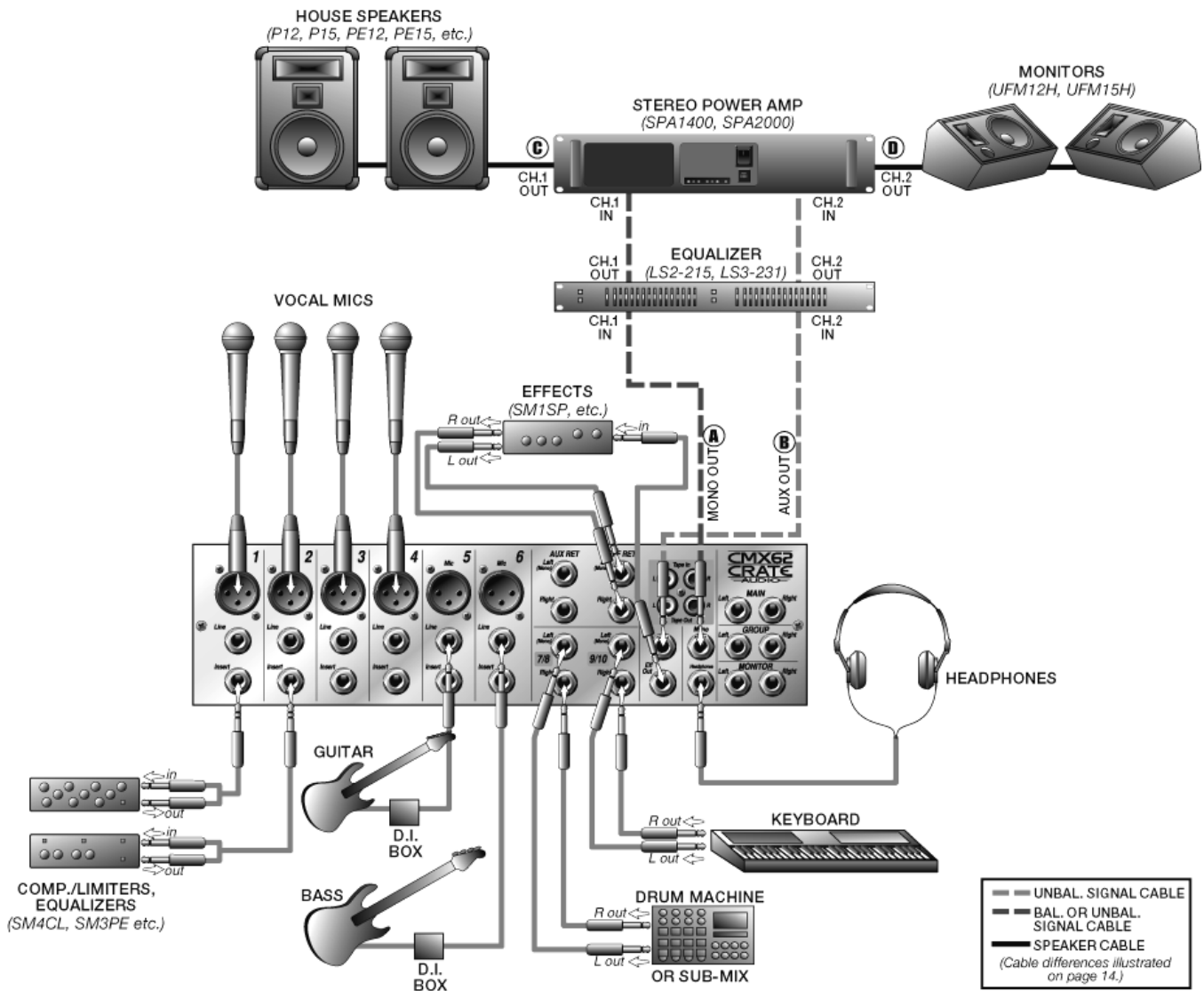

Please note that the sample connections shown in the Applications sections are NOT absolute mandates as to how to connect your sound system. They are merely intended to provide a springboard from which you may launch the system that will best suit your particular needs.

Applications: Home Studio:

In this example the Main L/R outputs are connected to a computer through a compressor. The Monitor outputs are connected to the monitor power amp which drives the studio monitors. The output of the computer may be connected to the stereo channel 9/10 of the mixer and the remaining audio sources may be connected to the various other inputs as shown. With this type of setup you will need to establish two different buses. Use the Main L/R bus to send a signal to the computer for recording and the Group 1/2 bus for signals to be monitored, but not recorded.

Start with all of the channel Grp/L/R switches set to GRP, the Group 1/2 AFL switch depressed, and the the Group to L/R switch in the out position. In this state you can play along with the computer, but not record (for practicing a take). Start the playback on the computer and play along with its output. When you are ready to record another instrument, set that instrument's channel Grp/L/R switch to L/R and depress its PFL switch. Now you can monitor both the Group (monitor) mix and the channel you wish to record without having any bleed between the two.

NOTE: You should set your computer software so that it does not send the signal it is recording back through the computer's audio outputs. If this is not done a slapback delay could result due to the latency of the computer.

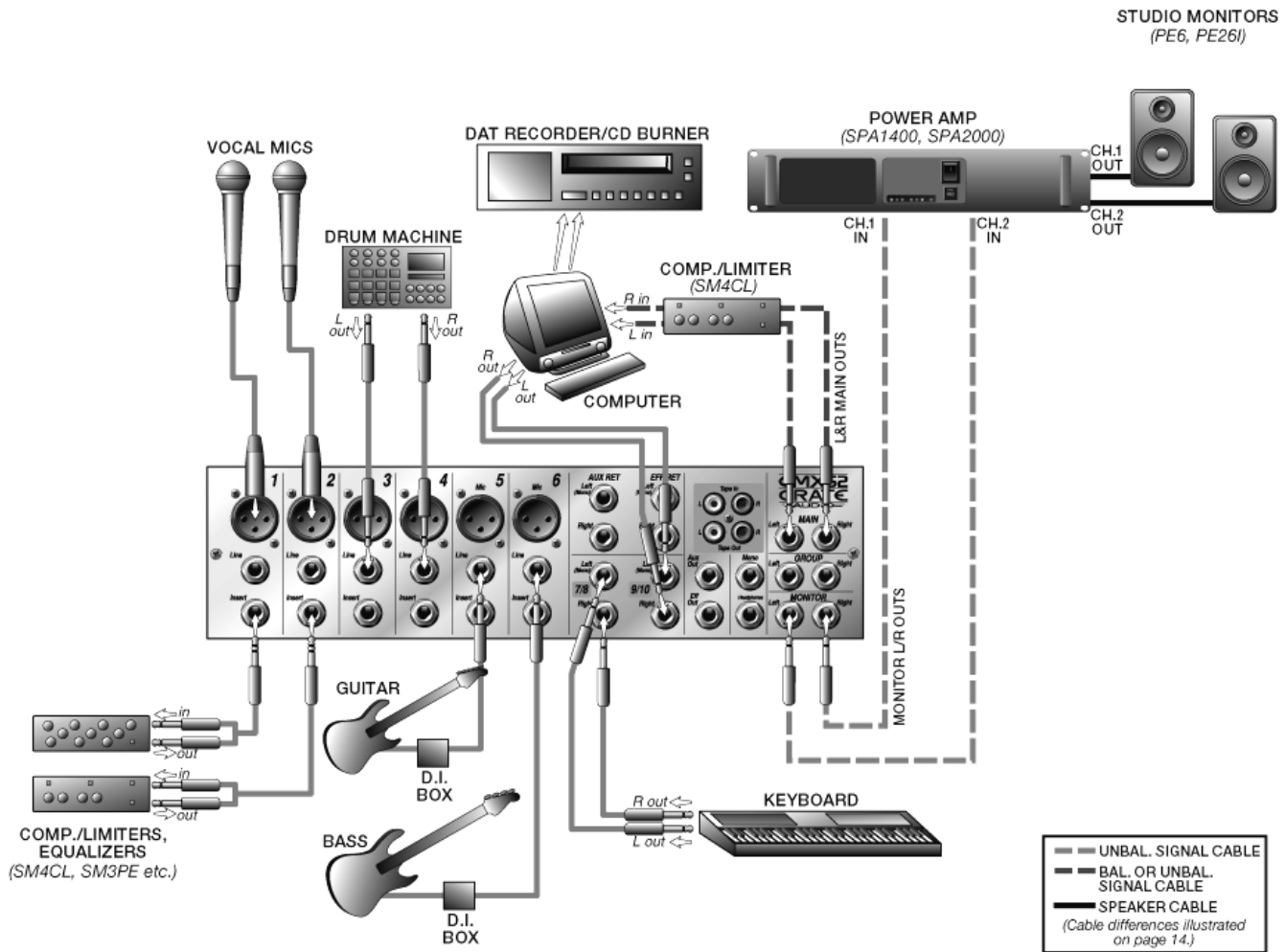

Applications: DJ Setup:

In this example the mixer is connected to a stereo power amplifier which drives the house speakers.

Connect a pair of signal cables between the mixer's Main Left and Right jacks and the stereo power amplifier's* Channel 1 and Channel 2 Input jacks (A).

Connect a speaker cable between the power amp's Channel 1 Speaker Output and one of the house speakers (B). Connect another speaker cable between the power amp's Channel 2 Speaker Output and the other house speaker (C).

Use the mixer's Main L/R fader to adjust the house volume level. (To keep the turntable signals in true stereo, the Pan pots for the left channels must be rotated fully counterclockwise and the Pan pots for the right channels must be rotated fully clockwise.

*Two matched mono amplifiers may be used in place of the stereo power amplifier.

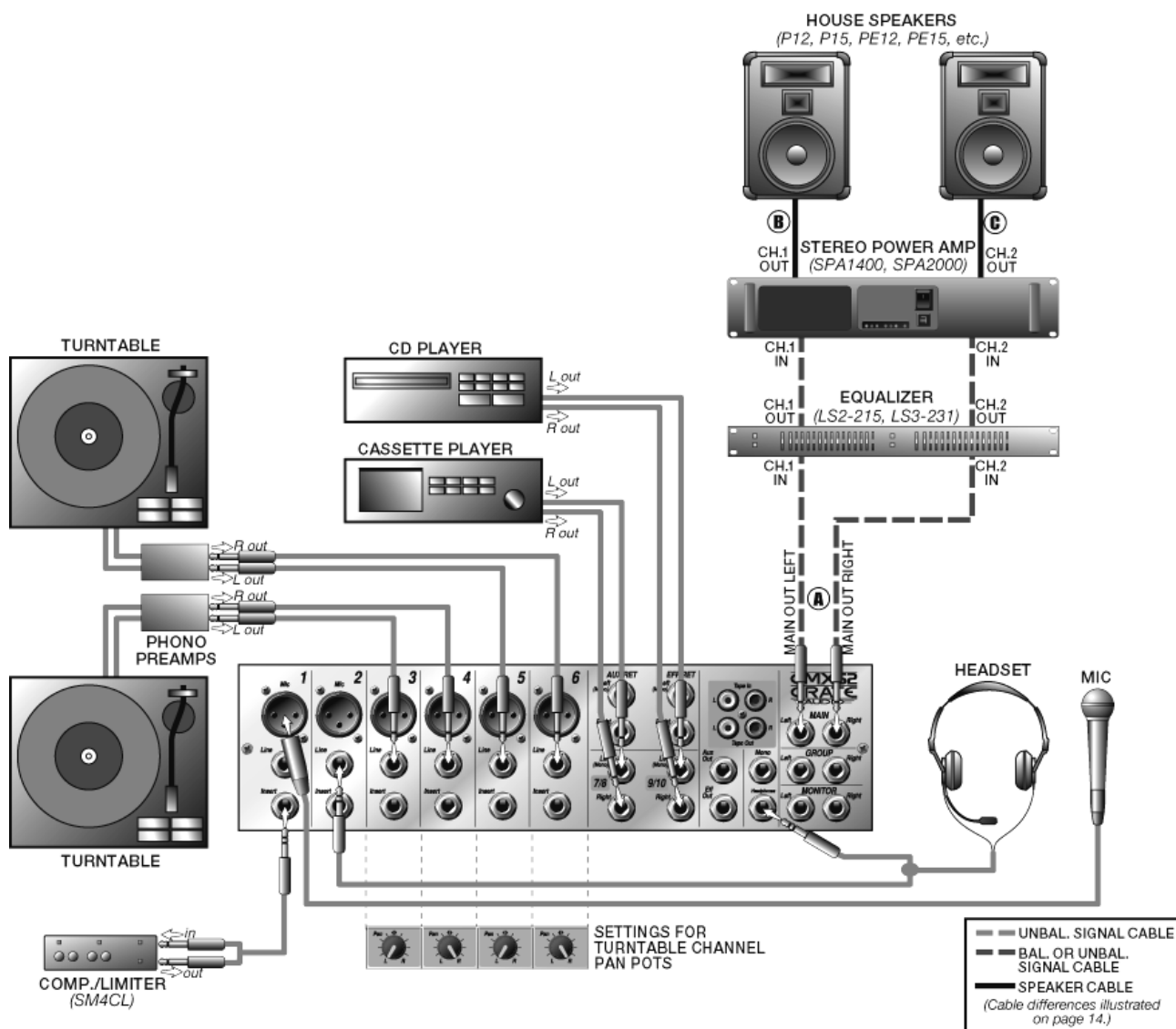

Applications: House of Worship:

In this example the mixer's Main Outs are used for the sanctuary mix, the Aux outs are used for a platform mix, and a mono signal is provided for the childcare room (or other remote location).

Connect signal cables between the mixer's Main Left and Right jacks and the Input jacks of the sanctuary speakers' stereo power amp* (A). Connect another set of signal cable between the mixer's Aux Out jack between the Input jack of the monitor speakers' power amp (B). Connect another signal cable between the mixer's Mono Out jack and a powered speaker system or an amplifier/speaker combination for the childcare room (C).

Connect speaker cables between the sanctuary power amp's Speaker Outputs and the sanctuary speakers (D,E). Connect another speaker cable between the monitor power amp's Speaker Output and the platform monitor speakers (E,F).

Use the Main L/R fader to adjust the level of the sanctuary speakers. Use the Aux controls to adjust the mix going to the platform monitors. Use the Mono control to adjust the level of the signal sent to any remote location (childcare room, etc.).

*Two matched mono amplifiers may be used in place of the stereo power amplifier.

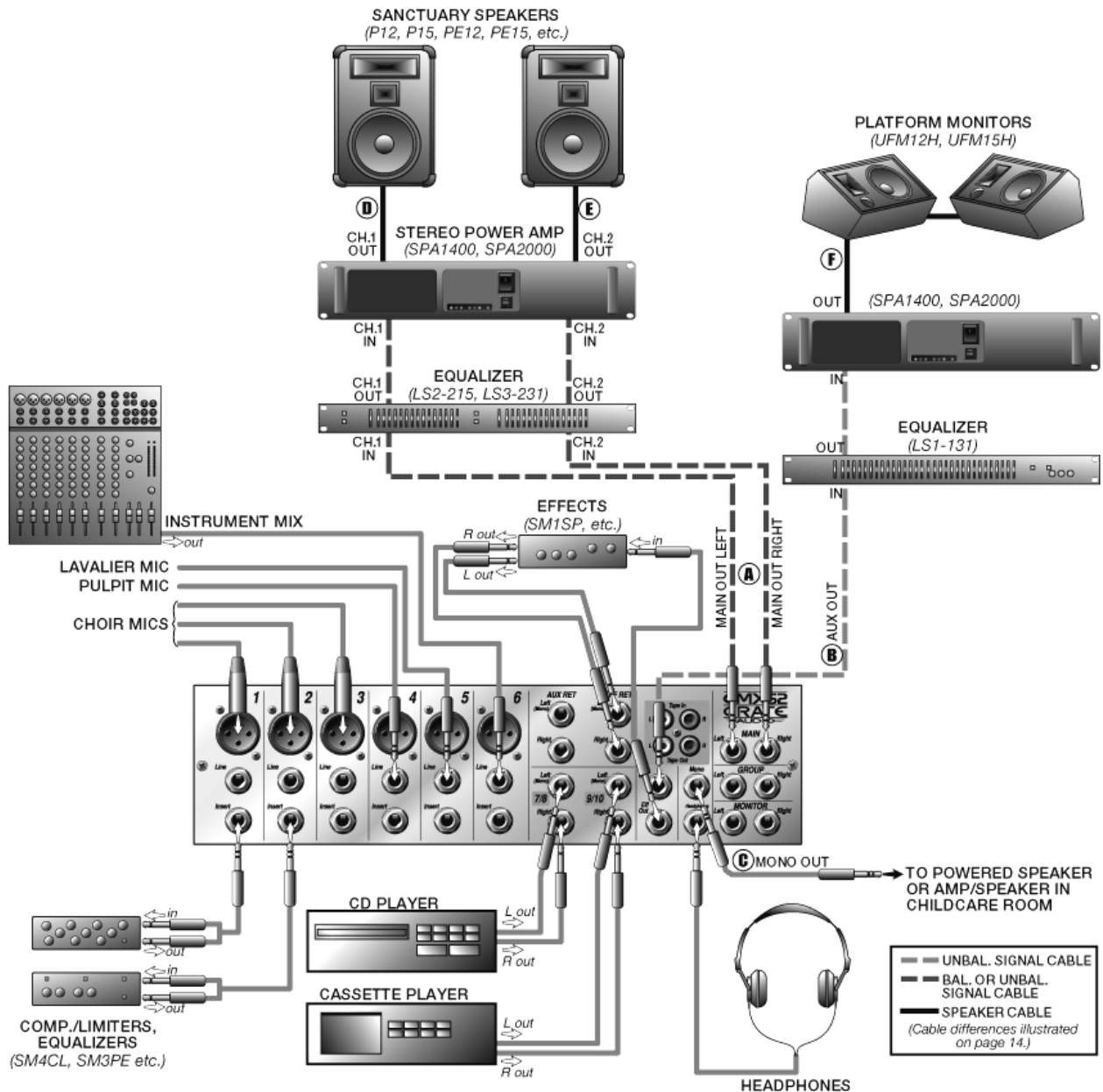

Applications: Separating Vocals and Instruments:

In this example the Pan controls on all of the vocal mic channels are rotated fully clockwise to assign all vocal mics to the right channel. The instrument channels are then all assigned to the left channel by rotating their Pan controls fully counter clockwise. Two pairs of speakers are required: one for the vocals and another for the instruments. An additional amplifier will drive the monitors. The vocal speakers should be placed on top of the instrument speakers to minimize interference between the sounds from the two sets of speakers.

Connect a pair of signal cables between the mixer's Main Left and Right jacks and the house power amp's Channel 1 and Channel 2 Input jacks (A). Connect a signal cable between the mixer's Aux Out jack and the monitor power amp's Input jack (B).

Connect a speaker cable between the stereo power amp's Channel 1 Speaker Output and the "instrument" speakers (C). Connect another speaker cable between the power amp's Channel 2 Speaker Output and the "vocal" speakers (D). Connect a third speaker cable between the monitor power amp's Speaker Output and the monitor speakers (E). Use the mixer's Main L/R fader to adjust the house volume level and the Aux controls to adjust the level of the mix going to the monitors.

Depress all of the vocal and instrument channels' Grp/L/R buttons. Depress the master Group to L/R button. Now you can use the Group 1 fader to control the instrument submix to the Main L/R fader and the Group 2 fader for the vocal submix.

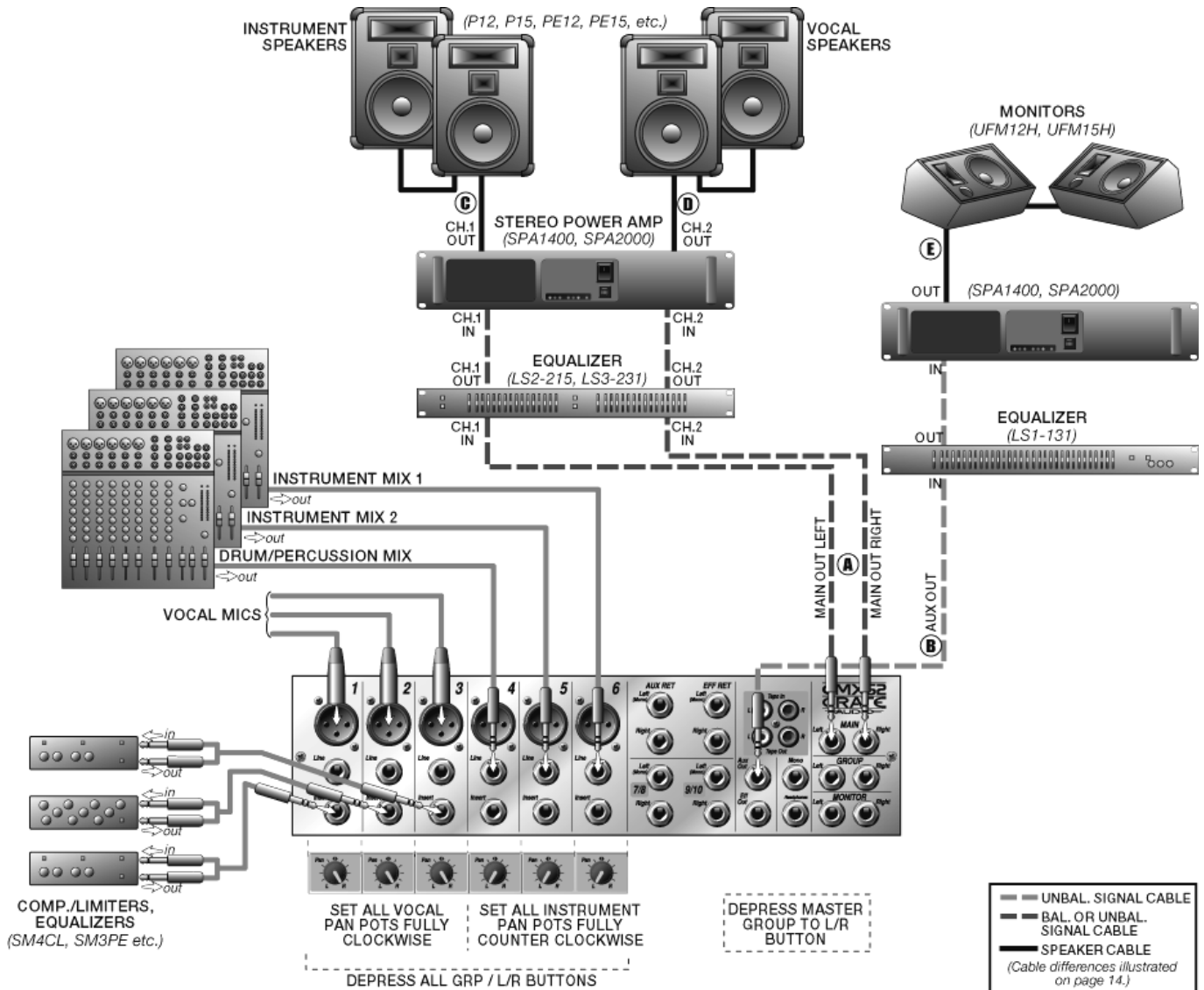

Applications: External Effects and Recorders:

There are several ways to use the CMX62 with external signal processors (such as effects and delay units, limiters, etc.). For example, any (or all) of the six mono channels may have its own processor patched in by use of the Insert jack (#3, page 4). Effects may also be patched in through the Aux or the Effects Out and Return jacks. Both the Aux and the Effects loops will accommodate stereo as well as mono effects. The illustrations below show some of the different connections.

The signal level for the Aux/Effect sends is controlled by the setting of each channel's Aux/Eff level controls. The Aux/Eff Rtn level controls (#43/45, page 6) let you control how much of the effected signal is in the master mix.

Connecting a tape deck for recording and playback is accomplished as follows: Connect the Playback (Line Out) of the deck to the mixer's Tape In jacks. Connect the Record (Line In) of the deck to the mixer's Tape Out jacks. The mixer's Tape In level control (#47, page 6) let you adjust the signal level from the tape deck. **To avoid feedback keep the Tape In control at minimum when recording!**

USING THE INSERT JACK (CHANNELS 1-6) WITH AN EFFECTS DEVICE'S INSERT JACK:

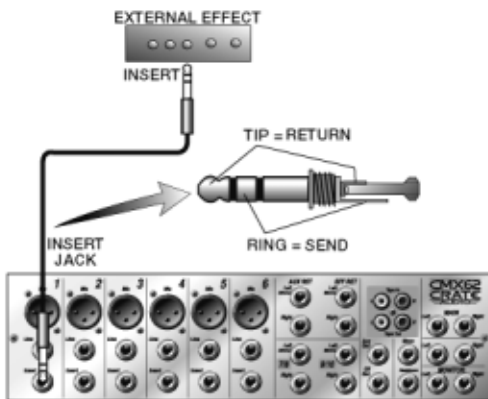

USING THE INSERT JACK (CHANNELS 1-6) WITH AN EFFECTS DEVICE'S INPUT/OUTPUT JACKS:

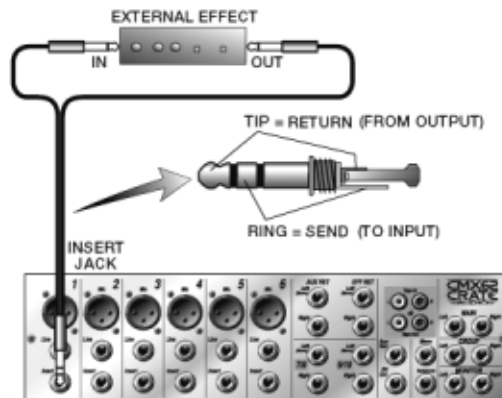

USING THE EFF OUT/EFF RTN JACKS (OR THE AUX OUT/AUX RTN JACKS) WITH AN EFFECT:

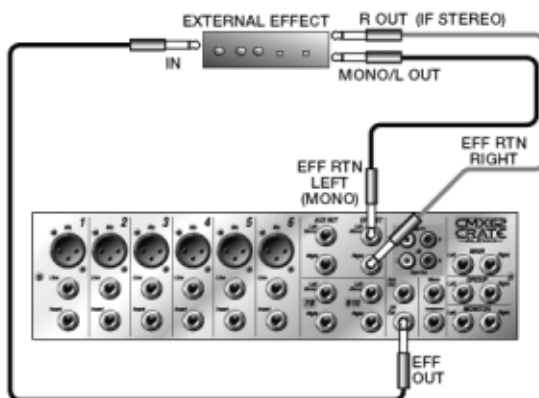

USING A TAPE DECK FOR RECORDING AND PLAYBACK:

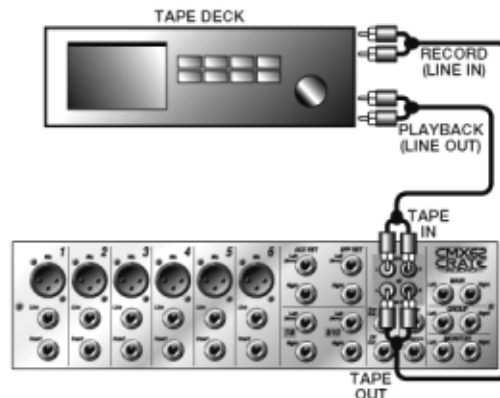

Equalization Diagrams:

Each input channel of the CMX62 has three bands of equalization which allows you to alter the tonal characteristics of the input signal. The EQs may be used to add "color" or to compensate for inadequacies of the original signal. They also may be used to cut frequencies which cause unnatural sounds or to de-emphasize over-pronounced tones and to reduce acoustic feedback. Each EQ has a range of 30dB (+/-15dB).

The high EQ for each channel is a "shelving" type, with an action point (+6dB) at 2.5kHz, reaching maximum effect at 12kHz and above.

The middle EQ for each channel is a "peaking" type, which affects frequencies from 300Hz to 2.5kHz, centered on 800Hz.

The low EQ for each channel is a "shelving" type with an action point (+6dB) at 300Hz, reaching maximum effect at 70Hz and below.

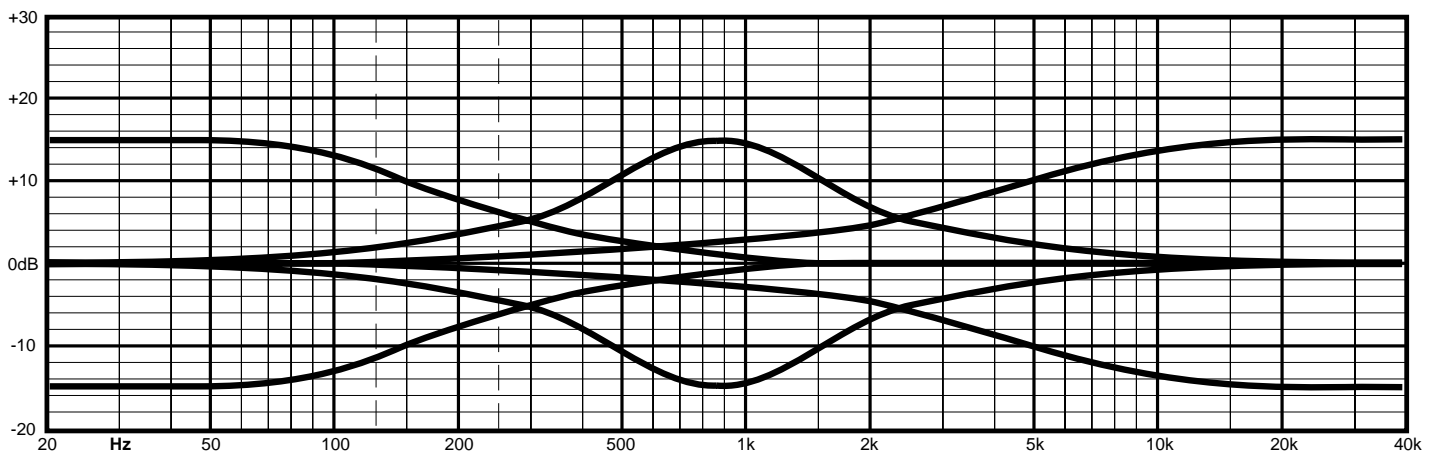

Differences in Cable Types:

This manual makes reference to different types of cables; in particular, balanced and unbalanced signal cables and speaker cables. These are not the only types of cables associated with sound reinforcement, but they are similar enough to each other to warrant a more descriptive explanation. The three 1/4"-terminated cables below may look alike at first, but upon closer examination their differences become apparent. These cables are illustrated below.

BALANCED SIGNAL CABLE:

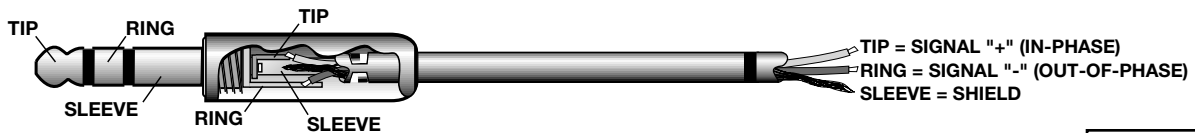

UNBALANCED SIGNAL CABLE:

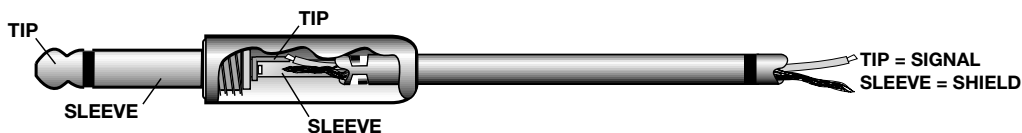

SPEAKER CABLE:

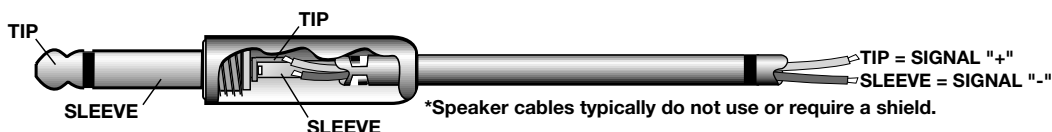

Care must be taken to avoid using SIGNAL cables in place of SPEAKER cables and vice-versa. Signal cables aren't made to handle the power which speaker cables do; speaker cables are not shielded and pick up external signals, resulting in excessive hum and buzzing.

System Block Diagram:

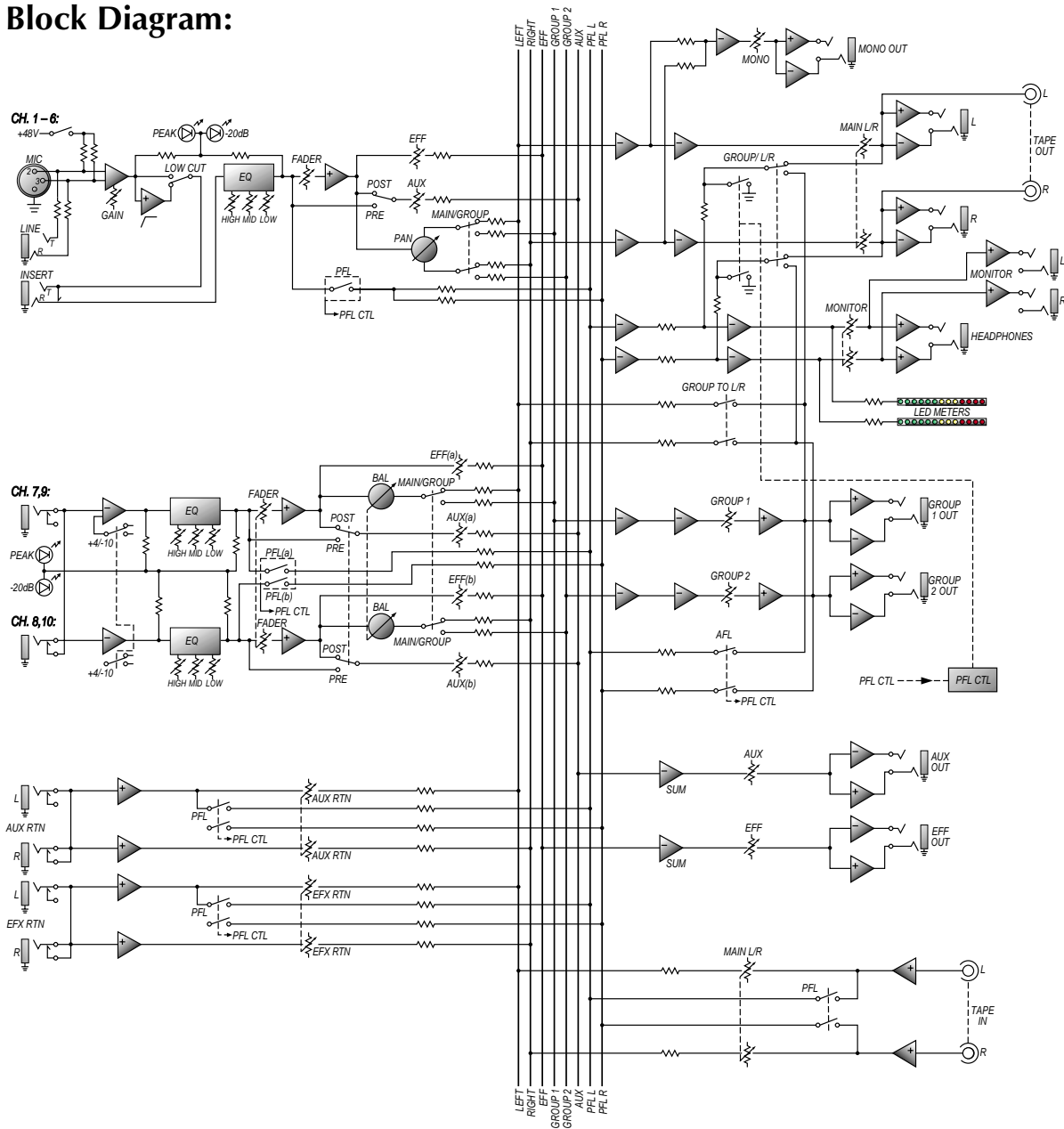

Gain Level Diagram:

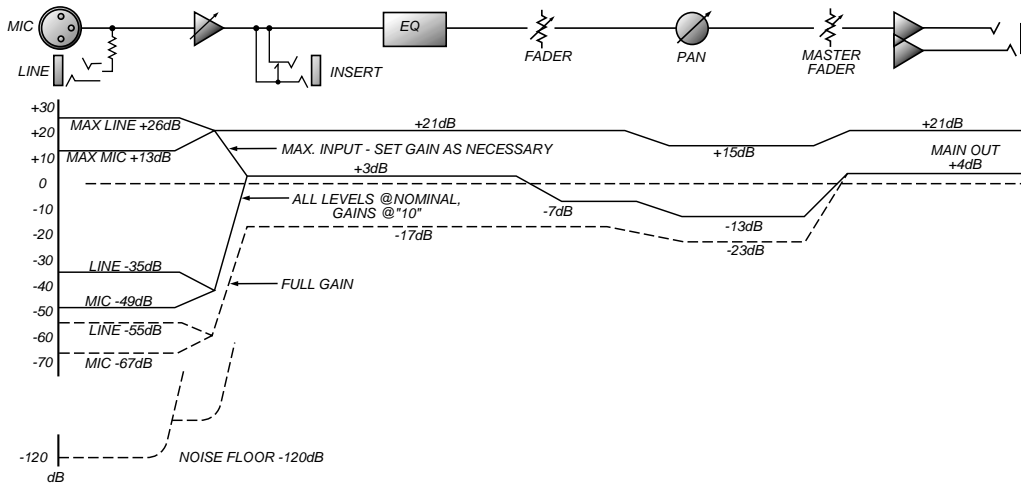

Technical Specifications**SYSTEM INPUTS**

6 mono mic/line and 2 stereo line input channels
1 stereo aux return
1 stereo effects return
1 stereo tape return

CHANNELS 1-6

Low-Z Mic 1 3-pin "XLR" (balanced, pin 2 = "in phase")
Transformerless electronically balanced
1k ohm load impedance
High-Z Line 1 1/4" phone jack (balanced)
10k ohm load impedance

CHANNELS 7-14

High-Z Line 2 1/4" phone jacks
22k ohm load impedance

EQUIVALENT INPUT NOISE

Typically < -129dB @ 20 - 20k equivalent bandwidth unweight-
ed with 200 ohm source impedance

COMMON MODE REJECTION

Typically -90dB min., -70dB @ 50Hz

SIGNAL INDICATOR

Indicates signal present (-20dB)

PEAK INDICATOR

Indicates 6dB headroom remaining

MAXIMUM SIGNAL ACCEPTED

Low-Z Mic 3.46V RMS (13dBv)
High-Z Line 15.9V RMS (26dBv)

CHANNEL GAIN

Typically 52dB adjustment range

CHANNEL INPUT SENSITIVITY

Low-Z Mic All levels up: 8.7mV RMS max. (43dB gain)
Channel up only: 2.7mV RMS max. (53dB gain)
All levels "+10": .28mV RMS max. (73dB gain)
High-Z Line All levels up: 87mV RMS max. (23dB gain)
Channel up only: 27mV RMS max. (33dB gain)
All levels "+10": 28mV RMS max. (53dB gain)

CHANNEL EQ (ACTIVE)

High +/-15dB @ 12kHz shelving
Mid +/-15dB @ 800Hz bandpass
Low +/-15dB @ 70Hz shelving

AUX/EFFECTS RETURNS / TAPE INPUTS

1/4" phone jacks 15k ohm input impedance
RCA jacks 15k ohm input impedance
Max. Sensitivity -20dBv (80mV RMS)
Max. Input Accepted +30dBv (24.5V RMS)

AUX/EFFECTS OUT / TAPE OUT

1/4" phone jacks +4dBv (1.23V RMS) @ High-Z nominal output
RCA jacks +4dBv (1.23V RMS) @ High-Z nominal output

PHANTOM POWER

+48VDC applied to pins 2 and 3 of XLR inputs

LEFT & RIGHT OUTPUTS

Unbalanced out @ 10k ohm load impedance
Balanced @ 3k ohm load impedance
+4dBv (1.23V RMS) nominal output
18dBv (6V RMS) max. output

DUAL OUTPUT LED INDICATORS

Type: 12 LED quasi-peak
Calibration: Calibrated to indicate +4dBv @ 7th LED
Range: -18dBv to +13dBv
Signals Read: Left and Right Main Outs or Solo Bus

RESIDUAL NOISE

90dB below 1.23V RMS min. with all levels down
60dB below 1.23V RMS with Master Level up full and one chan-
nel up full

TOTAL HARMONIC DISTORTION

< 0.1% @ 1kHz input @ 5V RMS output (typically 0.05%) meas-
ured from Mic In to Main Out (EQ flat) with Master @ nominal
"0" setting (-10dB from max. gain), and Gain and Channel Level
at max. (At lower input signal levels, measurement is limited by
the noise floor)

SIZE AND WEIGHT

2.75" H x 11.625" W x 13" D (70mm x 295mm x 330mm)
11 lbs (5 kg)

POWER REQUIREMENTS

16.8VAC x 2 @1A

*Due to ongoing product development and improvement, the specifications
contained herein are subject to change without notice.*



Free Manuals Download Website

<http://myh66.com>

<http://usermanuals.us>

<http://www.somanuals.com>

<http://www.4manuals.cc>

<http://www.manual-lib.com>

<http://www.404manual.com>

<http://www.luxmanual.com>

<http://aubethermostatmanual.com>

Golf course search by state

<http://golfingnear.com>

Email search by domain

<http://emailbydomain.com>

Auto manuals search

<http://auto.somanuals.com>

TV manuals search

<http://tv.somanuals.com>