

# CRATE

## **VTX350H** **Three-Channel Guitar Amplifier** **with Advanced Digital Signal** **Processing**



## **User's Guide**

**TABLE OF CONTENTS:**

Introduction .....3  
The Front Panel .....4,5  
The Rear Panel .....6  
The DSP Section .....7  
Storing Your Own Presets .....8  
Restoring the Factory Presets .....8  
More About The Save/Tap Button .....8  
Using the Footswitch .....9  
DSP Factory Presets .....10,11  
Suggested Settings .....12,13  
DSP “Fill in the Blanks” (for User Presets) .....14  
System Block Diagram .....15  
Technical Specifications .....back cover

This equipment has been tested and found to comply with the limits for a Class B digital device, pursuant to part 15 of the FCC Rules. These limits are designed to provide reasonable protection against harmful interference in a residential installation. This equipment generates, uses and can radiate radio frequency energy and, if not installed and used in accordance with the instructions, may cause harmful interference to radio communications. However, there is no guarantee that interference will not occur in a particular installation. If this equipment does cause harmful interference to radio or television reception, which can be determined by turning the equipment off and on, the user is encouraged to try to correct the interference by one or more of the following measures:

- Reorient or relocate the receiving antenna.
- Increase the separation between the equipment and the receiver.
- Connect the equipment into an outlet on a circuit different from that to which the receiver is connected.
- Consult the dealer or an experienced radio/TV technician for help.

Changes or modifications to this device not expressly approved by SLM Electronics could void the user’s authority to operate the equipment under FCC rules.

**Declaration of Conformity**

**Manufacturer’s Name:** SLM Electronics  
**Corporate Headquarters:** 1901 Congressional Drive, St. Louis, Missouri 63146  
**Primary Production Facility:** 700 Hwy 202 W, Yellville, Arkansas, 72687

**Product Type:** Audio Amplifier

**Products meet the regulations for compliance marking under:**

ETL standards UL6500, UL60065, or UL813  
CSA standards E60065 or C22.2 No.1-M90  
CE safety standard EN60065  
CE EMC standards EN55103 or EN55013 and EN61000  
C-tick designation Level 2, ABN #56748810738, ARBN# N222  
KETI standard K60065 (limited model approval)

Compliance Support Contact: SLM Electronics, Attn: R&D Compliance Engineer  
1901 Congressional Drive, St Louis, Missouri, 63146 • Tel.: 314-569-0141, Fax: 314-569-0175

**Congratulations!**

You are now the proud owner of the Crate VTX350H three-channel guitar amplifier with Advanced Digital Signal Processing. This rugged amplifier combines outstanding features with serious clean and distorted sounds. Dual DSP controls provide 15 modulation effects and 15 delay effects which can be combined for a wide variety of sounds. The Tap/Save button allows you to manually set the tempo of many of the effects and to save new DSP presets in the amplifier's non-volatile memory. A separate Reverb control adds even more to the array of effects.

A highly visible electronic tuner (with a Mute switch for silent tuning) allows you to get tuned and stay in tune any time the amplifier is on. The rear panel Line In and Line Out jacks allow you to connect additional equipment for even greater flexibility.

Channel switching, Tap/Save, and a second bank of DSP effects may be controlled by means of the supplied four button footswitch.

Like all Crate products, your VTX350H amplifier is designed by musicians, and built using only the best components. Extensive testing confirms that this amplifier is the absolute best it can be.

In order to get the most out of your new amplifier, we strongly suggest that you read the information contained in this guide before you begin playing.

And **thank you** for choosing Crate.

 <b>CAUTION</b> RISK OF ELECTRIC SHOCK DO NOT OPEN 	 <b>PRECAUCION</b> RIESGO DE CORRIENTAZO NO ABRA 	 <b>ATTENTION</b> RISQUE D'ELECTROCUTION NE PAS OUVRIIR 
WARNING: TO REDUCE THE RISK OF FIRE OR ELECTRIC SHOCK, DO NOT EXPOSE THIS APPARATUS TO RAIN OR MOISTURE. TO REDUCE THE RISK OF ELECTRIC SHOCK, DO NOT REMOVE COVER. NO USER-SERVICEABLE PARTS INSIDE. REFER SERVICING TO QUALIFIED SERVICE PERSONNEL.	PRECAUCION: PARA REDUCIR EL RIESGO DE INCENDIOS O DESCARGAS ELECTRICAS, NO PERMITA QUE ESTE APARATO QUEDE EXPUESTO A LA LLUVIA O LA HUMEDAD. PARA DISMINUIR EL RIESGO DE CORRIENTAZO, NO ABRA LA CUBIERTA. NO HAY PIEZAS ADENTRO QUE EL USUARIO PUEDE REPARAR DEJE TODO MANTENIMIENTO A LOS TECNICOS CALIFICADOS.	ATTENTION: PROTEGEZ CET APPAREIL DE LA PLUIE ET DE L'HUMIDITE AFIN D'EVITER TOUT RISQUE D'INCENDIE OU D'ELECTROCUTION. POUR REDUIRE D'ELECTROCUTION NE PAS ENLEVER LE COUVERCLE. AUCUNE PIECE INTERNE N'EST REPARABLE PAR L'UTILISATEUR. POUR TOUTE REPARATION, S'ADRESSER A UN TECHNICIEN QUALIFIE.
<b>IMPORTANT SAFETY INSTRUCTIONS</b>		
<ul style="list-style-type: none"> <li>• READ, FOLLOW, HEED, AND KEEP ALL INSTRUCTIONS AND WARNINGS.</li> <li>• DO NOT OPERATE NEAR ANY HEAT SOURCE AND DO NOT BLOCK ANY VENTILATION OPENINGS ON THIS APPARATUS. FOR PROPER OPERATION, THIS UNIT REQUIRES 3" (75mm) OF WELL VENTILATED SPACE AROUND HEATSINKS AND OTHER AIR FLOW PROVISIONS IN THE CABINET.</li> <li>• DO NOT USE THIS APPARATUS NEAR SPLASHING, FALLING, SPRAYING, OR STANDING LIQUIDS.</li> <li>• CLEAN ONLY WITH LINT-FREE DAMP CLOTH AND DO NOT USE CLEANING AGENTS.</li> <li>• ONLY CONNECT POWER CORD TO A POLARIZED, SAFETY GROUNDED OUTLET WIRED TO CURRENT ELECTRICAL CODES AND COMPATIBLE WITH VOLTAGE, POWER, AND FREQUENCY REQUIREMENTS STATED ON THE REAR PANEL OF THE APPARATUS.</li> <li>• PROTECT THE POWER CORD FROM DAMAGE DUE TO BEING WALKED ON, PINCHED, OR STRAINED.</li> <li>• UNPLUG THE APPARATUS DURING LIGHTNING STORMS OR WHEN UNUSED FOR LONG PERIODS OF TIME.</li> <li>• ONLY USE ATTACHMENTS, ACCESSORIES, STANDS, OR BRACKETS SPECIFIED BY THE MANUFACTURER FOR SAFE OPERATION AND TO AVOID INJURY.</li> <li>• WARNING: TO REDUCE THE RISK OF ELECTRIC SHOCK OR FIRE, DO NOT EXPOSE THIS UNIT TO RAIN OR MOISTURE.</li> <li>• SERVICE MUST BE PERFORMED BY QUALIFIED PERSONNEL.</li> <li>• OUR AMPLIFIERS ARE CAPABLE OF PRODUCING HIGH SOUND PRESSURE LEVELS. CONTINUED EXPOSURE TO HIGH SOUND PRESSURE LEVELS CAN CAUSE PERMANENT HEARING IMPAIRMENT OR LOSS. USER CAUTION IS ADVISED AND EAR PROTECTION IS RECOMMENDED IF UNIT IS OPERATED AT HIGH VOLUME.</li> <li>• WARNING: THIS UNIT REQUIRES A SAFETY GROUNDED OUTLET WIRED TO CURRENT ELECTRIC CODES HAVING THE LINE SUPPLY VOLTAGE, POWER, AND FREQUENCY IDENTIFIED ON THE REAR OF THE UNIT. THE OUTLET MUST REMAIN ACCESSIBLE TO DISCONNECT THE UNIT IF A FAULT SHOULD ARISE WHILE IN USE. THIS UNIT SHOULD BE UNPLUGGED WHEN NOT IN USE.</li> </ul>		
EXPLANATION OF GRAPHICAL SYMBOLS: EXPLICACION DE SIMBOLOS GRAFICOS: EXPLICATION DES SYMBOLES GRAPHIQUES:	= "DANGEROUS VOLTAGE" "VOLTAJE PELIGROSO" "DANGER HAUTE TENSION"	= "IT IS NECESSARY FOR THE USER TO REFER TO THE INSTRUCTION MANUAL" "ES NECESARIO QUE EL USUARIO SE REFERIA AL MANUAL DE INSTRUCCIONES." "REFERREZ-VOUS AU MANUAL D'UTILISATION"



**The Front Panel:**

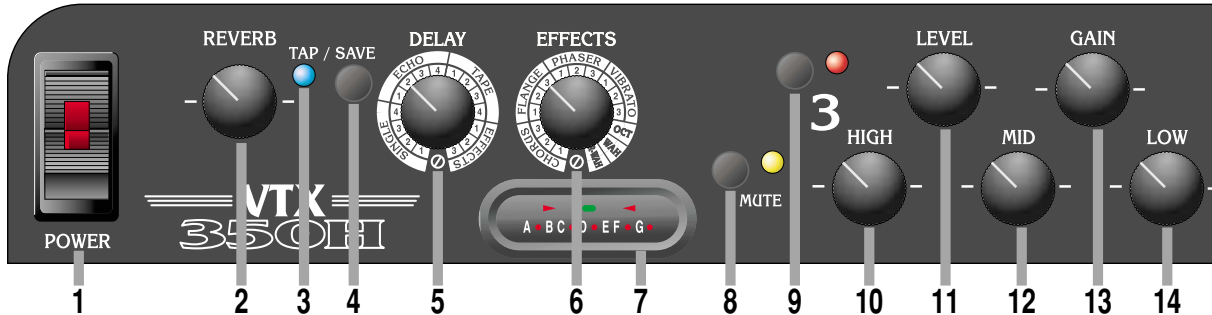

**1. POWER:** Use this switch to turn the amplifier on (top of the switch depressed) and off (bottom of the switch depressed). The switch illuminates when the power is on.

**2. REVERB:** Use this control to adjust the amount of digital reverb effect. In its fully counterclockwise position the signal will be “dry” (without any reverb). As you rotate the control clockwise the amount of reverb increases.

**3. TAP/SAVE (LED):** This LED flashes in time with the tempo set by the Tap/Save button (#4), and serves as a status indicator for certain DSP activities (see page 8).

*NOTE: For some of the DSP effects, the Save/Tap LED remains illuminated. The Save/Tap LED does not illuminate when the DSP knobs are set to the Bypass position.*

**4. TAP/SAVE:** Use this pushbutton to set the tempo of many of the effects by tapping the button repeatedly in time with the desired tempo. The Tap/Save button is also used to save DSP presets and to restore the factory default DSP settings. Additional information about the Tap/Save button is on pages 7 and 8.

**5. DELAY:** Use this control to select one of the fifteen digital delay effects. Complete information about the DSP effects is on page 7.

**6. EFFECTS:** Use this control to select one of the fifteen digital modulation effects. Complete information about the DSP effects is on page 7.

**7. (ELECTRONIC TUNER):** The electronic tuner is active whenever the amplifier is turned on, providing constant, “real-time” tuning. The bottom row of LEDs indicate which note (string) is being tuned. The top row of LEDs provides directional queues to facilitate quick and precise tuning of your instrument. The indicated note (string) is properly tuned when only the center LED is illuminated.

**8. MUTE:** This switch, when depressed, mutes the output signals at the Speaker jacks (#30) and the Line out jack (#28), allowing you to silently tune or switch instruments. The adjacent yellow LED illuminates when the Mute function is active.

**9. 3 (CH 3 SELECT):** This switch, when depressed, selects Channel 3 as the active channel. The adjacent red LED illuminates when Channel 3 is active. Channel 3 features a high gain FlexWave circuit for extreme distortion and sustain.

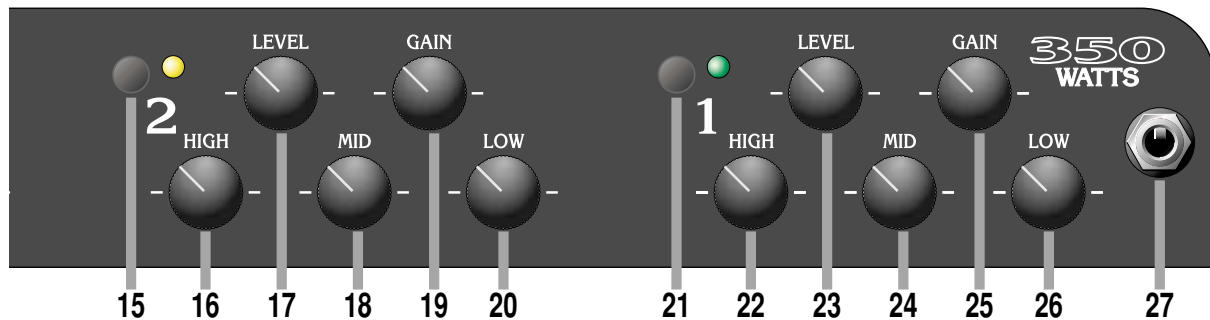

- 10. HIGH:** Use this control to adjust the high frequency level of Channel 3.
- 11. LEVEL:** Use this control to adjust the output level of Channel 3.
- 12. MID:** Use this control to adjust the midrange frequency level of Channel 3.
- 13. GAIN:** Use this control to adjust the amount of distortion produced by Channel 3.
- 14. LOW:** Use this control to adjust the low frequency level of Channel 3.
- 15. 2 (CH 2 SELECT):** This switch, when depressed, selects Channel 2 as the active channel. The adjacent yellow LED illuminates when Channel 2 is active. Channel 2 features a medium gain FlexWave circuit for moderate distortion and “crunch.”
- 16. HIGH:** Use this control to adjust the high frequency level of Channel 2.
- 17. LEVEL:** Use this control to adjust the output level of Channel 2.
- 18. MID:** Use this control to adjust the midrange frequency level of Channel 2.
- 19. GAIN:** Use this control to adjust the amount of distortion produced by Channel 2.
- 20. LOW:** Use this control to adjust the low frequency level of Channel 2.
- 21. 1 (CH 1 SELECT):** This switch, when depressed, selects Channel 1 as the active channel. The adjacent green LED illuminates when Channel 1 is active. Channel 1 features a low gain FlexWave circuit for clean sounds or sounds with mild distortion.
- 22. HIGH:** Use this control to adjust the high frequency level of Channel 1.
- 23. LEVEL:** Use this control to adjust the output level of Channel 1.
- 24. MID:** Use this control to adjust the midrange frequency level of Channel 1.
- 25. GAIN:** Use this control to adjust the amount of distortion produced by Channel 1.
- 26. LOW:** Use this control to adjust the low frequency level of Channel 1.
- 27. (INPUT):** Use this jack to connect your guitar to the amplifier by means of a shielded instrument cable.

**The Rear Panel:**

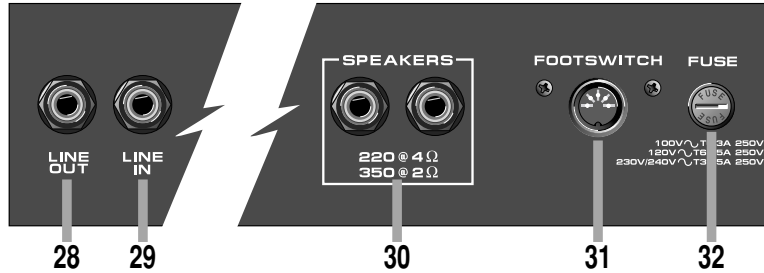

**28. LINE OUT:** When using an external effects processor, connect this jack to the input of the effect by means of a shielded signal cable. This jack also doubles as a source for a post-EQ preamp signal to send to a mixing board, recorder, powered monitor or external amplifier.

**29. LINE IN:** When using an external effects processor, connect this jack to the output of the effect by means of a shielded signal cable. This jack also doubles as a direct connection to the power amp, bypassing the input and pre-amp stages. This is useful for “slaving” a pair of amplifiers together.

**30. SPEAKERS:** Use these jacks to connect the amplifier to your speaker(s) by means of speaker cables with mono 1/4” plugs. These jacks are wired in parallel. Make sure that the combined impedance of your speakers is equal to or greater than 2 ohms! Use the chart below to help determine parallel loads. If in doubt, ask your dealer.

CAB IMP	# CABS	TOTAL IMP	CAB IMP	# CABS	TOTAL IMP
4 ohms	2	2 ohms	16 ohms	2	8 ohms
8 ohms	2	4 ohms	16 ohms	4	4 ohms
8 ohms	4	2 ohms	16 ohms	8	2 ohms

**31. FOOTSWITCH:** Use this jack to connect the footswitch cable (5-conductor midi cable) to the four button footswitch (supplied). This allows you to remotely switch between the channels, set tap tempos, save new presets, and access a second set of DSP presets. (See page 9 for additional information.)

**32. FUSE:** The fuse protects the amplifier from damages caused by a faulty AC power source and/or other problems. If the fuse opens, replace it ONLY with the same size and type. If fuses continue to fail, check the AC source – if the source is okay, contact your Crate dealer for service information.

**33. AC LINE CORD (not shown):** This grounded power cord is to be plugged into a grounded power outlet, wired to current electrical codes and compatible with the voltage, power, and frequency requirements stated on the rear panel. **Do not attempt to defeat the safety ground connection.**

**WARNING:** *The speaker output of this unit can exceed 10 Watts and could be a shock injury. Connection to speakers should be performed by a skilled person in compliance with local building codes. Class 2 wiring is required for speaker cables. Use of external speakers outside the ratings stated at the speaker jack may result in a shock injury or damage to the unit.*

# CRATE VTX350H Three-Channel Guitar Amplifier with Advanced DSP

## The DSP Section:

The VTX350H features DSP controls for Reverb, Delay and Effects. Complete information about the modulated and delay effects is given below. The Delay control selects the delay or echo effects.

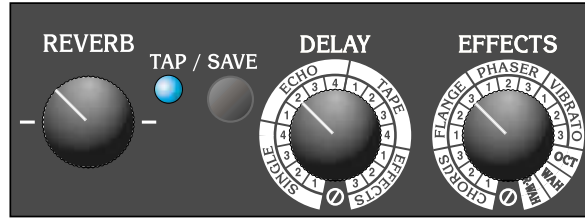

All of these effects have their speed controlled by the Tap/Save button. The Effects control selects the “pitch modified” and wah effects. Many of these effects have their speed controlled by the Tap/Save button. Additional information is provided on pages 5 and 10.

SIGNAL PATH FOR DELAY "EFFECTS 1, 2 & 3"

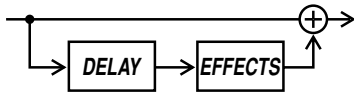

SIGNAL PATH FOR ALL OTHER EFFECTS COMBINATIONS

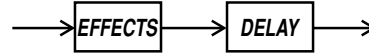

### DELAY:

NAME	DESCRIPTION	SAVE/TAP BUTTON CONTROLS:
Single 1	Single delay w/low level	time: .05–1 second
Single 2	Single delay w/medium level	time: .05–1 second
Single 3	Single delay w/high level	time: .05–1 second
Single 4	Single delay w/maximum level	time: .05–1 second
Echo 1	Echo w/low level	time: .05–1 second
Echo 2	Echo w/medium level	time: .05–1 second
Echo 3	Echo w/high level	time: .05–1 second
Echo 4	Echo w/maximum level	time: .05–1 second
Tape 1	Tape echo w/low level	time: .05–1 second
Tape 2	Tape echo w/medium level	time: .05–1 second
Tape 3	Tape echo w/high level	time: .05–1 second
Tape 4	Tape echo w/maximum level	time: .05–1 second
Effects 1	Echo w/low level, before effect	time: .05–1 second
Effects 2	Echo w/medium level, before effect	time: .05–1 second
Effects 3	Echo w/high level, before effect	time: .05–1 second
∅	Bypass - no effect	n/a

### EFFECTS:

NAME	DESCRIPTION	SAVE/TAP BUTTON CONTROLS:
Chorus 1	Chorus w/low depth	speed: 1 cycle/tap - tap period: .05–1 second
Chorus 2	Chorus w/medium depth	speed: 1 cycle/tap - tap period: .05–1 second
Chorus 3	Chorus w/high depth	speed: 1 cycle/tap - tap period: .05–1 second
Flange 1	Flanger w/low depth	speed: 4 cycle/tap - tap period: .05–1 second
Flange 2	Flanger w/medium depth	speed: 4 cycle/tap - tap period: .05–1 second
Flange 3	Flanger w/high depth	speed: 4 cycle/tap - tap period: .05–1 second
Phaser 1	Phaser w/low feedback	speed: 2 cycle/tap - tap period: .05–1 second
Phaser 2	Phaser w/medium feedback	speed: 2 cycle/tap - tap period: .05–1 second
Phaser 3	Phaser w/high feedback	speed: 2 cycle/tap - tap period: .05–1 second
Vibrato 1	Vibrato w/low depth	speed: 1 cycle/tap - tap period: .05–1 second
Vibrato 2	Vibrato w/medium depth	speed: 1 cycle/tap - tap period: .05–1 second
Vibrato 3	Vibrato w/high depth	speed: 1 cycle/tap - tap period: .05–1 second
Oct	Adds signal one octave lower	n/a
Wah	Touch-sensitive wah-wah	n/a
R-Wah	Inverted wah-wah	n/a
∅	Bypass - no effect	n/a

## Storing Your Own Presets:

Each channel of the VTX350H has two factory assigned Effects presets, as shown on pages 10 and 11. No matter what the settings of the Reverb, Delay and Effects controls, the DSP and reverb presets are recalled when a channel is selected. You may change the DSP and reverb settings by rotating the Reverb, Delay and Effects controls - these changes will remain active until a different channel is selected, but will not be there for later use unless they are saved. To save a new preset to a channel, first make the desired changes. Then press and hold the Tap/Save button for about three seconds. The Tap/Save LED will flash through three quick sequences, indicating the preset was saved. The new preset is stored for that channel and will remain in memory until a new preset is stored for that channel or the factory presets are restored.

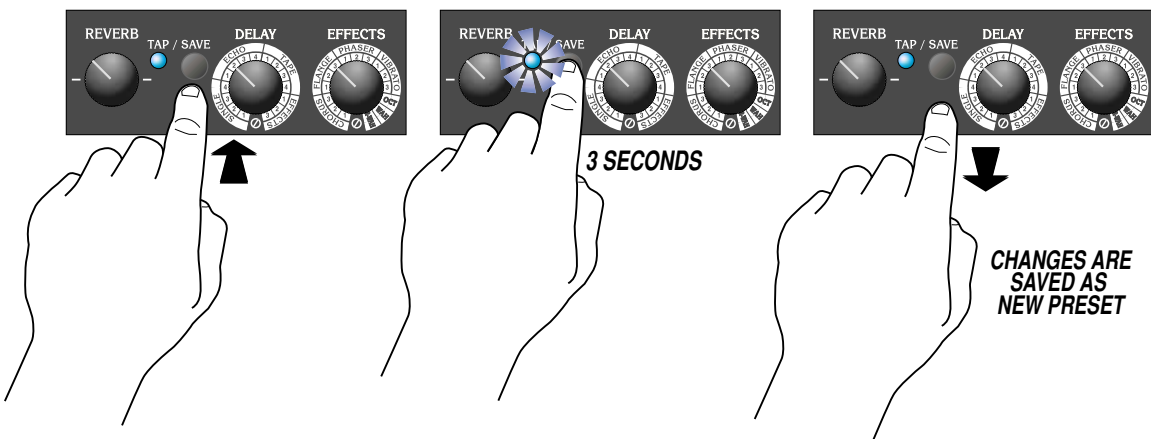

*(We recommend making copies of page 14 of this guide for the purpose of writing down your own presets.)*

## Restoring the Factory Presets:

The factory assigned presets may be restored, erasing any changes you have made. Turn the amplifier off. Press and hold the Tap/Save button as you turn the amplifier on. The Tap/Save LED will flash through two quick sequences, indicating the factory presets have been restored.

## More About the Tap/Save Button:

The Tap/Save button is used to set the tempo of an effect simply by tapping on it in time to the desired tempo – the time between the two taps sets the timing of the effect. (If the tempo entered is greater than one tap per second, the tempo will default to one second, which is the maximum tap-tempo time period.)

The Delay and the Effects may each have a different tap speed. The default “target” for the Tap/Save button is the Delay control. To select the Effects control as the tap button’s target, rotate the Effects control. The Tap/Save tempo function will automatically revert back to the Delay control 16 seconds after the Effects control is rotated, or when the tap speed was last changed for the effect. (If the Delay control is set to Bypass, the Tap/Save function will not revert to Delay.)

**NOTE:** *In most cases, it is usually more pleasing to the ear to set a slower tap speed for the high level effects and a faster tap speed for the low level effects - see page 7.*



**Using the Footswitch:**

The special Crate four button footswitch supplied with the VTX350H performs a variety of functions. The footswitch allows remote channel selection, remote Tap/Save for each channel, and allows access to an additional DSP preset for each channel of the amplifier. Use only the supplied Crate four button footswitch with the VTX350H. A standard 5-wire midi cable (supplied) may be used to connect the footswitch to the amplifier.

When the footswitch is connected to the amplifier, the first tap of buttons 1 - 3 select the corresponding channel. Once a channel is selected, consequent taps of the same buttons produce the same results as tapping the front panel Tap/Save button – you can use the footswitch to store presets and set the tempo of an effect. (See page 8.)

The “original” DSP presets are active for each channel when the #4 footswitch LED is illuminated. These are referred to as “DSP Bank ‘A.’” When the #4 button is switched and the LED is off, a second DSP preset may be stored and recalled for each channel - “DSP Bank ‘B’.”

**VTX350H REAR PANEL**

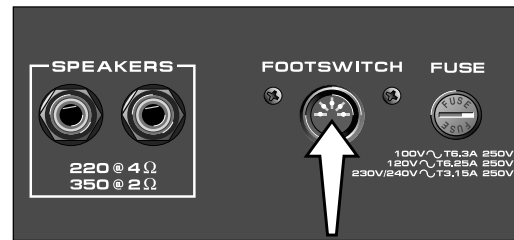

*5-Conductor MIDI cable*

**FOOTSWITCH**

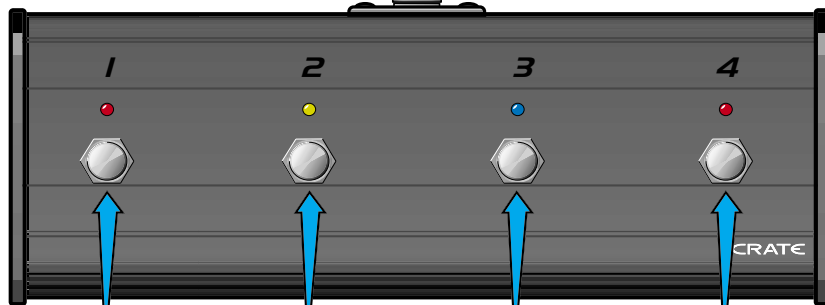

**NOTE:** DSP Bank “B” presets are only accessible when the footswitch is connected to the amplifier. When the footswitch is not connected, only DSP Bank “A” is accessible.

- SWITCH #1:  
CH. 1 SELECT;  
TAP/SAVE FOR CH. 1
- SWITCH #2:  
CH. 2 SELECT;  
TAP/SAVE FOR CH. 2
- SWITCH #3:  
CH. 3 SELECT;  
TAP/SAVE FOR CH. 3
- SWITCH #4:  
LED on: DSP BANK A  
LED off: DSP BANK B

**DSP Factory Presets:**

The VTX350H Factory Presets for the DSP section are as follows:

**Factory Preset 1: Clean w/Chorus, Delay, Reverb**

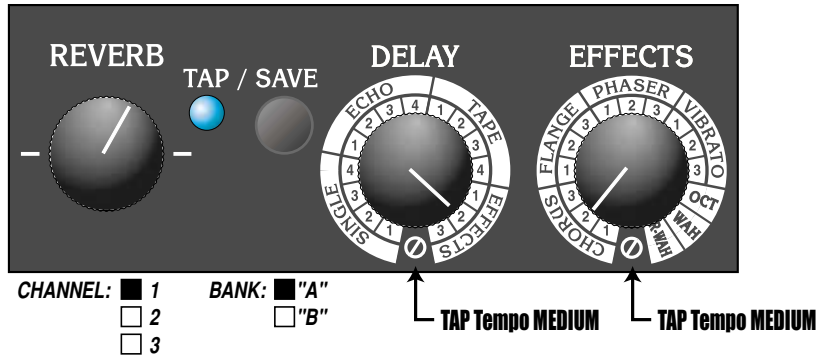

**Factory Preset 2: Rhythm w/Slapback Delay**

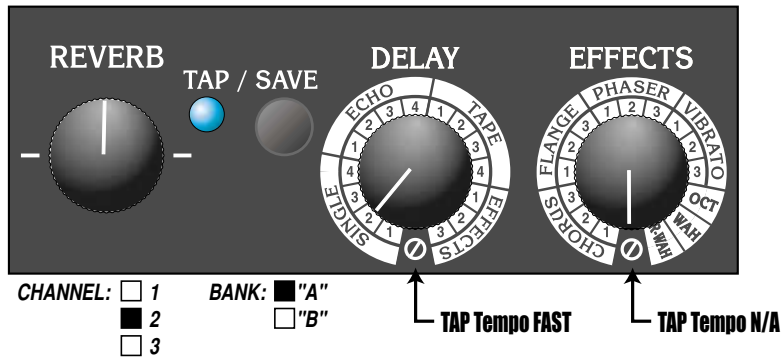

**Factory Preset 3: Solo w/Flange, Delay, Reverb**

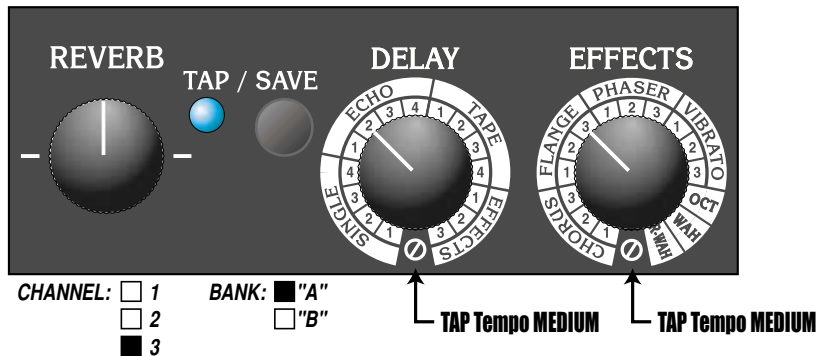

**DSP Factory Presets:**

The VTX350H Factory Presets for the DSP section are as follows:

**Factory Preset 4: Clean w/Reverb**

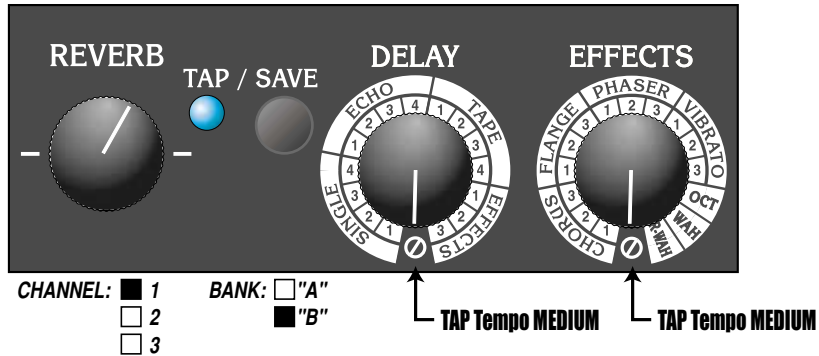

**Factory Preset 5: Rhythm w/Reverb**

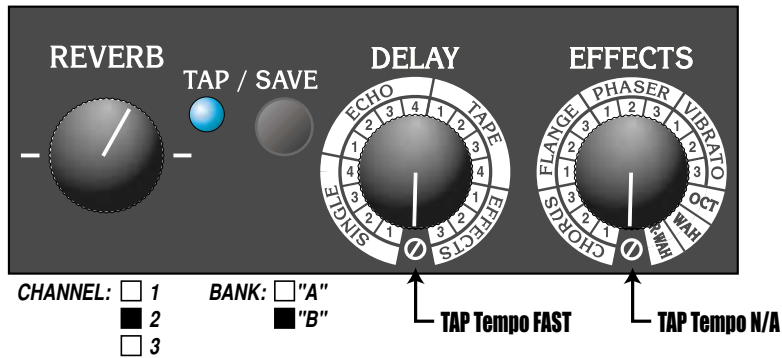

**Factory Preset 6: Solo w/Reverb**

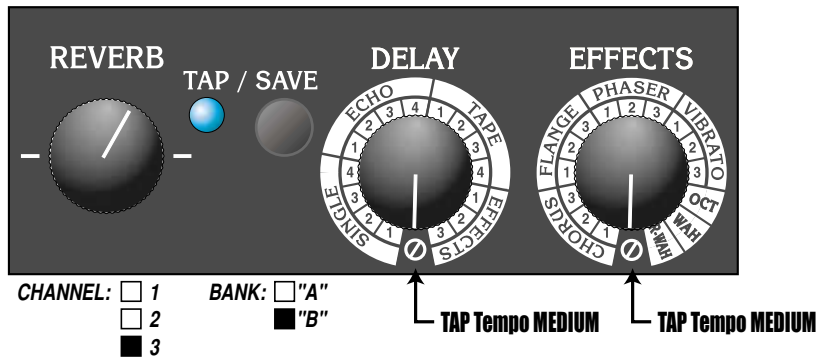

# CRATE VTX350H Three-Channel Guitar Amplifier with Advanced DSP

## Suggested Settings:

**"Oceanic"**  
Clean with Vibrato, Delay, & Reverb

TAP Tempo MEDIUM      TAP Tempo MEDIUM

**"Super Funk"**  
Clean with Wah, Delay, & Reverb

TAP Tempo FAST      TAP Tempo N/A

**"Arena"**  
Rhythm with Reverb & Delay

TAP Tempo MEDIUM      TAP Tempo N/A

**"Haze Faze"**  
Rhythm with Phase & Reverb

TAP Tempo N/A      TAP Tempo MEDIUM

**"Solo Wah"**  
Solo with Wah, Delay & Reverb

TAP Tempo N/A      TAP Tempo N/A

**"Octanator"**  
Solo with Octave & Reverb

TAP Tempo N/A      TAP Tempo N/A

# CRATE VTX350H Three-Channel Guitar Amplifier with Advanced DSP

## Suggested Settings:

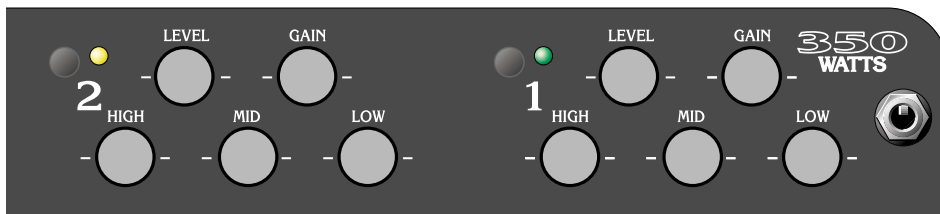
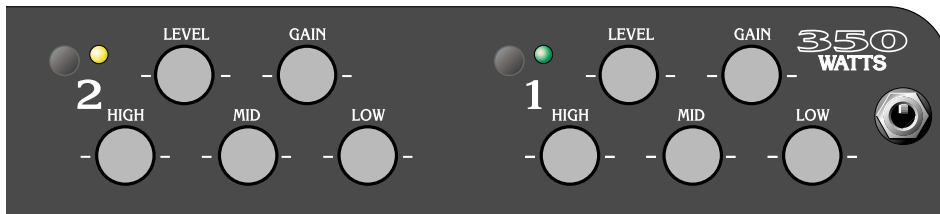
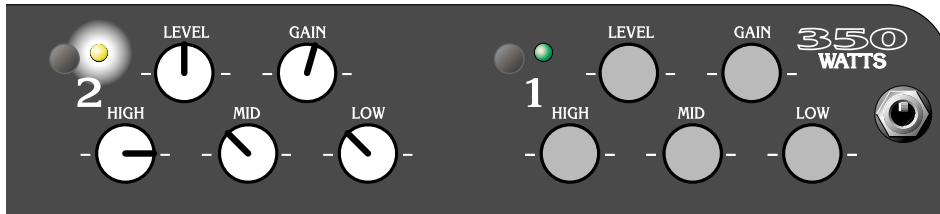
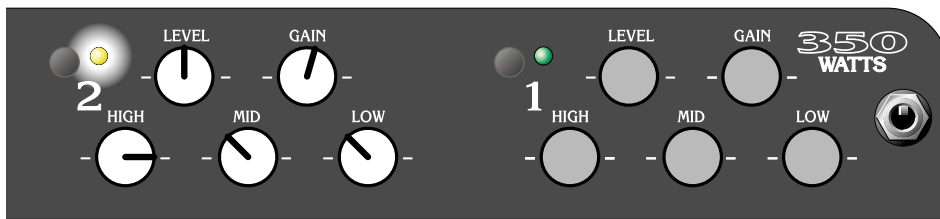
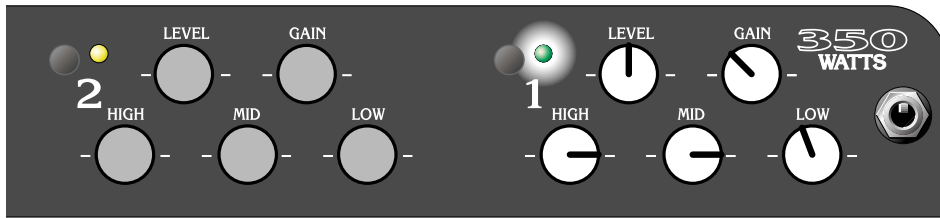
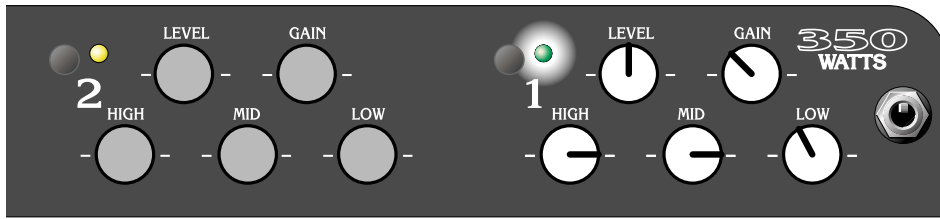



# CRATE VTX350H Three-Channel Guitar Amplifier with Advanced DSP

## System Block Diagram:

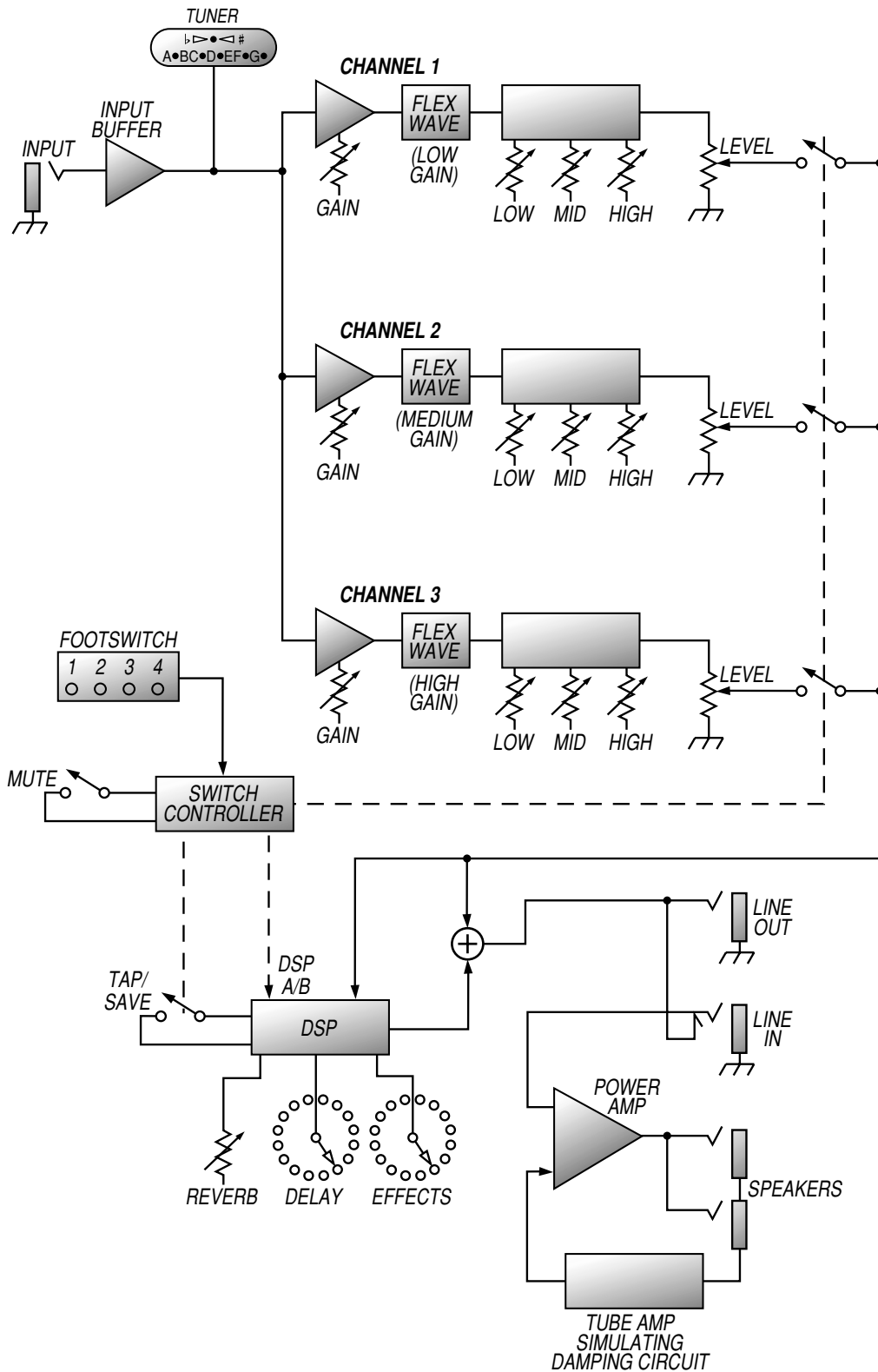

# **CRATE** VTX350H Three-Channel Guitar Amplifier with Advanced DSP

## **VTX350H TECHNICAL SPECIFICATIONS:**

Output Power Rating		350W RMS @5% THD, 2 $\Omega$ , 120 VAC
Input Impedance		470k $\Omega$
Total System Gain	Ch 1	74dB, all controls @10
	Ch 2	88dB, all controls @10
	Ch 3	103dB, all controls @10
Maximum Input Signal Accepted		5 volts peak-to-peak
Channel 1	Low Control	26dB range @ 70Hz
	Mid Control	10dB range @ 900Hz
	High Control	20dB range @ 10kHz
Channel 2	Low Control	26dB range @ 70Hz
	Mid Control	10dB range @ 900Hz
	High Control	20dB range @ 10kHz
Channel 3	Low Control	17dB range @ 100Hz
	Mid Control	16dB range @ 1kHz
	High Control	12dB range @ 7kHz
Power Requirements		120 VAC, 60Hz, 95VA 100/115VAC, 50/60Hz, 95VA; 230VAC, 50/60Hz, 95VA
Size and Weight		10" H x 30" W x 10.38" D, 41 lbs.

**The VTX350H is covered with a durable Tolex material: wipe it clean with a lint-free cloth. Never spray cleaning agents onto the cabinet. Avoid abrasive cleansers which would damage the finish.**

*Crate continually develops new products, as well as improves existing ones. For this reason, the specifications and information in this manual are subject to change without notice.*

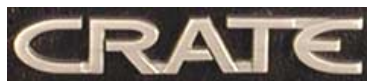

[www.crateamps.com](http://www.crateamps.com)

©2004 SLM Electronics, a division of St. Louis Music, Inc • 1400 Ferguson Avenue • St. Louis, MO 63133  
47-464-01 • 120104



## Free Manuals Download Website

<http://myh66.com>

<http://usermanuals.us>

<http://www.somanuals.com>

<http://www.4manuals.cc>

<http://www.manual-lib.com>

<http://www.404manual.com>

<http://www.luxmanual.com>

<http://aubethermostatmanual.com>

Golf course search by state

<http://golfingnear.com>

Email search by domain

<http://emailbydomain.com>

Auto manuals search

<http://auto.somanuals.com>

TV manuals search

<http://tv.somanuals.com>