

# CRATE

## BFX100 BASS AMPLIFIER

WITH  
DIGITAL SIGNAL  
PROCESSING

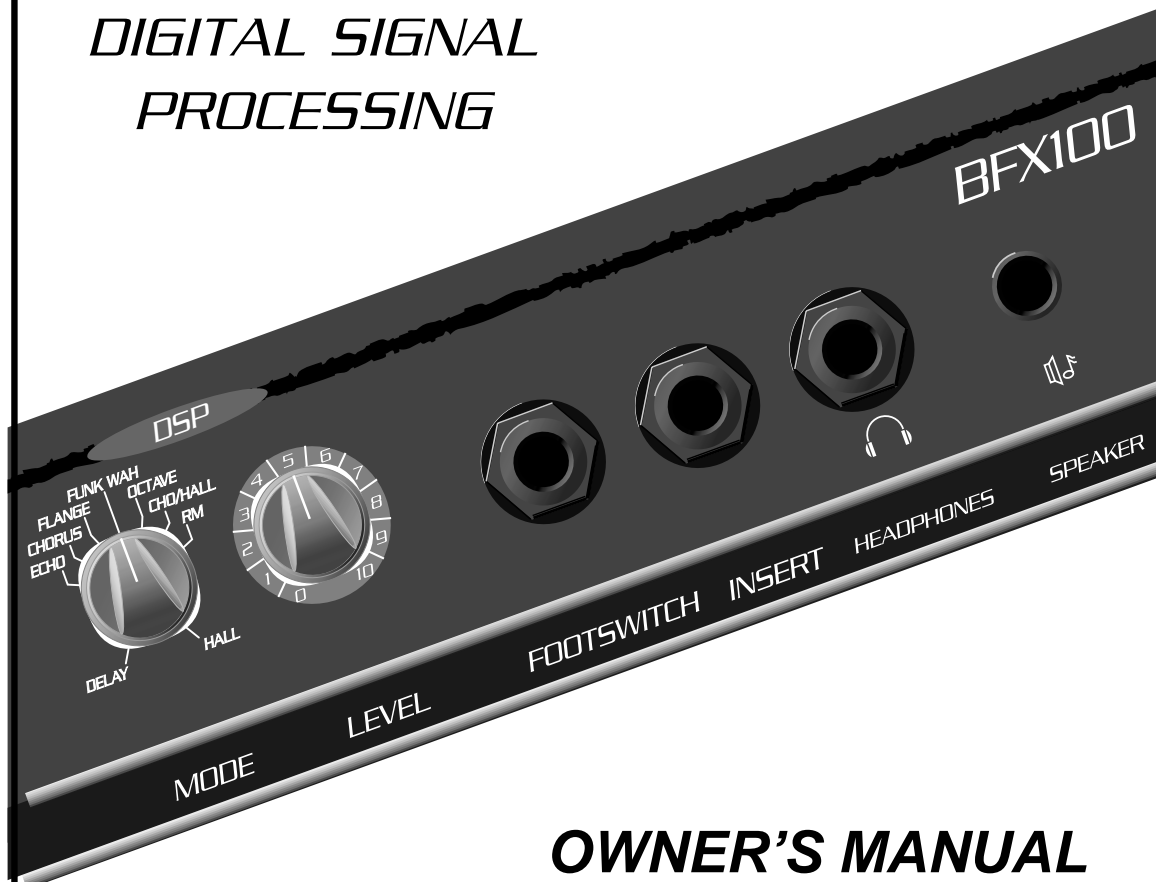

## OWNER'S MANUAL

### **Congratulations!**

You are now the proud owner of the portable and powerful Crate BFX100 Bass Amplifier with Digital Signal Processing. The BFX100 offers a wide selection of digital effects designed especially for the bass guitar, each of which are easily accessed with a simple turn of a control knob. (No programmer's degree required!) The BFX100 boasts an improved cabinet design with a front port, an extended range bass driver, an extremely clean power amp and very flexible tone circuitry. The balanced line out jack has a level control for the best signal match to a recording console or live PA system, and is selectable for either pre or post EQ. The built-in limiter ensures pure, clean power even at its full 100 watts output. An effects loop, a headphones jack, and an extension speaker jack add to the overall versatility of this incredible bass amp.

Your BFX100 is Musician Made in the U.S.A., using only the best components. Extensive testing at the hands (and ears) of skilled technicians and musicians ensures you that this amplifier is the absolute best it can be.

In order to get the most out of your new bass amp, we urge you to read this manual before you begin playing.

And ***thank you*** for choosing **CRATE**

### The Front Panel:

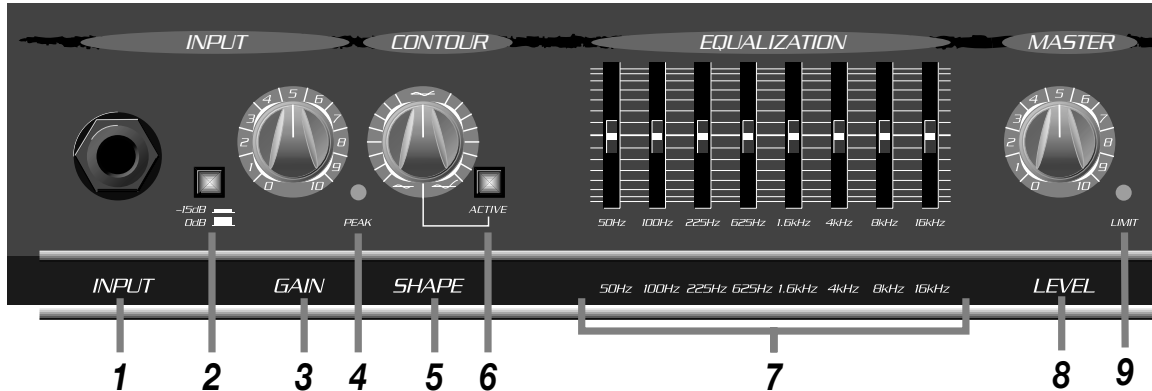

**1. INPUT:** The signal output from an instrument (active or passive) or a line level signal may be connected here by means of a shielded instrument cable.

**2. -15dB/0dB:** This switch, when depressed, attenuates the input signal by 15dB. Attenuation allows the Gain control (#3) to be functional over a larger portion of its range. If the Gain control is near minimum and the Peak LED (#4) is flashing (indicating clipping of the input signal), attenuation is needed.

**3. GAIN:** This serves as the input signal level control for the amplifier, allowing you to adjust the amplifier for the best signal to noise ratio.

**4. PEAK LED:** This LED flashes when the signal level into the preamp approaches clipping. Adjust the Gain control (#3) until a strong signal from your instrument causes this LED to flicker.

**NOTE:** If the LED flashes frequently with the gain control at a low setting, use the -15dB pad (#2) to attenuate the input signal, then readjust the gain.

**5. CONTOUR SHAPE:** This control is only active when the Contour Active switch (#6) is

depressed. The setting of this control shifts the frequency where the contour effect is centered, giving you a wide variety of tonal variations, from a studio “V”-shaped tone to a sound that’s more “live” and up-front.

**6. CONTOUR ACTIVE:** This switch, when depressed, activates the Contour Shape control (#5).

**7. GRAPHIC EQ:** Use these sliders to adjust the output signal to best suit your playing style, to match room acoustics, and to get the best overall sound. The sliders control the output of the frequencies indicated below each control. The center position of each control is flat (no boost or cut).

**8. MASTER LEVEL:** This is the overall output level control for the amplifier.

**9. LIMIT:** The BFX100 uses an internal limiting circuit to assist in keeping the power amplifier’s output “clean” at extreme volume levels. (All amplifiers begin to clip their output signals as they approach maximum output levels, resulting in distortion which may damage the speaker.) Whenever the amplifier is at full power, this LED will flash. This is an indication that the limiter is keeping peak signals from clipping the output.

# CRATE BFX100 Bass Amplifier

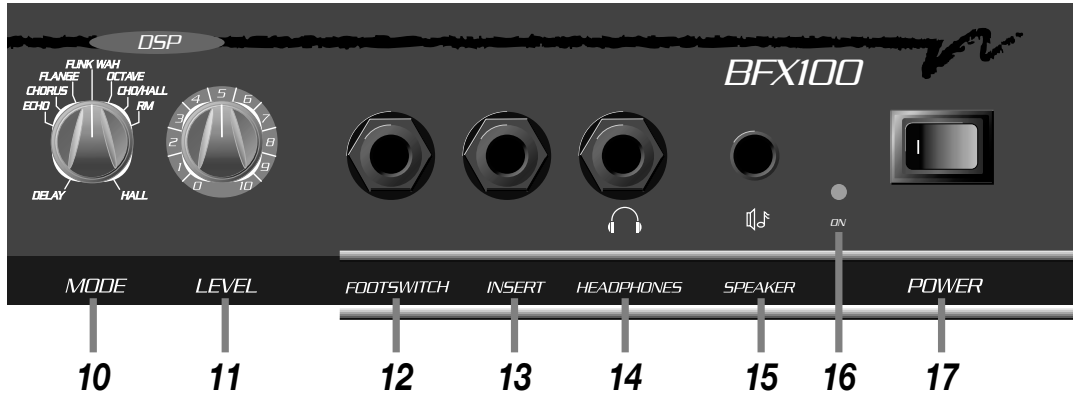

**10. DSP MODE:** Select the type of digital effect(s) applied to the signal with this control. The effects are described as follows:

**DELAY:** Slapback delay effect

**ECHO:** Long delay effect with regeneration

**CHORUS:** Chorus effect

**FLANGE:** Light flange effect

**FUNK-WAH:** Touch-sensitive wah-wah ("T-Wah") effect

**OCTAVE:** Adds secondary note one octave lower than original note

**CHO/HALL:** Chorus effect with large hall reverb effect

**RM:** Small room reverb effect

**HALL:** Large hall reverb effect

**11. DSP LEVEL:** This is the output level control for the selected DSP effect(s). For a dry signal (no effect), rotate the control full counter-clockwise. Rotating the control clockwise increases the magnitude of the DSP effect(s) applied to the signal.

**12. DSP FOOTSWITCH:** Connect a one button footswitch (such as the Crate CFP-1) here for remote on/off control for the internal DSP effects.

**13. INSERT:** Connect an external effects device using this jack. Use a stereo 1/4" male Y-cord: ring = send, tip = return, sleeve = ground. See the illustration to the right for more information.

**14. HEADPHONES:** For private listening, connect a pair of stereo headphones into this jack. The internal speaker is disconnected when headphones are plugged in.

**15. SPEAKER:** Use this jack to connect the amplifier to an external speaker with a minimum impedance rating of 4 ohms. The internal speaker is disconnected when this jack is used.

**WARNING: TO AVOID POSSIBLE HEARING DAMAGE, DO NOT USE HEADPHONES IN THE SPEAKER JACK!**

**16. ON LED:** This LED will illuminate when the amplifier is turned on.

**17. POWER:** This switch applies AC power to the amplifier. The amplifier is ON when the side of the switch with the indicator (I) is depressed.

## The Rear Panel:

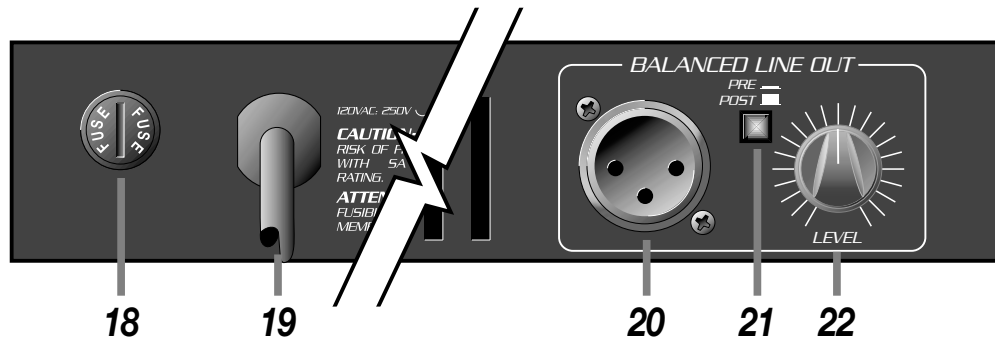

**18. FUSE:** This protects the unit from damage due to overload conditions or power line surges. If the fuse blows, replace it only with the same size and type.

**19. AC LINE CORD:** Plug this cord into a properly wired, grounded, 120 volt, 60 cycle outlet. **DO NOT attempt to defeat the ground connection of this power cord!** If your amplifier was purchased outside of the United States, see the unit's rear panel labeling for its power rating, and follow the above guidelines.

**20. BALANCED LINE OUT:** This XLR-type connector supplies a balanced preamp output signal for connecting to a house mixing board, recording console or external amplifier with balanced inputs. The signal can be set to Pre or Post EQ by the Pre/Post switch (#21). The line out signal level can be controlled by the Balanced Line Out Level control (#22).

**21. PRE/POST SWITCH:** You can select either Pre or Post EQ for the signal at the Balanced Line Out jack (#20) with this switch. When the switch is depressed, the signal at the jack is pre-EQ—a direct output, not affected by the gain, contour, or graphic EQ. When the switch is in the out position, the signal is

post-EQ—the output signal is affected by the gain, contour and graphic EQ controls.

**22. BALANCED LINE OUT LEVEL:** Use this control to adjust the output signal at the Balanced Line Out jack (#20). This control works independently from the the front panel Master Level control.

### Connecting to the Insert jack:

The Insert jack (#13) lets you patch external effects into the amplifier just prior to its power amp stage. Use Crate's STP201, STP202 or STP203 stereo-to-mono Y-cord or an adapter such as Crate's YPP117 and 2 1/4" mono signal cables to connect to the effect as shown below.

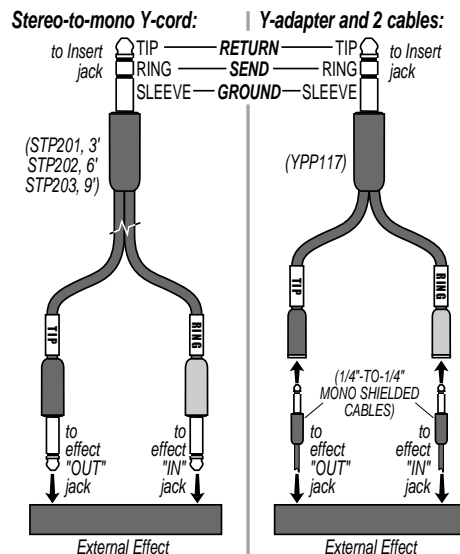

# CRATE BFX100 Bass Amplifier

## Suggested Starting Tone Settings:

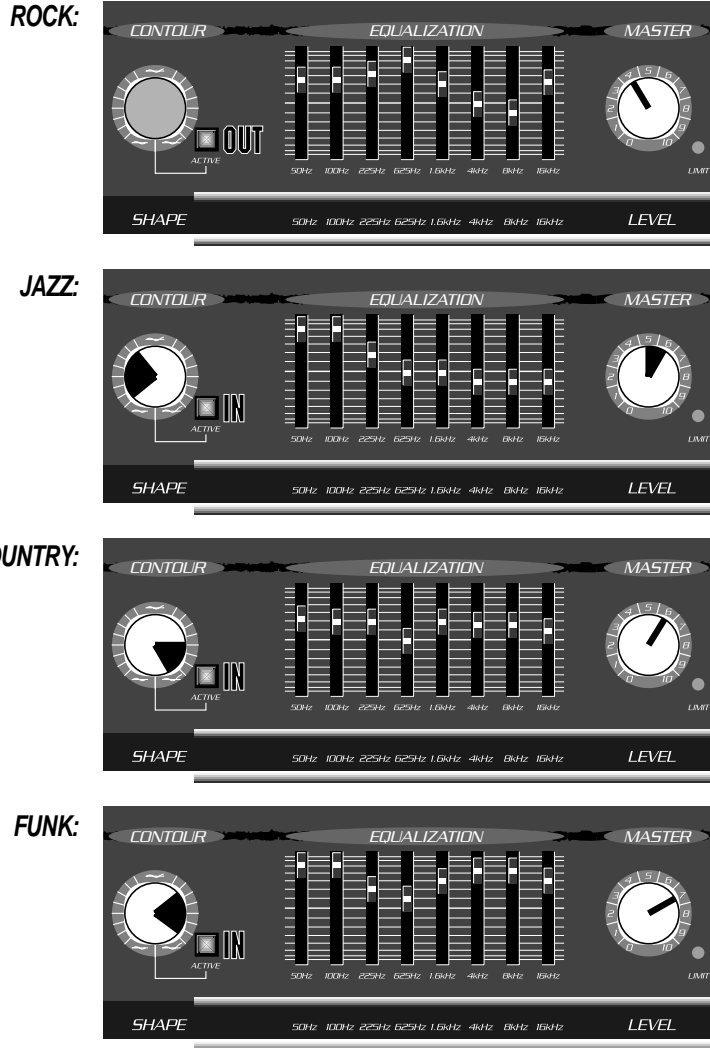

## System Block Diagram:

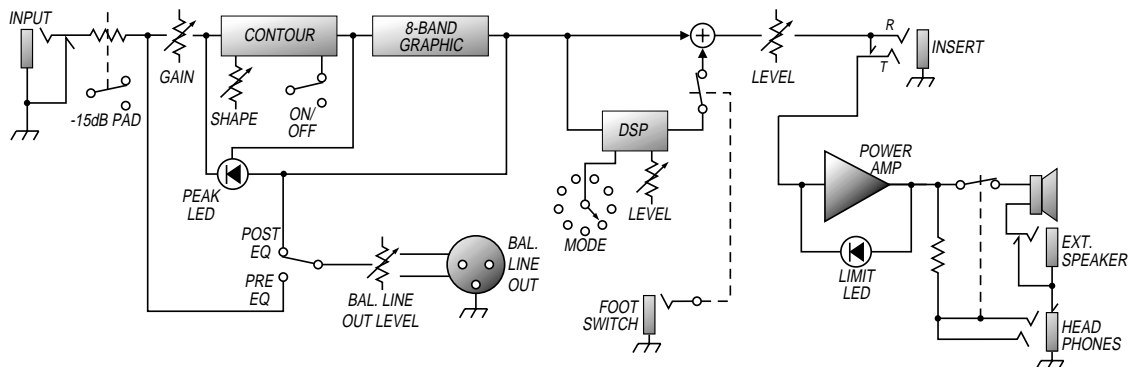







# CRATE BFX100 Bass Amplifier

## BFX100 Technical Specifications:

Output Power Rating	100 watts RMS @ 1% THD 4 ohms, 120 VAC
Speaker Size and Rating	Custom Design 15" with 2" voice coil Power Handling: 150 watts RMS
Graphic Equalizer	24dB range @ 50Hz, 100Hz, 225Hz, 625Hz, 1.6kHz 4kHz, 8kHz and 16kHz
Input Impedance	200k ohms
Maximum Input Signal Level Accepted	15 volts, peak-to-peak
Gain @ 1kHz	65dB w/EQ flat, contour off
Line Output Jack	2 volts peak-to-peak @ full rated power
Balanced Line Out Jack	2 volts peak-to-peak @ full rated power w/600Ω load
Signal to Noise Ratio	65dB below full power, tones flat, contour off, gain and level @ "10"
Input Power Requirements	120 VAC, 60Hz, 115VA 100/110VAC, 50/60Hz, 115VA 230VAC, 50/60Hz, 115VA
Size and Weight	25" H x 20.75" W x 15.75" D, 67 lbs.

*Specifications subject to change without notice.*

 <b>CAUTION</b> RISK OF ELECTRIC SHOCK DO NOT OPEN	<p>THIS EQUIPMENT HAS BEEN DESIGNED AND ENGINEERED TO PROVIDE SAFE AND RELIABLE OPERATION. IN ORDER TO PROLONG THE LIFE OF THE UNIT AND PREVENT ACCIDENTAL DAMAGES OR INJURY, PLEASE FOLLOW THESE PRECAUTIONARY GUIDELINES:</p> <p><b>CAUTION:</b> TO REDUCE THE RISK OF ELECTRIC SHOCK, DO NOT OPEN CHASSIS; DO NOT DEFEAT OR REMOVE THE GROUND PIN OF THE POWER CORD; CONNECT ONLY TO A PROPERLY GROUNDED AC POWER OUTLET.</p> <p><b>WARNING:</b> TO REDUCE THE RISK OF FIRE OR ELECTRIC SHOCK, DO NOT EXPOSE THIS EQUIPMENT TO RAIN OR MOISTURE.</p> <p><b>CAUTION:</b> NO USER-SERVICEABLE PARTS INSIDE. REFER SERVICING TO QUALIFIED SERVICE PERSONNEL.</p> <p><b>CAUTION:</b> OUR AMPLIFIERS ARE CAPABLE OF PRODUCING HIGH SOUND PRESSURE LEVELS. CONTINUED EXPOSURE TO HIGH SOUND PRESSURE LEVELS CAN CAUSE PERMANENT HEARING IMPAIRMENT OR LOSS. USER CAUTION IS ADVISED AND EAR PROTECTION IS RECOMMENDED IF UNIT IS OPERATED AT HIGH VOLUME.</p>	<p>ESTE APARATO HA SIDO DISEÑADO Y CONSTRUIDO PARA PROVEER AÑOS DE OPERACION SEGURA Y CONFIABLE. PARA PROLONGAR LA VIDA DE ESTA UNIDAD E IMPEDIR DANOS ACCIDENTALES POR FAVOR SIGA ESTAS INSTRUCCIONES PREVENTIVAS:</p> <p><b>PRECAUCION:</b> PARA DISMINUIR EL RIESGO DE DESCARGAS ELECTRICAS: (1) NO ABRA LA CUBIERTA. (2) NO ES RECOMENDABLE REMOVER O DESACTIVAR LA PATA DEL POLO A TIERRA DEL CABLE DE CORRIENTE, CONECTE CORRECTAMENTE A UNA TOMA DE CORRIENTE A TIERRA.</p> <p><b>ADVERTENCIA:</b> PARA EVITAR DESCARGAS EL ECTRICAS O PELIGRO DE INCENDIO, NO DEJE ESTE APARATO EXPUESTO A LA LLUVIA O HUMEDAD.</p> <p><b>PRECAUCION:</b> NO HAY PIEZAS ADENTRO QUE EL USUARIO PUEDE REPARAR. DEJE TODO MANTENIMIENTO A LOS TECNICOS CALIFICADOS.</p> <p><b>PRECAUCION:</b> NUESTROS AMPLIFICADORES PUEDEN PRODUCIR NIVELES DE PRESION DE SONIDO ALTO. EXPOSICION CONTINUADA A LOS NIVELES DE PRESION DE SONIDO ALTO PUEDE CAUSA DANO PERMANENTE A SU OIDO. ES ACONSEJADO QUE USE PRECAUCION AL USUARIO Y ES RECOMENDADO PROTECCION PARA LOS OIDOS SI LA UNIDAD ES OPERADA A VOLUMEN ALTO.</p>	<p>CET ÉQUIPEMENT AVAIT ÉTÉ INVENTÉ ET ARRANGÉ POUR POURVOIR DES ANNÉES D'USAGE SAUF ET SÛR. POUR PROLONGER LA VIE DE CET APPAREIL ET POUR EMPÊCHER LES DOMMAGES ET LES TORTS ACCIDENTELS, SUIVEZ LES INSTRUCTIONS DE PRECAUTION.</p> <p><b>AVERTISSEMENT:</b> POUR RÉDUIRE LES RISQUES D'ÉLECTROCUTION: (1) N'OUVREZ PAS LE CHÂSSIS. (2) NE PAS ESSAYER DE SUPPRIMER LA BROCHE CORRESPONDANT À LA TERRE.</p> <p><b>ATTENTION:</b> POUR RÉDUIRE LES RISQUES D'UN FEU OU D'ÉLECTROCUTION, N'EXPOSEZ PAS L'APPAREIL À LA PLUIE OU À LA MOI-TEUR.</p> <p><b>ATTENTION:</b> IL N'Y A PAS D'ÉLÉMENTS RÉPARABLES DANS L'APPAREIL. CONSULTEZ UN TECHNICIEN QUALIFIÉ POUR LES RÉPARATIONS.</p> <p><b>ATTENTION:</b> NOS AMPLIFICATEURS SONT CAPABLES DE LA PRODUCTION DES NIVEAUX DE SON D'UNE HAUTE PRESION. L'EXPOSITION CONTINUE AUX CES NIVEAUX PEUT CAUSER LA SURDITÉ PERMANENTE. LA PRUDENCE EST ADVISÉ À UTILISATEUR ET LA PROTECTION DES OREILLES EST RECOMMANDÉ SI L'APPAREIL EST UTILISÉ À UN HAUT NIVEAU DE VOLUME.</p>
 <b>PRECAUCION</b> RIESGO DE CORRIENTAZO NO ABRA	<p><b>PRECAUCION:</b> PARA DISMINUIR EL RIESGO DE CORRIENTAZO NO ABRA LA CUBIERTA NO HAY PIEZAS ADENTRO QUE EL USUARIO PUEDO REPARAR DEJE TODO MANTENIMIENTO A LOS TECNICOS CALIFICADOS</p>		
 <b>ATTENTION</b> RISQUE D'ELECTROCUTION NE PAS OUVRI	<p><b>ATTENTION:</b> POUR REDUIRE D'ELECTROCUTION NE PAS ENLEVER LE COUVERCLE. AUCUNE PIECE INTERNE N'EST REPRABLE PAR L'UTILISATEUR. POUR TOUTE REPARATION, S'ADRESSER A UN TECHNICIEN QUALIFIE.</p>		
 <b>VORSICHT</b> ELEKTRISCHE SCHLAGEFAHR NICHT OFFENEN	<p><b>VORSICHT:</b> ZUR MINIMIERUNG ELEKTRISCHER SCHLAGEFAHR NICHT DEN DECKEL ABENHMEN. INTERNE TEILE KONNEN NICHT VOM BENUTZER GEWARTET WERDEN. DIE WARTUNG IS QUALIFIZIERTEM WARTUNGSPERSONAL ZU UBERLASSEN.</p>		
<p>EXPLANATION OF GRAPHICAL SYMBOLS:          EXPLICACION DE SIMBOLOS GRAFICOS:          EXPLICATION DES SYMBOLES GRAPHIQUES:</p>	 = "DANGEROUS VOLTAGE" "VOLTAJE PELIGROSO" "DANGER HAUTE TENSION" "GEFAHLICHE SPANNUNG"	 = "IT IS NECESSARY FOR THE USER TO REFER TO THE INSTRUCTION MANUAL" "ES NECESARIO QUE EL USUARIO SE REFIERA AL MANUAL DE INSTRUCCIONES." "REFERREZ-VOUS AU MANUAL D'UTILISATION" "UNBEDINGT IN DER BEDIENUNGSANLEITUNG NACHSCHLAGEN"	

The BFX100 is covered with a durable black Tolex material: wipe it clean with a lint-free cloth. Never spray cleaning agents onto the cabinet. Avoid abrasive cleansers which would damage the finish.

**CRATE**  
www.crateamps.com



©2001 SLM ELECTRONICS, A DIVISION OF ST. LOUIS MUSIC, 1400 FERGUSON, ST. LOUIS, MO. 63133  
P/N 47-354-02 • 05/01

## Free Manuals Download Website

<http://myh66.com>

<http://usermanuals.us>

<http://www.somanuals.com>

<http://www.4manuals.cc>

<http://www.manual-lib.com>

<http://www.404manual.com>

<http://www.luxmanual.com>

<http://aubethermostatmanual.com>

Golf course search by state

<http://golfingnear.com>

Email search by domain

<http://emailbydomain.com>

Auto manuals search

<http://auto.somanuals.com>

TV manuals search

<http://tv.somanuals.com>