

CRATE

BV120H



All Tube Guitar Amplifier



User's Guide

Congratulations!

Your love of performing and driving ambition to be the best have brought you to a turning point in your musical career: the incredible BV120H All Tube guitar amplifier. A powerhouse of an amplifier designed to take you to the top and keep you there.

We know something about you: we know you were never impressed with those "toys" that some of your friends called amplifiers. We know you were holding out until **someone** offered you an American-made, affordable piece of professional equipment you could really sink your teeth into. A serious amplifier, designed for a serious musician: an amp with the sounds you've always looked for, the power you've always dreamed about, and the reliability you know you'll need. And all with a name you **know** you can trust: CRATE.

Your BV120H was designed by musicians, and built using only the best components. Extensive testing at the hands and ears of skilled technicians and musicians insures you that this amplifier is the absolute best it can be.

In order to get the most out of your new amplifier, we strongly urge you to read this user's guide before you begin playing.

And **thank you** for choosing CRATE.

Table Of Contents:

Introduction	3
Features	3
The Front Panel	4
The Rear Panel	5
Important Information About Tubes and Tube Products	
A Brief History Of The Tube	6
Tube Types And Usage	6
The Nature Of Tubes: Why (And When) To Replace Them	7
The Importance Of Proper Biasing	7
Survival Tips For Tube Amplifiers	8
Some Suggested Settings	9
System Block Diagram	10
Technical Specifications	back cover

	CAUTION RISK OF ELECTRIC SHOCK DO NOT OPEN	
<small>WARNING: TO REDUCE THE RISK OF FIRE OR ELECTRIC SHOCK, DO NOT EXPOSE THIS APPARATUS TO RAIN OR MOISTURE. TO REDUCE THE RISK OF ELECTRIC SHOCK, DO NOT REMOVE COVER. NO USER-SERVICEABLE PARTS INSIDE. REFER SERVICING TO QUALIFIED SERVICE PERSONNEL.</small>		

	PRECAUCION RIESGO DE CORRIENTAZO NO ABRA	
<small>PRECAUCION: PARA REDUCIR EL RIESGO DE INCENDIOS O DESCARGAS ELECTRICAS, NO PERMITA QUE ESTE APARATO QUEDA EXPUESTO A LA LLUVIA O LA HUMEDAD. PARA DISMINUIR EL RIESGO DE CORRIENTAZO, NO ABRA LA CUBIERTA. NO HAY PIEZAS ADENTRO QUE EL USUARIO PUEDA REPARAR. DEJE TODO MANTENIMIENTO A LOS TECNICOS CALIFICADOS.</small>		

	ATTENTION RISQUE D'ELECTROCUTION NE PAS OUVRIR	
<small>ATTENTION: PROTEGEZ CET APPAREL DE LA PLUIE ET DE L'HUMIDITE AFIN D'EVITER TOUT RISQUE D'INCENDIE OU D'ELECTROCUTION. POUR REDUIRE D'ELECTROCUTION NE PAS ENLEVER LE COUVERCLE. AUCUNE PIECE INTERNE N'EST REPARABLE PAR L'UTILISATEUR. POUR TOUTE REPARATION, S'ADRESSEZ A UN TECHNICIEN QUALIFIE.</small>		

IMPORTANT SAFETY INSTRUCTIONS

- READ, FOLLOW, HEED, AND KEEP ALL INSTRUCTIONS AND WARNINGS.
- DO NOT OPERATE NEAR ANY HEAT SOURCE AND DO NOT BLOCK ANY VENTILATION OPENINGS ON THIS APPARATUS. FOR PROPER OPERATION, THIS UNIT REQUIRES 3" (75CM) OF WELL VENTILATED SPACE AROUND HEATSINKS AND OTHER AIR FLOW PROVISIONS IN THE CABINET.
- DO NOT USE THIS APPARATUS NEAR SPLASHING, FALLING, SPRAYING, OR STANDING LIQUIDS.
- CLEAN ONLY WITH LINT-FREE DAMP CLOTH AND DO NOT USE CLEANING AGENTS.
- ONLY CONNECT POWER CORD TO A POLARIZED, SAFETY GROUNDING OUTLET WIRED TO CURRENT ELECTRICAL CODES AND COMPATIBLE WITH VOLTAGE, POWER, AND FREQUENCY REQUIREMENTS STATED ON THE REAR PANEL OF THE APPARATUS.
- PROTECT THE POWER CORD FROM DAMAGE DUE TO BEING WALKED ON, PINCHED, OR STRAINED.
- UNPLUG THE APPARATUS DURING LIGHTNING STORMS OR WHEN UNUSED FOR LONG PERIODS OF TIME.
- ONLY USE ATTACHMENTS, ACCESSORIES, STANDS, OR BRACKETS SPECIFIED BY THE MANUFACTURER FOR SAFE OPERATION AND TO AVOID INJURY.
- WARNING: TO REDUCE THE RISK OF ELECTRIC SHOCK OR FIRE, DO NOT EXPOSE THIS UNIT TO RAIN OR MOISTURE.
- SERVICE MUST BE PERFORMED BY QUALIFIED PERSONNEL.
- OUR AMPLIFIERS ARE CAPABLE OF PRODUCING HIGH SOUND PRESSURE LEVELS. CONTINUED EXPOSURE TO HIGH SOUND PRESSURE LEVELS CAN CAUSE PERMANENT HEARING IMPAIRMENT OR LOSS. USER CAUTION IS ADVISED AND EAR PROTECTION IS RECOMMENDED IF UNIT IS OPERATED AT HIGH VOLUME.



EXPLANATION OF GRAPHICAL SYMBOLS:
EXPLICACION DE SIMBOLOS GRAFICOS:
EXPLICATION DES SYMBOLES GRAPHIQUES:

 = "DANGEROUS VOLTAGE"
"VOLTAJE PELIGROSO"
"DANGER HAUTE TENSION"

 = "IT IS NECESSARY FOR THE USER TO REFER TO THE INSTRUCTION MANUAL"
"ES NECESARIO QUE EL USUARIO SE REFIERA AL MANUAL DE INSTRUCCIONES."
"REFERREZ-VOUS AU MANUAL D'UTILISATION"

Introduction:

The BV120H is an all-tube, feature-packed professional stage performers' amplifier. Rugged construction, reliable American craftsmanship and two powerful channels of pure tube power are some of the trademarks of this new and impressive piece of musician's equipment. This amplifier features two distinctly different 12AX7 tube-driven channels: one with classic tube rhythm sounds and one offering you some of the finest lead and overdrive sounds of any stock amplifier.

Each channel features an all-tube preamp section with separate reverb level controls and three bands of equalization for total tone control. The master Presence control lets you custom tailor the sound of your guitar to suit your particular needs. The effects loop can be quickly bypassed via the front panel switch or an optional footswitch and features a switchable "pad" for use with either floor pedals or rack-mounted effects.

The Line Out signal is tapped directly from the speaker outputs, then attenuated and frequency-compensated to replicate the sound of a miked speaker cabinet. Dual speaker jacks and an impedance selector switch allow the use of multiple cabinets totalling 8 or 16 ohms. The BV120H packs a solid 100 watts of output power.

Features:

Here's a quick overview of the BV120H's features and controls. Additional information can be found on the pages indicated.

- **All-Tube Preamp and Power Amp:** Classic tube sounds with Crate's legendary performance and reliability.
- **Two Completely Separate Channels:** Independent level, tone and reverb controls (*page 4*).
- **Presence Control:** Provides even greater tone control and flexibility by allowing you to vary the upper harmonics of your guitar (*page 4*).
- **Footswitch Control:** Remote channel selection and Effects Loop On/Off is available through the use of an optional two-button footswitch (such as Crate's CFP-2) (*page 5*).
- **Switchable Effects Loop with Pad:** Footswitch or front panel button controlled, the external effects loop can be switched in or out with ease. A switchable pad provides optimum performance from line-level rack mounted effects as well as floor-dwelling foot pedals (*pages 4,5*).
- **Impedance Selector Switch:** Proper impedance matching is essential for optimum performance and life expectancy of a tube amplifier. These amps allow the use of 8 or 16 ohm speaker configurations (*page 5*).
- **Line Out Jack:** Taken directly from the speaker output jacks, the Line Out signal is frequency compensated to sound like a "miked" speaker cabinet. Use this jack to connect to the house mixing board, a recording console or another performer's powered monitor (*page 5*).
- **DC Filament Supply:** The first preamp tube has a DC filament supply for reduced hum.
- **High Cosmetic Appeal and Stage Presence:** The unique cosmetics of the BV120H serve as a tribute to your good taste in musical equipment.
- **Musician Made in the U.S.A.**

The Front Panel:

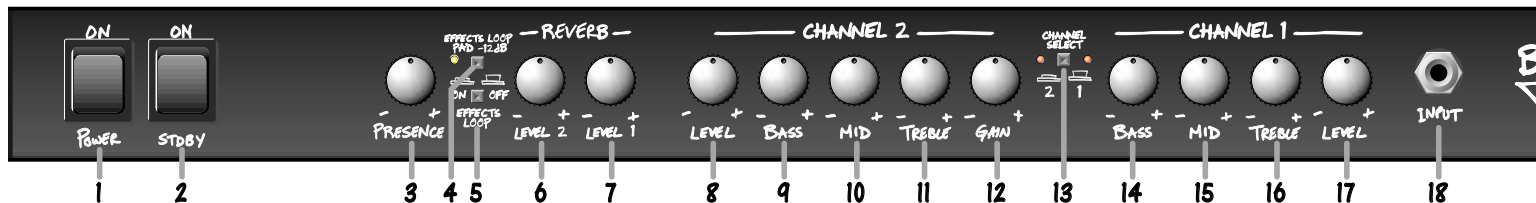

1. POWER: This switch applies AC voltage to the amplifier, and should always be turned **on first**. The switch illuminates when the AC power is on.

2. STANDBY: This switch activates the amplifier, and should always be turned **on last**. The switch illuminates when the high voltage power is passing through to the tubes.

NOTE: When you first power up this amplifier, leave the Standby switch **OFF** for at least 20 seconds. This gives the power tubes a chance to prepare themselves for action.

3. PRESENCE: Increase the level of upper harmonics with this control. The presence control allows a boost of up to 5dB at 10kHz.

4. EFFECTS LOOP PAD: This switch activates a 12dB pad on the effects send signal and corresponding gain recovery on the return. In the out position the signal is full strength which is best suited for line level rack mountable effects. With the switch depressed the signal is lower which is best suited for foot pedal type effects.

5. EFFECTS LOOP SWITCH: This switch controls the effects return signal of the effects loop. The loop is only active when the switch is pressed in. When a footswitch is used, this switch is disabled. The adjacent yellow LED illuminates when the loop is in use.

6,7. REVERB 2, REVERB 1: Adjust the amount of reverberation on each channel with these controls: at the "0" position the signal is "dry" (no reverb). As you rotate the control clockwise, the amount of reverb increases.

Channel 2:

8. LEVEL: Set the output signal level of channel 2 with this control. At the "0" position (full left) very little or no signal will be heard; as you rotate the control clockwise (towards center) the output level of channel 2 increases. Use this control along with your guitar's volume and the channel 2 gain control (#12) to produce a wide variety of sounds.

9. BASS: Adjust the bottom end response with this control. The low control covers a range of 15dB at 100Hz. This sets the amount of bass heard (and felt) from the amp.

10. MID: Adjust the midrange response with this control. The mid control covers a range of 13dB at 500Hz. This controls the "voice" of your guitar.

11. TREBLE: Adjust the high end response with this control. The high control covers a range of 10dB at 10kHz. This controls the "bite" of your guitar.

12. GAIN: Adjust the overdrive (distortion) level with this control. With the control towards "0" (to the left) the signal is relatively clean. As you rotate the control clockwise the distortion increases, along with the overall output level. Rotate the control towards "10" and you'll increase the distortion even more.

13. CHANNEL SELECT: Switch between channels with this push-button switch. The adjacent amber LED illuminates when channel 1 is selected (switch in the out position), the red LED illuminates when channel 2 is selected (switch depressed). When a footswitch is used for channel switching, this switch is disabled.

Channel 1:

14. BASS: Adjust the bottom end response with this control. The low control covers a range of 16dB at 100Hz. This sets the amount of bass heard (and felt) from the amp.

15. MID: Adjust the midrange response with this control. The mid control covers a range of 20dB at 300Hz. This controls the "voice" of your guitar.

16. TREBLE: Adjust the high end response with this control. The high control covers a range of 10dB at 10kHz. This controls the "bite" of your guitar.

17. LEVEL: Set the output volume level of channel 1 with this control.

18. INPUT: Connect your guitar or wireless receiver into this standard 1/4" jack by means of a shielded instrument cable.

The Rear Panel:

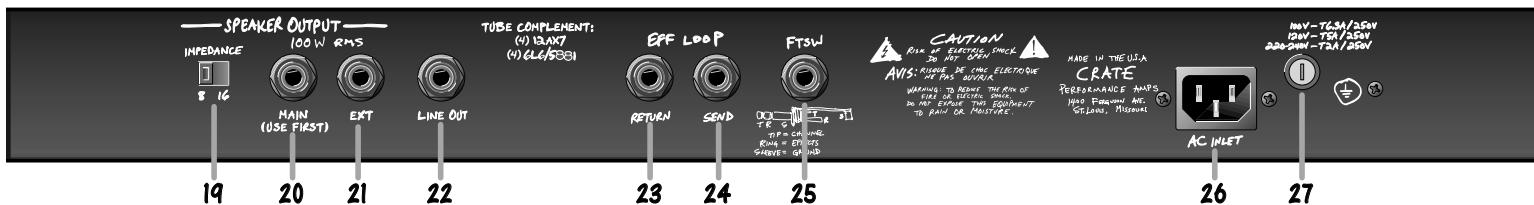

19. IMPEDANCE SELECTOR: For the best performance and least strain on your amplifier, you **MUST** properly match the impedance of your amplifier to that of your speaker cabinet(s). Set the selector switch to the 8 or 16 ohm position, depending on the **total** impedance of your speaker cabinet(s). The chart below can help you determine that impedance based on the following combinations of speakers connected in parallel.

CAB. IMP.	# OF CABS.	TOTAL IMP.
8 OHMS	1	8 OHMS
16 OHMS	1	16 OHMS
16 OHMS	2	8 OHMS
32 OHMS	2	16 OHMS
32 OHMS	4	8 OHMS

20. MAIN SPEAKER JACK: Use this jack to connect the amplifier to your primary speaker cabinet by means of a heavy gauge speaker cable. **Always keep the impedance at 8 or 16 ohms**, with the impedance selector switch (#19) at the proper setting.

NOTE: Use the **MAIN SPEAKER** jack **first**. Then, if an extension speaker is desired, connect it to the **EXT. SPEAKER** jack.

21. EXT. SPEAKER JACK: Use this jack to connect the amplifier to a secondary speaker cabinet by means of a heavy gauge speaker cable, **after** a speaker has been connected to the main speaker jack (#20).

22. LINE OUT JACK: This 1/4" jack supplies a line-level output signal from the power amp for patching into a mixing board, recording console or external amplifier. The signal is tapped directly from the speaker outputs, then attenuated and electronically compensated to simulate the sound of a "miked" cabinet.

23. EFFECTS LOOP RETURN: Connection from an external effects device is made via this jack. Connect a shielded instrument patch cord from the output jack of the effect to the return jack. This jack is active only when the effects loop is switched in. The return jack also doubles as a "power amp in" jack, to feed a line-level signal directly into the BV120H's internal power amp. This is useful when "slaving" two amplifiers together.

24. EFFECTS LOOP SEND: Connection to an external effects device is made via this jack. Connect a shielded instrument patch cord from the send jack to the input jack of the effect. This jack is always active. The send jack also doubles as a "preamp out" jack, to feed a post-eq, pre-amplified signal to a mixing board, recording console or external amplifier.

25. FOOTSWITCH JACK: Connect a stereo 1/4" (tip/ring/sleeve) here from a two-button footswitch (such as the Crate CFP-2) for remote control of channel switching and the effects loop. The tip of the jack is for the channel switching; the ring is for the effects loop. When a footswitch is connected here, the front panel channel select and effects loop switches are disabled.

26. AC LINE IN: This grounded power cord is to be plugged into a grounded power outlet, wired to current electric codes and compatible with voltage, power, and frequency requirements stated on the rear panel. **Do not attempt to defeat the safety ground connection.**

27. FUSE: This fuse protects the amplifier against damages caused by overload conditions in the unit. If the fuse fails, replace it only with the same size and type as indicated on the rear panel. If the fuse fails continually, the line voltage may be incorrect, or the amp may need servicing.

Important Information About Tubes And Tube Products:

A Brief History Of The Tube:

In 1883, Edison discovered that electrons would flow from a suspended filament when enclosed in an evacuated lamp. Years later, in 1905, Fleming expanded on Edison's discovery and created the "Fleming Valve". Then, in 1907, Dr. Lee de Forest added a third component – the grid – to the "Fleming's Valve" and the vacuum tube was a fact of life. The door to electronic amplification was now open.

During World War II, data gleaned from their intensive research on the detectors used in radar systems led Bell Telephone Laboratories to the invention of the transistor. This reliable little device gained quick support as the new component for amplification. The death of the vacuum tube seemed imminent as designers, scientists, and engineers reveled in the idea of replacing large, fragile glass tubes with these small, solid-state devices.

However, there were (and still are) many serious listeners who realized that the sound produced by a "transistor" amplifier is significantly different from that produced by a tube amplifier with identical design specifications. They considered the sound produced by these new solid-state devices to be hard, brittle, and lifeless. It was determined that solid-state devices produced a less musical set of harmonics than tubes. When pushed past their limits, they tend to mute the tone and emphasize the distortion.

Tubes, on the other hand, produce a more musical set of harmonics, the intensity of which can be controlled by the player. This characteristic adds warmth and definition to the sound which has become the hallmark of tube amplifiers. When tubes are driven into clipping, the harmonic overtones can be both sweet and pleasing or intense and penetrating, depending on the musician's musical taste and playing technique.

Over the years, application engineers have designed a number of outstanding solid-state amplifiers that sound very, very good. Some use special circuitry which enables them to simulate the distortion characteristics of a tube amplifier. However, the tube amplifier, still held in the highest esteem by many musicians, offers a classic "vintage" sound in a contemporary market.

Tube Types And Usage:

Tube amplifiers are based primarily on two types of tubes – preamplifier tubes and power tubes. The tubes used in preamplifiers (12AX7, 12AU7, 12AT7, etc.) are smaller than the power tubes. These tubes amplify the signal from your instrument and shape the sound. They are inherently microphonic (mechanically pick up and transmit external noises). Since these tubes are used in the critical first stages of a tube amplifier's circuitry, it is very important to use high-quality, low noise/low microphonic tubes for this application. Although tubes of this quality may be difficult to find and typically cost more than "off-the-shelf" tubes, the improvement in performance is worth the investment.

Preamplifier tubes are also used to drive the power tubes. When used in this application, a 12AX7 will produce a more distorted tone than a 12AT7, which produces a clearer, sweeter sound. A 12AU7 is even cleaner and brighter than a 12AT7, giving more definition to the sound. (In some cases it is possible to change the sound by changing the type of preamp and/or driver tubes. When making any modification to your equipment, it is highly recommended that you consult with a qualified service center.)

The power tubes are the largest tubes used in an amplifier. These tubes convert the low-level, conditioned signal from the preamplifier into a level that is sufficient to drive the speakers. There are several types of power tubes available, each of which offers a different performance/sound characteristic. For example, the EL34 power tube produces a great Classic rock sound. When an EL34 is driven into distortion it produces a unique sound ("crunch"). When compared to the 6L6, the EL34 distorts more quickly, exhibits a "looser" low-end response and produces more harmonics at mid and high frequencies ("creamier" sound). These differences become more noticeable at higher volumes.

The 6L6 tubes produce a big low-end thump and have a very good dynamic range. They offer a more traditional "American Rock" sound. The 6V6 tubes produce a creamy sound with nice distortion. On the other hand, the KT88 produces a big low-end but sounds more like an EL34 in the mid and high frequencies.

The 6550 power tubes are more rugged and stay cleaner sounding even at full power. When they do distort, the sound produced is more solid and has a tighter low end; more of a "heavy metal" type distortion with lots of power.

Some tubes are available in matched sets. These tubes have been extensively tested for optimum performance and longevity.

Important Information About Tubes And Tube Products (Continued):

The Nature Of Tubes: Why (And When) To Replace Them:

Tubes are made up of a number of fragile mechanical components that are vacuum-sealed in a glass envelope or bubble. The tube's longevity is based on a number of factors which include how hard and often the amplifier is played, vibration from the speakers, road travel, repeated set up and tear down, etc.

Any time you notice a change in your amplifier's performance, check the tubes first.

If it's been a while since the tubes were replaced and the sound from your amplifier lacks punch, fades in and out, loses highs or lows or produces unusual sounds, the power tubes probably need to be replaced. If your amplifier squeals, makes noise, loses gain, starts to hum, lacks "sensitivity", or feels as if it is working against you, the preamplifier tubes may need to be replaced.

The power tubes are subjected to considerably more stress than the preamplifier tubes. Consequently, they almost always fail/degrade first. If deteriorating power tubes aren't replaced they will ultimately fail. Depending on the failure mode, they may even cause severe damage to the audio output transformer and/or other components in the amplifier. Replacing the tubes before they fail completely has the potential to save you time, money and unwanted trouble. Since power tubes work together in an amplifier, it is crucial that they (if there is more than one) be replaced by a matched set. If you're on the road a lot, we recommend that you carry a spare matched set of replacement power tubes and their associated driver tubes.

After turning off the power and disconnecting the amplifier from the power source, carefully check the tubes (in bright light) for cracks or white spots inside the glass or any other apparent damage. Then, with the power on, view the tubes in a dark room. Look for preamplifier tubes that do not glow at all or power tubes that glow excessively red.

Whenever you replace the power tube(s):

- Always have the amplifier's bias voltage checked by a qualified service center. Improper bias voltage will cause degradation in performance and possibly damage the tubes and/or the amplifier. (See the section below entitled, "The Importance of Proper Biasing", for more information on this subject).
- We highly recommend that you replace the driver tube(s) as well. The driver tube determines the shape and amplitude of the signal applied to the power tube(s) and has to work almost as hard as the power tube(s).

You can check your preamplifier tubes for microphonics by turning the amplifier on, turning up the gain and tapping lightly on each tube with the end of a pencil or a chop stick (my favorite). You will be able to hear the tapping through your speakers, which is normal. It is not normal for a tube to ring like a bell after it's tapped. If it does ring then it's microphonic and should be replaced. Remember to use only high quality, low microphonic tubes in the preamplifier section.

Even though power tubes are rarely microphonic, you should check them anyway. The power tubes can be checked for microphonics just like pre-amp tubes.

In the case of very high gain amps, you may be able to reduce the amount of noise generated by simply swapping the preamp tubes around.

The Importance Of Proper Biasing:

For the best performance and longest tube life, proper biasing is imperative. Bias is the negative voltage which is applied to the power tube's control grid to set the level of idle current. We cannot over emphasize the difference in warmth of tone and dynamic response that come with proper biasing. If the bias is set too high (overbiased), the sound from the amp will be distorted at all levels. If the bias is set too low, (under biased) the power tubes will run hot (the plates inside the tubes may glow red due to excessive heat) and the sound from the amplifier will lack power and punch. The excessive heat greatly reduces tube life – from a few days to as little as a few hours in extreme cases. Setting the bias on your amp is like setting the idle on your car. If it's too high or hot it's running away with you and if it's too low or cold it will choke when you step on it.

The bias is adjusted at the factory in accordance with the type of power tube(s) installed in your amplifier. It is important to point out that tubes of the same type and specification typically exhibit different performance characteristics. Consequently, whenever power tubes are replaced, the bias voltage must be checked (unless the amplifier is equipped with "self-biasing circuitry") and readjusted to accommodate the operating parameters of the replacement tubes.

Depending on the model and amplifier type, there may be hum balance controls, trim pots, or bias adjustment controls on its rear panel. However, the bias adjustment should be performed only by qualified service personnel with the proper, calibrated test equipment.

Important Information About Tubes And Tube Products (Continued):**Survival Tips For Tube Amplifiers:**

To prolong tube life, observe these tips and recommendations:

- Match the impedance of your speaker cabinet(s) to your amplifier. Improper impedance matching will contribute to early tube degradation and may cause premature tube failure.
- Make sure the speaker(s) are properly connected prior to turning on the amplifier.
- After playing the amplifier, allow sufficient time for it to properly cool down prior to moving it. A properly cooled amplifier prolongs tube life due to the internal components being less susceptible to the damage caused by vibration.
- Allow the amplifier to warm up to room temperature before turning it on. The heat generated by the tube elements can crack a cold glass housing.
- Replace the output tube(s) before the performance degrades or the tubes fail completely. Replace the tube(s) on a regular basis (at least once per year or as often as every 4 to 6 months if you play long and hard every day).
- Always have the bias checked after replacing the output tubes (unless the amplifier is equipped with "self-biasing circuitry"). This should be done **ONLY** at a qualified service center. Improper biasing could result in the tubes running too hot, which greatly reduces the life of the tubes – or too cold, which results in distorted sound regardless of level settings. Do not play the amplifier if it exhibits these symptoms – get the bias checked/adjusted immediately to prevent tube failure and/or other damage.
- If the locating notch on the base of a power tube breaks off, replace the tube. This significantly reduces the risk of damaging your amplifier by incorrectly inserting the tube.
- Protect the amplifier from dust and moisture. If liquid gets into the amplifier proper, or if the amplifier is dropped or otherwise mechanically abused, have it checked out at an authorized service center before using it.
- Proper maintenance and cleaning in combination with routine checkups by your authorized service center will insure the best performance and longest life from your amplifier.

CAUTION: Tube replacement should be performed only by qualified service personnel who are familiar with the dangers of hazardous voltages that are typically present in tube circuitry.

Some Suggested Settings:

CRUNCHY EDGE:

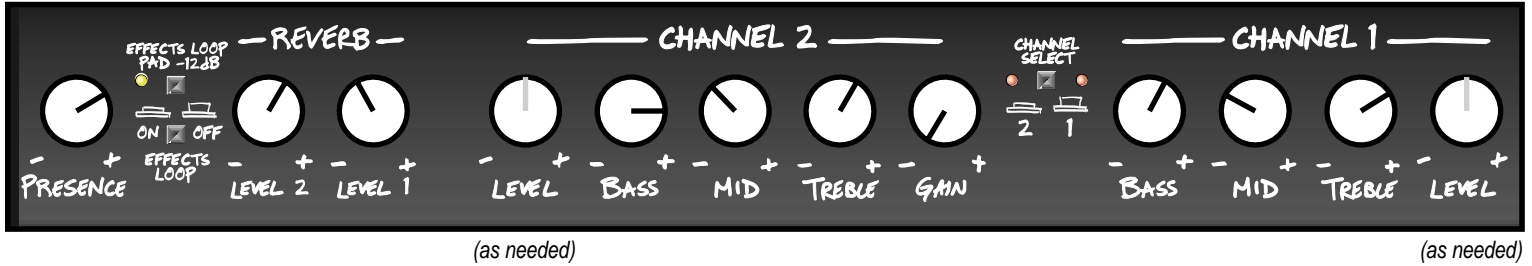

SPARKLING CLEAN:

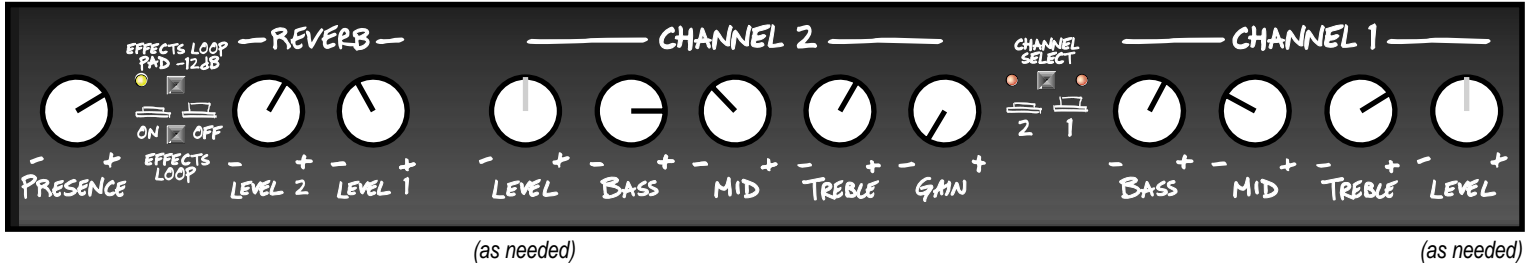

ROCK RHYTHM:

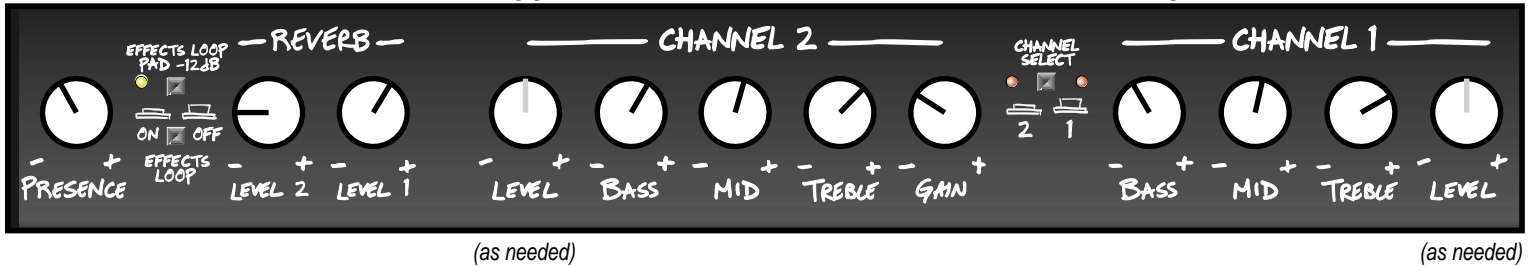

FAT CLEAN:

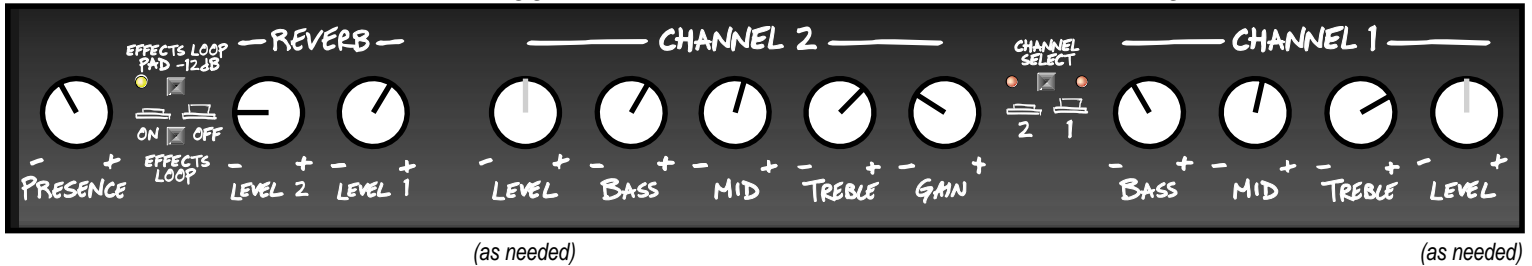

MASSIVE METAL:

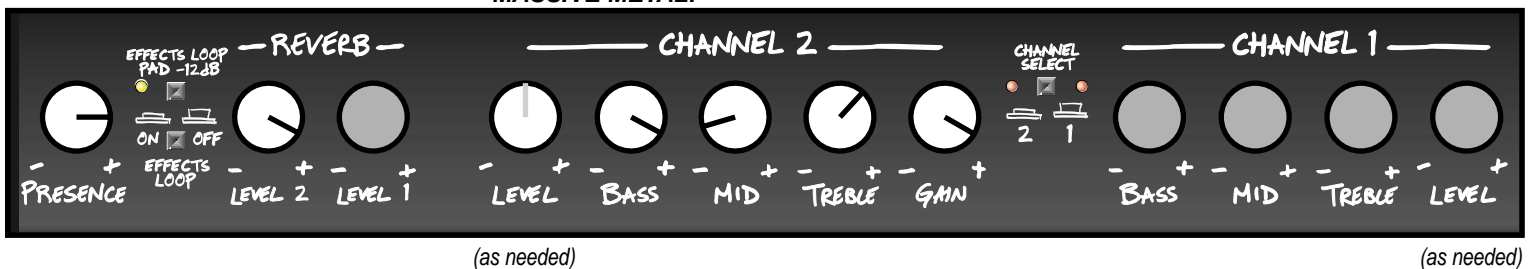

System Block Diagram:

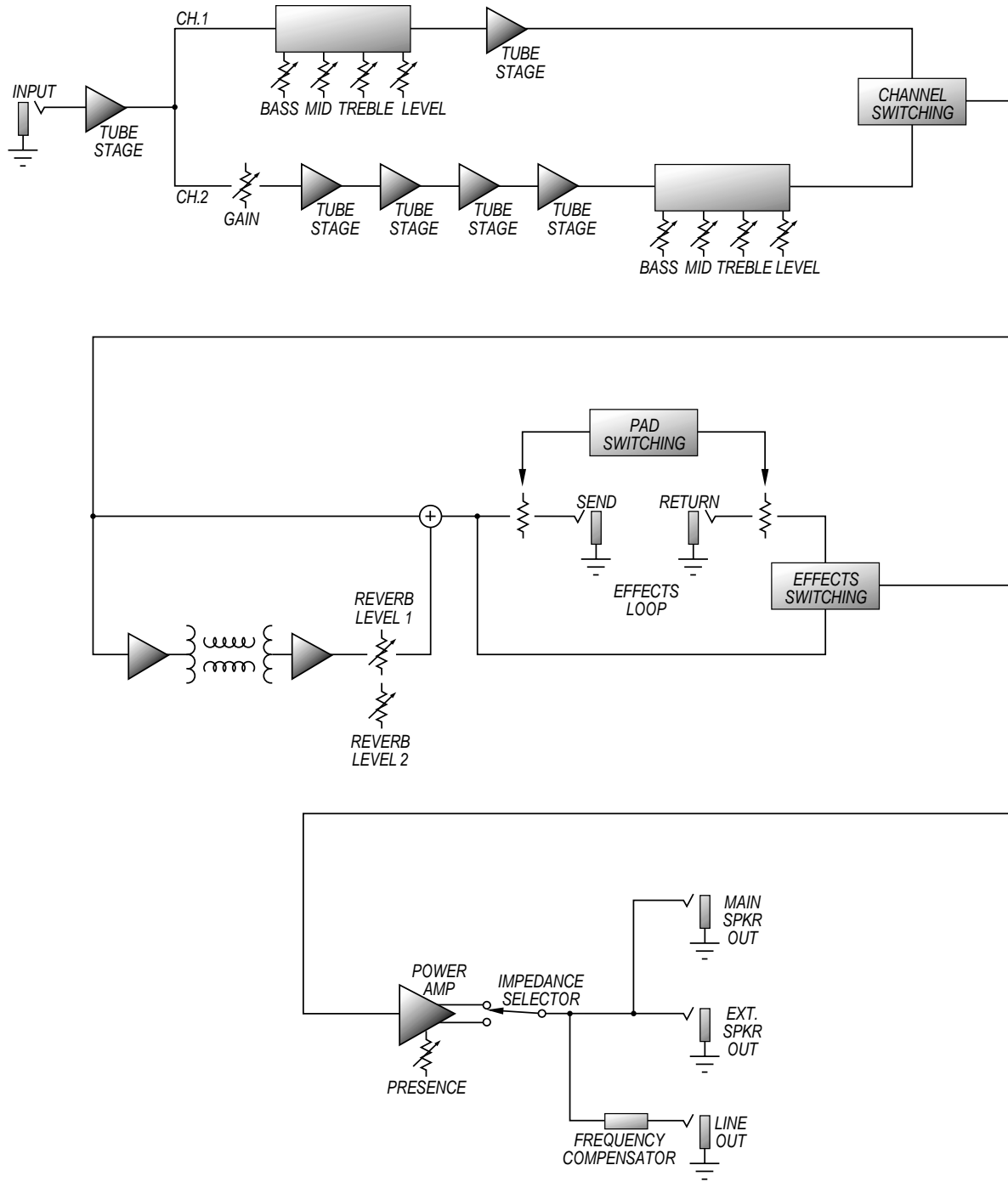



BV120H All Tube Guitar Amplifier

BV120H TECHNICAL SPECIFICATIONS:

Output Power Rating	100W RMS @ 5% THD, 8 or 16 ohm load, 120 VAC		
Gain	Channel 1	Channel 2	
	66dB, tones at "10" @ 1kHz	101dB, tones at "10" @ 1kHz	
Tone Control Range	Channel 1	Channel 2	
	Bass	16dB @ 100Hz	15dB @ 100Hz
	Mid	20dB @ 300Hz	13dB @ 500Hz
	High	10dB @ 10kHz	10dB @ 10kHz
	Presence	5dB @ 10kHz	5dB @ 10kHz
Input Impedance	1M ohm		
Maximum Signal Accepted	2.8V peak to peak		
Power Requirements	120VAC, 60Hz, 180VA		
	100/115VAC, 50/60Hz, 180VA		
	230VAC, 50/60Hz, 180VA		
SIZE AND WEIGHT	30.25"W x 12"H x 10"D, 50 lbs.		

The BV120H is covered with a durable Tolex material: wipe it clean with a lint-free cloth. Never spray cleaning agents onto the cabinet. Avoid abrasive cleansers which would damage the finish.

Crate continually develops new products, as well as improves existing ones. For this reason, the specifications and information in this manual are subject to change without notice.

Declaration Of Conformity

#35, Effective 01-01-2001

Manufacturer's Name: SLM Electronics
Production Facility: 1901 Congressional Drive, St. Louis, MO 63146, USA
Production Facility: 700 Hwy 202 W, Yellville, AR 72687, USA
Shipping Facility: 1400 Ferguson Ave., St. Louis, MO 63133, USA
Office Facility: 1400 Ferguson Ave., St. Louis, MO 63133, USA

Product Type: Audio Amplifier

Complies with the following Standards:

Safety: EN60065, E60065, C22.2, UL6500 and/or UL813
EMC: Directive 89/336/EEC, EN55103, EN55013, EN61000, and/or FCC 47CFR 15B c/a

Supplementary information provided by:
 SLM Electronics - R & D Engineering
 1901 Congressional Drive, St Louis, MO 63146, USA
 Tel.: 314-569-0141, Fax: 314-569-0175



www.crateamps.com

@ 2003 SLM Electronics, a division of St. Louis Music, Inc • 1400 Ferguson Avenue • St. Louis, MO 63133

47-631-06 • 120403

Download from Www.Somanuals.com. All Manuals Search And Download.



Free Manuals Download Website

<http://myh66.com>

<http://usermanuals.us>

<http://www.somanuals.com>

<http://www.4manuals.cc>

<http://www.manual-lib.com>

<http://www.404manual.com>

<http://www.luxmanual.com>

<http://aubethermostatmanual.com>

Golf course search by state

<http://golfingnear.com>

Email search by domain

<http://emailbydomain.com>

Auto manuals search

<http://auto.somanuals.com>

TV manuals search

<http://tv.somanuals.com>