

Operations Guide

CRATE
DX-112/212



Welcome. Please, Read This:

We at Crate extend our sincere “welcome” into a whole new world: a world where the legendary performance of a musician-made Crate amplifier combines with the wonders of digital amp modeling and effects. We bring you the only amplifier you’ll ever need: the Crate DX-112 / DX-212. The heart and soul of sixteen different amplifiers have been captured through the miracles of digital software engineering and placed into the DX amplifier. Not only does the amp *sound* like the originals, it *performs* like the originals, with the same tones and character of all your favorites – from vintage British grit to today’s heavy metal – with a wide variety in between.

Along with digital amp modeling comes sixteen digital effects, all designed to rock your world from here to Sunday. And, you can tweak each effect to your heart’s content!

Got your own favorite effects? Not to worry – the DX amps have stereo line in and line out jacks for use as a stereo effects loop, or for connecting to an external stereo power amp. It’s like having your cake and eating it, too – with extra icing!

The DX amplifier is programmable and can be controlled in a number of ways, including through the front panel keypad, with the optional Crate Foot Controller, or via MIDI.

Within the pages of this Operating Guide you will find all sorts of pertinent, useful and sometimes technical information which we at Crate felt you ought to have. Please indulge us a bit and take the time to actually read through this Guide at some point. Until then, for those of you who just can’t wait to plug in and go, we offer you:

Quick Start: Plug In and Go! (page 1)

There you’ll find just enough information to get you started. If you run into any situation that isn’t covered in the Quick Start section, you might have to – guitar gods forbid – read this guide first.

We at Crate thank you for choosing the DX-112/212 Digital Guitar Amplifier!

CRATE DX-112/212 Digital Guitar Amplifier

Important Safeguards and Precautions





All Crate products are designed for continuous safe operation, as long as common sense is used and steps are taken to help avoid certain problems. Abiding by the following rules can help prevent damage to your amplifier, yourself and others.

- The amplifier is equipped with a three-pronged AC power cord. To reduce the risk of electrical shock, **NEVER** remove or otherwise attempt to defeat the ground pin of the power cord.
- Connect the amplifier **ONLY** to a properly grounded AC outlet of the proper voltage for your pre-amp.
- Avoid sudden temperature extremes, rain and moisture. Also, avoid sudden and intense impact. (If the amplifier has been subjected to any of the preceding abuses, have it looked at by an authorized service center.)
- Unplug the amplifier before cleaning it. **NEVER** spray liquid cleaners onto the preamp. Wipe it with a slightly dampened, lint-free cloth to remove dirt and film.
- Don't use the amplifier if it has sustained damage to the chassis, controls, or power cord. Refer the unit to an authorized service center for inspection.
- **NOTE:** Amplifiers capable of producing high volume levels are also capable of inflicting permanent hearing loss or damage, if the exposure to such levels is prolonged. Such damage is progressive and irreversible! **Caution is advised and ear protection is recommended when playing at extremely loud levels.**

The chart below shows the U.S. Government Occupational Safety and Health Administration (OSHA) regulations which were in effect at the time of this publication for permissible noise exposure, per 29CRF 1910, Table G-16.

| SOUND LEVEL dBA SLOW RESPONSE | DURATION PER DAY IN HOURS | SOUND LEVEL dBA SLOW RESPONSE | DURATION PER DAY IN HOURS |
|----------------------------------|------------------------------|----------------------------------|------------------------------|
| 90 | 8 | 102 | 1-1/2 |
| 92 | 6 | 105 | 1 |
| 95 | 4 | 110 | 1/2 |
| 97 | 3 | 115 | 1/4 or less |
| 100 | 2 | | |

According to OSHA, any exposure in excess of those listed above could result in some hearing loss.

| | | |
|--|--|--|
|  <p>CAUTION RISK OF ELECTRIC SHOCK DO NOT OPEN</p> <p>CAUTION: TO REDUCE THE RISK OF ELECTRIC SHOCK, DO NOT REMOVE COVER. NO USER-SERVICEABLE PARTS INSIDE. REFER SERVICING TO QUALIFIED SERVICE PERSONNEL.</p> |  <p>ATTENTION RISQUE D'ELECTROCUTION NE PAS OUVRIR</p> <p>ATTENTION: POUR REDUIRE D'ELECTROCUTION NE PAS ENLEVER LE COUVERCLE. AUCUNE PIECE INTERNE N'EST REPARABLE PAR L'UTILISATEUR. POUR TOUTE REPARATION, S'ADRESSER A UN TECHNICIEN QUALIFIE.</p> |  <p>VORSICHT ELEKTRISCHE SCHLAGGEFAHR NICHT OFFENEN</p> <p>VORSICHT: ZUR MINIMIERUNG ELEKTRISCHER SCHLAGGEFAHR NICHT DEN DECKEL ABENHMEN. INTERNE TEILE KONNEN NICHT VOM BENUTZER GEWARTET WERDEN. DIE WARTUNG IS QUALIFIZIERTEM WARTUNGSPERSONAL ZU UBERLASSEN.</p> |
| <p>THIS EQUIPMENT HAS BEEN DESIGNED AND ENGINEERED TO PROVIDE SAFE AND RELIABLE OPERATION. IN ORDER TO PROLONG THE LIFE OF THE UNIT AND PREVENT ACCIDENTAL DAMAGES OR INJURY, PLEASE FOLLOW THESE PRECAUTIONARY GUIDELINES:</p> <p>WARNING: TO REDUCE THE RISK OF ELECTRIC SHOCK, DO NOT OPEN CHASSIS; DO NOT DEFEAT OR REMOVE THE GROUND PIN OF THE POWER CORD; CONNECT ONLY TO A PROPERLY GROUNDED AC POWER OUTLET.</p> <p>CAUTION: TO REDUCE THE RISK OF FIRE OR ELECTRIC SHOCK, DO NOT EXPOSE THIS EQUIPMENT TO RAIN OR MOISTURE.</p> <p>CAUTION: NO USER-SERVICEABLE PARTS INSIDE. REFER SERVICING TO QUALIFIED SERVICE PERSONNEL.</p> <p>CAUTION: OUR AMPLIFIERS ARE CAPABLE OF PRODUCING HIGH SOUND PRESSURE LEVELS. CONTINUED EXPOSURE TO HIGH SOUND PRESSURE LEVELS CAN CAUSE PERMANENT HEARING IMPAIRMENT OR LOSS. USER CAUTION IS ADVISED AND EAR PROTECTION IS RECOMMENDED IF UNIT IS OPERATED AT HIGH VOLUME.</p> | | |
| <p>EXPLANATION OF GRAPHICAL SYMBOLS:</p> <p> = "DANGEROUS VOLTAGE" "DANGER HAUTE TENSION" "GEFAHRLICHE SPANNUNG"</p> <p> = "IT IS NECESSARY FOR THE USER TO REFER TO THE INSTRUCTION MANUAL" "REFERREZ-VOUS AU MANUAL D'UTILISATION" "UNBEDINGT IN DER BETRIEBUNGSANLEITUNG NACHSCHLAGEN"</p> | | |

DX-112/212 Digital Guitar Amplifier **CRATE**

Contents

| | |
|---|-------------|
| <p>Quick Start: Plug In and Go!</p> <ul style="list-style-type: none"> Making Sound1 A Look at the Front Panel Controls3 A Look at the Rear Panel5 | QUICK START |
| <p>Making the Right Connections</p> <ul style="list-style-type: none"> The Input Jacks7 The Stereo Line In and Line Out Jacks7 Using a MIDI Footswitch9 Using the Crate Foot Controller9 The MIDI Out/Thru Jack9 The Stereo Headphones Jack9 | CONNECTIONS |
| <p>The Amp Models</p> <ul style="list-style-type: none"> Descriptions of the Models11 Equalization and Channel Level13 | AMP MODELS |
| <p>The Digital Effects</p> <ul style="list-style-type: none"> Descriptions of the Effects15 Effects Selection and Adjustment17 | EFFECTS |
| <p>The Keypad</p> <ul style="list-style-type: none"> Recalling The Presets19 Saving New Presets19 The Tap Button20 The Manual ("MAN") Button20 Restoring Factory Default Presets20 | THE KEYPAD |
| <p>Playing Favorites</p> <ul style="list-style-type: none"> Factory Presets 1–1021 User Presets 1–10023 | FAVORITES |
| <p>Appendices</p> <ul style="list-style-type: none"> A. Designer’s Note: Amplifier Modeling43 <ul style="list-style-type: none"> Block Diagrams44 B. MIDI Implementation Chart45 C. Specifications46 | |

CRATE DX-112/212 Digital Guitar Amplifier

QUICK START

Quick Start: Plug In and Go!

Making Sound:

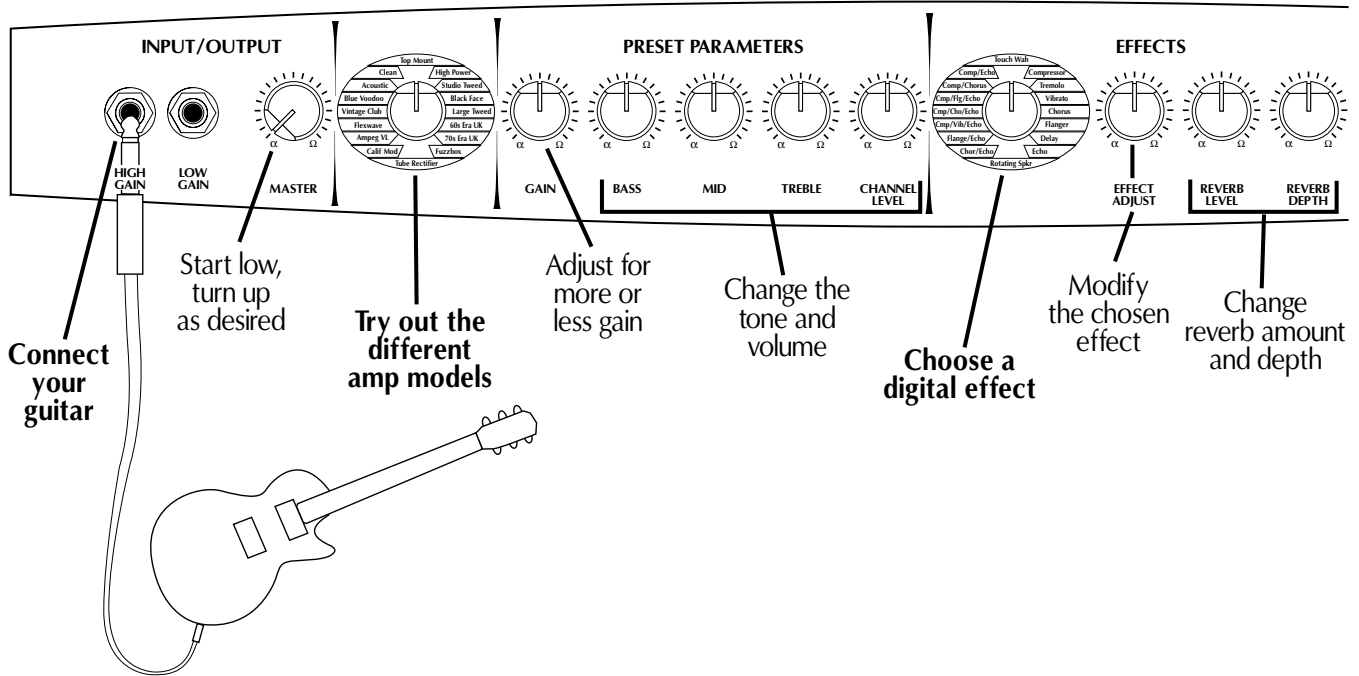

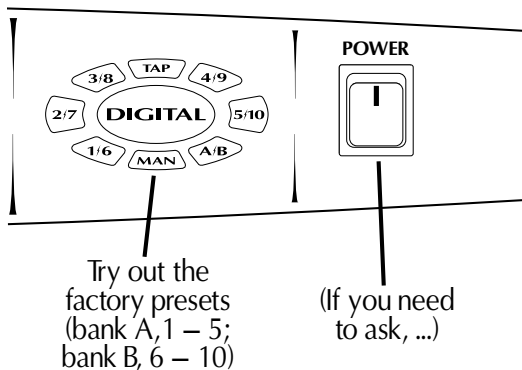

Making Sound:

- You may want to start out with the Master control turned down low, since this amp can get LOUD.
- Connect your guitar, plug in the amp and turn it on.
- Select the manual mode by pressing the MAN button on the keypad.
- Adjust the Gain control to get the amount of gain you want.
- Try out the amp models by turning the Amp Selector knob.
- Use the Bass, Mid, Treble and Channel Level controls to change the tone and volume. The EQ settings will vary depending on the amp model you choose.
- Choose a digital effect by turning the Effects Selector knob.
- Modify the chosen effect by turning the Effect Adjust control.
- Adjust the reverb by turning the Reverb Level and Depth controls.
- Try out the factory presets by pressing the numbered buttons and the A/B button on the Keypad.
 - *When first turned on, the A/B button is not lit, and the numbered buttons recall presets 1-5 (bank A). When you press the A/B button it lights up, and the numbered buttons recall presets 6-10 (bank B).*

CRATE DX-112/212 Digital Guitar Amplifier

QUICK START

Quick Start: Plug In and Go!

A Look at the Front Panel Controls:

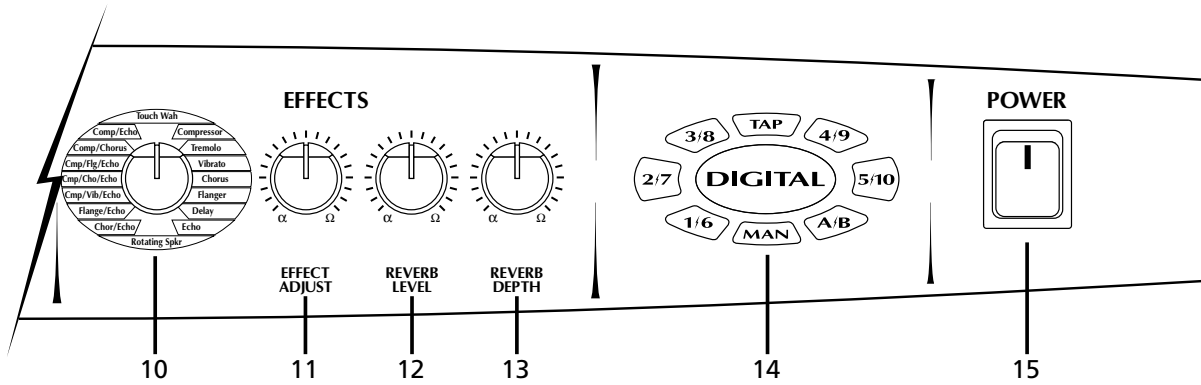
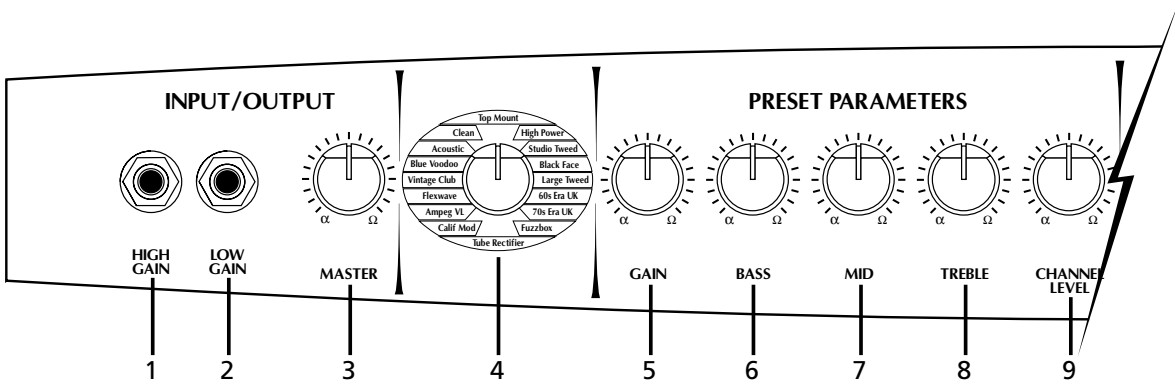

The Front Panel :

1, 2. Inputs: Use High Gain for standard pickups, Low Gain for “hot” pickups and/or on-board active electronics.

3. Master: Sets the overall output level. The Master volume is the only non-programmable setting on the amplifier.

4. Amp Selector: Chooses the desired amp model.

5. Gain: Adjusts the input gain.

6, 7, 8. Bass, Mid, Treble: Adjusts the signal tone.

9. Channel Level: Sets the output level of the current preset.

10. Effects Selector: Chooses the effect applied to the signal.

11. Effects Adjust: Changes one or more parameter of the current effect.

12. Reverb Level: Sets the amount of reverberation applied to the signal.

13. Reverb Depth: Changes the depth and high-frequency damping of reverberation, from a very small room (fully counter-clockwise) to a very large hall (fully clockwise).

14. Keypad: Recalls and saves presets, using the numbered buttons and the A/B button.

15. Power: Up is on!

Refer to Section / Page:

“The Input Jacks” – page 7,8

“Descriptions of the Models” – page 11,12

“Equalization and Channel Level” – page 13,14

“Equalization and Channel Level” – page 13,14

“Equalization and Channel Level” – page 13

“Descriptions of the Effects” – page 15,16

“Effects Selection and Adjustment” – page 17,18

“Description of the Effects” – page 15,16

“The Keypad” – page 19,20

(These are the barest of the bare-bones descriptions – enough to get you started. Please check out the sections and pages noted for more information – this goes for the rear panel, too.)

CRATE DX-112/212 Digital Guitar Amplifier

QUICK START

Quick Start: Plug In and Go!

A Look at the Rear Panel:

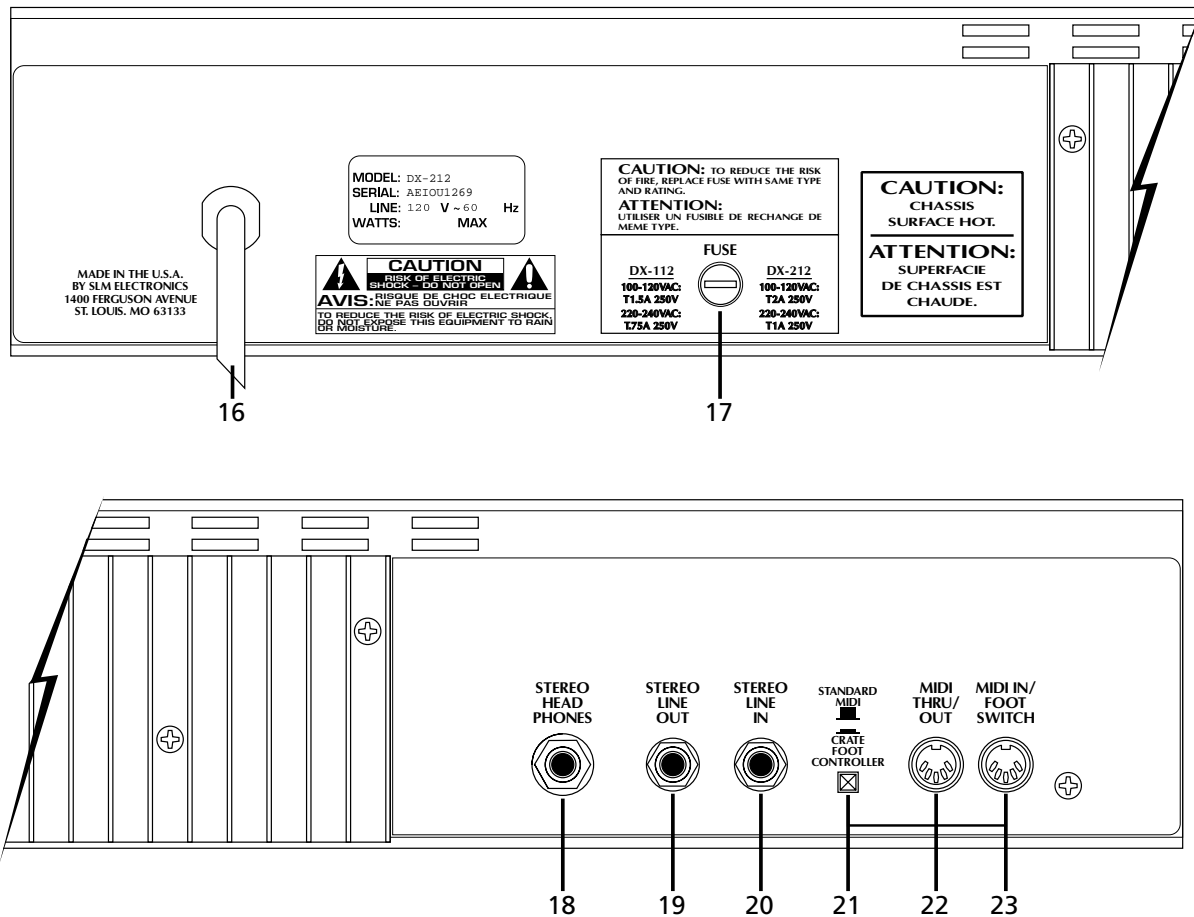

The Rear Panel :

16. AC Line Cord: Plug the male end of this cord into a properly grounded AC outlet of the correct voltage. **DO NOT DEFEAT THE GROUND PIN OF THE AC PLUG!**

17. Fuse: The fuse protects the amplifier against damages caused by overload conditions in the unit. If the fuse blows, replace it only with the same size and type as indicated on the rear panel.

18. Stereo Headphones: For those private moments, plug a pair of stereo headphones into this jack. The internal speaker(s) is (are) muted when headphones are used. (Can also be used for recording.)

19. Stereo Line Out: Connect this output to a stereo amplifier or effects unit.

20. Stereo Line In: Connect the output of an external effects unit here.

21. Standard MIDI/Crate Footswitch Controller: This switch lets you choose how you control your DX-112/212 – via MIDI or with the optional Crate Foot Controller.

22. MIDI Thru/Out: Connect to another MIDI device you wish to control with the foot controller.

23. MIDI In/Foot Switch: This jack either accepts a standard MIDI input or lets you use the Crate Foot Controller.

Refer to Section / Page:

“Stereo Headphones Jack” – page 9,10

“The Stereo Line In and Line Out Jacks” – page 7,8

“The Stereo Line In and Line Out Jacks” – page 7,8

“Using the Crate Foot Controller” – page 9,10

“The MIDI Thru/Out Jack” – page 9,10

“Using a MIDI Footswitch” – page 9,10

(That's all we're gonna give you for now! To learn a whole lot more, read the rest of this guide!)

CRATE DX-112/212 Digital Guitar Amplifier

Making the Right Connections

The Input Jacks:

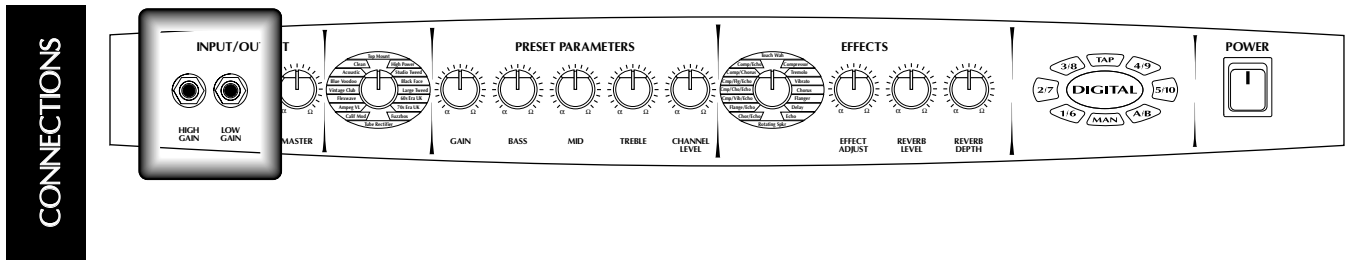

The Stereo Line In and Line Out Jacks:

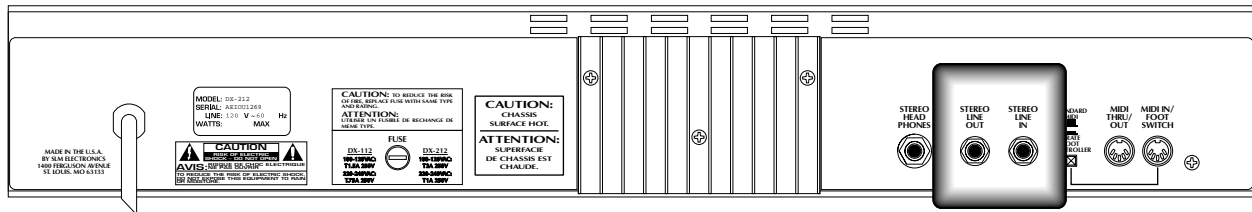

DX-112/212 Digital Guitar Amplifier **CRATE**

The Input Jacks:

The DX-112/212 has two input jacks – High Gain (straight) and Low Gain (padded) – to accommodate a wide range of pickups and playing styles. The jack you use depends on your type of pickups and the sounds you’re after.

For example, most players will plug their guitars into the High Gain jack. These players include those with “normal output” pickups and some players with “hot” pickups who are looking for some added distortion.

Some players will choose the Low Gain jack. These players are mostly those with “hot”/active pickups who want a cleaner sound, with more headroom for the Gain control.

When nothing is plugged into either jack, the DX-112/212 mutes its internal speaker(s).

The Stereo Line Out/In Jacks:

The DX-112/212 has a Stereo Line In and Line Out jack (rear panel), for use as a stereo effects loop, or to send a preamplified signal to an external stereo power amp.

To use an effects loop, connect the Line Out jack to the input of the effects device, then connect the output of the device to the Line In jack.

To send a preamplified signal, connect a stereo signal cable from the Line Out jack to the input of the stereo power amplifier.

The jacks are wired as follows: TIP = left channel, RING = right channel, SLEEVE = ground.

The Line Out jack signal is post master, post eq, and post effects.

•If you want to connect a DX-112 to another guitar amplifier for stereo sound, you’ll need to make a custom patch cable like the one shown to the right. Use this cable to connect your DX-112 Line Out jack to the Line In jack of the second guitar amp AND the DX-112 Line In jack.

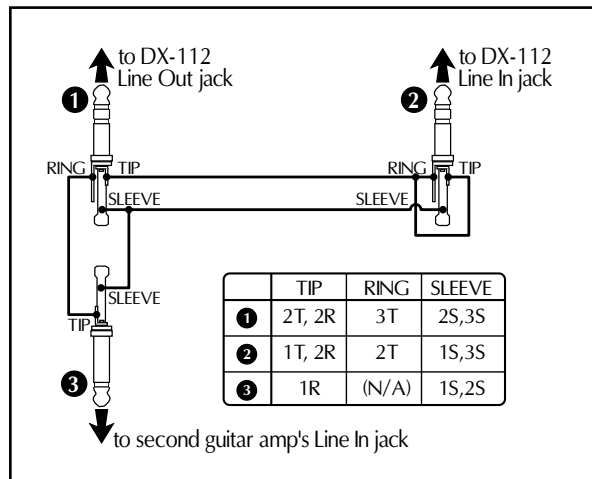

CRATE DX-112/212 Digital Guitar Amplifier

Making the Right Connections

Using a MIDI Footswitch:

CONNECTIONS

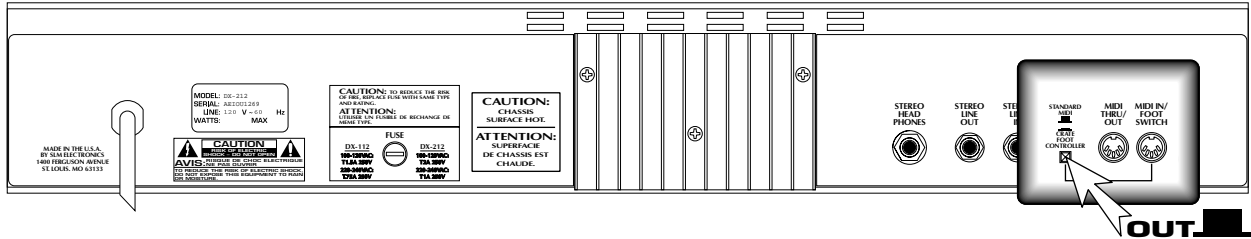

Using the Crate Foot Controller:

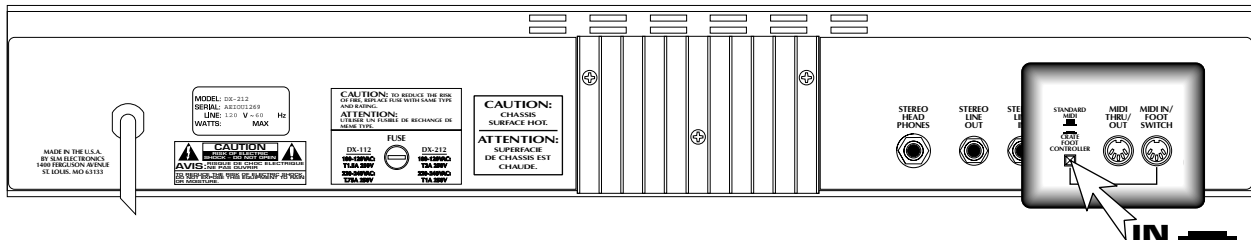

The MIDI Thru/Out Jack:

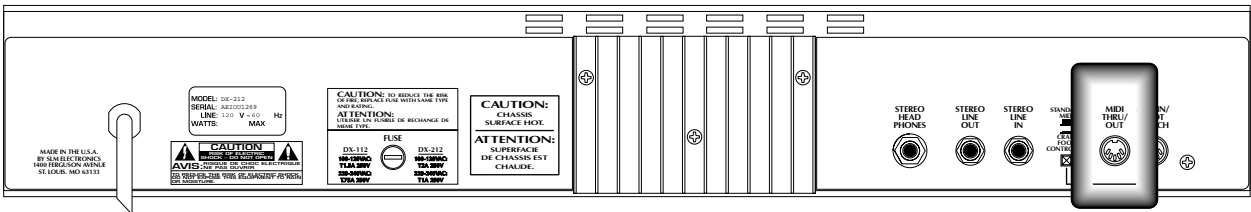

The Stereo Headphones Jack:

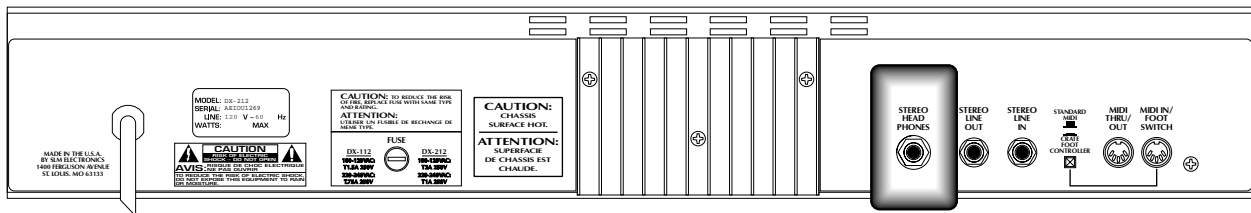

DX-112/212 Digital Guitar Amplifier **CRATE**

Using a MIDI Footswitch:

You can store and recall a total of 100 presets when using a MIDI footswitch. These presets are accessed by MIDI program numbers 0 through 99. (Also, see the MIDI Implementation Chart, Appendix B, page 45.)

WARNING: The MIDI In/Crate Foot Controller button must be in the OUT position for MIDI operation. (The IN position applies power to the Crate Foot Controller which could cause damage to another type of MIDI footswitch.)

CONNECTIONS

Using the Crate Foot Controller:

The optional Crate Foot Controller (model DX-FC) lets you store and recall a total of 100 presets and allows foot control of the tap tempo function. The controller gets its power straight from the amplifier, so no external power source or batteries are needed!

Plug the connecting cable into the MIDI In/Foot Switch jack and set the MIDI In/Crate Foot Controller button to the IN (foot controller) position. This applies the power needed for the Crate Foot Controller. (See the Foot Controller's User's Guide for more complete information-when you get one!)

The MIDI Thru/Out Jack:

The MIDI Out/Thru jack lets you control other MIDI devices with the Foot Controller. Connect this jack to the MIDI In jack of the device you wish to control.

The MIDI Thru works with either a standard MIDI input (footswitch) or with the Crate Foot Controller plugged into the MIDI In jack, since the Crate Foot Controller sends standard MIDI messages.

The Stereo Headphones Jack:

Plug a pair of stereo headphones into this jack, for private listening. The internal speaker(s) is (are) disconnected when headphones are used. The headphones signal is speaker compensated for a realistic sound even without a guitar speaker cabinet. Since this amp can play LOUD, be careful when using headphones – prolonged exposure to those high dB levels can wreak havoc on your eardrums!

- The Headphones Jack can also be used as a stereo direct out for recording.

CRATE DX-112/212 Digital Guitar Amplifier

The Amp Models

Description of the Models:

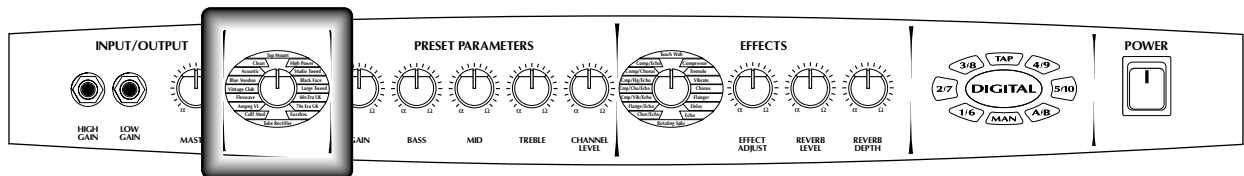

AMP MODELS

The DX-112/212 is actually 16 different amplifiers in one! The software inside the amplifier convinces the signal that it's going through the electronic components of the original amplifier, giving it all of the characteristics of that amp! (More or less – it's really a lot more technical than that, but you get the picture. For a slightly more technical description, see Appendix A on page 43.)

Use the amp selector knob to choose which amp model you want. The chart on the following page lists the name we gave the amp model, the “make and model” of the amp we emulated, and a brief description of the original amp.

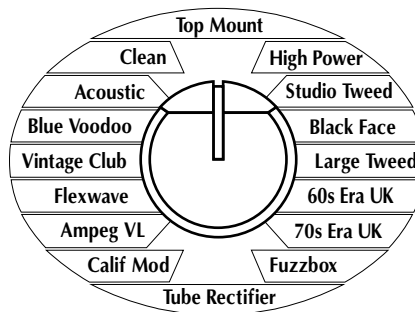

DX-112/212 Digital Guitar Amplifier **CRATE**

| Model Name | Modeled After the... | Brief Description |
|-----------------------|------------------------------|--|
| Top Mount | Vox AC 30 | Bright with a great clean sound at low gain, distorts smoothly at high gain settings – an early 60's amp with lots of 2nd and 3rd order harmonics, favored by the Beatles for the rhythm and lead tracks in their early days |
| High Power | Hi Watt DR | An early 60's "upmarket" alternative to the popular Marshall amp – louder and cleaner than most |
| Studio Tweed | Fender Deluxe 5E3 | The sound from which Rock 'n' Roll was born – Fender's early 50's claim to fame |
| Black Face | Fender Deluxe Reverb AA763 | <i>The classic tube amp</i> – one of the first amps with reverb, a mid-60's staple to the rock and roll diet (considered by some to be one of the best amps ever made) |
| Large Tweed | Fender Bassman 5F6-A | Originally designed for bass, favored by guitarists for its big sound – a late 50's classic |
| 60s Era UK | Marshall 1959 | The renowned "brown sound" – a softer, smoother Marshall than the more modern creations |
| 70s Era UK | Marshall JCM 800 | The sound of ROCK! – loud and powerful with a definitive edge |
| Fuzzbox | Dallas-Arbiter Fuzz Face | Jimi would be proud – the classic stomp box distortion of his day |
| Tube Rectifier | Mesa-Boogie Dual Rectifier | Barre chord Heaven – the beginning of the modern high-gain amp era |
| Calif Mod | Mesa-Boogie Mark IIC+ | Tons of overdrive and sustain; the sound of Santana! – the hot-rodded powerhouse Simul-Class amplifier |
| Ampeg VL | Ampeg VL-501 | A hot-rodded Marshall-style amp – powerful, lots of distortion and multiple gain stages |
| Flexwave | Crate GX-140C | The massively overdriven, solid state Crate sound preferred by Metal-Heads everywhere – a solid-state competitor for most classic tube amps due to Crate's proprietary FlexWave circuitry |
| Vintage Club | Crate VC-60 | A unique combination of both modern high-gain and classic tube amps – bringing back the "vintage" sound of the early days of rock |
| Blue Voodoo | Crate BV-60 | Awesome modern high-gain tone – smooth, clean, and powerful |
| Acoustic | Boss AC-1 Acoustic Simulator | Makes your electric guitar sound like an acoustic |
| Clean | Crate GX-140C | Clean Jazz sound – just enough of an edge to get your message across |

All-important, legal, "cover-our-rear-ends" blurb!

Vox, Hi Watt, Fender, Marshall, Dallas-Arbiter, Mesa-Boogie, Boss, and the names of their respective products are all trademarks of their respective companies, and have no affiliation with Crate and/or SLM Electronics, or with the DX-112/212 amplifier. These companies and their products are acknowledged herein because we listened to their stuff and modeled some of their sounds into our amplifier. Also, the above descriptions are paraphrased synopses of many of our own experiences with the amplifiers, along with information from the "The Tube Amp Book, 4th Edition."

CRATE DX-112/212 Digital Guitar Amplifier

The Amp Models

Equalization and Channel Level:

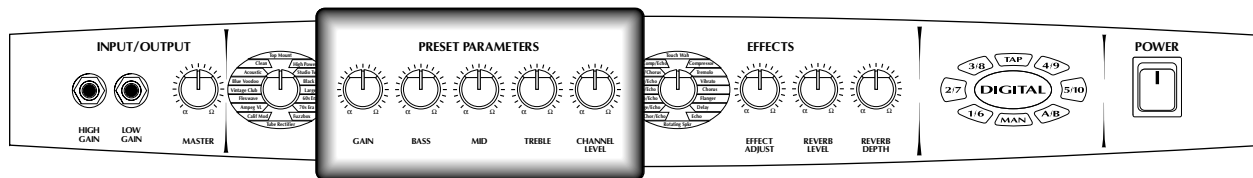

AMP MODELS

Each DX-112/212 amp model has its own specifications and placement in the signal chain for its Gain, Bass, Mid, and Treble. (In other words, the controls affect the signal the same in the amp model as they do on the original amplifier.)

Use the Preset Parameter controls (Gain, Bass, Mid, Treble, Channel Level) to change the gain, eq and volume of the selected amp model. The chart on the following page lists the model name and the specifications/placement for the Drive and EQ controls.

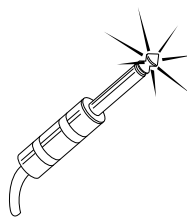

TIP! When using the Acoustic or Clean amp models, set the Channel Level to maximum and use the Gain control for your volume level.

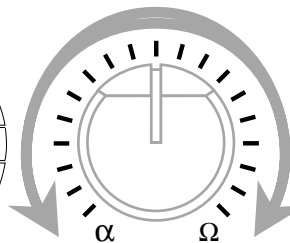
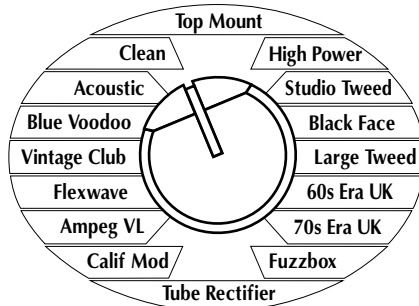

GAIN
(Use as volume control)

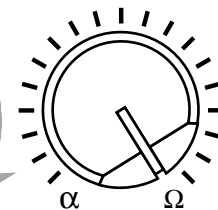

CHANNEL LEVEL

DX-112/212 Digital Guitar Amplifier **CRATE**

| Name | Amplifier Modeled | Simplified Representation of EQ Position in Signal Chain |
|----------------|------------------------------|--|
| Top Mount | Vox AC 30 | GAIN → EQ → GAIN |
| High Power | Hi Watt DR | GAIN → EQ → GAIN |
| Studio Tweed | Fender Deluxe 5E3 | EQ (TREBLE) → GAIN → EQ (MID/BASS) |
| Black Face | Fender Deluxe Reverb AA763 | EQ → GAIN → GAIN |
| Large Tweed | Fender Bassman 5F6-A | GAIN → EQ → GAIN |
| 60s Era UK | Marshall 1959 | GAIN → EQ → GAIN |
| 70s ERA UK | Marshall JCM 800 | GAIN → GAIN → EQ |
| Fuzzbox | Dallas-Arbiter Fuzz Face | GAIN → EQ |
| Tube Rectifier | Mesa-Boogie Dual Rectifier | GAIN → GAIN → EQ |
| Calif Mod | Mesa-Boogie Mark IIC+ | EQ → GAIN → GAIN |
| Ampeg VL | Ampeg VL-501 | GAIN → GAIN → EQ |
| Flexwave | Crate GX-140C | GAIN → EQ |
| Vintage Club | Crate VC-60 | GAIN → GAIN → EQ |
| Blue Voodoo | Crate BV-60 | GAIN → GAIN → EQ |
| Acoustic | Boss AC-1 Acoustic Simulator | EQ → GAIN |
| Clean | Crate GX-140C | EQ → GAIN |

AMP MODELS

All-important, legal, “cover-our-rear-ends” blurb! Again!
 Vox, Hi Watt, Fender, Marshall, Dallas-Arbiter, Mesa-Boogie, Boss, and the names of their respective products are all trademarks of their respective companies, and have no affiliation with Crate and/or SLM Electronics, or with the DX-112/212 amplifier. These companies and their products are acknowledged herein because we listened to their stuff and modeled some of their sounds into our amplifier.

CRATE DX-112/212 Digital Guitar Amplifier

The Digital Effects

Description of the Effects:

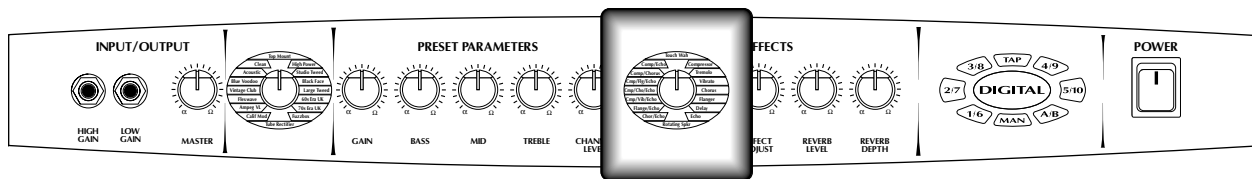

The DX-112/212 has 16 built-in digital effects, each with one or more adjustable parameters. The chart on the following page lists the name of the effect and gives a brief description.

EFFECTS

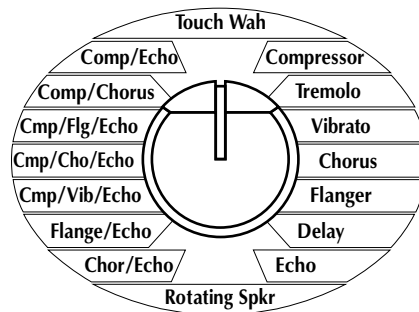

NOTE: The DX-112/212 has built-in noise reduction to ensure a more quiet operation. This circuit is always active when the amp is on.

DX-112/212 Digital Guitar Amplifier **CRATE**

| Effect | Stereo? | Description |
|---|---------|--|
| Touch Wah | | Functions as an Auto-Wah (Touch Wah) or normal wah-wah when used with an expression pedal and the optional Crate Foot Controller |
| Compressor | | Limits the dynamic range of the signal – increases the apparent sustain of the signal (applied pre-amplifier model) |
| Tremolo | | Modulates the amplitude of the signal |
| Vibrato | | Modulates the pitch of the signal |
| Chorus | Yes | Thickens the original signal with slowly pitch-modulated and delayed versions of the original signal |
| Flanger | | Adds a slowly time-varying version of the original signal |
| Delay | | Adds a delayed version of the signal |
| Echo | | Adds a delayed signal with regeneration |
| Rotating Speaker | Yes | Reproduces the classic sound of a Leslie rotating speaker |
| Chorus/Echo | Yes | A combination of chorus and echo |
| Flange/Echo | | A combination of flange and echo |
| Compressor/Vibrato/Echo | | A combination of compressor (pre-amplifier model) and vibrato and echo (post-amplifier model) |
| Compressor/Chorus/Echo | Yes | A combination of compressor (pre-amplifier model) and chorus and echo (post-amplifier model) |
| Compressor/Flange/Echo | | A combination of compressor (pre-amplifier model) and flange and echo (post-amplifier model) |
| Compressor/Chorus | Yes | A combination of compressor (pre-amplifier model) and chorus (post-amplifier model) |
| Compressor/Echo | | A combination of compressor (pre-amplifier model) and echo (post-amplifier model) |
| Reverb Level and Depth (separate from the Effects Selector knob) | Yes | Reproduces the sound of a reverberant room |

Yet another important legal blurb!

Leslie is a registered trademark of Hammond Suzuki USA, Inc.

CRATE DX-112/212 Digital Guitar Amplifier

The Digital Effects

Effects Selection and Adjustment:

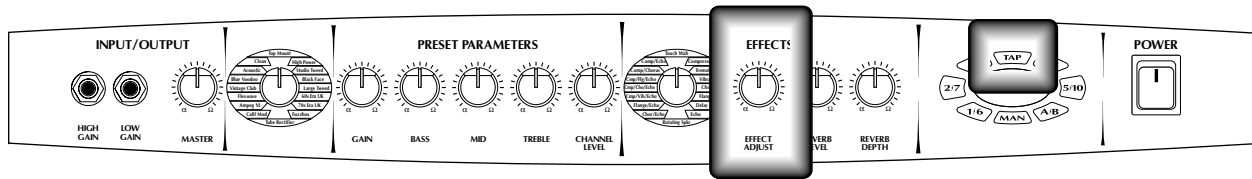

Each of the digital effects has one or more parameters you can change by using the Effects Adjust control. All of the effects (except the compressor and the Touch Wah) can also be changed by using the Tap function – either through the Keypad, or with the Crate Foot Controller. The chart on the following page lists the effects along with the parameter(s) affected by the Effects Adjust knob and the Tap button.

EFFECTS

NOTE: On multi-effects, modulation speed and echo time are set simultaneously by the Tap button.

- To bypass effects, turn the Effect Adjust control fully counter-clockwise and select the Compressor effect. (Notice the chart on page 18: There is no compression with the Effect Adjust knob full counter-clockwise, therefore no effects are applied to the signal – thus, “effects bypass.”)

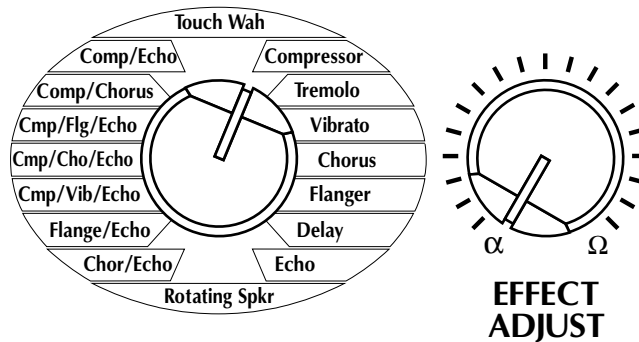

DX-112/212 Digital Guitar Amplifier **CRATE**

| Effect | Effect Adjust knob controls: | Tap button controls: | See Note(s) |
|--------------------------------|----------------------------------|--|-------------|
| Touch Wah | Sensitivity (Auto-Wah only) | --- | |
| Compressor | Ratio (See Below*) | --- | |
| Tremolo | Depth of Amplitude Modulation | Speed: 2 cycles/tap | |
| Vibrato | Depth of Pitch Modulation | Speed: 2 cycles/tap | |
| Chorus | Level of Chorused Signal | Speed: 1 cycles/tap | |
| Flanger | Max. Time Delay: 0–5ms | Speed: 1/4 cycle/tap | 1 |
| Delay | Level of Delayed Signal | Time: .033–1.12 sec | 2 |
| Echo | Regeneration | Time: .033–1.12 sec | 2 |
| Rotating Speaker | Depth of Amplitude/Pitch Mod'n | Speed: 2 cycles/tap | |
| Chorus/Echo | Chorus Level, Echo Regeneration | Chorus Speed: 1 cycle/tap, Echo Time: .033-1.12 sec | 2 |
| Flange/Echo | Echo Regeneration | Flange Speed: 1/4 cycle/tap, Echo Time: .033-1.12 sec | 1,2 |
| Compressor/Vibrato/Echo | Vibrato Depth, Echo Regeneration | Vibrato Speed: 2 cycles/tap, Echo Time: .033-1.12 sec | 2,3 |
| Compressor/Chorus/Echo | Chorus Level, Echo Regeneration | Chorus Speed: 1 cycle/tap, Echo Time: .033-1.12 sec | 2,3 |
| Compressor/Flange/Echo | Echo Regeneration | Flange Speed: 1/4 cycle/tap, Echo Time: .033-1.12 sec | 1,2,3 |
| Compressor/Chorus | Chorus Level | Chorus Speed: 1 cycle/tap | 2,3 |
| Compressor/Echo | Echo Regeneration | Echo Time: .033-1.12 sec | 2,3 |

Note 1: Mix fixed at 50%

Note 2: Tap periods exceeding 1.12 seconds are automatically adjusted to an allowable echo/delay time that fits the current tempo

Note 3: Compression ratio fixed at 10:1

* The table to the right shows how the Effect Adjust control changes the compression ratio when the Compressor ONLY is chosen.

| approx rotation of Effect Adjust control (%) | compression ratio |
|--|----------------------|
| 0 | 1:1 (no compression) |
| 30 | 2:1 |
| 40 | 3:1 |
| 50 | 4:1 |
| 60 | 6:1 |
| 70 | 10:1 |
| 80 | 20:1 |
| 90 | 100:1 |
| 100 | ∞:1 |

CRATE DX-112/212 Digital Guitar Amplifier

The Keypad

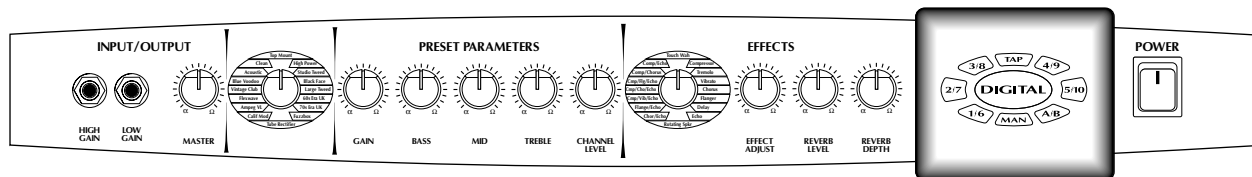

The DX-112/212's Keypad has many uses – aside from recalling presets (as mentioned in the QuickStart part of this guide):

Recalling the Presets:

There are ten presets accessible from the keypad, in two banks of five per bank: with the A/B button off (not lit), the numbered buttons to recall presets 1–5 (bank A); with the A/B button lit, the buttons recall presets 6–10 (bank B). Each preset stores its own set of parameters (amp selection, tones, level, effect, etc.). Once a preset is selected, turning a knob will change that knob's setting only – the other settings will electronically remain at their virtual positions until you change them.



“What’s a virtual position?” (Good Question!) It’s the setting that the amp remembers for each knob when a preset is stored. Example: Let’s say the Gain control was at 10:00 when preset 1 was saved, then changed to the 3:00 position. The actual setting for the knob is 3:00. Recall preset 1 and even though the knob is physically pointing to 3:00, the amp acts as if the knob were set to the 10:00 position – because that’s the virtual position for that knob in preset 1. (Got it?)

Saving New Presets:

Once you get a sound setting you want to keep, assigning it to a preset button is easy: press and hold the desired button (1–5, bank A; 6–10, bank B) until the keypad flashes (about 3 seconds). The settings are now stored at that preset location.

(NOTE: The charts on pages 23 through 42 give you a place to record the settings for your presets. Presets 1–10 are accessible through the keypad, presets 11–100 are accessible by use of the optional Crate Footswitch Controller)

The Tap Button:

The Tap button lets you match the delay time and modulation speeds of the effects (except for the compressor, which has no delay or modulation) to the tempo of the piece you're playing. Just tap your finger in time to the beat, on the Tap button of course, and the selected effect will change accordingly. The Tap button flashes in time with its tempo.

(NOTE: The chart on page 18 lists specifically what the Tap button controls for each effect setting.)

The Manual ("MAN") Button:

When you call up a preset, the preset remembers how the controls were set when the preset was stored (their virtual positions), and basically ignores their current settings. Pressing the Manual button makes the amp pay attention to the actual positions of the controls and applies their settings to the sound.

Another function of the Manual button:

- **Restoring Factory Default Presets:** To restore the presets to their original factory settings, press and hold the Manual button and button #5 until the keypad flashes (about 3 seconds). Then turn the amp off, wait five seconds, and turn it back on. The presets are now restored to the original factory settings.

WARNING! Restoring the factory presets wipes out any and all changes you've made and any new presets you've stored, so use it carefully.

Other things you should know about the lit buttons:

- As soon as you change any of the controls (except for the Master volume), the preset button starts flashing. That's its way of saying "Hey! You've changed me!" A tap on the flashing button returns the preset to its original parameters – and makes the button stop flashing. Of course, you can save the changes, as described under "Saving New Presets" on the facing page.
- When you change banks, the preset button will go out as soon as you press the A/B button, but no other changes are made until another numbered button is pressed. In other words, although there is a *visual* change, the amp won't store the preset or switch to a different one (depending on how long you press the numbered button) until you want it to.

CRATE DX-112/212 Digital Guitar Amplifier

FACTORY PRESETS 1-5 - BANK A (A/B BUTTON NOT LIT)

These two pages show the first ten factory presets for your DX-112/212 amplifier. Use the numbered buttons and the A/B button on the keypad to access them. (The following pages provide you with charts for your favorite presets.)

Preset # 1 We call it: *"Unplugged"* TAP = N/A beats/minute

| | | | | | | | | | | | | | | | | | | | | | | | | | | | | | | | | | | | | | | | |
|----------------|--------------------------|--------------------------|--------------------------|--------------------------|-----------|--------------------------|--|-----------|--------------------------|-----------|--------------------------|-------------|--------------------------|------------|--------------------------|--------------|--------------------------|---------|--------------------------|--------------|--------------------------|---------|--------------------------|--------------|--------------------------|--------|--------------------------|-------------|--------------------------|---------|--------------------------|-----------|--------------------------|-------|--------------------------|---------------|--------------------------|------|--------------------------|
| | AMP MODEL: | | Clean | <input type="checkbox"/> | Top Mount | <input type="checkbox"/> | EFFECT: <table border="1"> <tr><td>Comp/Echo</td><td><input type="checkbox"/></td><td>Touch Wah</td><td><input type="checkbox"/></td></tr> <tr><td>Comp/Chorus</td><td><input type="checkbox"/></td><td>Compressor</td><td><input type="checkbox"/></td></tr> <tr><td>Cmp/Flg/Echo</td><td><input type="checkbox"/></td><td>Tremolo</td><td><input type="checkbox"/></td></tr> <tr><td>Cmp/Cho/Echo</td><td><input type="checkbox"/></td><td>Vibrato</td><td><input type="checkbox"/></td></tr> <tr><td>Cmp/Vib/Echo</td><td><input type="checkbox"/></td><td>Chorus</td><td><input type="checkbox"/></td></tr> <tr><td>Flange/Echo</td><td><input type="checkbox"/></td><td>Flanger</td><td><input type="checkbox"/></td></tr> <tr><td>Chor/Echo</td><td><input type="checkbox"/></td><td>Delay</td><td><input type="checkbox"/></td></tr> <tr><td>Rotating Spkr</td><td><input type="checkbox"/></td><td>Echo</td><td><input type="checkbox"/></td></tr> </table> | Comp/Echo | <input type="checkbox"/> | Touch Wah | <input type="checkbox"/> | Comp/Chorus | <input type="checkbox"/> | Compressor | <input type="checkbox"/> | Cmp/Flg/Echo | <input type="checkbox"/> | Tremolo | <input type="checkbox"/> | Cmp/Cho/Echo | <input type="checkbox"/> | Vibrato | <input type="checkbox"/> | Cmp/Vib/Echo | <input type="checkbox"/> | Chorus | <input type="checkbox"/> | Flange/Echo | <input type="checkbox"/> | Flanger | <input type="checkbox"/> | Chor/Echo | <input type="checkbox"/> | Delay | <input type="checkbox"/> | Rotating Spkr | <input type="checkbox"/> | Echo | <input type="checkbox"/> |
| | Comp/Echo | <input type="checkbox"/> | Touch Wah | <input type="checkbox"/> | | | | | | | | | | | | | | | | | | | | | | | | | | | | | | | | | | | |
| | Comp/Chorus | <input type="checkbox"/> | Compressor | <input type="checkbox"/> | | | | | | | | | | | | | | | | | | | | | | | | | | | | | | | | | | | |
| | Cmp/Flg/Echo | <input type="checkbox"/> | Tremolo | <input type="checkbox"/> | | | | | | | | | | | | | | | | | | | | | | | | | | | | | | | | | | | |
| | Cmp/Cho/Echo | <input type="checkbox"/> | Vibrato | <input type="checkbox"/> | | | | | | | | | | | | | | | | | | | | | | | | | | | | | | | | | | | |
| | Cmp/Vib/Echo | <input type="checkbox"/> | Chorus | <input type="checkbox"/> | | | | | | | | | | | | | | | | | | | | | | | | | | | | | | | | | | | |
| | Flange/Echo | <input type="checkbox"/> | Flanger | <input type="checkbox"/> | | | | | | | | | | | | | | | | | | | | | | | | | | | | | | | | | | | |
| | Chor/Echo | <input type="checkbox"/> | Delay | <input type="checkbox"/> | | | | | | | | | | | | | | | | | | | | | | | | | | | | | | | | | | | |
| Rotating Spkr | <input type="checkbox"/> | Echo | <input type="checkbox"/> | | | | | | | | | | | | | | | | | | | | | | | | | | | | | | | | | | | | |
| Acoustic | <input type="checkbox"/> | High Power | <input type="checkbox"/> | | | | | | | | | | | | | | | | | | | | | | | | | | | | | | | | | | | | |
| Blue Voodoo | <input type="checkbox"/> | Studio Tweed | <input type="checkbox"/> | | | | | | | | | | | | | | | | | | | | | | | | | | | | | | | | | | | | |
| Vintage Club | <input type="checkbox"/> | Black Face | <input type="checkbox"/> | | | | | | | | | | | | | | | | | | | | | | | | | | | | | | | | | | | | |
| Flexwave | <input type="checkbox"/> | Large Tweed | <input type="checkbox"/> | | | | | | | | | | | | | | | | | | | | | | | | | | | | | | | | | | | | |
| Ampeg VL | <input type="checkbox"/> | 60s Era UK | <input type="checkbox"/> | | | | | | | | | | | | | | | | | | | | | | | | | | | | | | | | | | | | |
| Calif Mod | <input type="checkbox"/> | 70s Era UK | <input type="checkbox"/> | | | | | | | | | | | | | | | | | | | | | | | | | | | | | | | | | | | | |
| Tube Rectifier | <input type="checkbox"/> | Fuzzbox | <input type="checkbox"/> | | | | | | | | | | | | | | | | | | | | | | | | | | | | | | | | | | | | |

| | | | | | | | |
|------|------|-----|--------|---------------|---------------|--------------|--------------|
| | | | | | | | |
| GAIN | BASS | MID | TREBLE | CHANNEL LEVEL | EFFECT ADJUST | REVERB LEVEL | REVERB DEPTH |

Preset # 2 We call it: *"60's Rock"* TAP = 102 beats/minute

| | | | | | | | | | | | | | | | | | | | | | | | | | | | | | | | | | | | | | | | |
|----------------|--------------------------|--------------------------|--------------------------|--------------------------|-----------|--------------------------|--|-----------|--------------------------|-----------|--------------------------|-------------|--------------------------|------------|--------------------------|--------------|--------------------------|---------|--------------------------|--------------|--------------------------|---------|--------------------------|--------------|--------------------------|--------|--------------------------|-------------|--------------------------|---------|--------------------------|-----------|--------------------------|-------|--------------------------|---------------|--------------------------|------|--------------------------|
| | AMP MODEL: | | Clean | <input type="checkbox"/> | Top Mount | <input type="checkbox"/> | EFFECT: <table border="1"> <tr><td>Comp/Echo</td><td><input type="checkbox"/></td><td>Touch Wah</td><td><input type="checkbox"/></td></tr> <tr><td>Comp/Chorus</td><td><input type="checkbox"/></td><td>Compressor</td><td><input type="checkbox"/></td></tr> <tr><td>Cmp/Flg/Echo</td><td><input type="checkbox"/></td><td>Tremolo</td><td><input type="checkbox"/></td></tr> <tr><td>Cmp/Cho/Echo</td><td><input type="checkbox"/></td><td>Vibrato</td><td><input type="checkbox"/></td></tr> <tr><td>Cmp/Vib/Echo</td><td><input type="checkbox"/></td><td>Chorus</td><td><input type="checkbox"/></td></tr> <tr><td>Flange/Echo</td><td><input type="checkbox"/></td><td>Flanger</td><td><input type="checkbox"/></td></tr> <tr><td>Chor/Echo</td><td><input type="checkbox"/></td><td>Delay</td><td><input type="checkbox"/></td></tr> <tr><td>Rotating Spkr</td><td><input type="checkbox"/></td><td>Echo</td><td><input type="checkbox"/></td></tr> </table> | Comp/Echo | <input type="checkbox"/> | Touch Wah | <input type="checkbox"/> | Comp/Chorus | <input type="checkbox"/> | Compressor | <input type="checkbox"/> | Cmp/Flg/Echo | <input type="checkbox"/> | Tremolo | <input type="checkbox"/> | Cmp/Cho/Echo | <input type="checkbox"/> | Vibrato | <input type="checkbox"/> | Cmp/Vib/Echo | <input type="checkbox"/> | Chorus | <input type="checkbox"/> | Flange/Echo | <input type="checkbox"/> | Flanger | <input type="checkbox"/> | Chor/Echo | <input type="checkbox"/> | Delay | <input type="checkbox"/> | Rotating Spkr | <input type="checkbox"/> | Echo | <input type="checkbox"/> |
| | Comp/Echo | <input type="checkbox"/> | Touch Wah | <input type="checkbox"/> | | | | | | | | | | | | | | | | | | | | | | | | | | | | | | | | | | | |
| | Comp/Chorus | <input type="checkbox"/> | Compressor | <input type="checkbox"/> | | | | | | | | | | | | | | | | | | | | | | | | | | | | | | | | | | | |
| | Cmp/Flg/Echo | <input type="checkbox"/> | Tremolo | <input type="checkbox"/> | | | | | | | | | | | | | | | | | | | | | | | | | | | | | | | | | | | |
| | Cmp/Cho/Echo | <input type="checkbox"/> | Vibrato | <input type="checkbox"/> | | | | | | | | | | | | | | | | | | | | | | | | | | | | | | | | | | | |
| | Cmp/Vib/Echo | <input type="checkbox"/> | Chorus | <input type="checkbox"/> | | | | | | | | | | | | | | | | | | | | | | | | | | | | | | | | | | | |
| | Flange/Echo | <input type="checkbox"/> | Flanger | <input type="checkbox"/> | | | | | | | | | | | | | | | | | | | | | | | | | | | | | | | | | | | |
| | Chor/Echo | <input type="checkbox"/> | Delay | <input type="checkbox"/> | | | | | | | | | | | | | | | | | | | | | | | | | | | | | | | | | | | |
| Rotating Spkr | <input type="checkbox"/> | Echo | <input type="checkbox"/> | | | | | | | | | | | | | | | | | | | | | | | | | | | | | | | | | | | | |
| Acoustic | <input type="checkbox"/> | High Power | <input type="checkbox"/> | | | | | | | | | | | | | | | | | | | | | | | | | | | | | | | | | | | | |
| Blue Voodoo | <input type="checkbox"/> | Studio Tweed | <input type="checkbox"/> | | | | | | | | | | | | | | | | | | | | | | | | | | | | | | | | | | | | |
| Vintage Club | <input type="checkbox"/> | Black Face | <input type="checkbox"/> | | | | | | | | | | | | | | | | | | | | | | | | | | | | | | | | | | | | |
| Flexwave | <input type="checkbox"/> | Large Tweed | <input type="checkbox"/> | | | | | | | | | | | | | | | | | | | | | | | | | | | | | | | | | | | | |
| Ampeg VL | <input type="checkbox"/> | 60s Era UK | <input type="checkbox"/> | | | | | | | | | | | | | | | | | | | | | | | | | | | | | | | | | | | | |
| Calif Mod | <input type="checkbox"/> | 70s Era UK | <input type="checkbox"/> | | | | | | | | | | | | | | | | | | | | | | | | | | | | | | | | | | | | |
| Tube Rectifier | <input type="checkbox"/> | Fuzzbox | <input type="checkbox"/> | | | | | | | | | | | | | | | | | | | | | | | | | | | | | | | | | | | | |

| | | | | | | | |
|------|------|-----|--------|---------------|---------------|--------------|--------------|
| | | | | | | | |
| GAIN | BASS | MID | TREBLE | CHANNEL LEVEL | EFFECT ADJUST | REVERB LEVEL | REVERB DEPTH |

Preset # 3 We call it: *"Live at Leeds"* TAP = 114 beats/minute

| | | | | | | | | | | | | | | | | | | | | | | | | | | | | | | | | | | | | | | | |
|----------------|--------------------------|--------------------------|--------------------------|--------------------------|-----------|--------------------------|--|-----------|--------------------------|-----------|--------------------------|-------------|--------------------------|------------|--------------------------|--------------|--------------------------|---------|--------------------------|--------------|--------------------------|---------|--------------------------|--------------|--------------------------|--------|--------------------------|-------------|--------------------------|---------|--------------------------|-----------|--------------------------|-------|--------------------------|---------------|--------------------------|------|--------------------------|
| | AMP MODEL: | | Clean | <input type="checkbox"/> | Top Mount | <input type="checkbox"/> | EFFECT: <table border="1"> <tr><td>Comp/Echo</td><td><input type="checkbox"/></td><td>Touch Wah</td><td><input type="checkbox"/></td></tr> <tr><td>Comp/Chorus</td><td><input type="checkbox"/></td><td>Compressor</td><td><input type="checkbox"/></td></tr> <tr><td>Cmp/Flg/Echo</td><td><input type="checkbox"/></td><td>Tremolo</td><td><input type="checkbox"/></td></tr> <tr><td>Cmp/Cho/Echo</td><td><input type="checkbox"/></td><td>Vibrato</td><td><input type="checkbox"/></td></tr> <tr><td>Cmp/Vib/Echo</td><td><input type="checkbox"/></td><td>Chorus</td><td><input type="checkbox"/></td></tr> <tr><td>Flange/Echo</td><td><input type="checkbox"/></td><td>Flanger</td><td><input type="checkbox"/></td></tr> <tr><td>Chor/Echo</td><td><input type="checkbox"/></td><td>Delay</td><td><input type="checkbox"/></td></tr> <tr><td>Rotating Spkr</td><td><input type="checkbox"/></td><td>Echo</td><td><input type="checkbox"/></td></tr> </table> | Comp/Echo | <input type="checkbox"/> | Touch Wah | <input type="checkbox"/> | Comp/Chorus | <input type="checkbox"/> | Compressor | <input type="checkbox"/> | Cmp/Flg/Echo | <input type="checkbox"/> | Tremolo | <input type="checkbox"/> | Cmp/Cho/Echo | <input type="checkbox"/> | Vibrato | <input type="checkbox"/> | Cmp/Vib/Echo | <input type="checkbox"/> | Chorus | <input type="checkbox"/> | Flange/Echo | <input type="checkbox"/> | Flanger | <input type="checkbox"/> | Chor/Echo | <input type="checkbox"/> | Delay | <input type="checkbox"/> | Rotating Spkr | <input type="checkbox"/> | Echo | <input type="checkbox"/> |
| | Comp/Echo | <input type="checkbox"/> | Touch Wah | <input type="checkbox"/> | | | | | | | | | | | | | | | | | | | | | | | | | | | | | | | | | | | |
| | Comp/Chorus | <input type="checkbox"/> | Compressor | <input type="checkbox"/> | | | | | | | | | | | | | | | | | | | | | | | | | | | | | | | | | | | |
| | Cmp/Flg/Echo | <input type="checkbox"/> | Tremolo | <input type="checkbox"/> | | | | | | | | | | | | | | | | | | | | | | | | | | | | | | | | | | | |
| | Cmp/Cho/Echo | <input type="checkbox"/> | Vibrato | <input type="checkbox"/> | | | | | | | | | | | | | | | | | | | | | | | | | | | | | | | | | | | |
| | Cmp/Vib/Echo | <input type="checkbox"/> | Chorus | <input type="checkbox"/> | | | | | | | | | | | | | | | | | | | | | | | | | | | | | | | | | | | |
| | Flange/Echo | <input type="checkbox"/> | Flanger | <input type="checkbox"/> | | | | | | | | | | | | | | | | | | | | | | | | | | | | | | | | | | | |
| | Chor/Echo | <input type="checkbox"/> | Delay | <input type="checkbox"/> | | | | | | | | | | | | | | | | | | | | | | | | | | | | | | | | | | | |
| Rotating Spkr | <input type="checkbox"/> | Echo | <input type="checkbox"/> | | | | | | | | | | | | | | | | | | | | | | | | | | | | | | | | | | | | |
| Acoustic | <input type="checkbox"/> | High Power | <input type="checkbox"/> | | | | | | | | | | | | | | | | | | | | | | | | | | | | | | | | | | | | |
| Blue Voodoo | <input type="checkbox"/> | Studio Tweed | <input type="checkbox"/> | | | | | | | | | | | | | | | | | | | | | | | | | | | | | | | | | | | | |
| Vintage Club | <input type="checkbox"/> | Black Face | <input type="checkbox"/> | | | | | | | | | | | | | | | | | | | | | | | | | | | | | | | | | | | | |
| Flexwave | <input type="checkbox"/> | Large Tweed | <input type="checkbox"/> | | | | | | | | | | | | | | | | | | | | | | | | | | | | | | | | | | | | |
| Ampeg VL | <input type="checkbox"/> | 60s Era UK | <input type="checkbox"/> | | | | | | | | | | | | | | | | | | | | | | | | | | | | | | | | | | | | |
| Calif Mod | <input type="checkbox"/> | 70s Era UK | <input type="checkbox"/> | | | | | | | | | | | | | | | | | | | | | | | | | | | | | | | | | | | | |
| Tube Rectifier | <input type="checkbox"/> | Fuzzbox | <input type="checkbox"/> | | | | | | | | | | | | | | | | | | | | | | | | | | | | | | | | | | | | |

| | | | | | | | |
|------|------|-----|--------|---------------|---------------|--------------|--------------|
| | | | | | | | |
| GAIN | BASS | MID | TREBLE | CHANNEL LEVEL | EFFECT ADJUST | REVERB LEVEL | REVERB DEPTH |

Preset # 4 We call it: *"Voodoo Child"* TAP = N/A beats/minute

| | | | | | | | | | | | | | | | | | | | | | | | | | | | | | | | | | | | | | | | |
|----------------|--------------------------|--------------------------|--------------------------|--------------------------|-----------|--------------------------|--|-----------|--------------------------|-----------|--------------------------|-------------|--------------------------|------------|--------------------------|--------------|--------------------------|---------|--------------------------|--------------|--------------------------|---------|--------------------------|--------------|--------------------------|--------|--------------------------|-------------|--------------------------|---------|--------------------------|-----------|--------------------------|-------|--------------------------|---------------|--------------------------|------|--------------------------|
| | AMP MODEL: | | Clean | <input type="checkbox"/> | Top Mount | <input type="checkbox"/> | EFFECT: <table border="1"> <tr><td>Comp/Echo</td><td><input type="checkbox"/></td><td>Touch Wah</td><td><input type="checkbox"/></td></tr> <tr><td>Comp/Chorus</td><td><input type="checkbox"/></td><td>Compressor</td><td><input type="checkbox"/></td></tr> <tr><td>Cmp/Flg/Echo</td><td><input type="checkbox"/></td><td>Tremolo</td><td><input type="checkbox"/></td></tr> <tr><td>Cmp/Cho/Echo</td><td><input type="checkbox"/></td><td>Vibrato</td><td><input type="checkbox"/></td></tr> <tr><td>Cmp/Vib/Echo</td><td><input type="checkbox"/></td><td>Chorus</td><td><input type="checkbox"/></td></tr> <tr><td>Flange/Echo</td><td><input type="checkbox"/></td><td>Flanger</td><td><input type="checkbox"/></td></tr> <tr><td>Chor/Echo</td><td><input type="checkbox"/></td><td>Delay</td><td><input type="checkbox"/></td></tr> <tr><td>Rotating Spkr</td><td><input type="checkbox"/></td><td>Echo</td><td><input type="checkbox"/></td></tr> </table> | Comp/Echo | <input type="checkbox"/> | Touch Wah | <input type="checkbox"/> | Comp/Chorus | <input type="checkbox"/> | Compressor | <input type="checkbox"/> | Cmp/Flg/Echo | <input type="checkbox"/> | Tremolo | <input type="checkbox"/> | Cmp/Cho/Echo | <input type="checkbox"/> | Vibrato | <input type="checkbox"/> | Cmp/Vib/Echo | <input type="checkbox"/> | Chorus | <input type="checkbox"/> | Flange/Echo | <input type="checkbox"/> | Flanger | <input type="checkbox"/> | Chor/Echo | <input type="checkbox"/> | Delay | <input type="checkbox"/> | Rotating Spkr | <input type="checkbox"/> | Echo | <input type="checkbox"/> |
| | Comp/Echo | <input type="checkbox"/> | Touch Wah | <input type="checkbox"/> | | | | | | | | | | | | | | | | | | | | | | | | | | | | | | | | | | | |
| | Comp/Chorus | <input type="checkbox"/> | Compressor | <input type="checkbox"/> | | | | | | | | | | | | | | | | | | | | | | | | | | | | | | | | | | | |
| | Cmp/Flg/Echo | <input type="checkbox"/> | Tremolo | <input type="checkbox"/> | | | | | | | | | | | | | | | | | | | | | | | | | | | | | | | | | | | |
| | Cmp/Cho/Echo | <input type="checkbox"/> | Vibrato | <input type="checkbox"/> | | | | | | | | | | | | | | | | | | | | | | | | | | | | | | | | | | | |
| | Cmp/Vib/Echo | <input type="checkbox"/> | Chorus | <input type="checkbox"/> | | | | | | | | | | | | | | | | | | | | | | | | | | | | | | | | | | | |
| | Flange/Echo | <input type="checkbox"/> | Flanger | <input type="checkbox"/> | | | | | | | | | | | | | | | | | | | | | | | | | | | | | | | | | | | |
| | Chor/Echo | <input type="checkbox"/> | Delay | <input type="checkbox"/> | | | | | | | | | | | | | | | | | | | | | | | | | | | | | | | | | | | |
| Rotating Spkr | <input type="checkbox"/> | Echo | <input type="checkbox"/> | | | | | | | | | | | | | | | | | | | | | | | | | | | | | | | | | | | | |
| Acoustic | <input type="checkbox"/> | High Power | <input type="checkbox"/> | | | | | | | | | | | | | | | | | | | | | | | | | | | | | | | | | | | | |
| Blue Voodoo | <input type="checkbox"/> | Studio Tweed | <input type="checkbox"/> | | | | | | | | | | | | | | | | | | | | | | | | | | | | | | | | | | | | |
| Vintage Club | <input type="checkbox"/> | Black Face | <input type="checkbox"/> | | | | | | | | | | | | | | | | | | | | | | | | | | | | | | | | | | | | |
| Flexwave | <input type="checkbox"/> | Large Tweed | <input type="checkbox"/> | | | | | | | | | | | | | | | | | | | | | | | | | | | | | | | | | | | | |
| Ampeg VL | <input type="checkbox"/> | 60s Era UK | <input type="checkbox"/> | | | | | | | | | | | | | | | | | | | | | | | | | | | | | | | | | | | | |
| Calif Mod | <input type="checkbox"/> | 70s Era UK | <input type="checkbox"/> | | | | | | | | | | | | | | | | | | | | | | | | | | | | | | | | | | | | |
| Tube Rectifier | <input type="checkbox"/> | Fuzzbox | <input type="checkbox"/> | | | | | | | | | | | | | | | | | | | | | | | | | | | | | | | | | | | | |

| | | | | | | | |
|------|------|-----|--------|---------------|---------------|--------------|--------------|
| | | | | | | | |
| GAIN | BASS | MID | TREBLE | CHANNEL LEVEL | EFFECT ADJUST | REVERB LEVEL | REVERB DEPTH |

Preset # 5 We call it: *"Arena Rock"* TAP = 62 beats/minute

| | | | | | | | | | | | | | | | | | | | | | | | | | | | | | | | | | | | | | | | |
|----------------|--------------------------|--------------------------|--------------------------|--------------------------|-----------|--------------------------|--|-----------|--------------------------|-----------|--------------------------|-------------|--------------------------|------------|--------------------------|--------------|--------------------------|---------|--------------------------|--------------|--------------------------|---------|--------------------------|--------------|--------------------------|--------|--------------------------|-------------|--------------------------|---------|--------------------------|-----------|--------------------------|-------|--------------------------|---------------|--------------------------|------|--------------------------|
| | AMP MODEL: | | Clean | <input type="checkbox"/> | Top Mount | <input type="checkbox"/> | EFFECT: <table border="1"> <tr><td>Comp/Echo</td><td><input type="checkbox"/></td><td>Touch Wah</td><td><input type="checkbox"/></td></tr> <tr><td>Comp/Chorus</td><td><input type="checkbox"/></td><td>Compressor</td><td><input type="checkbox"/></td></tr> <tr><td>Cmp/Flg/Echo</td><td><input type="checkbox"/></td><td>Tremolo</td><td><input type="checkbox"/></td></tr> <tr><td>Cmp/Cho/Echo</td><td><input type="checkbox"/></td><td>Vibrato</td><td><input type="checkbox"/></td></tr> <tr><td>Cmp/Vib/Echo</td><td><input type="checkbox"/></td><td>Chorus</td><td><input type="checkbox"/></td></tr> <tr><td>Flange/Echo</td><td><input type="checkbox"/></td><td>Flanger</td><td><input type="checkbox"/></td></tr> <tr><td>Chor/Echo</td><td><input type="checkbox"/></td><td>Delay</td><td><input type="checkbox"/></td></tr> <tr><td>Rotating Spkr</td><td><input type="checkbox"/></td><td>Echo</td><td><input type="checkbox"/></td></tr> </table> | Comp/Echo | <input type="checkbox"/> | Touch Wah | <input type="checkbox"/> | Comp/Chorus | <input type="checkbox"/> | Compressor | <input type="checkbox"/> | Cmp/Flg/Echo | <input type="checkbox"/> | Tremolo | <input type="checkbox"/> | Cmp/Cho/Echo | <input type="checkbox"/> | Vibrato | <input type="checkbox"/> | Cmp/Vib/Echo | <input type="checkbox"/> | Chorus | <input type="checkbox"/> | Flange/Echo | <input type="checkbox"/> | Flanger | <input type="checkbox"/> | Chor/Echo | <input type="checkbox"/> | Delay | <input type="checkbox"/> | Rotating Spkr | <input type="checkbox"/> | Echo | <input type="checkbox"/> |
| | Comp/Echo | <input type="checkbox"/> | Touch Wah | <input type="checkbox"/> | | | | | | | | | | | | | | | | | | | | | | | | | | | | | | | | | | | |
| | Comp/Chorus | <input type="checkbox"/> | Compressor | <input type="checkbox"/> | | | | | | | | | | | | | | | | | | | | | | | | | | | | | | | | | | | |
| | Cmp/Flg/Echo | <input type="checkbox"/> | Tremolo | <input type="checkbox"/> | | | | | | | | | | | | | | | | | | | | | | | | | | | | | | | | | | | |
| | Cmp/Cho/Echo | <input type="checkbox"/> | Vibrato | <input type="checkbox"/> | | | | | | | | | | | | | | | | | | | | | | | | | | | | | | | | | | | |
| | Cmp/Vib/Echo | <input type="checkbox"/> | Chorus | <input type="checkbox"/> | | | | | | | | | | | | | | | | | | | | | | | | | | | | | | | | | | | |
| | Flange/Echo | <input type="checkbox"/> | Flanger | <input type="checkbox"/> | | | | | | | | | | | | | | | | | | | | | | | | | | | | | | | | | | | |
| | Chor/Echo | <input type="checkbox"/> | Delay | <input type="checkbox"/> | | | | | | | | | | | | | | | | | | | | | | | | | | | | | | | | | | | |
| Rotating Spkr | <input type="checkbox"/> | Echo | <input type="checkbox"/> | | | | | | | | | | | | | | | | | | | | | | | | | | | | | | | | | | | | |
| Acoustic | <input type="checkbox"/> | High Power | <input type="checkbox"/> | | | | | | | | | | | | | | | | | | | | | | | | | | | | | | | | | | | | |
| Blue Voodoo | <input type="checkbox"/> | Studio Tweed | <input type="checkbox"/> | | | | | | | | | | | | | | | | | | | | | | | | | | | | | | | | | | | | |
| Vintage Club | <input type="checkbox"/> | Black Face | <input type="checkbox"/> | | | | | | | | | | | | | | | | | | | | | | | | | | | | | | | | | | | | |
| Flexwave | <input type="checkbox"/> | Large Tweed | <input type="checkbox"/> | | | | | | | | | | | | | | | | | | | | | | | | | | | | | | | | | | | | |
| Ampeg VL | <input type="checkbox"/> | 60s Era UK | <input type="checkbox"/> | | | | | | | | | | | | | | | | | | | | | | | | | | | | | | | | | | | | |
| Calif Mod | <input type="checkbox"/> | 70s Era UK | <input type="checkbox"/> | | | | | | | | | | | | | | | | | | | | | | | | | | | | | | | | | | | | |
| Tube Rectifier | <input type="checkbox"/> | Fuzzbox | <input type="checkbox"/> | | | | | | | | | | | | | | | | | | | | | | | | | | | | | | | | | | | | |

| | | | | | | | |
|------|------|-----|--------|---------------|---------------|--------------|--------------|
| | | | | | | | |
| GAIN | BASS | MID | TREBLE | CHANNEL LEVEL | EFFECT ADJUST | REVERB LEVEL | REVERB DEPTH |

FAVORITES

DX-112/212 Digital Guitar Amplifier **CRATE**

FACTORY PRESETS 6–10 - BANK B (A/B BUTTON LIT)

Preset # 6 We call it: *"Jazzy Chorus"* TAP = 61 beats/minute

AMP MODEL:

| | | | |
|----------------|--------------------------|--------------|--------------------------|
| Clean | <input type="checkbox"/> | Top Mount | <input type="checkbox"/> |
| Acoustic | <input type="checkbox"/> | High Power | <input type="checkbox"/> |
| Blue Voodoo | <input type="checkbox"/> | Studio Tweed | <input type="checkbox"/> |
| Vintage Club | <input type="checkbox"/> | Black Face | <input type="checkbox"/> |
| Flexwave | <input type="checkbox"/> | Large Tweed | <input type="checkbox"/> |
| Ampeg VL | <input type="checkbox"/> | 60s Era UK | <input type="checkbox"/> |
| Calif Mod | <input type="checkbox"/> | 70s Era UK | <input type="checkbox"/> |
| Tube Rectifier | <input type="checkbox"/> | Fuzzbox | <input type="checkbox"/> |

EFFECT:

| | | | |
|---------------|--------------------------|------------|--------------------------|
| Comp/Echo | <input type="checkbox"/> | Touch Wah | <input type="checkbox"/> |
| Comp/Chorus | <input type="checkbox"/> | Compressor | <input type="checkbox"/> |
| Comp/Flg/Echo | <input type="checkbox"/> | Tremolo | <input type="checkbox"/> |
| Comp/Cho/Echo | <input type="checkbox"/> | Vibrato | <input type="checkbox"/> |
| Comp/Vib/Echo | <input type="checkbox"/> | Chorus | <input type="checkbox"/> |
| Flange/Echo | <input type="checkbox"/> | Flanger | <input type="checkbox"/> |
| Chor/Echo | <input type="checkbox"/> | Delay | <input type="checkbox"/> |
| Rotating Spkr | <input type="checkbox"/> | Echo | <input type="checkbox"/> |

Controls: GAIN, BASS, MID, TREBLE, CHANNEL LEVEL, EFFECT ADJUST, REVERB LEVEL, REVERB DEPTH

Preset # 7 We call it: *"British Invasion"* TAP = 162 beats/minute

AMP MODEL:

| | | | |
|----------------|--------------------------|--------------|-------------------------------------|
| Clean | <input type="checkbox"/> | Top Mount | <input checked="" type="checkbox"/> |
| Acoustic | <input type="checkbox"/> | High Power | <input type="checkbox"/> |
| Blue Voodoo | <input type="checkbox"/> | Studio Tweed | <input type="checkbox"/> |
| Vintage Club | <input type="checkbox"/> | Black Face | <input type="checkbox"/> |
| Flexwave | <input type="checkbox"/> | Large Tweed | <input type="checkbox"/> |
| Ampeg VL | <input type="checkbox"/> | 60s Era UK | <input type="checkbox"/> |
| Calif Mod | <input type="checkbox"/> | 70s Era UK | <input type="checkbox"/> |
| Tube Rectifier | <input type="checkbox"/> | Fuzzbox | <input type="checkbox"/> |

EFFECT:

| | | | |
|---------------|-------------------------------------|------------|--------------------------|
| Comp/Echo | <input type="checkbox"/> | Touch Wah | <input type="checkbox"/> |
| Comp/Chorus | <input type="checkbox"/> | Compressor | <input type="checkbox"/> |
| Comp/Flg/Echo | <input type="checkbox"/> | Tremolo | <input type="checkbox"/> |
| Comp/Cho/Echo | <input checked="" type="checkbox"/> | Vibrato | <input type="checkbox"/> |
| Comp/Vib/Echo | <input type="checkbox"/> | Chorus | <input type="checkbox"/> |
| Flange/Echo | <input type="checkbox"/> | Flanger | <input type="checkbox"/> |
| Chor/Echo | <input type="checkbox"/> | Delay | <input type="checkbox"/> |
| Rotating Spkr | <input type="checkbox"/> | Echo | <input type="checkbox"/> |

Controls: GAIN, BASS, MID, TREBLE, CHANNEL LEVEL, EFFECT ADJUST, REVERB LEVEL, REVERB DEPTH

Preset # 8 We call it: *"Smoky Bar Blues"* TAP = 275 beats/minute

AMP MODEL:

| | | | |
|----------------|-------------------------------------|--------------|--------------------------|
| Clean | <input type="checkbox"/> | Top Mount | <input type="checkbox"/> |
| Acoustic | <input type="checkbox"/> | High Power | <input type="checkbox"/> |
| Blue Voodoo | <input type="checkbox"/> | Studio Tweed | <input type="checkbox"/> |
| Vintage Club | <input checked="" type="checkbox"/> | Black Face | <input type="checkbox"/> |
| Flexwave | <input type="checkbox"/> | Large Tweed | <input type="checkbox"/> |
| Ampeg VL | <input type="checkbox"/> | 60s Era UK | <input type="checkbox"/> |
| Calif Mod | <input type="checkbox"/> | 70s Era UK | <input type="checkbox"/> |
| Tube Rectifier | <input type="checkbox"/> | Fuzzbox | <input type="checkbox"/> |

EFFECT:

| | | | |
|---------------|--------------------------|------------|-------------------------------------|
| Comp/Echo | <input type="checkbox"/> | Touch Wah | <input type="checkbox"/> |
| Comp/Chorus | <input type="checkbox"/> | Compressor | <input type="checkbox"/> |
| Comp/Flg/Echo | <input type="checkbox"/> | Tremolo | <input type="checkbox"/> |
| Comp/Cho/Echo | <input type="checkbox"/> | Vibrato | <input type="checkbox"/> |
| Comp/Vib/Echo | <input type="checkbox"/> | Chorus | <input type="checkbox"/> |
| Flange/Echo | <input type="checkbox"/> | Flanger | <input type="checkbox"/> |
| Chor/Echo | <input type="checkbox"/> | Delay | <input type="checkbox"/> |
| Rotating Spkr | <input type="checkbox"/> | Echo | <input checked="" type="checkbox"/> |

Controls: GAIN, BASS, MID, TREBLE, CHANNEL LEVEL, EFFECT ADJUST, REVERB LEVEL, REVERB DEPTH

Preset # 9 We call it: *"Space Rock"* TAP = 44 beats/minute

AMP MODEL:

| | | | |
|----------------|-------------------------------------|--------------|--------------------------|
| Clean | <input type="checkbox"/> | Top Mount | <input type="checkbox"/> |
| Acoustic | <input type="checkbox"/> | High Power | <input type="checkbox"/> |
| Blue Voodoo | <input type="checkbox"/> | Studio Tweed | <input type="checkbox"/> |
| Vintage Club | <input type="checkbox"/> | Black Face | <input type="checkbox"/> |
| Flexwave | <input type="checkbox"/> | Large Tweed | <input type="checkbox"/> |
| Ampeg VL | <input type="checkbox"/> | 60s Era UK | <input type="checkbox"/> |
| Calif Mod | <input type="checkbox"/> | 70s Era UK | <input type="checkbox"/> |
| Tube Rectifier | <input checked="" type="checkbox"/> | Fuzzbox | <input type="checkbox"/> |

EFFECT:

| | | | |
|---------------|-------------------------------------|------------|--------------------------|
| Comp/Echo | <input type="checkbox"/> | Touch Wah | <input type="checkbox"/> |
| Comp/Chorus | <input type="checkbox"/> | Compressor | <input type="checkbox"/> |
| Comp/Flg/Echo | <input type="checkbox"/> | Tremolo | <input type="checkbox"/> |
| Comp/Cho/Echo | <input type="checkbox"/> | Vibrato | <input type="checkbox"/> |
| Comp/Vib/Echo | <input type="checkbox"/> | Chorus | <input type="checkbox"/> |
| Flange/Echo | <input checked="" type="checkbox"/> | Flanger | <input type="checkbox"/> |
| Chor/Echo | <input type="checkbox"/> | Delay | <input type="checkbox"/> |
| Rotating Spkr | <input type="checkbox"/> | Echo | <input type="checkbox"/> |

Controls: GAIN, BASS, MID, TREBLE, CHANNEL LEVEL, EFFECT ADJUST, REVERB LEVEL, REVERB DEPTH

Preset # 10 We call it: *"Full Metal Jacket" (Crank it!!)* TAP = N/A beats/minute

AMP MODEL:

| | | | |
|----------------|-------------------------------------|--------------|--------------------------|
| Clean | <input type="checkbox"/> | Top Mount | <input type="checkbox"/> |
| Acoustic | <input type="checkbox"/> | High Power | <input type="checkbox"/> |
| Blue Voodoo | <input type="checkbox"/> | Studio Tweed | <input type="checkbox"/> |
| Vintage Club | <input type="checkbox"/> | Black Face | <input type="checkbox"/> |
| Flexwave | <input checked="" type="checkbox"/> | Large Tweed | <input type="checkbox"/> |
| Ampeg VL | <input type="checkbox"/> | 60s Era UK | <input type="checkbox"/> |
| Calif Mod | <input type="checkbox"/> | 70s Era UK | <input type="checkbox"/> |
| Tube Rectifier | <input type="checkbox"/> | Fuzzbox | <input type="checkbox"/> |

EFFECT:

| | | | |
|---------------|--------------------------|------------|-------------------------------------|
| Comp/Echo | <input type="checkbox"/> | Touch Wah | <input type="checkbox"/> |
| Comp/Chorus | <input type="checkbox"/> | Compressor | <input checked="" type="checkbox"/> |
| Comp/Flg/Echo | <input type="checkbox"/> | Tremolo | <input type="checkbox"/> |
| Comp/Cho/Echo | <input type="checkbox"/> | Vibrato | <input type="checkbox"/> |
| Comp/Vib/Echo | <input type="checkbox"/> | Chorus | <input type="checkbox"/> |
| Flange/Echo | <input type="checkbox"/> | Flanger | <input type="checkbox"/> |
| Chor/Echo | <input type="checkbox"/> | Delay | <input type="checkbox"/> |
| Rotating Spkr | <input type="checkbox"/> | Echo | <input type="checkbox"/> |

Controls: GAIN, BASS, MID, TREBLE, CHANNEL LEVEL, EFFECT ADJUST, REVERB LEVEL, REVERB DEPTH

FAVORITES

CRATE DX-112/212 Digital Guitar Amplifier

USER PRESETS 1– 5 - BANK A

Playing Favorites: Use the blank charts in this section to record the knob settings of your favorite presets. (We suggest using a pencil so you can go back and make changes later. You could also photocopy one of the pages while it's still blank.)

Preset # 1 *I think I'll call it:* _____ Set TAP for _____ beats/minute

| | | | | | |
|----------------------------------|---|---------------------------------------|-------------------------------|--|-------------------------------------|
| AMP MODEL: (CHECK ONE) | <input type="checkbox"/> Clean | <input type="checkbox"/> Top Mount | EFFECT: (CHECK ONE) | <input type="checkbox"/> Comp/Echo | <input type="checkbox"/> Touch Wah |
| | <input type="checkbox"/> Acoustic | <input type="checkbox"/> High Power | | <input type="checkbox"/> Comp/Chorus | <input type="checkbox"/> Compressor |
| | <input type="checkbox"/> Blue Voodoo | <input type="checkbox"/> Studio Tweed | | <input type="checkbox"/> Cmp/Flg/Echo | <input type="checkbox"/> Tremolo |
| | <input type="checkbox"/> Vintage Club | <input type="checkbox"/> Black Face | | <input type="checkbox"/> Cmp/Cho/Echo | <input type="checkbox"/> Vibrato |
| | <input type="checkbox"/> Flexwave | <input type="checkbox"/> Large Tweed | | <input type="checkbox"/> Cmp/Vib/Echo | <input type="checkbox"/> Chorus |
| | <input type="checkbox"/> Ampeg VL | <input type="checkbox"/> 60s Era UK | | <input type="checkbox"/> Flange/Echo | <input type="checkbox"/> Flanger |
| | <input type="checkbox"/> Calif Mod | <input type="checkbox"/> 70s Era UK | | <input type="checkbox"/> Chor/Echo | <input type="checkbox"/> Delay |
| | <input type="checkbox"/> Tube Rectifier | <input type="checkbox"/> Fuzzbox | | <input type="checkbox"/> Rotating Spkr | <input type="checkbox"/> Echo |

| | | | | | | | |
|------|------|-----|--------|---------------|---------------|--------------|--------------|
| | | | | | | | |
| GAIN | BASS | MID | TREBLE | CHANNEL LEVEL | EFFECT ADJUST | REVERB LEVEL | REVERB DEPTH |

Preset # 2 *I think I'll call it:* _____ Set TAP for _____ beats/minute

| | | | | | |
|----------------------------------|---|---------------------------------------|-------------------------------|--|-------------------------------------|
| AMP MODEL: (CHECK ONE) | <input type="checkbox"/> Clean | <input type="checkbox"/> Top Mount | EFFECT: (CHECK ONE) | <input type="checkbox"/> Comp/Echo | <input type="checkbox"/> Touch Wah |
| | <input type="checkbox"/> Acoustic | <input type="checkbox"/> High Power | | <input type="checkbox"/> Comp/Chorus | <input type="checkbox"/> Compressor |
| | <input type="checkbox"/> Blue Voodoo | <input type="checkbox"/> Studio Tweed | | <input type="checkbox"/> Cmp/Flg/Echo | <input type="checkbox"/> Tremolo |
| | <input type="checkbox"/> Vintage Club | <input type="checkbox"/> Black Face | | <input type="checkbox"/> Cmp/Cho/Echo | <input type="checkbox"/> Vibrato |
| | <input type="checkbox"/> Flexwave | <input type="checkbox"/> Large Tweed | | <input type="checkbox"/> Cmp/Vib/Echo | <input type="checkbox"/> Chorus |
| | <input type="checkbox"/> Ampeg VL | <input type="checkbox"/> 60s Era UK | | <input type="checkbox"/> Flange/Echo | <input type="checkbox"/> Flanger |
| | <input type="checkbox"/> Calif Mod | <input type="checkbox"/> 70s Era UK | | <input type="checkbox"/> Chor/Echo | <input type="checkbox"/> Delay |
| | <input type="checkbox"/> Tube Rectifier | <input type="checkbox"/> Fuzzbox | | <input type="checkbox"/> Rotating Spkr | <input type="checkbox"/> Echo |

| | | | | | | | |
|------|------|-----|--------|---------------|---------------|--------------|--------------|
| | | | | | | | |
| GAIN | BASS | MID | TREBLE | CHANNEL LEVEL | EFFECT ADJUST | REVERB LEVEL | REVERB DEPTH |

Preset # 3 *I think I'll call it:* _____ Set TAP for _____ beats/minute

| | | | | | |
|----------------------------------|---|---------------------------------------|-------------------------------|--|-------------------------------------|
| AMP MODEL: (CHECK ONE) | <input type="checkbox"/> Clean | <input type="checkbox"/> Top Mount | EFFECT: (CHECK ONE) | <input type="checkbox"/> Comp/Echo | <input type="checkbox"/> Touch Wah |
| | <input type="checkbox"/> Acoustic | <input type="checkbox"/> High Power | | <input type="checkbox"/> Comp/Chorus | <input type="checkbox"/> Compressor |
| | <input type="checkbox"/> Blue Voodoo | <input type="checkbox"/> Studio Tweed | | <input type="checkbox"/> Cmp/Flg/Echo | <input type="checkbox"/> Tremolo |
| | <input type="checkbox"/> Vintage Club | <input type="checkbox"/> Black Face | | <input type="checkbox"/> Cmp/Cho/Echo | <input type="checkbox"/> Vibrato |
| | <input type="checkbox"/> Flexwave | <input type="checkbox"/> Large Tweed | | <input type="checkbox"/> Cmp/Vib/Echo | <input type="checkbox"/> Chorus |
| | <input type="checkbox"/> Ampeg VL | <input type="checkbox"/> 60s Era UK | | <input type="checkbox"/> Flange/Echo | <input type="checkbox"/> Flanger |
| | <input type="checkbox"/> Calif Mod | <input type="checkbox"/> 70s Era UK | | <input type="checkbox"/> Chor/Echo | <input type="checkbox"/> Delay |
| | <input type="checkbox"/> Tube Rectifier | <input type="checkbox"/> Fuzzbox | | <input type="checkbox"/> Rotating Spkr | <input type="checkbox"/> Echo |

| | | | | | | | |
|------|------|-----|--------|---------------|---------------|--------------|--------------|
| | | | | | | | |
| GAIN | BASS | MID | TREBLE | CHANNEL LEVEL | EFFECT ADJUST | REVERB LEVEL | REVERB DEPTH |

Preset # 4 *I think I'll call it:* _____ Set TAP for _____ beats/minute

| | | | | | |
|----------------------------------|---|---------------------------------------|-------------------------------|--|-------------------------------------|
| AMP MODEL: (CHECK ONE) | <input type="checkbox"/> Clean | <input type="checkbox"/> Top Mount | EFFECT: (CHECK ONE) | <input type="checkbox"/> Comp/Echo | <input type="checkbox"/> Touch Wah |
| | <input type="checkbox"/> Acoustic | <input type="checkbox"/> High Power | | <input type="checkbox"/> Comp/Chorus | <input type="checkbox"/> Compressor |
| | <input type="checkbox"/> Blue Voodoo | <input type="checkbox"/> Studio Tweed | | <input type="checkbox"/> Cmp/Flg/Echo | <input type="checkbox"/> Tremolo |
| | <input type="checkbox"/> Vintage Club | <input type="checkbox"/> Black Face | | <input type="checkbox"/> Cmp/Cho/Echo | <input type="checkbox"/> Vibrato |
| | <input type="checkbox"/> Flexwave | <input type="checkbox"/> Large Tweed | | <input type="checkbox"/> Cmp/Vib/Echo | <input type="checkbox"/> Chorus |
| | <input type="checkbox"/> Ampeg VL | <input type="checkbox"/> 60s Era UK | | <input type="checkbox"/> Flange/Echo | <input type="checkbox"/> Flanger |
| | <input type="checkbox"/> Calif Mod | <input type="checkbox"/> 70s Era UK | | <input type="checkbox"/> Chor/Echo | <input type="checkbox"/> Delay |
| | <input type="checkbox"/> Tube Rectifier | <input type="checkbox"/> Fuzzbox | | <input type="checkbox"/> Rotating Spkr | <input type="checkbox"/> Echo |

| | | | | | | | |
|------|------|-----|--------|---------------|---------------|--------------|--------------|
| | | | | | | | |
| GAIN | BASS | MID | TREBLE | CHANNEL LEVEL | EFFECT ADJUST | REVERB LEVEL | REVERB DEPTH |

Preset # 5 *I think I'll call it:* _____ Set TAP for _____ beats/minute

| | | | | | |
|----------------------------------|---|---------------------------------------|-------------------------------|--|-------------------------------------|
| AMP MODEL: (CHECK ONE) | <input type="checkbox"/> Clean | <input type="checkbox"/> Top Mount | EFFECT: (CHECK ONE) | <input type="checkbox"/> Comp/Echo | <input type="checkbox"/> Touch Wah |
| | <input type="checkbox"/> Acoustic | <input type="checkbox"/> High Power | | <input type="checkbox"/> Comp/Chorus | <input type="checkbox"/> Compressor |
| | <input type="checkbox"/> Blue Voodoo | <input type="checkbox"/> Studio Tweed | | <input type="checkbox"/> Cmp/Flg/Echo | <input type="checkbox"/> Tremolo |
| | <input type="checkbox"/> Vintage Club | <input type="checkbox"/> Black Face | | <input type="checkbox"/> Cmp/Cho/Echo | <input type="checkbox"/> Vibrato |
| | <input type="checkbox"/> Flexwave | <input type="checkbox"/> Large Tweed | | <input type="checkbox"/> Cmp/Vib/Echo | <input type="checkbox"/> Chorus |
| | <input type="checkbox"/> Ampeg VL | <input type="checkbox"/> 60s Era UK | | <input type="checkbox"/> Flange/Echo | <input type="checkbox"/> Flanger |
| | <input type="checkbox"/> Calif Mod | <input type="checkbox"/> 70s Era UK | | <input type="checkbox"/> Chor/Echo | <input type="checkbox"/> Delay |
| | <input type="checkbox"/> Tube Rectifier | <input type="checkbox"/> Fuzzbox | | <input type="checkbox"/> Rotating Spkr | <input type="checkbox"/> Echo |

| | | | | | | | |
|------|------|-----|--------|---------------|---------------|--------------|--------------|
| | | | | | | | |
| GAIN | BASS | MID | TREBLE | CHANNEL LEVEL | EFFECT ADJUST | REVERB LEVEL | REVERB DEPTH |

DX-112/212 Digital Guitar Amplifier **CRATE**

USER PRESETS 6-10 - BANK B

Preset # 6 *I think I'll call it:* _____ Set TAP for _____ beats/minute

| | | | | | |
|---|---------------------------------------|--|--------------------------------|--|-------------------------------------|
| AMP MODEL: (CHECK ONE) | <input type="checkbox"/> Clean | <input type="checkbox"/> Top Mount | EFFECT: (CHECK ONE) | <input type="checkbox"/> Comp/Echo | <input type="checkbox"/> Touch Wah |
| | <input type="checkbox"/> Acoustic | <input type="checkbox"/> High Power | | <input type="checkbox"/> Comp/Chorus | <input type="checkbox"/> Compressor |
| | <input type="checkbox"/> Blue Voodoo | <input type="checkbox"/> Studio Tweed | | <input type="checkbox"/> Comp/Flg/Echo | <input type="checkbox"/> Tremolo |
| | <input type="checkbox"/> Vintage Club | <input type="checkbox"/> Black Face | | <input type="checkbox"/> Cmp/Cho/Echo | <input type="checkbox"/> Vibrato |
| | <input type="checkbox"/> Flexwave | <input type="checkbox"/> Large Tweed | | <input type="checkbox"/> Cmp/Vib/Echo | <input type="checkbox"/> Chorus |
| | <input type="checkbox"/> Ampeg VL | <input type="checkbox"/> 60s Era UK | | <input type="checkbox"/> Flange/Echo | <input type="checkbox"/> Flanger |
| <input type="checkbox"/> Calif Mod | <input type="checkbox"/> 70s Era UK | <input type="checkbox"/> Chor/Echo | <input type="checkbox"/> Delay | | |
| <input type="checkbox"/> Tube Rectifier | <input type="checkbox"/> Fuzzbox | <input type="checkbox"/> Rotating Spkr | <input type="checkbox"/> Echo | | |

| | | | | | | | |
|------|------|-----|--------|---------------|---------------|--------------|--------------|
| | | | | | | | |
| GAIN | BASS | MID | TREBLE | CHANNEL LEVEL | EFFECT ADJUST | REVERB LEVEL | REVERB DEPTH |

Preset # 7 *I think I'll call it:* _____ Set TAP for _____ beats/minute

| | | | | | |
|---|---------------------------------------|--|--------------------------------|--|-------------------------------------|
| AMP MODEL: (CHECK ONE) | <input type="checkbox"/> Clean | <input type="checkbox"/> Top Mount | EFFECT: (CHECK ONE) | <input type="checkbox"/> Comp/Echo | <input type="checkbox"/> Touch Wah |
| | <input type="checkbox"/> Acoustic | <input type="checkbox"/> High Power | | <input type="checkbox"/> Comp/Chorus | <input type="checkbox"/> Compressor |
| | <input type="checkbox"/> Blue Voodoo | <input type="checkbox"/> Studio Tweed | | <input type="checkbox"/> Comp/Flg/Echo | <input type="checkbox"/> Tremolo |
| | <input type="checkbox"/> Vintage Club | <input type="checkbox"/> Black Face | | <input type="checkbox"/> Cmp/Cho/Echo | <input type="checkbox"/> Vibrato |
| | <input type="checkbox"/> Flexwave | <input type="checkbox"/> Large Tweed | | <input type="checkbox"/> Cmp/Vib/Echo | <input type="checkbox"/> Chorus |
| | <input type="checkbox"/> Ampeg VL | <input type="checkbox"/> 60s Era UK | | <input type="checkbox"/> Flange/Echo | <input type="checkbox"/> Flanger |
| <input type="checkbox"/> Calif Mod | <input type="checkbox"/> 70s Era UK | <input type="checkbox"/> Chor/Echo | <input type="checkbox"/> Delay | | |
| <input type="checkbox"/> Tube Rectifier | <input type="checkbox"/> Fuzzbox | <input type="checkbox"/> Rotating Spkr | <input type="checkbox"/> Echo | | |

| | | | | | | | |
|------|------|-----|--------|---------------|---------------|--------------|--------------|
| | | | | | | | |
| GAIN | BASS | MID | TREBLE | CHANNEL LEVEL | EFFECT ADJUST | REVERB LEVEL | REVERB DEPTH |

Preset # 8 *I think I'll call it:* _____ Set TAP for _____ beats/minute

| | | | | | |
|---|---------------------------------------|--|--------------------------------|--|-------------------------------------|
| AMP MODEL: (CHECK ONE) | <input type="checkbox"/> Clean | <input type="checkbox"/> Top Mount | EFFECT: (CHECK ONE) | <input type="checkbox"/> Comp/Echo | <input type="checkbox"/> Touch Wah |
| | <input type="checkbox"/> Acoustic | <input type="checkbox"/> High Power | | <input type="checkbox"/> Comp/Chorus | <input type="checkbox"/> Compressor |
| | <input type="checkbox"/> Blue Voodoo | <input type="checkbox"/> Studio Tweed | | <input type="checkbox"/> Comp/Flg/Echo | <input type="checkbox"/> Tremolo |
| | <input type="checkbox"/> Vintage Club | <input type="checkbox"/> Black Face | | <input type="checkbox"/> Cmp/Cho/Echo | <input type="checkbox"/> Vibrato |
| | <input type="checkbox"/> Flexwave | <input type="checkbox"/> Large Tweed | | <input type="checkbox"/> Cmp/Vib/Echo | <input type="checkbox"/> Chorus |
| | <input type="checkbox"/> Ampeg VL | <input type="checkbox"/> 60s Era UK | | <input type="checkbox"/> Flange/Echo | <input type="checkbox"/> Flanger |
| <input type="checkbox"/> Calif Mod | <input type="checkbox"/> 70s Era UK | <input type="checkbox"/> Chor/Echo | <input type="checkbox"/> Delay | | |
| <input type="checkbox"/> Tube Rectifier | <input type="checkbox"/> Fuzzbox | <input type="checkbox"/> Rotating Spkr | <input type="checkbox"/> Echo | | |

| | | | | | | | |
|------|------|-----|--------|---------------|---------------|--------------|--------------|
| | | | | | | | |
| GAIN | BASS | MID | TREBLE | CHANNEL LEVEL | EFFECT ADJUST | REVERB LEVEL | REVERB DEPTH |

Preset # 9 *I think I'll call it:* _____ Set TAP for _____ beats/minute

| | | | | | |
|---|---------------------------------------|--|--------------------------------|--|-------------------------------------|
| AMP MODEL: (CHECK ONE) | <input type="checkbox"/> Clean | <input type="checkbox"/> Top Mount | EFFECT: (CHECK ONE) | <input type="checkbox"/> Comp/Echo | <input type="checkbox"/> Touch Wah |
| | <input type="checkbox"/> Acoustic | <input type="checkbox"/> High Power | | <input type="checkbox"/> Comp/Chorus | <input type="checkbox"/> Compressor |
| | <input type="checkbox"/> Blue Voodoo | <input type="checkbox"/> Studio Tweed | | <input type="checkbox"/> Comp/Flg/Echo | <input type="checkbox"/> Tremolo |
| | <input type="checkbox"/> Vintage Club | <input type="checkbox"/> Black Face | | <input type="checkbox"/> Cmp/Cho/Echo | <input type="checkbox"/> Vibrato |
| | <input type="checkbox"/> Flexwave | <input type="checkbox"/> Large Tweed | | <input type="checkbox"/> Cmp/Vib/Echo | <input type="checkbox"/> Chorus |
| | <input type="checkbox"/> Ampeg VL | <input type="checkbox"/> 60s Era UK | | <input type="checkbox"/> Flange/Echo | <input type="checkbox"/> Flanger |
| <input type="checkbox"/> Calif Mod | <input type="checkbox"/> 70s Era UK | <input type="checkbox"/> Chor/Echo | <input type="checkbox"/> Delay | | |
| <input type="checkbox"/> Tube Rectifier | <input type="checkbox"/> Fuzzbox | <input type="checkbox"/> Rotating Spkr | <input type="checkbox"/> Echo | | |

| | | | | | | | |
|------|------|-----|--------|---------------|---------------|--------------|--------------|
| | | | | | | | |
| GAIN | BASS | MID | TREBLE | CHANNEL LEVEL | EFFECT ADJUST | REVERB LEVEL | REVERB DEPTH |

Preset # 10 *I think I'll call it:* _____ Set TAP for _____ beats/minute

| | | | | | |
|---|---------------------------------------|--|--------------------------------|--|-------------------------------------|
| AMP MODEL: (CHECK ONE) | <input type="checkbox"/> Clean | <input type="checkbox"/> Top Mount | EFFECT: (CHECK ONE) | <input type="checkbox"/> Comp/Echo | <input type="checkbox"/> Touch Wah |
| | <input type="checkbox"/> Acoustic | <input type="checkbox"/> High Power | | <input type="checkbox"/> Comp/Chorus | <input type="checkbox"/> Compressor |
| | <input type="checkbox"/> Blue Voodoo | <input type="checkbox"/> Studio Tweed | | <input type="checkbox"/> Comp/Flg/Echo | <input type="checkbox"/> Tremolo |
| | <input type="checkbox"/> Vintage Club | <input type="checkbox"/> Black Face | | <input type="checkbox"/> Cmp/Cho/Echo | <input type="checkbox"/> Vibrato |
| | <input type="checkbox"/> Flexwave | <input type="checkbox"/> Large Tweed | | <input type="checkbox"/> Cmp/Vib/Echo | <input type="checkbox"/> Chorus |
| | <input type="checkbox"/> Ampeg VL | <input type="checkbox"/> 60s Era UK | | <input type="checkbox"/> Flange/Echo | <input type="checkbox"/> Flanger |
| <input type="checkbox"/> Calif Mod | <input type="checkbox"/> 70s Era UK | <input type="checkbox"/> Chor/Echo | <input type="checkbox"/> Delay | | |
| <input type="checkbox"/> Tube Rectifier | <input type="checkbox"/> Fuzzbox | <input type="checkbox"/> Rotating Spkr | <input type="checkbox"/> Echo | | |

| | | | | | | | |
|------|------|-----|--------|---------------|---------------|--------------|--------------|
| | | | | | | | |
| GAIN | BASS | MID | TREBLE | CHANNEL LEVEL | EFFECT ADJUST | REVERB LEVEL | REVERB DEPTH |

FAVORITES

CRATE DX-112/212 Digital Guitar Amplifier

USER PRESETS 11-16 - BANK A

NOTE: Presets 11-100 are only accessible through the optional Crate Foot Controller

Preset # 11 I think I'll call it: _____ Set TAP for _____ beats/minute

| | | | | | |
|---------------------------|---|---------------------------------------|------------------------|--|-------------------------------------|
| AMP MODEL: (CHECK ONE) | <input type="checkbox"/> Clean | <input type="checkbox"/> Top Mount | EFFECT: (CHECK ONE) | <input type="checkbox"/> Comp/Echo | <input type="checkbox"/> Touch Wah |
| | <input type="checkbox"/> Acoustic | <input type="checkbox"/> High Power | | <input type="checkbox"/> Comp/Chorus | <input type="checkbox"/> Compressor |
| | <input type="checkbox"/> Blue Voodoo | <input type="checkbox"/> Studio Tweed | | <input type="checkbox"/> Cmp/Flg/Echo | <input type="checkbox"/> Tremolo |
| | <input type="checkbox"/> Vintage Club | <input type="checkbox"/> Black Face | | <input type="checkbox"/> Cmp/Cho/Echo | <input type="checkbox"/> Vibrato |
| | <input type="checkbox"/> Flexwave | <input type="checkbox"/> Large Tweed | | <input type="checkbox"/> Cmp/Vib/Echo | <input type="checkbox"/> Chorus |
| | <input type="checkbox"/> Ampeg VL | <input type="checkbox"/> 60s Era UK | | <input type="checkbox"/> Flange/Echo | <input type="checkbox"/> Flanger |
| | <input type="checkbox"/> Calif Mod | <input type="checkbox"/> 70s Era UK | | <input type="checkbox"/> Chor/Echo | <input type="checkbox"/> Delay |
| | <input type="checkbox"/> Tube Rectifier | <input type="checkbox"/> Fuzzbox | | <input type="checkbox"/> Rotating Spkr | <input type="checkbox"/> Echo |

| | | | | | | | |
|------|------|-----|--------|---------------|---------------|--------------|--------------|
| | | | | | | | |
| GAIN | BASS | MID | TREBLE | CHANNEL LEVEL | EFFECT ADJUST | REVERB LEVEL | REVERB DEPTH |

Preset # 12 I think I'll call it: _____ Set TAP for _____ beats/minute

| | | | | | |
|---------------------------|---|---------------------------------------|------------------------|--|-------------------------------------|
| AMP MODEL: (CHECK ONE) | <input type="checkbox"/> Clean | <input type="checkbox"/> Top Mount | EFFECT: (CHECK ONE) | <input type="checkbox"/> Comp/Echo | <input type="checkbox"/> Touch Wah |
| | <input type="checkbox"/> Acoustic | <input type="checkbox"/> High Power | | <input type="checkbox"/> Comp/Chorus | <input type="checkbox"/> Compressor |
| | <input type="checkbox"/> Blue Voodoo | <input type="checkbox"/> Studio Tweed | | <input type="checkbox"/> Cmp/Flg/Echo | <input type="checkbox"/> Tremolo |
| | <input type="checkbox"/> Vintage Club | <input type="checkbox"/> Black Face | | <input type="checkbox"/> Cmp/Cho/Echo | <input type="checkbox"/> Vibrato |
| | <input type="checkbox"/> Flexwave | <input type="checkbox"/> Large Tweed | | <input type="checkbox"/> Cmp/Vib/Echo | <input type="checkbox"/> Chorus |
| | <input type="checkbox"/> Ampeg VL | <input type="checkbox"/> 60s Era UK | | <input type="checkbox"/> Flange/Echo | <input type="checkbox"/> Flanger |
| | <input type="checkbox"/> Calif Mod | <input type="checkbox"/> 70s Era UK | | <input type="checkbox"/> Chor/Echo | <input type="checkbox"/> Delay |
| | <input type="checkbox"/> Tube Rectifier | <input type="checkbox"/> Fuzzbox | | <input type="checkbox"/> Rotating Spkr | <input type="checkbox"/> Echo |

| | | | | | | | |
|------|------|-----|--------|---------------|---------------|--------------|--------------|
| | | | | | | | |
| GAIN | BASS | MID | TREBLE | CHANNEL LEVEL | EFFECT ADJUST | REVERB LEVEL | REVERB DEPTH |

Preset # 13 I think I'll call it: _____ Set TAP for _____ beats/minute

| | | | | | |
|---------------------------|---|---------------------------------------|------------------------|--|-------------------------------------|
| AMP MODEL: (CHECK ONE) | <input type="checkbox"/> Clean | <input type="checkbox"/> Top Mount | EFFECT: (CHECK ONE) | <input type="checkbox"/> Comp/Echo | <input type="checkbox"/> Touch Wah |
| | <input type="checkbox"/> Acoustic | <input type="checkbox"/> High Power | | <input type="checkbox"/> Comp/Chorus | <input type="checkbox"/> Compressor |
| | <input type="checkbox"/> Blue Voodoo | <input type="checkbox"/> Studio Tweed | | <input type="checkbox"/> Cmp/Flg/Echo | <input type="checkbox"/> Tremolo |
| | <input type="checkbox"/> Vintage Club | <input type="checkbox"/> Black Face | | <input type="checkbox"/> Cmp/Cho/Echo | <input type="checkbox"/> Vibrato |
| | <input type="checkbox"/> Flexwave | <input type="checkbox"/> Large Tweed | | <input type="checkbox"/> Cmp/Vib/Echo | <input type="checkbox"/> Chorus |
| | <input type="checkbox"/> Ampeg VL | <input type="checkbox"/> 60s Era UK | | <input type="checkbox"/> Flange/Echo | <input type="checkbox"/> Flanger |
| | <input type="checkbox"/> Calif Mod | <input type="checkbox"/> 70s Era UK | | <input type="checkbox"/> Chor/Echo | <input type="checkbox"/> Delay |
| | <input type="checkbox"/> Tube Rectifier | <input type="checkbox"/> Fuzzbox | | <input type="checkbox"/> Rotating Spkr | <input type="checkbox"/> Echo |

| | | | | | | | |
|------|------|-----|--------|---------------|---------------|--------------|--------------|
| | | | | | | | |
| GAIN | BASS | MID | TREBLE | CHANNEL LEVEL | EFFECT ADJUST | REVERB LEVEL | REVERB DEPTH |

Preset # 14 I think I'll call it: _____ Set TAP for _____ beats/minute

| | | | | | |
|---------------------------|---|---------------------------------------|------------------------|--|-------------------------------------|
| AMP MODEL: (CHECK ONE) | <input type="checkbox"/> Clean | <input type="checkbox"/> Top Mount | EFFECT: (CHECK ONE) | <input type="checkbox"/> Comp/Echo | <input type="checkbox"/> Touch Wah |
| | <input type="checkbox"/> Acoustic | <input type="checkbox"/> High Power | | <input type="checkbox"/> Comp/Chorus | <input type="checkbox"/> Compressor |
| | <input type="checkbox"/> Blue Voodoo | <input type="checkbox"/> Studio Tweed | | <input type="checkbox"/> Cmp/Flg/Echo | <input type="checkbox"/> Tremolo |
| | <input type="checkbox"/> Vintage Club | <input type="checkbox"/> Black Face | | <input type="checkbox"/> Cmp/Cho/Echo | <input type="checkbox"/> Vibrato |
| | <input type="checkbox"/> Flexwave | <input type="checkbox"/> Large Tweed | | <input type="checkbox"/> Cmp/Vib/Echo | <input type="checkbox"/> Chorus |
| | <input type="checkbox"/> Ampeg VL | <input type="checkbox"/> 60s Era UK | | <input type="checkbox"/> Flange/Echo | <input type="checkbox"/> Flanger |
| | <input type="checkbox"/> Calif Mod | <input type="checkbox"/> 70s Era UK | | <input type="checkbox"/> Chor/Echo | <input type="checkbox"/> Delay |
| | <input type="checkbox"/> Tube Rectifier | <input type="checkbox"/> Fuzzbox | | <input type="checkbox"/> Rotating Spkr | <input type="checkbox"/> Echo |

| | | | | | | | |
|------|------|-----|--------|---------------|---------------|--------------|--------------|
| | | | | | | | |
| GAIN | BASS | MID | TREBLE | CHANNEL LEVEL | EFFECT ADJUST | REVERB LEVEL | REVERB DEPTH |

Preset # 15 I think I'll call it: _____ Set TAP for _____ beats/minute

| | | | | | |
|---------------------------|---|---------------------------------------|------------------------|--|-------------------------------------|
| AMP MODEL: (CHECK ONE) | <input type="checkbox"/> Clean | <input type="checkbox"/> Top Mount | EFFECT: (CHECK ONE) | <input type="checkbox"/> Comp/Echo | <input type="checkbox"/> Touch Wah |
| | <input type="checkbox"/> Acoustic | <input type="checkbox"/> High Power | | <input type="checkbox"/> Comp/Chorus | <input type="checkbox"/> Compressor |
| | <input type="checkbox"/> Blue Voodoo | <input type="checkbox"/> Studio Tweed | | <input type="checkbox"/> Cmp/Flg/Echo | <input type="checkbox"/> Tremolo |
| | <input type="checkbox"/> Vintage Club | <input type="checkbox"/> Black Face | | <input type="checkbox"/> Cmp/Cho/Echo | <input type="checkbox"/> Vibrato |
| | <input type="checkbox"/> Flexwave | <input type="checkbox"/> Large Tweed | | <input type="checkbox"/> Cmp/Vib/Echo | <input type="checkbox"/> Chorus |
| | <input type="checkbox"/> Ampeg VL | <input type="checkbox"/> 60s Era UK | | <input type="checkbox"/> Flange/Echo | <input type="checkbox"/> Flanger |
| | <input type="checkbox"/> Calif Mod | <input type="checkbox"/> 70s Era UK | | <input type="checkbox"/> Chor/Echo | <input type="checkbox"/> Delay |
| | <input type="checkbox"/> Tube Rectifier | <input type="checkbox"/> Fuzzbox | | <input type="checkbox"/> Rotating Spkr | <input type="checkbox"/> Echo |

| | | | | | | | |
|------|------|-----|--------|---------------|---------------|--------------|--------------|
| | | | | | | | |
| GAIN | BASS | MID | TREBLE | CHANNEL LEVEL | EFFECT ADJUST | REVERB LEVEL | REVERB DEPTH |

FAVORITES

DX-112/212 Digital Guitar Amplifier **CRATE**

USER PRESETS 16–20 - BANK B

Preset # 16 *I think I'll call it:* _____ Set TAP for _____ beats/minute

| | | |
|---|---------------------------------------|---------------------------------------|
| AMP MODEL: (CHECK ONE) | <input type="checkbox"/> Clean | <input type="checkbox"/> Top Mount |
| | <input type="checkbox"/> Acoustic | <input type="checkbox"/> High Power |
| | <input type="checkbox"/> Blue Voodoo | <input type="checkbox"/> Studio Tweed |
| | <input type="checkbox"/> Vintage Club | <input type="checkbox"/> Black Face |
| | <input type="checkbox"/> Flexwave | <input type="checkbox"/> Large Tweed |
| | <input type="checkbox"/> Ampeg VL | <input type="checkbox"/> 60s Era UK |
| <input type="checkbox"/> Calif Mod | <input type="checkbox"/> 70s Era UK | |
| <input type="checkbox"/> Tube Rectifier | <input type="checkbox"/> Fuzzbox | |

EFFECT: (CHECK ONE)

| | |
|--|-------------------------------------|
| <input type="checkbox"/> Comp/Echo | <input type="checkbox"/> Touch Wah |
| <input type="checkbox"/> Comp/Chorus | <input type="checkbox"/> Compressor |
| <input type="checkbox"/> Comp/Flg/Echo | <input type="checkbox"/> Tremolo |
| <input type="checkbox"/> Cmp/Cho/Echo | <input type="checkbox"/> Vibrato |
| <input type="checkbox"/> Cmp/Vib/Echo | <input type="checkbox"/> Chorus |
| <input type="checkbox"/> Flange/Echo | <input type="checkbox"/> Flanger |
| <input type="checkbox"/> Chor/Echo | <input type="checkbox"/> Delay |
| <input type="checkbox"/> Rotating Spkr | <input type="checkbox"/> Echo |



GAIN



BASS



MID



TREBLE



CHANNEL
LEVEL



EFFECT
ADJUST



REVERB
LEVEL



REVERB
DEPTH

Preset # 17 *I think I'll call it:* _____ Set TAP for _____ beats/minute

| | | |
|---|---------------------------------------|---------------------------------------|
| AMP MODEL: (CHECK ONE) | <input type="checkbox"/> Clean | <input type="checkbox"/> Top Mount |
| | <input type="checkbox"/> Acoustic | <input type="checkbox"/> High Power |
| | <input type="checkbox"/> Blue Voodoo | <input type="checkbox"/> Studio Tweed |
| | <input type="checkbox"/> Vintage Club | <input type="checkbox"/> Black Face |
| | <input type="checkbox"/> Flexwave | <input type="checkbox"/> Large Tweed |
| | <input type="checkbox"/> Ampeg VL | <input type="checkbox"/> 60s Era UK |
| <input type="checkbox"/> Calif Mod | <input type="checkbox"/> 70s Era UK | |
| <input type="checkbox"/> Tube Rectifier | <input type="checkbox"/> Fuzzbox | |

EFFECT: (CHECK ONE)

| | |
|--|-------------------------------------|
| <input type="checkbox"/> Comp/Echo | <input type="checkbox"/> Touch Wah |
| <input type="checkbox"/> Comp/Chorus | <input type="checkbox"/> Compressor |
| <input type="checkbox"/> Comp/Flg/Echo | <input type="checkbox"/> Tremolo |
| <input type="checkbox"/> Cmp/Cho/Echo | <input type="checkbox"/> Vibrato |
| <input type="checkbox"/> Cmp/Vib/Echo | <input type="checkbox"/> Chorus |
| <input type="checkbox"/> Flange/Echo | <input type="checkbox"/> Flanger |
| <input type="checkbox"/> Chor/Echo | <input type="checkbox"/> Delay |
| <input type="checkbox"/> Rotating Spkr | <input type="checkbox"/> Echo |



GAIN



BASS



MID



TREBLE



CHANNEL
LEVEL



EFFECT
ADJUST



REVERB
LEVEL



REVERB
DEPTH

Preset # 18 *I think I'll call it:* _____ Set TAP for _____ beats/minute

| | | |
|---|---------------------------------------|---------------------------------------|
| AMP MODEL: (CHECK ONE) | <input type="checkbox"/> Clean | <input type="checkbox"/> Top Mount |
| | <input type="checkbox"/> Acoustic | <input type="checkbox"/> High Power |
| | <input type="checkbox"/> Blue Voodoo | <input type="checkbox"/> Studio Tweed |
| | <input type="checkbox"/> Vintage Club | <input type="checkbox"/> Black Face |
| | <input type="checkbox"/> Flexwave | <input type="checkbox"/> Large Tweed |
| | <input type="checkbox"/> Ampeg VL | <input type="checkbox"/> 60s Era UK |
| <input type="checkbox"/> Calif Mod | <input type="checkbox"/> 70s Era UK | |
| <input type="checkbox"/> Tube Rectifier | <input type="checkbox"/> Fuzzbox | |

EFFECT: (CHECK ONE)

| | |
|--|-------------------------------------|
| <input type="checkbox"/> Comp/Echo | <input type="checkbox"/> Touch Wah |
| <input type="checkbox"/> Comp/Chorus | <input type="checkbox"/> Compressor |
| <input type="checkbox"/> Comp/Flg/Echo | <input type="checkbox"/> Tremolo |
| <input type="checkbox"/> Cmp/Cho/Echo | <input type="checkbox"/> Vibrato |
| <input type="checkbox"/> Cmp/Vib/Echo | <input type="checkbox"/> Chorus |
| <input type="checkbox"/> Flange/Echo | <input type="checkbox"/> Flanger |
| <input type="checkbox"/> Chor/Echo | <input type="checkbox"/> Delay |
| <input type="checkbox"/> Rotating Spkr | <input type="checkbox"/> Echo |



GAIN



BASS



MID



TREBLE



CHANNEL
LEVEL



EFFECT
ADJUST



REVERB
LEVEL



REVERB
DEPTH

Preset # 19 *I think I'll call it:* _____ Set TAP for _____ beats/minute

| | | |
|---|---------------------------------------|---------------------------------------|
| AMP MODEL: (CHECK ONE) | <input type="checkbox"/> Clean | <input type="checkbox"/> Top Mount |
| | <input type="checkbox"/> Acoustic | <input type="checkbox"/> High Power |
| | <input type="checkbox"/> Blue Voodoo | <input type="checkbox"/> Studio Tweed |
| | <input type="checkbox"/> Vintage Club | <input type="checkbox"/> Black Face |
| | <input type="checkbox"/> Flexwave | <input type="checkbox"/> Large Tweed |
| | <input type="checkbox"/> Ampeg VL | <input type="checkbox"/> 60s Era UK |
| <input type="checkbox"/> Calif Mod | <input type="checkbox"/> 70s Era UK | |
| <input type="checkbox"/> Tube Rectifier | <input type="checkbox"/> Fuzzbox | |

EFFECT: (CHECK ONE)

| | |
|--|-------------------------------------|
| <input type="checkbox"/> Comp/Echo | <input type="checkbox"/> Touch Wah |
| <input type="checkbox"/> Comp/Chorus | <input type="checkbox"/> Compressor |
| <input type="checkbox"/> Comp/Flg/Echo | <input type="checkbox"/> Tremolo |
| <input type="checkbox"/> Cmp/Cho/Echo | <input type="checkbox"/> Vibrato |
| <input type="checkbox"/> Cmp/Vib/Echo | <input type="checkbox"/> Chorus |
| <input type="checkbox"/> Flange/Echo | <input type="checkbox"/> Flanger |
| <input type="checkbox"/> Chor/Echo | <input type="checkbox"/> Delay |
| <input type="checkbox"/> Rotating Spkr | <input type="checkbox"/> Echo |



GAIN



BASS



MID



TREBLE



CHANNEL
LEVEL



EFFECT
ADJUST



REVERB
LEVEL



REVERB
DEPTH

Preset # 20 *I think I'll call it:* _____ Set TAP for _____ beats/minute

| | | |
|---|---------------------------------------|---------------------------------------|
| AMP MODEL: (CHECK ONE) | <input type="checkbox"/> Clean | <input type="checkbox"/> Top Mount |
| | <input type="checkbox"/> Acoustic | <input type="checkbox"/> High Power |
| | <input type="checkbox"/> Blue Voodoo | <input type="checkbox"/> Studio Tweed |
| | <input type="checkbox"/> Vintage Club | <input type="checkbox"/> Black Face |
| | <input type="checkbox"/> Flexwave | <input type="checkbox"/> Large Tweed |
| | <input type="checkbox"/> Ampeg VL | <input type="checkbox"/> 60s Era UK |
| <input type="checkbox"/> Calif Mod | <input type="checkbox"/> 70s Era UK | |
| <input type="checkbox"/> Tube Rectifier | <input type="checkbox"/> Fuzzbox | |

EFFECT: (CHECK ONE)

| | |
|--|-------------------------------------|
| <input type="checkbox"/> Comp/Echo | <input type="checkbox"/> Touch Wah |
| <input type="checkbox"/> Comp/Chorus | <input type="checkbox"/> Compressor |
| <input type="checkbox"/> Comp/Flg/Echo | <input type="checkbox"/> Tremolo |
| <input type="checkbox"/> Cmp/Cho/Echo | <input type="checkbox"/> Vibrato |
| <input type="checkbox"/> Cmp/Vib/Echo | <input type="checkbox"/> Chorus |
| <input type="checkbox"/> Flange/Echo | <input type="checkbox"/> Flanger |
| <input type="checkbox"/> Chor/Echo | <input type="checkbox"/> Delay |
| <input type="checkbox"/> Rotating Spkr | <input type="checkbox"/> Echo |



GAIN



BASS



MID



TREBLE



CHANNEL
LEVEL



EFFECT
ADJUST



REVERB
LEVEL



REVERB
DEPTH

FAVORITES

CRATE DX-112/212 Digital Guitar Amplifier

USER PRESETS 21-25 - BANK A

Preset # 21 *I think I'll call it:* _____ Set TAP for _____ beats/minute

| | | | | | |
|---------------------------|---|---------------------------------------|------------------------|--|-------------------------------------|
| AMP MODEL: (CHECK ONE) | <input type="checkbox"/> Clean | <input type="checkbox"/> Top Mount | EFFECT: (CHECK ONE) | <input type="checkbox"/> Comp/Echo | <input type="checkbox"/> Touch Wah |
| | <input type="checkbox"/> Acoustic | <input type="checkbox"/> High Power | | <input type="checkbox"/> Comp/Chorus | <input type="checkbox"/> Compressor |
| | <input type="checkbox"/> Blue Voodoo | <input type="checkbox"/> Studio Tweed | | <input type="checkbox"/> Cmp/Fly/Echo | <input type="checkbox"/> Tremolo |
| | <input type="checkbox"/> Vintage Club | <input type="checkbox"/> Black Face | | <input type="checkbox"/> Cmp/Cho/Echo | <input type="checkbox"/> Vibrato |
| | <input type="checkbox"/> Flexwave | <input type="checkbox"/> Large Tweed | | <input type="checkbox"/> Cmp/Vib/Echo | <input type="checkbox"/> Chorus |
| | <input type="checkbox"/> Ampeg VL | <input type="checkbox"/> 60s Era UK | | <input type="checkbox"/> Flange/Echo | <input type="checkbox"/> Flanger |
| | <input type="checkbox"/> Calif Mod | <input type="checkbox"/> 70s Era UK | | <input type="checkbox"/> Chor/Echo | <input type="checkbox"/> Delay |
| | <input type="checkbox"/> Tube Rectifier | <input type="checkbox"/> Fuzzbox | | <input type="checkbox"/> Rotating Spkr | <input type="checkbox"/> Echo |

| | | | | | | | |
|------|------|-----|--------|---------------|---------------|--------------|--------------|
| | | | | | | | |
| GAIN | BASS | MID | TREBLE | CHANNEL LEVEL | EFFECT ADJUST | REVERB LEVEL | REVERB DEPTH |

Preset # 22 *I think I'll call it:* _____ Set TAP for _____ beats/minute

| | | | | | |
|---------------------------|---|---------------------------------------|------------------------|--|-------------------------------------|
| AMP MODEL: (CHECK ONE) | <input type="checkbox"/> Clean | <input type="checkbox"/> Top Mount | EFFECT: (CHECK ONE) | <input type="checkbox"/> Comp/Echo | <input type="checkbox"/> Touch Wah |
| | <input type="checkbox"/> Acoustic | <input type="checkbox"/> High Power | | <input type="checkbox"/> Comp/Chorus | <input type="checkbox"/> Compressor |
| | <input type="checkbox"/> Blue Voodoo | <input type="checkbox"/> Studio Tweed | | <input type="checkbox"/> Cmp/Fly/Echo | <input type="checkbox"/> Tremolo |
| | <input type="checkbox"/> Vintage Club | <input type="checkbox"/> Black Face | | <input type="checkbox"/> Cmp/Cho/Echo | <input type="checkbox"/> Vibrato |
| | <input type="checkbox"/> Flexwave | <input type="checkbox"/> Large Tweed | | <input type="checkbox"/> Cmp/Vib/Echo | <input type="checkbox"/> Chorus |
| | <input type="checkbox"/> Ampeg VL | <input type="checkbox"/> 60s Era UK | | <input type="checkbox"/> Flange/Echo | <input type="checkbox"/> Flanger |
| | <input type="checkbox"/> Calif Mod | <input type="checkbox"/> 70s Era UK | | <input type="checkbox"/> Chor/Echo | <input type="checkbox"/> Delay |
| | <input type="checkbox"/> Tube Rectifier | <input type="checkbox"/> Fuzzbox | | <input type="checkbox"/> Rotating Spkr | <input type="checkbox"/> Echo |

| | | | | | | | |
|------|------|-----|--------|---------------|---------------|--------------|--------------|
| | | | | | | | |
| GAIN | BASS | MID | TREBLE | CHANNEL LEVEL | EFFECT ADJUST | REVERB LEVEL | REVERB DEPTH |

Preset # 23 *I think I'll call it:* _____ Set TAP for _____ beats/minute

| | | | | | |
|---------------------------|---|---------------------------------------|------------------------|--|-------------------------------------|
| AMP MODEL: (CHECK ONE) | <input type="checkbox"/> Clean | <input type="checkbox"/> Top Mount | EFFECT: (CHECK ONE) | <input type="checkbox"/> Comp/Echo | <input type="checkbox"/> Touch Wah |
| | <input type="checkbox"/> Acoustic | <input type="checkbox"/> High Power | | <input type="checkbox"/> Comp/Chorus | <input type="checkbox"/> Compressor |
| | <input type="checkbox"/> Blue Voodoo | <input type="checkbox"/> Studio Tweed | | <input type="checkbox"/> Cmp/Fly/Echo | <input type="checkbox"/> Tremolo |
| | <input type="checkbox"/> Vintage Club | <input type="checkbox"/> Black Face | | <input type="checkbox"/> Cmp/Cho/Echo | <input type="checkbox"/> Vibrato |
| | <input type="checkbox"/> Flexwave | <input type="checkbox"/> Large Tweed | | <input type="checkbox"/> Cmp/Vib/Echo | <input type="checkbox"/> Chorus |
| | <input type="checkbox"/> Ampeg VL | <input type="checkbox"/> 60s Era UK | | <input type="checkbox"/> Flange/Echo | <input type="checkbox"/> Flanger |
| | <input type="checkbox"/> Calif Mod | <input type="checkbox"/> 70s Era UK | | <input type="checkbox"/> Chor/Echo | <input type="checkbox"/> Delay |
| | <input type="checkbox"/> Tube Rectifier | <input type="checkbox"/> Fuzzbox | | <input type="checkbox"/> Rotating Spkr | <input type="checkbox"/> Echo |

| | | | | | | | |
|------|------|-----|--------|---------------|---------------|--------------|--------------|
| | | | | | | | |
| GAIN | BASS | MID | TREBLE | CHANNEL LEVEL | EFFECT ADJUST | REVERB LEVEL | REVERB DEPTH |

Preset # 24 *I think I'll call it:* _____ Set TAP for _____ beats/minute

| | | | | | |
|---------------------------|---|---------------------------------------|------------------------|--|-------------------------------------|
| AMP MODEL: (CHECK ONE) | <input type="checkbox"/> Clean | <input type="checkbox"/> Top Mount | EFFECT: (CHECK ONE) | <input type="checkbox"/> Comp/Echo | <input type="checkbox"/> Touch Wah |
| | <input type="checkbox"/> Acoustic | <input type="checkbox"/> High Power | | <input type="checkbox"/> Comp/Chorus | <input type="checkbox"/> Compressor |
| | <input type="checkbox"/> Blue Voodoo | <input type="checkbox"/> Studio Tweed | | <input type="checkbox"/> Cmp/Fly/Echo | <input type="checkbox"/> Tremolo |
| | <input type="checkbox"/> Vintage Club | <input type="checkbox"/> Black Face | | <input type="checkbox"/> Cmp/Cho/Echo | <input type="checkbox"/> Vibrato |
| | <input type="checkbox"/> Flexwave | <input type="checkbox"/> Large Tweed | | <input type="checkbox"/> Cmp/Vib/Echo | <input type="checkbox"/> Chorus |
| | <input type="checkbox"/> Ampeg VL | <input type="checkbox"/> 60s Era UK | | <input type="checkbox"/> Flange/Echo | <input type="checkbox"/> Flanger |
| | <input type="checkbox"/> Calif Mod | <input type="checkbox"/> 70s Era UK | | <input type="checkbox"/> Chor/Echo | <input type="checkbox"/> Delay |
| | <input type="checkbox"/> Tube Rectifier | <input type="checkbox"/> Fuzzbox | | <input type="checkbox"/> Rotating Spkr | <input type="checkbox"/> Echo |

| | | | | | | | |
|------|------|-----|--------|---------------|---------------|--------------|--------------|
| | | | | | | | |
| GAIN | BASS | MID | TREBLE | CHANNEL LEVEL | EFFECT ADJUST | REVERB LEVEL | REVERB DEPTH |

Preset # 25 *I think I'll call it:* _____ Set TAP for _____ beats/minute

| | | | | | |
|---------------------------|---|---------------------------------------|------------------------|--|-------------------------------------|
| AMP MODEL: (CHECK ONE) | <input type="checkbox"/> Clean | <input type="checkbox"/> Top Mount | EFFECT: (CHECK ONE) | <input type="checkbox"/> Comp/Echo | <input type="checkbox"/> Touch Wah |
| | <input type="checkbox"/> Acoustic | <input type="checkbox"/> High Power | | <input type="checkbox"/> Comp/Chorus | <input type="checkbox"/> Compressor |
| | <input type="checkbox"/> Blue Voodoo | <input type="checkbox"/> Studio Tweed | | <input type="checkbox"/> Cmp/Fly/Echo | <input type="checkbox"/> Tremolo |
| | <input type="checkbox"/> Vintage Club | <input type="checkbox"/> Black Face | | <input type="checkbox"/> Cmp/Cho/Echo | <input type="checkbox"/> Vibrato |
| | <input type="checkbox"/> Flexwave | <input type="checkbox"/> Large Tweed | | <input type="checkbox"/> Cmp/Vib/Echo | <input type="checkbox"/> Chorus |
| | <input type="checkbox"/> Ampeg VL | <input type="checkbox"/> 60s Era UK | | <input type="checkbox"/> Flange/Echo | <input type="checkbox"/> Flanger |
| | <input type="checkbox"/> Calif Mod | <input type="checkbox"/> 70s Era UK | | <input type="checkbox"/> Chor/Echo | <input type="checkbox"/> Delay |
| | <input type="checkbox"/> Tube Rectifier | <input type="checkbox"/> Fuzzbox | | <input type="checkbox"/> Rotating Spkr | <input type="checkbox"/> Echo |

| | | | | | | | |
|------|------|-----|--------|---------------|---------------|--------------|--------------|
| | | | | | | | |
| GAIN | BASS | MID | TREBLE | CHANNEL LEVEL | EFFECT ADJUST | REVERB LEVEL | REVERB DEPTH |

FAVORITES

DX-112/212 Digital Guitar Amplifier



USER PRESETS 26–30 - BANK B

Preset # 26 *I think I'll call it:* _____ Set TAP for _____ beats/minute

| | | | | | |
|---|---------------------------------------|--|-------------------------------|--|-------------------------------------|
| AMP MODEL: (CHECK ONE) | <input type="checkbox"/> Clean | <input type="checkbox"/> Top Mount | EFFECT: (CHECK ONE) | <input type="checkbox"/> Comp/Echo | <input type="checkbox"/> Touch Wah |
| | <input type="checkbox"/> Acoustic | <input type="checkbox"/> High Power | | <input type="checkbox"/> Comp/Chorus | <input type="checkbox"/> Compressor |
| | <input type="checkbox"/> Blue Voodoo | <input type="checkbox"/> Studio Tweed | | <input type="checkbox"/> Comp/Flg/Echo | <input type="checkbox"/> Tremolo |
| | <input type="checkbox"/> Vintage Club | <input type="checkbox"/> Black Face | | <input type="checkbox"/> Cmp/Cho/Echo | <input type="checkbox"/> Vibrato |
| | <input type="checkbox"/> Flexwave | <input type="checkbox"/> Large Tweed | | <input type="checkbox"/> Cmp/Vib/Echo | <input type="checkbox"/> Chorus |
| | <input type="checkbox"/> Ampeg VL | <input type="checkbox"/> 60s Era UK | | <input type="checkbox"/> Flange/Echo | <input type="checkbox"/> Flanger |
| | <input type="checkbox"/> Calif Mod | <input type="checkbox"/> 70s Era UK | | <input type="checkbox"/> Chor/Echo | <input type="checkbox"/> Delay |
| <input type="checkbox"/> Tube Rectifier | <input type="checkbox"/> Fuzzbox | <input type="checkbox"/> Rotating Spkr | <input type="checkbox"/> Echo | | |

| | | | | | | | |
|------|------|-----|--------|---------------|---------------|--------------|--------------|
| | | | | | | | |
| GAIN | BASS | MID | TREBLE | CHANNEL LEVEL | EFFECT ADJUST | REVERB LEVEL | REVERB DEPTH |

Preset # 27 *I think I'll call it:* _____ Set TAP for _____ beats/minute

| | | | | | |
|---|---------------------------------------|--|-------------------------------|--|-------------------------------------|
| AMP MODEL: (CHECK ONE) | <input type="checkbox"/> Clean | <input type="checkbox"/> Top Mount | EFFECT: (CHECK ONE) | <input type="checkbox"/> Comp/Echo | <input type="checkbox"/> Touch Wah |
| | <input type="checkbox"/> Acoustic | <input type="checkbox"/> High Power | | <input type="checkbox"/> Comp/Chorus | <input type="checkbox"/> Compressor |
| | <input type="checkbox"/> Blue Voodoo | <input type="checkbox"/> Studio Tweed | | <input type="checkbox"/> Comp/Flg/Echo | <input type="checkbox"/> Tremolo |
| | <input type="checkbox"/> Vintage Club | <input type="checkbox"/> Black Face | | <input type="checkbox"/> Cmp/Cho/Echo | <input type="checkbox"/> Vibrato |
| | <input type="checkbox"/> Flexwave | <input type="checkbox"/> Large Tweed | | <input type="checkbox"/> Cmp/Vib/Echo | <input type="checkbox"/> Chorus |
| | <input type="checkbox"/> Ampeg VL | <input type="checkbox"/> 60s Era UK | | <input type="checkbox"/> Flange/Echo | <input type="checkbox"/> Flanger |
| | <input type="checkbox"/> Calif Mod | <input type="checkbox"/> 70s Era UK | | <input type="checkbox"/> Chor/Echo | <input type="checkbox"/> Delay |
| <input type="checkbox"/> Tube Rectifier | <input type="checkbox"/> Fuzzbox | <input type="checkbox"/> Rotating Spkr | <input type="checkbox"/> Echo | | |

| | | | | | | | |
|------|------|-----|--------|---------------|---------------|--------------|--------------|
| | | | | | | | |
| GAIN | BASS | MID | TREBLE | CHANNEL LEVEL | EFFECT ADJUST | REVERB LEVEL | REVERB DEPTH |

Preset # 28 *I think I'll call it:* _____ Set TAP for _____ beats/minute

| | | | | | |
|---|---------------------------------------|--|-------------------------------|--|-------------------------------------|
| AMP MODEL: (CHECK ONE) | <input type="checkbox"/> Clean | <input type="checkbox"/> Top Mount | EFFECT: (CHECK ONE) | <input type="checkbox"/> Comp/Echo | <input type="checkbox"/> Touch Wah |
| | <input type="checkbox"/> Acoustic | <input type="checkbox"/> High Power | | <input type="checkbox"/> Comp/Chorus | <input type="checkbox"/> Compressor |
| | <input type="checkbox"/> Blue Voodoo | <input type="checkbox"/> Studio Tweed | | <input type="checkbox"/> Comp/Flg/Echo | <input type="checkbox"/> Tremolo |
| | <input type="checkbox"/> Vintage Club | <input type="checkbox"/> Black Face | | <input type="checkbox"/> Cmp/Cho/Echo | <input type="checkbox"/> Vibrato |
| | <input type="checkbox"/> Flexwave | <input type="checkbox"/> Large Tweed | | <input type="checkbox"/> Cmp/Vib/Echo | <input type="checkbox"/> Chorus |
| | <input type="checkbox"/> Ampeg VL | <input type="checkbox"/> 60s Era UK | | <input type="checkbox"/> Flange/Echo | <input type="checkbox"/> Flanger |
| | <input type="checkbox"/> Calif Mod | <input type="checkbox"/> 70s Era UK | | <input type="checkbox"/> Chor/Echo | <input type="checkbox"/> Delay |
| <input type="checkbox"/> Tube Rectifier | <input type="checkbox"/> Fuzzbox | <input type="checkbox"/> Rotating Spkr | <input type="checkbox"/> Echo | | |

| | | | | | | | |
|------|------|-----|--------|---------------|---------------|--------------|--------------|
| | | | | | | | |
| GAIN | BASS | MID | TREBLE | CHANNEL LEVEL | EFFECT ADJUST | REVERB LEVEL | REVERB DEPTH |

Preset # 29 *I think I'll call it:* _____ Set TAP for _____ beats/minute

| | | | | | |
|---|---------------------------------------|--|-------------------------------|--|-------------------------------------|
| AMP MODEL: (CHECK ONE) | <input type="checkbox"/> Clean | <input type="checkbox"/> Top Mount | EFFECT: (CHECK ONE) | <input type="checkbox"/> Comp/Echo | <input type="checkbox"/> Touch Wah |
| | <input type="checkbox"/> Acoustic | <input type="checkbox"/> High Power | | <input type="checkbox"/> Comp/Chorus | <input type="checkbox"/> Compressor |
| | <input type="checkbox"/> Blue Voodoo | <input type="checkbox"/> Studio Tweed | | <input type="checkbox"/> Comp/Flg/Echo | <input type="checkbox"/> Tremolo |
| | <input type="checkbox"/> Vintage Club | <input type="checkbox"/> Black Face | | <input type="checkbox"/> Cmp/Cho/Echo | <input type="checkbox"/> Vibrato |
| | <input type="checkbox"/> Flexwave | <input type="checkbox"/> Large Tweed | | <input type="checkbox"/> Cmp/Vib/Echo | <input type="checkbox"/> Chorus |
| | <input type="checkbox"/> Ampeg VL | <input type="checkbox"/> 60s Era UK | | <input type="checkbox"/> Flange/Echo | <input type="checkbox"/> Flanger |
| | <input type="checkbox"/> Calif Mod | <input type="checkbox"/> 70s Era UK | | <input type="checkbox"/> Chor/Echo | <input type="checkbox"/> Delay |
| <input type="checkbox"/> Tube Rectifier | <input type="checkbox"/> Fuzzbox | <input type="checkbox"/> Rotating Spkr | <input type="checkbox"/> Echo | | |

| | | | | | | | |
|------|------|-----|--------|---------------|---------------|--------------|--------------|
| | | | | | | | |
| GAIN | BASS | MID | TREBLE | CHANNEL LEVEL | EFFECT ADJUST | REVERB LEVEL | REVERB DEPTH |

Preset # 30 *I think I'll call it:* _____ Set TAP for _____ beats/minute

| | | | | | |
|---|---------------------------------------|--|-------------------------------|--|-------------------------------------|
| AMP MODEL: (CHECK ONE) | <input type="checkbox"/> Clean | <input type="checkbox"/> Top Mount | EFFECT: (CHECK ONE) | <input type="checkbox"/> Comp/Echo | <input type="checkbox"/> Touch Wah |
| | <input type="checkbox"/> Acoustic | <input type="checkbox"/> High Power | | <input type="checkbox"/> Comp/Chorus | <input type="checkbox"/> Compressor |
| | <input type="checkbox"/> Blue Voodoo | <input type="checkbox"/> Studio Tweed | | <input type="checkbox"/> Comp/Flg/Echo | <input type="checkbox"/> Tremolo |
| | <input type="checkbox"/> Vintage Club | <input type="checkbox"/> Black Face | | <input type="checkbox"/> Cmp/Cho/Echo | <input type="checkbox"/> Vibrato |
| | <input type="checkbox"/> Flexwave | <input type="checkbox"/> Large Tweed | | <input type="checkbox"/> Cmp/Vib/Echo | <input type="checkbox"/> Chorus |
| | <input type="checkbox"/> Ampeg VL | <input type="checkbox"/> 60s Era UK | | <input type="checkbox"/> Flange/Echo | <input type="checkbox"/> Flanger |
| | <input type="checkbox"/> Calif Mod | <input type="checkbox"/> 70s Era UK | | <input type="checkbox"/> Chor/Echo | <input type="checkbox"/> Delay |
| <input type="checkbox"/> Tube Rectifier | <input type="checkbox"/> Fuzzbox | <input type="checkbox"/> Rotating Spkr | <input type="checkbox"/> Echo | | |

| | | | | | | | |
|------|------|-----|--------|---------------|---------------|--------------|--------------|
| | | | | | | | |
| GAIN | BASS | MID | TREBLE | CHANNEL LEVEL | EFFECT ADJUST | REVERB LEVEL | REVERB DEPTH |

FAVORITES

CRATE DX-112/212 Digital Guitar Amplifier

USER PRESETS 31–35 - BANK A

Preset # 31 *I think I'll call it:* _____ Set TAP for _____ beats/minute

| | | | | | |
|---------------------------|---|---------------------------------------|------------------------|--|-------------------------------------|
| AMP MODEL: (CHECK ONE) | <input type="checkbox"/> Clean | <input type="checkbox"/> Top Mount | EFFECT: (CHECK ONE) | <input type="checkbox"/> Comp/Echo | <input type="checkbox"/> Touch Wah |
| | <input type="checkbox"/> Acoustic | <input type="checkbox"/> High Power | | <input type="checkbox"/> Comp/Chorus | <input type="checkbox"/> Compressor |
| | <input type="checkbox"/> Blue Voodoo | <input type="checkbox"/> Studio Tweed | | <input type="checkbox"/> Cmp/Fly/Echo | <input type="checkbox"/> Tremolo |
| | <input type="checkbox"/> Vintage Club | <input type="checkbox"/> Black Face | | <input type="checkbox"/> Cmp/Cho/Echo | <input type="checkbox"/> Vibrato |
| | <input type="checkbox"/> Flexwave | <input type="checkbox"/> Large Tweed | | <input type="checkbox"/> Cmp/Vib/Echo | <input type="checkbox"/> Chorus |
| | <input type="checkbox"/> Ampeg VL | <input type="checkbox"/> 60s Era UK | | <input type="checkbox"/> Flange/Echo | <input type="checkbox"/> Flanger |
| | <input type="checkbox"/> Calif Mod | <input type="checkbox"/> 70s Era UK | | <input type="checkbox"/> Chor/Echo | <input type="checkbox"/> Delay |
| | <input type="checkbox"/> Tube Rectifier | <input type="checkbox"/> Fuzzbox | | <input type="checkbox"/> Rotating Spkr | <input type="checkbox"/> Echo |

| | | | | | | | |
|------|------|-----|--------|---------------|---------------|--------------|--------------|
| | | | | | | | |
| GAIN | BASS | MID | TREBLE | CHANNEL LEVEL | EFFECT ADJUST | REVERB LEVEL | REVERB DEPTH |

Preset # 32 *I think I'll call it:* _____ Set TAP for _____ beats/minute

| | | | | | |
|---------------------------|---|---------------------------------------|------------------------|--|-------------------------------------|
| AMP MODEL: (CHECK ONE) | <input type="checkbox"/> Clean | <input type="checkbox"/> Top Mount | EFFECT: (CHECK ONE) | <input type="checkbox"/> Comp/Echo | <input type="checkbox"/> Touch Wah |
| | <input type="checkbox"/> Acoustic | <input type="checkbox"/> High Power | | <input type="checkbox"/> Comp/Chorus | <input type="checkbox"/> Compressor |
| | <input type="checkbox"/> Blue Voodoo | <input type="checkbox"/> Studio Tweed | | <input type="checkbox"/> Cmp/Fly/Echo | <input type="checkbox"/> Tremolo |
| | <input type="checkbox"/> Vintage Club | <input type="checkbox"/> Black Face | | <input type="checkbox"/> Cmp/Cho/Echo | <input type="checkbox"/> Vibrato |
| | <input type="checkbox"/> Flexwave | <input type="checkbox"/> Large Tweed | | <input type="checkbox"/> Cmp/Vib/Echo | <input type="checkbox"/> Chorus |
| | <input type="checkbox"/> Ampeg VL | <input type="checkbox"/> 60s Era UK | | <input type="checkbox"/> Flange/Echo | <input type="checkbox"/> Flanger |
| | <input type="checkbox"/> Calif Mod | <input type="checkbox"/> 70s Era UK | | <input type="checkbox"/> Chor/Echo | <input type="checkbox"/> Delay |
| | <input type="checkbox"/> Tube Rectifier | <input type="checkbox"/> Fuzzbox | | <input type="checkbox"/> Rotating Spkr | <input type="checkbox"/> Echo |

| | | | | | | | |
|------|------|-----|--------|---------------|---------------|--------------|--------------|
| | | | | | | | |
| GAIN | BASS | MID | TREBLE | CHANNEL LEVEL | EFFECT ADJUST | REVERB LEVEL | REVERB DEPTH |

Preset # 33 *I think I'll call it:* _____ Set TAP for _____ beats/minute

| | | | | | |
|---------------------------|---|---------------------------------------|------------------------|--|-------------------------------------|
| AMP MODEL: (CHECK ONE) | <input type="checkbox"/> Clean | <input type="checkbox"/> Top Mount | EFFECT: (CHECK ONE) | <input type="checkbox"/> Comp/Echo | <input type="checkbox"/> Touch Wah |
| | <input type="checkbox"/> Acoustic | <input type="checkbox"/> High Power | | <input type="checkbox"/> Comp/Chorus | <input type="checkbox"/> Compressor |
| | <input type="checkbox"/> Blue Voodoo | <input type="checkbox"/> Studio Tweed | | <input type="checkbox"/> Cmp/Fly/Echo | <input type="checkbox"/> Tremolo |
| | <input type="checkbox"/> Vintage Club | <input type="checkbox"/> Black Face | | <input type="checkbox"/> Cmp/Cho/Echo | <input type="checkbox"/> Vibrato |
| | <input type="checkbox"/> Flexwave | <input type="checkbox"/> Large Tweed | | <input type="checkbox"/> Cmp/Vib/Echo | <input type="checkbox"/> Chorus |
| | <input type="checkbox"/> Ampeg VL | <input type="checkbox"/> 60s Era UK | | <input type="checkbox"/> Flange/Echo | <input type="checkbox"/> Flanger |
| | <input type="checkbox"/> Calif Mod | <input type="checkbox"/> 70s Era UK | | <input type="checkbox"/> Chor/Echo | <input type="checkbox"/> Delay |
| | <input type="checkbox"/> Tube Rectifier | <input type="checkbox"/> Fuzzbox | | <input type="checkbox"/> Rotating Spkr | <input type="checkbox"/> Echo |

| | | | | | | | |
|------|------|-----|--------|---------------|---------------|--------------|--------------|
| | | | | | | | |
| GAIN | BASS | MID | TREBLE | CHANNEL LEVEL | EFFECT ADJUST | REVERB LEVEL | REVERB DEPTH |

Preset # 34 *I think I'll call it:* _____ Set TAP for _____ beats/minute

| | | | | | |
|---------------------------|---|---------------------------------------|------------------------|--|-------------------------------------|
| AMP MODEL: (CHECK ONE) | <input type="checkbox"/> Clean | <input type="checkbox"/> Top Mount | EFFECT: (CHECK ONE) | <input type="checkbox"/> Comp/Echo | <input type="checkbox"/> Touch Wah |
| | <input type="checkbox"/> Acoustic | <input type="checkbox"/> High Power | | <input type="checkbox"/> Comp/Chorus | <input type="checkbox"/> Compressor |
| | <input type="checkbox"/> Blue Voodoo | <input type="checkbox"/> Studio Tweed | | <input type="checkbox"/> Cmp/Fly/Echo | <input type="checkbox"/> Tremolo |
| | <input type="checkbox"/> Vintage Club | <input type="checkbox"/> Black Face | | <input type="checkbox"/> Cmp/Cho/Echo | <input type="checkbox"/> Vibrato |
| | <input type="checkbox"/> Flexwave | <input type="checkbox"/> Large Tweed | | <input type="checkbox"/> Cmp/Vib/Echo | <input type="checkbox"/> Chorus |
| | <input type="checkbox"/> Ampeg VL | <input type="checkbox"/> 60s Era UK | | <input type="checkbox"/> Flange/Echo | <input type="checkbox"/> Flanger |
| | <input type="checkbox"/> Calif Mod | <input type="checkbox"/> 70s Era UK | | <input type="checkbox"/> Chor/Echo | <input type="checkbox"/> Delay |
| | <input type="checkbox"/> Tube Rectifier | <input type="checkbox"/> Fuzzbox | | <input type="checkbox"/> Rotating Spkr | <input type="checkbox"/> Echo |

| | | | | | | | |
|------|------|-----|--------|---------------|---------------|--------------|--------------|
| | | | | | | | |
| GAIN | BASS | MID | TREBLE | CHANNEL LEVEL | EFFECT ADJUST | REVERB LEVEL | REVERB DEPTH |

Preset # 35 *I think I'll call it:* _____ Set TAP for _____ beats/minute

| | | | | | |
|---------------------------|---|---------------------------------------|------------------------|--|-------------------------------------|
| AMP MODEL: (CHECK ONE) | <input type="checkbox"/> Clean | <input type="checkbox"/> Top Mount | EFFECT: (CHECK ONE) | <input type="checkbox"/> Comp/Echo | <input type="checkbox"/> Touch Wah |
| | <input type="checkbox"/> Acoustic | <input type="checkbox"/> High Power | | <input type="checkbox"/> Comp/Chorus | <input type="checkbox"/> Compressor |
| | <input type="checkbox"/> Blue Voodoo | <input type="checkbox"/> Studio Tweed | | <input type="checkbox"/> Cmp/Fly/Echo | <input type="checkbox"/> Tremolo |
| | <input type="checkbox"/> Vintage Club | <input type="checkbox"/> Black Face | | <input type="checkbox"/> Cmp/Cho/Echo | <input type="checkbox"/> Vibrato |
| | <input type="checkbox"/> Flexwave | <input type="checkbox"/> Large Tweed | | <input type="checkbox"/> Cmp/Vib/Echo | <input type="checkbox"/> Chorus |
| | <input type="checkbox"/> Ampeg VL | <input type="checkbox"/> 60s Era UK | | <input type="checkbox"/> Flange/Echo | <input type="checkbox"/> Flanger |
| | <input type="checkbox"/> Calif Mod | <input type="checkbox"/> 70s Era UK | | <input type="checkbox"/> Chor/Echo | <input type="checkbox"/> Delay |
| | <input type="checkbox"/> Tube Rectifier | <input type="checkbox"/> Fuzzbox | | <input type="checkbox"/> Rotating Spkr | <input type="checkbox"/> Echo |

| | | | | | | | |
|------|------|-----|--------|---------------|---------------|--------------|--------------|
| | | | | | | | |
| GAIN | BASS | MID | TREBLE | CHANNEL LEVEL | EFFECT ADJUST | REVERB LEVEL | REVERB DEPTH |

FAVORITES

DX-112/212 Digital Guitar Amplifier **CRATE**

USER PRESETS 36–40 - BANK B

Preset # 36 *I think I'll call it:* _____ Set TAP for _____ beats/minute

| | | | | | | | | | | | | | | | | | | | |
|---|--|-------------------------------------|---|------------------------------------|------------------------------------|--------------------------------------|-------------------------------------|--|----------------------------------|--|----------------------------------|--|---------------------------------|--------------------------------------|----------------------------------|------------------------------------|--------------------------------|--|-------------------------------|
| AMP MODEL: (CHECK ONE) | <input type="checkbox"/> Clean | <input type="checkbox"/> Top Mount | EFFECT: (CHECK ONE) <table border="1"> <tr><td><input type="checkbox"/> Comp/Echo</td><td><input type="checkbox"/> Touch Wah</td></tr> <tr><td><input type="checkbox"/> Comp/Chorus</td><td><input type="checkbox"/> Compressor</td></tr> <tr><td><input type="checkbox"/> Comp/Flg/Echo</td><td><input type="checkbox"/> Tremolo</td></tr> <tr><td><input type="checkbox"/> Comp/Cho/Echo</td><td><input type="checkbox"/> Vibrato</td></tr> <tr><td><input type="checkbox"/> Comp/Vib/Echo</td><td><input type="checkbox"/> Chorus</td></tr> <tr><td><input type="checkbox"/> Flange/Echo</td><td><input type="checkbox"/> Flanger</td></tr> <tr><td><input type="checkbox"/> Chor/Echo</td><td><input type="checkbox"/> Delay</td></tr> <tr><td><input type="checkbox"/> Rotating Spkr</td><td><input type="checkbox"/> Echo</td></tr> </table> | <input type="checkbox"/> Comp/Echo | <input type="checkbox"/> Touch Wah | <input type="checkbox"/> Comp/Chorus | <input type="checkbox"/> Compressor | <input type="checkbox"/> Comp/Flg/Echo | <input type="checkbox"/> Tremolo | <input type="checkbox"/> Comp/Cho/Echo | <input type="checkbox"/> Vibrato | <input type="checkbox"/> Comp/Vib/Echo | <input type="checkbox"/> Chorus | <input type="checkbox"/> Flange/Echo | <input type="checkbox"/> Flanger | <input type="checkbox"/> Chor/Echo | <input type="checkbox"/> Delay | <input type="checkbox"/> Rotating Spkr | <input type="checkbox"/> Echo |
| | <input type="checkbox"/> Comp/Echo | <input type="checkbox"/> Touch Wah | | | | | | | | | | | | | | | | | |
| | <input type="checkbox"/> Comp/Chorus | <input type="checkbox"/> Compressor | | | | | | | | | | | | | | | | | |
| | <input type="checkbox"/> Comp/Flg/Echo | <input type="checkbox"/> Tremolo | | | | | | | | | | | | | | | | | |
| | <input type="checkbox"/> Comp/Cho/Echo | <input type="checkbox"/> Vibrato | | | | | | | | | | | | | | | | | |
| | <input type="checkbox"/> Comp/Vib/Echo | <input type="checkbox"/> Chorus | | | | | | | | | | | | | | | | | |
| | <input type="checkbox"/> Flange/Echo | <input type="checkbox"/> Flanger | | | | | | | | | | | | | | | | | |
| <input type="checkbox"/> Chor/Echo | <input type="checkbox"/> Delay | | | | | | | | | | | | | | | | | | |
| <input type="checkbox"/> Rotating Spkr | <input type="checkbox"/> Echo | | | | | | | | | | | | | | | | | | |
| <input type="checkbox"/> Acoustic | <input type="checkbox"/> High Power | | | | | | | | | | | | | | | | | | |
| <input type="checkbox"/> Blue Voodoo | <input type="checkbox"/> Studio Tweed | | | | | | | | | | | | | | | | | | |
| <input type="checkbox"/> Vintage Club | <input type="checkbox"/> Black Face | | | | | | | | | | | | | | | | | | |
| <input type="checkbox"/> Flexwave | <input type="checkbox"/> Large Tweed | | | | | | | | | | | | | | | | | | |
| <input type="checkbox"/> Ampeg VL | <input type="checkbox"/> 60s Era UK | | | | | | | | | | | | | | | | | | |
| <input type="checkbox"/> Calif Mod | <input type="checkbox"/> 70s Era UK | | | | | | | | | | | | | | | | | | |
| <input type="checkbox"/> Tube Rectifier | <input type="checkbox"/> Fuzzbox | | | | | | | | | | | | | | | | | | |

| | | | | | | | |
|------|------|-----|--------|---------------|---------------|--------------|--------------|
| | | | | | | | |
| GAIN | BASS | MID | TREBLE | CHANNEL LEVEL | EFFECT ADJUST | REVERB LEVEL | REVERB DEPTH |

Preset # 37 *I think I'll call it:* _____ Set TAP for _____ beats/minute

| | | | | | | | | | | | | | | | | | | | |
|---|--|-------------------------------------|---|------------------------------------|------------------------------------|--------------------------------------|-------------------------------------|--|----------------------------------|--|----------------------------------|--|---------------------------------|--------------------------------------|----------------------------------|------------------------------------|--------------------------------|--|-------------------------------|
| AMP MODEL: (CHECK ONE) | <input type="checkbox"/> Clean | <input type="checkbox"/> Top Mount | EFFECT: (CHECK ONE) <table border="1"> <tr><td><input type="checkbox"/> Comp/Echo</td><td><input type="checkbox"/> Touch Wah</td></tr> <tr><td><input type="checkbox"/> Comp/Chorus</td><td><input type="checkbox"/> Compressor</td></tr> <tr><td><input type="checkbox"/> Comp/Flg/Echo</td><td><input type="checkbox"/> Tremolo</td></tr> <tr><td><input type="checkbox"/> Comp/Cho/Echo</td><td><input type="checkbox"/> Vibrato</td></tr> <tr><td><input type="checkbox"/> Comp/Vib/Echo</td><td><input type="checkbox"/> Chorus</td></tr> <tr><td><input type="checkbox"/> Flange/Echo</td><td><input type="checkbox"/> Flanger</td></tr> <tr><td><input type="checkbox"/> Chor/Echo</td><td><input type="checkbox"/> Delay</td></tr> <tr><td><input type="checkbox"/> Rotating Spkr</td><td><input type="checkbox"/> Echo</td></tr> </table> | <input type="checkbox"/> Comp/Echo | <input type="checkbox"/> Touch Wah | <input type="checkbox"/> Comp/Chorus | <input type="checkbox"/> Compressor | <input type="checkbox"/> Comp/Flg/Echo | <input type="checkbox"/> Tremolo | <input type="checkbox"/> Comp/Cho/Echo | <input type="checkbox"/> Vibrato | <input type="checkbox"/> Comp/Vib/Echo | <input type="checkbox"/> Chorus | <input type="checkbox"/> Flange/Echo | <input type="checkbox"/> Flanger | <input type="checkbox"/> Chor/Echo | <input type="checkbox"/> Delay | <input type="checkbox"/> Rotating Spkr | <input type="checkbox"/> Echo |
| | <input type="checkbox"/> Comp/Echo | <input type="checkbox"/> Touch Wah | | | | | | | | | | | | | | | | | |
| | <input type="checkbox"/> Comp/Chorus | <input type="checkbox"/> Compressor | | | | | | | | | | | | | | | | | |
| | <input type="checkbox"/> Comp/Flg/Echo | <input type="checkbox"/> Tremolo | | | | | | | | | | | | | | | | | |
| | <input type="checkbox"/> Comp/Cho/Echo | <input type="checkbox"/> Vibrato | | | | | | | | | | | | | | | | | |
| | <input type="checkbox"/> Comp/Vib/Echo | <input type="checkbox"/> Chorus | | | | | | | | | | | | | | | | | |
| | <input type="checkbox"/> Flange/Echo | <input type="checkbox"/> Flanger | | | | | | | | | | | | | | | | | |
| <input type="checkbox"/> Chor/Echo | <input type="checkbox"/> Delay | | | | | | | | | | | | | | | | | | |
| <input type="checkbox"/> Rotating Spkr | <input type="checkbox"/> Echo | | | | | | | | | | | | | | | | | | |
| <input type="checkbox"/> Acoustic | <input type="checkbox"/> High Power | | | | | | | | | | | | | | | | | | |
| <input type="checkbox"/> Blue Voodoo | <input type="checkbox"/> Studio Tweed | | | | | | | | | | | | | | | | | | |
| <input type="checkbox"/> Vintage Club | <input type="checkbox"/> Black Face | | | | | | | | | | | | | | | | | | |
| <input type="checkbox"/> Flexwave | <input type="checkbox"/> Large Tweed | | | | | | | | | | | | | | | | | | |
| <input type="checkbox"/> Ampeg VL | <input type="checkbox"/> 60s Era UK | | | | | | | | | | | | | | | | | | |
| <input type="checkbox"/> Calif Mod | <input type="checkbox"/> 70s Era UK | | | | | | | | | | | | | | | | | | |
| <input type="checkbox"/> Tube Rectifier | <input type="checkbox"/> Fuzzbox | | | | | | | | | | | | | | | | | | |

| | | | | | | | |
|------|------|-----|--------|---------------|---------------|--------------|--------------|
| | | | | | | | |
| GAIN | BASS | MID | TREBLE | CHANNEL LEVEL | EFFECT ADJUST | REVERB LEVEL | REVERB DEPTH |

Preset # 38 *I think I'll call it:* _____ Set TAP for _____ beats/minute

| | | | | | | | | | | | | | | | | | | | |
|---|--|-------------------------------------|---|------------------------------------|------------------------------------|--------------------------------------|-------------------------------------|--|----------------------------------|--|----------------------------------|--|---------------------------------|--------------------------------------|----------------------------------|------------------------------------|--------------------------------|--|-------------------------------|
| AMP MODEL: (CHECK ONE) | <input type="checkbox"/> Clean | <input type="checkbox"/> Top Mount | EFFECT: (CHECK ONE) <table border="1"> <tr><td><input type="checkbox"/> Comp/Echo</td><td><input type="checkbox"/> Touch Wah</td></tr> <tr><td><input type="checkbox"/> Comp/Chorus</td><td><input type="checkbox"/> Compressor</td></tr> <tr><td><input type="checkbox"/> Comp/Flg/Echo</td><td><input type="checkbox"/> Tremolo</td></tr> <tr><td><input type="checkbox"/> Comp/Cho/Echo</td><td><input type="checkbox"/> Vibrato</td></tr> <tr><td><input type="checkbox"/> Comp/Vib/Echo</td><td><input type="checkbox"/> Chorus</td></tr> <tr><td><input type="checkbox"/> Flange/Echo</td><td><input type="checkbox"/> Flanger</td></tr> <tr><td><input type="checkbox"/> Chor/Echo</td><td><input type="checkbox"/> Delay</td></tr> <tr><td><input type="checkbox"/> Rotating Spkr</td><td><input type="checkbox"/> Echo</td></tr> </table> | <input type="checkbox"/> Comp/Echo | <input type="checkbox"/> Touch Wah | <input type="checkbox"/> Comp/Chorus | <input type="checkbox"/> Compressor | <input type="checkbox"/> Comp/Flg/Echo | <input type="checkbox"/> Tremolo | <input type="checkbox"/> Comp/Cho/Echo | <input type="checkbox"/> Vibrato | <input type="checkbox"/> Comp/Vib/Echo | <input type="checkbox"/> Chorus | <input type="checkbox"/> Flange/Echo | <input type="checkbox"/> Flanger | <input type="checkbox"/> Chor/Echo | <input type="checkbox"/> Delay | <input type="checkbox"/> Rotating Spkr | <input type="checkbox"/> Echo |
| | <input type="checkbox"/> Comp/Echo | <input type="checkbox"/> Touch Wah | | | | | | | | | | | | | | | | | |
| | <input type="checkbox"/> Comp/Chorus | <input type="checkbox"/> Compressor | | | | | | | | | | | | | | | | | |
| | <input type="checkbox"/> Comp/Flg/Echo | <input type="checkbox"/> Tremolo | | | | | | | | | | | | | | | | | |
| | <input type="checkbox"/> Comp/Cho/Echo | <input type="checkbox"/> Vibrato | | | | | | | | | | | | | | | | | |
| | <input type="checkbox"/> Comp/Vib/Echo | <input type="checkbox"/> Chorus | | | | | | | | | | | | | | | | | |
| | <input type="checkbox"/> Flange/Echo | <input type="checkbox"/> Flanger | | | | | | | | | | | | | | | | | |
| <input type="checkbox"/> Chor/Echo | <input type="checkbox"/> Delay | | | | | | | | | | | | | | | | | | |
| <input type="checkbox"/> Rotating Spkr | <input type="checkbox"/> Echo | | | | | | | | | | | | | | | | | | |
| <input type="checkbox"/> Acoustic | <input type="checkbox"/> High Power | | | | | | | | | | | | | | | | | | |
| <input type="checkbox"/> Blue Voodoo | <input type="checkbox"/> Studio Tweed | | | | | | | | | | | | | | | | | | |
| <input type="checkbox"/> Vintage Club | <input type="checkbox"/> Black Face | | | | | | | | | | | | | | | | | | |
| <input type="checkbox"/> Flexwave | <input type="checkbox"/> Large Tweed | | | | | | | | | | | | | | | | | | |
| <input type="checkbox"/> Ampeg VL | <input type="checkbox"/> 60s Era UK | | | | | | | | | | | | | | | | | | |
| <input type="checkbox"/> Calif Mod | <input type="checkbox"/> 70s Era UK | | | | | | | | | | | | | | | | | | |
| <input type="checkbox"/> Tube Rectifier | <input type="checkbox"/> Fuzzbox | | | | | | | | | | | | | | | | | | |

| | | | | | | | |
|------|------|-----|--------|---------------|---------------|--------------|--------------|
| | | | | | | | |
| GAIN | BASS | MID | TREBLE | CHANNEL LEVEL | EFFECT ADJUST | REVERB LEVEL | REVERB DEPTH |

Preset # 39 *I think I'll call it:* _____ Set TAP for _____ beats/minute

| | | | | | | | | | | | | | | | | | | | |
|---|--|-------------------------------------|---|------------------------------------|------------------------------------|--------------------------------------|-------------------------------------|--|----------------------------------|--|----------------------------------|--|---------------------------------|--------------------------------------|----------------------------------|------------------------------------|--------------------------------|--|-------------------------------|
| AMP MODEL: (CHECK ONE) | <input type="checkbox"/> Clean | <input type="checkbox"/> Top Mount | EFFECT: (CHECK ONE) <table border="1"> <tr><td><input type="checkbox"/> Comp/Echo</td><td><input type="checkbox"/> Touch Wah</td></tr> <tr><td><input type="checkbox"/> Comp/Chorus</td><td><input type="checkbox"/> Compressor</td></tr> <tr><td><input type="checkbox"/> Comp/Flg/Echo</td><td><input type="checkbox"/> Tremolo</td></tr> <tr><td><input type="checkbox"/> Comp/Cho/Echo</td><td><input type="checkbox"/> Vibrato</td></tr> <tr><td><input type="checkbox"/> Comp/Vib/Echo</td><td><input type="checkbox"/> Chorus</td></tr> <tr><td><input type="checkbox"/> Flange/Echo</td><td><input type="checkbox"/> Flanger</td></tr> <tr><td><input type="checkbox"/> Chor/Echo</td><td><input type="checkbox"/> Delay</td></tr> <tr><td><input type="checkbox"/> Rotating Spkr</td><td><input type="checkbox"/> Echo</td></tr> </table> | <input type="checkbox"/> Comp/Echo | <input type="checkbox"/> Touch Wah | <input type="checkbox"/> Comp/Chorus | <input type="checkbox"/> Compressor | <input type="checkbox"/> Comp/Flg/Echo | <input type="checkbox"/> Tremolo | <input type="checkbox"/> Comp/Cho/Echo | <input type="checkbox"/> Vibrato | <input type="checkbox"/> Comp/Vib/Echo | <input type="checkbox"/> Chorus | <input type="checkbox"/> Flange/Echo | <input type="checkbox"/> Flanger | <input type="checkbox"/> Chor/Echo | <input type="checkbox"/> Delay | <input type="checkbox"/> Rotating Spkr | <input type="checkbox"/> Echo |
| | <input type="checkbox"/> Comp/Echo | <input type="checkbox"/> Touch Wah | | | | | | | | | | | | | | | | | |
| | <input type="checkbox"/> Comp/Chorus | <input type="checkbox"/> Compressor | | | | | | | | | | | | | | | | | |
| | <input type="checkbox"/> Comp/Flg/Echo | <input type="checkbox"/> Tremolo | | | | | | | | | | | | | | | | | |
| | <input type="checkbox"/> Comp/Cho/Echo | <input type="checkbox"/> Vibrato | | | | | | | | | | | | | | | | | |
| | <input type="checkbox"/> Comp/Vib/Echo | <input type="checkbox"/> Chorus | | | | | | | | | | | | | | | | | |
| | <input type="checkbox"/> Flange/Echo | <input type="checkbox"/> Flanger | | | | | | | | | | | | | | | | | |
| <input type="checkbox"/> Chor/Echo | <input type="checkbox"/> Delay | | | | | | | | | | | | | | | | | | |
| <input type="checkbox"/> Rotating Spkr | <input type="checkbox"/> Echo | | | | | | | | | | | | | | | | | | |
| <input type="checkbox"/> Acoustic | <input type="checkbox"/> High Power | | | | | | | | | | | | | | | | | | |
| <input type="checkbox"/> Blue Voodoo | <input type="checkbox"/> Studio Tweed | | | | | | | | | | | | | | | | | | |
| <input type="checkbox"/> Vintage Club | <input type="checkbox"/> Black Face | | | | | | | | | | | | | | | | | | |
| <input type="checkbox"/> Flexwave | <input type="checkbox"/> Large Tweed | | | | | | | | | | | | | | | | | | |
| <input type="checkbox"/> Ampeg VL | <input type="checkbox"/> 60s Era UK | | | | | | | | | | | | | | | | | | |
| <input type="checkbox"/> Calif Mod | <input type="checkbox"/> 70s Era UK | | | | | | | | | | | | | | | | | | |
| <input type="checkbox"/> Tube Rectifier | <input type="checkbox"/> Fuzzbox | | | | | | | | | | | | | | | | | | |

| | | | | | | | |
|------|------|-----|--------|---------------|---------------|--------------|--------------|
| | | | | | | | |
| GAIN | BASS | MID | TREBLE | CHANNEL LEVEL | EFFECT ADJUST | REVERB LEVEL | REVERB DEPTH |

Preset # 40 *I think I'll call it:* _____ Set TAP for _____ beats/minute

| | | | | | | | | | | | | | | | | | | | |
|---|--|-------------------------------------|---|------------------------------------|------------------------------------|--------------------------------------|-------------------------------------|--|----------------------------------|--|----------------------------------|--|---------------------------------|--------------------------------------|----------------------------------|------------------------------------|--------------------------------|--|-------------------------------|
| AMP MODEL: (CHECK ONE) | <input type="checkbox"/> Clean | <input type="checkbox"/> Top Mount | EFFECT: (CHECK ONE) <table border="1"> <tr><td><input type="checkbox"/> Comp/Echo</td><td><input type="checkbox"/> Touch Wah</td></tr> <tr><td><input type="checkbox"/> Comp/Chorus</td><td><input type="checkbox"/> Compressor</td></tr> <tr><td><input type="checkbox"/> Comp/Flg/Echo</td><td><input type="checkbox"/> Tremolo</td></tr> <tr><td><input type="checkbox"/> Comp/Cho/Echo</td><td><input type="checkbox"/> Vibrato</td></tr> <tr><td><input type="checkbox"/> Comp/Vib/Echo</td><td><input type="checkbox"/> Chorus</td></tr> <tr><td><input type="checkbox"/> Flange/Echo</td><td><input type="checkbox"/> Flanger</td></tr> <tr><td><input type="checkbox"/> Chor/Echo</td><td><input type="checkbox"/> Delay</td></tr> <tr><td><input type="checkbox"/> Rotating Spkr</td><td><input type="checkbox"/> Echo</td></tr> </table> | <input type="checkbox"/> Comp/Echo | <input type="checkbox"/> Touch Wah | <input type="checkbox"/> Comp/Chorus | <input type="checkbox"/> Compressor | <input type="checkbox"/> Comp/Flg/Echo | <input type="checkbox"/> Tremolo | <input type="checkbox"/> Comp/Cho/Echo | <input type="checkbox"/> Vibrato | <input type="checkbox"/> Comp/Vib/Echo | <input type="checkbox"/> Chorus | <input type="checkbox"/> Flange/Echo | <input type="checkbox"/> Flanger | <input type="checkbox"/> Chor/Echo | <input type="checkbox"/> Delay | <input type="checkbox"/> Rotating Spkr | <input type="checkbox"/> Echo |
| | <input type="checkbox"/> Comp/Echo | <input type="checkbox"/> Touch Wah | | | | | | | | | | | | | | | | | |
| | <input type="checkbox"/> Comp/Chorus | <input type="checkbox"/> Compressor | | | | | | | | | | | | | | | | | |
| | <input type="checkbox"/> Comp/Flg/Echo | <input type="checkbox"/> Tremolo | | | | | | | | | | | | | | | | | |
| | <input type="checkbox"/> Comp/Cho/Echo | <input type="checkbox"/> Vibrato | | | | | | | | | | | | | | | | | |
| | <input type="checkbox"/> Comp/Vib/Echo | <input type="checkbox"/> Chorus | | | | | | | | | | | | | | | | | |
| | <input type="checkbox"/> Flange/Echo | <input type="checkbox"/> Flanger | | | | | | | | | | | | | | | | | |
| <input type="checkbox"/> Chor/Echo | <input type="checkbox"/> Delay | | | | | | | | | | | | | | | | | | |
| <input type="checkbox"/> Rotating Spkr | <input type="checkbox"/> Echo | | | | | | | | | | | | | | | | | | |
| <input type="checkbox"/> Acoustic | <input type="checkbox"/> High Power | | | | | | | | | | | | | | | | | | |
| <input type="checkbox"/> Blue Voodoo | <input type="checkbox"/> Studio Tweed | | | | | | | | | | | | | | | | | | |
| <input type="checkbox"/> Vintage Club | <input type="checkbox"/> Black Face | | | | | | | | | | | | | | | | | | |
| <input type="checkbox"/> Flexwave | <input type="checkbox"/> Large Tweed | | | | | | | | | | | | | | | | | | |
| <input type="checkbox"/> Ampeg VL | <input type="checkbox"/> 60s Era UK | | | | | | | | | | | | | | | | | | |
| <input type="checkbox"/> Calif Mod | <input type="checkbox"/> 70s Era UK | | | | | | | | | | | | | | | | | | |
| <input type="checkbox"/> Tube Rectifier | <input type="checkbox"/> Fuzzbox | | | | | | | | | | | | | | | | | | |

| | | | | | | | |
|------|------|-----|--------|---------------|---------------|--------------|--------------|
| | | | | | | | |
| GAIN | BASS | MID | TREBLE | CHANNEL LEVEL | EFFECT ADJUST | REVERB LEVEL | REVERB DEPTH |

FAVORITES

CRATE DX-112/212 Digital Guitar Amplifier

USER PRESETS 41–45 - BANK A

Preset # 41 *I think I'll call it:* _____ Set TAP for _____ beats/minute

| | | | | | | | | | |
|----------------------------------|---|---------------------------------------|-------------------------------|--|--|--|--|--|-------------------------------------|
| AMP MODEL: (CHECK ONE) | <input type="checkbox"/> Clean | <input type="checkbox"/> Top Mount | EFFECT: (CHECK ONE) | | | | | <input type="checkbox"/> Comp/Echo | <input type="checkbox"/> Touch Wah |
| | <input type="checkbox"/> Acoustic | <input type="checkbox"/> High Power | | | | | | <input type="checkbox"/> Comp/Chorus | <input type="checkbox"/> Compressor |
| | <input type="checkbox"/> Blue Voodoo | <input type="checkbox"/> Studio Tweed | | | | | | <input type="checkbox"/> Cmp/Fly/Echo | <input type="checkbox"/> Tremolo |
| | <input type="checkbox"/> Vintage Club | <input type="checkbox"/> Black Face | | | | | | <input type="checkbox"/> Cmp/Cho/Echo | <input type="checkbox"/> Vibrato |
| | <input type="checkbox"/> Flexwave | <input type="checkbox"/> Large Tweed | | | | | | <input type="checkbox"/> Cmp/Vib/Echo | <input type="checkbox"/> Chorus |
| | <input type="checkbox"/> Ampeg VL | <input type="checkbox"/> 60s Era UK | | | | | | <input type="checkbox"/> Flange/Echo | <input type="checkbox"/> Flanger |
| | <input type="checkbox"/> Calif Mod | <input type="checkbox"/> 70s Era UK | | | | | | <input type="checkbox"/> Chor/Echo | <input type="checkbox"/> Delay |
| | <input type="checkbox"/> Tube Rectifier | <input type="checkbox"/> Fuzzbox | | | | | | <input type="checkbox"/> Rotating Spkr | <input type="checkbox"/> Echo |



GAIN



BASS



MID



TREBLE



CHANNEL LEVEL



EFFECT ADJUST



REVERB LEVEL



REVERB DEPTH

Preset # 42 *I think I'll call it:* _____ Set TAP for _____ beats/minute

| | | | | | | | | | |
|----------------------------------|---|---------------------------------------|-------------------------------|--|--|--|--|--|-------------------------------------|
| AMP MODEL: (CHECK ONE) | <input type="checkbox"/> Clean | <input type="checkbox"/> Top Mount | EFFECT: (CHECK ONE) | | | | | <input type="checkbox"/> Comp/Echo | <input type="checkbox"/> Touch Wah |
| | <input type="checkbox"/> Acoustic | <input type="checkbox"/> High Power | | | | | | <input type="checkbox"/> Comp/Chorus | <input type="checkbox"/> Compressor |
| | <input type="checkbox"/> Blue Voodoo | <input type="checkbox"/> Studio Tweed | | | | | | <input type="checkbox"/> Cmp/Fly/Echo | <input type="checkbox"/> Tremolo |
| | <input type="checkbox"/> Vintage Club | <input type="checkbox"/> Black Face | | | | | | <input type="checkbox"/> Cmp/Cho/Echo | <input type="checkbox"/> Vibrato |
| | <input type="checkbox"/> Flexwave | <input type="checkbox"/> Large Tweed | | | | | | <input type="checkbox"/> Cmp/Vib/Echo | <input type="checkbox"/> Chorus |
| | <input type="checkbox"/> Ampeg VL | <input type="checkbox"/> 60s Era UK | | | | | | <input type="checkbox"/> Flange/Echo | <input type="checkbox"/> Flanger |
| | <input type="checkbox"/> Calif Mod | <input type="checkbox"/> 70s Era UK | | | | | | <input type="checkbox"/> Chor/Echo | <input type="checkbox"/> Delay |
| | <input type="checkbox"/> Tube Rectifier | <input type="checkbox"/> Fuzzbox | | | | | | <input type="checkbox"/> Rotating Spkr | <input type="checkbox"/> Echo |



GAIN



BASS



MID



TREBLE



CHANNEL LEVEL



EFFECT ADJUST



REVERB LEVEL



REVERB DEPTH

Preset # 43 *I think I'll call it:* _____ Set TAP for _____ beats/minute

| | | | | | | | | | |
|----------------------------------|---|---------------------------------------|-------------------------------|--|--|--|--|--|-------------------------------------|
| AMP MODEL: (CHECK ONE) | <input type="checkbox"/> Clean | <input type="checkbox"/> Top Mount | EFFECT: (CHECK ONE) | | | | | <input type="checkbox"/> Comp/Echo | <input type="checkbox"/> Touch Wah |
| | <input type="checkbox"/> Acoustic | <input type="checkbox"/> High Power | | | | | | <input type="checkbox"/> Comp/Chorus | <input type="checkbox"/> Compressor |
| | <input type="checkbox"/> Blue Voodoo | <input type="checkbox"/> Studio Tweed | | | | | | <input type="checkbox"/> Cmp/Fly/Echo | <input type="checkbox"/> Tremolo |
| | <input type="checkbox"/> Vintage Club | <input type="checkbox"/> Black Face | | | | | | <input type="checkbox"/> Cmp/Cho/Echo | <input type="checkbox"/> Vibrato |
| | <input type="checkbox"/> Flexwave | <input type="checkbox"/> Large Tweed | | | | | | <input type="checkbox"/> Cmp/Vib/Echo | <input type="checkbox"/> Chorus |
| | <input type="checkbox"/> Ampeg VL | <input type="checkbox"/> 60s Era UK | | | | | | <input type="checkbox"/> Flange/Echo | <input type="checkbox"/> Flanger |
| | <input type="checkbox"/> Calif Mod | <input type="checkbox"/> 70s Era UK | | | | | | <input type="checkbox"/> Chor/Echo | <input type="checkbox"/> Delay |
| | <input type="checkbox"/> Tube Rectifier | <input type="checkbox"/> Fuzzbox | | | | | | <input type="checkbox"/> Rotating Spkr | <input type="checkbox"/> Echo |



GAIN



BASS



MID



TREBLE



CHANNEL LEVEL



EFFECT ADJUST



REVERB LEVEL



REVERB DEPTH

Preset # 44 *I think I'll call it:* _____ Set TAP for _____ beats/minute

| | | | | | | | | | |
|----------------------------------|---|---------------------------------------|-------------------------------|--|--|--|--|--|-------------------------------------|
| AMP MODEL: (CHECK ONE) | <input type="checkbox"/> Clean | <input type="checkbox"/> Top Mount | EFFECT: (CHECK ONE) | | | | | <input type="checkbox"/> Comp/Echo | <input type="checkbox"/> Touch Wah |
| | <input type="checkbox"/> Acoustic | <input type="checkbox"/> High Power | | | | | | <input type="checkbox"/> Comp/Chorus | <input type="checkbox"/> Compressor |
| | <input type="checkbox"/> Blue Voodoo | <input type="checkbox"/> Studio Tweed | | | | | | <input type="checkbox"/> Cmp/Fly/Echo | <input type="checkbox"/> Tremolo |
| | <input type="checkbox"/> Vintage Club | <input type="checkbox"/> Black Face | | | | | | <input type="checkbox"/> Cmp/Cho/Echo | <input type="checkbox"/> Vibrato |
| | <input type="checkbox"/> Flexwave | <input type="checkbox"/> Large Tweed | | | | | | <input type="checkbox"/> Cmp/Vib/Echo | <input type="checkbox"/> Chorus |
| | <input type="checkbox"/> Ampeg VL | <input type="checkbox"/> 60s Era UK | | | | | | <input type="checkbox"/> Flange/Echo | <input type="checkbox"/> Flanger |
| | <input type="checkbox"/> Calif Mod | <input type="checkbox"/> 70s Era UK | | | | | | <input type="checkbox"/> Chor/Echo | <input type="checkbox"/> Delay |
| | <input type="checkbox"/> Tube Rectifier | <input type="checkbox"/> Fuzzbox | | | | | | <input type="checkbox"/> Rotating Spkr | <input type="checkbox"/> Echo |



GAIN



BASS



MID



TREBLE



CHANNEL LEVEL



EFFECT ADJUST



REVERB LEVEL



REVERB DEPTH

Preset # 45 *I think I'll call it:* _____ Set TAP for _____ beats/minute

| | | | | | | | | | |
|----------------------------------|---|---------------------------------------|-------------------------------|--|--|--|--|--|-------------------------------------|
| AMP MODEL: (CHECK ONE) | <input type="checkbox"/> Clean | <input type="checkbox"/> Top Mount | EFFECT: (CHECK ONE) | | | | | <input type="checkbox"/> Comp/Echo | <input type="checkbox"/> Touch Wah |
| | <input type="checkbox"/> Acoustic | <input type="checkbox"/> High Power | | | | | | <input type="checkbox"/> Comp/Chorus | <input type="checkbox"/> Compressor |
| | <input type="checkbox"/> Blue Voodoo | <input type="checkbox"/> Studio Tweed | | | | | | <input type="checkbox"/> Cmp/Fly/Echo | <input type="checkbox"/> Tremolo |
| | <input type="checkbox"/> Vintage Club | <input type="checkbox"/> Black Face | | | | | | <input type="checkbox"/> Cmp/Cho/Echo | <input type="checkbox"/> Vibrato |
| | <input type="checkbox"/> Flexwave | <input type="checkbox"/> Large Tweed | | | | | | <input type="checkbox"/> Cmp/Vib/Echo | <input type="checkbox"/> Chorus |
| | <input type="checkbox"/> Ampeg VL | <input type="checkbox"/> 60s Era UK | | | | | | <input type="checkbox"/> Flange/Echo | <input type="checkbox"/> Flanger |
| | <input type="checkbox"/> Calif Mod | <input type="checkbox"/> 70s Era UK | | | | | | <input type="checkbox"/> Chor/Echo | <input type="checkbox"/> Delay |
| | <input type="checkbox"/> Tube Rectifier | <input type="checkbox"/> Fuzzbox | | | | | | <input type="checkbox"/> Rotating Spkr | <input type="checkbox"/> Echo |



GAIN



BASS



MID



TREBLE



CHANNEL LEVEL



EFFECT ADJUST



REVERB LEVEL











REVERB DEPTH

DX-112/212 Digital Guitar Amplifier **CRATE**



USER PRESETS 46–50 - BANK B





Preset # 46 *I think I'll call it:* _____ Set TAP for _____ beats/minute

| | | | | | | | | |
|---|---------------------------------------|--|--------------------------------|---------------------------------------|-------------------------------------|--|---|---|
| AMP MODEL: (CHECK ONE) | <input type="checkbox"/> Clean | <input type="checkbox"/> Top Mount | EFFECT: (CHECK ONE) | <input type="checkbox"/> Comp/Echo | <input type="checkbox"/> Touch Wah |  EFFECT ADJUST |  REVERB LEVEL |  REVERB DEPTH |
| | <input type="checkbox"/> Acoustic | <input type="checkbox"/> High Power | | <input type="checkbox"/> Comp/Chorus | <input type="checkbox"/> Compressor | | | |
| | <input type="checkbox"/> Blue Voodoo | <input type="checkbox"/> Studio Tweed | | <input type="checkbox"/> Cmp/Flg/Echo | <input type="checkbox"/> Tremolo | | | |
| | <input type="checkbox"/> Vintage Club | <input type="checkbox"/> Black Face | | <input type="checkbox"/> Cmp/Cho/Echo | <input type="checkbox"/> Vibrato | | | |
| | <input type="checkbox"/> Flexwave | <input type="checkbox"/> Large Tweed | | <input type="checkbox"/> Cmp/Vib/Echo | <input type="checkbox"/> Chorus | | | |
| | <input type="checkbox"/> Ampeg VL | <input type="checkbox"/> 60s Era UK | | <input type="checkbox"/> Flange/Echo | <input type="checkbox"/> Flanger | | | |
| <input type="checkbox"/> Calif Mod | <input type="checkbox"/> 70s Era UK | <input type="checkbox"/> Chor/Echo | <input type="checkbox"/> Delay | | | | | |
| <input type="checkbox"/> Tube Rectifier | <input type="checkbox"/> Fuzzbox | <input type="checkbox"/> Rotating Spkr | <input type="checkbox"/> Echo | | | | | |



| | | | | |
|---|---|---|---|---|
|  |  |  |  |  |
| GAIN | BASS | MID | TREBLE | CHANNEL LEVEL |





Preset # 47 *I think I'll call it:* _____ Set TAP for _____ beats/minute

| | | | | | | | | |
|---|---------------------------------------|--|--------------------------------|---------------------------------------|-------------------------------------|--|---|---|
| AMP MODEL: (CHECK ONE) | <input type="checkbox"/> Clean | <input type="checkbox"/> Top Mount | EFFECT: (CHECK ONE) | <input type="checkbox"/> Comp/Echo | <input type="checkbox"/> Touch Wah |  EFFECT ADJUST |  REVERB LEVEL |  REVERB DEPTH |
| | <input type="checkbox"/> Acoustic | <input type="checkbox"/> High Power | | <input type="checkbox"/> Comp/Chorus | <input type="checkbox"/> Compressor | | | |
| | <input type="checkbox"/> Blue Voodoo | <input type="checkbox"/> Studio Tweed | | <input type="checkbox"/> Cmp/Flg/Echo | <input type="checkbox"/> Tremolo | | | |
| | <input type="checkbox"/> Vintage Club | <input type="checkbox"/> Black Face | | <input type="checkbox"/> Cmp/Cho/Echo | <input type="checkbox"/> Vibrato | | | |
| | <input type="checkbox"/> Flexwave | <input type="checkbox"/> Large Tweed | | <input type="checkbox"/> Cmp/Vib/Echo | <input type="checkbox"/> Chorus | | | |
| | <input type="checkbox"/> Ampeg VL | <input type="checkbox"/> 60s Era UK | | <input type="checkbox"/> Flange/Echo | <input type="checkbox"/> Flanger | | | |
| <input type="checkbox"/> Calif Mod | <input type="checkbox"/> 70s Era UK | <input type="checkbox"/> Chor/Echo | <input type="checkbox"/> Delay | | | | | |
| <input type="checkbox"/> Tube Rectifier | <input type="checkbox"/> Fuzzbox | <input type="checkbox"/> Rotating Spkr | <input type="checkbox"/> Echo | | | | | |



| | | | | |
|---|---|---|---|---|
|  |  |  |  |  |
| GAIN | BASS | MID | TREBLE | CHANNEL LEVEL |





Preset # 48 *I think I'll call it:* _____ Set TAP for _____ beats/minute

| | | | | | | | | |
|---|---------------------------------------|--|--------------------------------|---------------------------------------|-------------------------------------|--|---|---|
| AMP MODEL: (CHECK ONE) | <input type="checkbox"/> Clean | <input type="checkbox"/> Top Mount | EFFECT: (CHECK ONE) | <input type="checkbox"/> Comp/Echo | <input type="checkbox"/> Touch Wah |  EFFECT ADJUST |  REVERB LEVEL |  REVERB DEPTH |
| | <input type="checkbox"/> Acoustic | <input type="checkbox"/> High Power | | <input type="checkbox"/> Comp/Chorus | <input type="checkbox"/> Compressor | | | |
| | <input type="checkbox"/> Blue Voodoo | <input type="checkbox"/> Studio Tweed | | <input type="checkbox"/> Cmp/Flg/Echo | <input type="checkbox"/> Tremolo | | | |
| | <input type="checkbox"/> Vintage Club | <input type="checkbox"/> Black Face | | <input type="checkbox"/> Cmp/Cho/Echo | <input type="checkbox"/> Vibrato | | | |
| | <input type="checkbox"/> Flexwave | <input type="checkbox"/> Large Tweed | | <input type="checkbox"/> Cmp/Vib/Echo | <input type="checkbox"/> Chorus | | | |
| | <input type="checkbox"/> Ampeg VL | <input type="checkbox"/> 60s Era UK | | <input type="checkbox"/> Flange/Echo | <input type="checkbox"/> Flanger | | | |
| <input type="checkbox"/> Calif Mod | <input type="checkbox"/> 70s Era UK | <input type="checkbox"/> Chor/Echo | <input type="checkbox"/> Delay | | | | | |
| <input type="checkbox"/> Tube Rectifier | <input type="checkbox"/> Fuzzbox | <input type="checkbox"/> Rotating Spkr | <input type="checkbox"/> Echo | | | | | |



| | | | | |
|---|---|---|---|---|
|  |  |  |  |  |
| GAIN | BASS | MID | TREBLE | CHANNEL LEVEL |





Preset # 49 *I think I'll call it:* _____ Set TAP for _____ beats/minute

| | | | | | | | | |
|---|---------------------------------------|--|--------------------------------|---------------------------------------|-------------------------------------|--|---|---|
| AMP MODEL: (CHECK ONE) | <input type="checkbox"/> Clean | <input type="checkbox"/> Top Mount | EFFECT: (CHECK ONE) | <input type="checkbox"/> Comp/Echo | <input type="checkbox"/> Touch Wah |  EFFECT ADJUST |  REVERB LEVEL |  REVERB DEPTH |
| | <input type="checkbox"/> Acoustic | <input type="checkbox"/> High Power | | <input type="checkbox"/> Comp/Chorus | <input type="checkbox"/> Compressor | | | |
| | <input type="checkbox"/> Blue Voodoo | <input type="checkbox"/> Studio Tweed | | <input type="checkbox"/> Cmp/Flg/Echo | <input type="checkbox"/> Tremolo | | | |
| | <input type="checkbox"/> Vintage Club | <input type="checkbox"/> Black Face | | <input type="checkbox"/> Cmp/Cho/Echo | <input type="checkbox"/> Vibrato | | | |
| | <input type="checkbox"/> Flexwave | <input type="checkbox"/> Large Tweed | | <input type="checkbox"/> Cmp/Vib/Echo | <input type="checkbox"/> Chorus | | | |
| | <input type="checkbox"/> Ampeg VL | <input type="checkbox"/> 60s Era UK | | <input type="checkbox"/> Flange/Echo | <input type="checkbox"/> Flanger | | | |
| <input type="checkbox"/> Calif Mod | <input type="checkbox"/> 70s Era UK | <input type="checkbox"/> Chor/Echo | <input type="checkbox"/> Delay | | | | | |
| <input type="checkbox"/> Tube Rectifier | <input type="checkbox"/> Fuzzbox | <input type="checkbox"/> Rotating Spkr | <input type="checkbox"/> Echo | | | | | |

| | | | | |
|---|---|---|---|---|
|  |  |  |  |  |
| GAIN | BASS | MID | TREBLE | CHANNEL LEVEL |

Preset # 50 *I think I'll call it:* _____ Set TAP for _____ beats/minute

| | | | | | | | | |
|---|---------------------------------------|--|--------------------------------|---------------------------------------|-------------------------------------|--|---|---|
| AMP MODEL: (CHECK ONE) | <input type="checkbox"/> Clean | <input type="checkbox"/> Top Mount | EFFECT: (CHECK ONE) | <input type="checkbox"/> Comp/Echo | <input type="checkbox"/> Touch Wah |  EFFECT ADJUST |  REVERB LEVEL |  REVERB DEPTH |
| | <input type="checkbox"/> Acoustic | <input type="checkbox"/> High Power | | <input type="checkbox"/> Comp/Chorus | <input type="checkbox"/> Compressor | | | |
| | <input type="checkbox"/> Blue Voodoo | <input type="checkbox"/> Studio Tweed | | <input type="checkbox"/> Cmp/Flg/Echo | <input type="checkbox"/> Tremolo | | | |
| | <input type="checkbox"/> Vintage Club | <input type="checkbox"/> Black Face | | <input type="checkbox"/> Cmp/Cho/Echo | <input type="checkbox"/> Vibrato | | | |
| | <input type="checkbox"/> Flexwave | <input type="checkbox"/> Large Tweed | | <input type="checkbox"/> Cmp/Vib/Echo | <input type="checkbox"/> Chorus | | | |
| | <input type="checkbox"/> Ampeg VL | <input type="checkbox"/> 60s Era UK | | <input type="checkbox"/> Flange/Echo | <input type="checkbox"/> Flanger | | | |
| <input type="checkbox"/> Calif Mod | <input type="checkbox"/> 70s Era UK | <input type="checkbox"/> Chor/Echo | <input type="checkbox"/> Delay | | | | | |
| <input type="checkbox"/> Tube Rectifier | <input type="checkbox"/> Fuzzbox | <input type="checkbox"/> Rotating Spkr | <input type="checkbox"/> Echo | | | | | |

| | | | | |
|---|---|---|---|---|
|  |  |  |  |  |
| GAIN | BASS | MID | TREBLE | CHANNEL LEVEL |

FAVORITES

CRATE DX-112/212 Digital Guitar Amplifier

USER PRESETS 51-55 - BANK A

Preset # 51 *I think I'll call it:* _____ Set TAP for _____ beats/minute

| | | | | | | | | | |
|---------------------------|---|---------------------------------------|--------------------------------|--|--|--|--|--|-------------------------------------|
| AMP MODEL: (CHECK ONE) | <input type="checkbox"/> Clean | <input type="checkbox"/> Top Mount | EFFECT: (CHECK ONE) | | | | | <input type="checkbox"/> Comp/Echo | <input type="checkbox"/> Touch Wah |
| | <input type="checkbox"/> Acoustic | <input type="checkbox"/> High Power | | | | | | <input type="checkbox"/> Comp/Chorus | <input type="checkbox"/> Compressor |
| | <input type="checkbox"/> Blue Voodoo | <input type="checkbox"/> Studio Tweed | | | | | | <input type="checkbox"/> Cmp/Fly/Echo | <input type="checkbox"/> Tremolo |
| | <input type="checkbox"/> Vintage Club | <input type="checkbox"/> Black Face | | | | | | <input type="checkbox"/> Cmp/Cho/Echo | <input type="checkbox"/> Vibrato |
| | <input type="checkbox"/> Flexwave | <input type="checkbox"/> Large Tweed | | | | | | <input type="checkbox"/> Cmp/Vib/Echo | <input type="checkbox"/> Chorus |
| | <input type="checkbox"/> Ampeg VL | <input type="checkbox"/> 60s Era UK | | | | | | <input type="checkbox"/> Flange/Echo | <input type="checkbox"/> Flanger |
| | <input type="checkbox"/> Calif Mod | <input type="checkbox"/> 70s Era UK | | | | | | <input type="checkbox"/> Chor/Echo | <input type="checkbox"/> Delay |
| | <input type="checkbox"/> Tube Rectifier | <input type="checkbox"/> Fuzzbox | | | | | | <input type="checkbox"/> Rotating Spkr | <input type="checkbox"/> Echo |

| | | | | | | | |
|------|------|-----|--------|---------------|---------------|--------------|--------------|
| | | | | | | | |
| GAIN | BASS | MID | TREBLE | CHANNEL LEVEL | EFFECT ADJUST | REVERB LEVEL | REVERB DEPTH |

Preset # 52 *I think I'll call it:* _____ Set TAP for _____ beats/minute

| | | | | | | | | | |
|---------------------------|---|---------------------------------------|--------------------------------|--|--|--|--|--|-------------------------------------|
| AMP MODEL: (CHECK ONE) | <input type="checkbox"/> Clean | <input type="checkbox"/> Top Mount | EFFECT: (CHECK ONE) | | | | | <input type="checkbox"/> Comp/Echo | <input type="checkbox"/> Touch Wah |
| | <input type="checkbox"/> Acoustic | <input type="checkbox"/> High Power | | | | | | <input type="checkbox"/> Comp/Chorus | <input type="checkbox"/> Compressor |
| | <input type="checkbox"/> Blue Voodoo | <input type="checkbox"/> Studio Tweed | | | | | | <input type="checkbox"/> Cmp/Fly/Echo | <input type="checkbox"/> Tremolo |
| | <input type="checkbox"/> Vintage Club | <input type="checkbox"/> Black Face | | | | | | <input type="checkbox"/> Cmp/Cho/Echo | <input type="checkbox"/> Vibrato |
| | <input type="checkbox"/> Flexwave | <input type="checkbox"/> Large Tweed | | | | | | <input type="checkbox"/> Cmp/Vib/Echo | <input type="checkbox"/> Chorus |
| | <input type="checkbox"/> Ampeg VL | <input type="checkbox"/> 60s Era UK | | | | | | <input type="checkbox"/> Flange/Echo | <input type="checkbox"/> Flanger |
| | <input type="checkbox"/> Calif Mod | <input type="checkbox"/> 70s Era UK | | | | | | <input type="checkbox"/> Chor/Echo | <input type="checkbox"/> Delay |
| | <input type="checkbox"/> Tube Rectifier | <input type="checkbox"/> Fuzzbox | | | | | | <input type="checkbox"/> Rotating Spkr | <input type="checkbox"/> Echo |

| | | | | | | | |
|------|------|-----|--------|---------------|---------------|--------------|--------------|
| | | | | | | | |
| GAIN | BASS | MID | TREBLE | CHANNEL LEVEL | EFFECT ADJUST | REVERB LEVEL | REVERB DEPTH |

Preset # 53 *I think I'll call it:* _____ Set TAP for _____ beats/minute

| | | | | | | | | | |
|---------------------------|---|---------------------------------------|--------------------------------|--|--|--|--|--|-------------------------------------|
| AMP MODEL: (CHECK ONE) | <input type="checkbox"/> Clean | <input type="checkbox"/> Top Mount | EFFECT: (CHECK ONE) | | | | | <input type="checkbox"/> Comp/Echo | <input type="checkbox"/> Touch Wah |
| | <input type="checkbox"/> Acoustic | <input type="checkbox"/> High Power | | | | | | <input type="checkbox"/> Comp/Chorus | <input type="checkbox"/> Compressor |
| | <input type="checkbox"/> Blue Voodoo | <input type="checkbox"/> Studio Tweed | | | | | | <input type="checkbox"/> Cmp/Fly/Echo | <input type="checkbox"/> Tremolo |
| | <input type="checkbox"/> Vintage Club | <input type="checkbox"/> Black Face | | | | | | <input type="checkbox"/> Cmp/Cho/Echo | <input type="checkbox"/> Vibrato |
| | <input type="checkbox"/> Flexwave | <input type="checkbox"/> Large Tweed | | | | | | <input type="checkbox"/> Cmp/Vib/Echo | <input type="checkbox"/> Chorus |
| | <input type="checkbox"/> Ampeg VL | <input type="checkbox"/> 60s Era UK | | | | | | <input type="checkbox"/> Flange/Echo | <input type="checkbox"/> Flanger |
| | <input type="checkbox"/> Calif Mod | <input type="checkbox"/> 70s Era UK | | | | | | <input type="checkbox"/> Chor/Echo | <input type="checkbox"/> Delay |
| | <input type="checkbox"/> Tube Rectifier | <input type="checkbox"/> Fuzzbox | | | | | | <input type="checkbox"/> Rotating Spkr | <input type="checkbox"/> Echo |

| | | | | | | | |
|------|------|-----|--------|---------------|---------------|--------------|--------------|
| | | | | | | | |
| GAIN | BASS | MID | TREBLE | CHANNEL LEVEL | EFFECT ADJUST | REVERB LEVEL | REVERB DEPTH |

Preset # 54 *I think I'll call it:* _____ Set TAP for _____ beats/minute

| | | | | | | | | | |
|---------------------------|---|---------------------------------------|--------------------------------|--|--|--|--|--|-------------------------------------|
| AMP MODEL: (CHECK ONE) | <input type="checkbox"/> Clean | <input type="checkbox"/> Top Mount | EFFECT: (CHECK ONE) | | | | | <input type="checkbox"/> Comp/Echo | <input type="checkbox"/> Touch Wah |
| | <input type="checkbox"/> Acoustic | <input type="checkbox"/> High Power | | | | | | <input type="checkbox"/> Comp/Chorus | <input type="checkbox"/> Compressor |
| | <input type="checkbox"/> Blue Voodoo | <input type="checkbox"/> Studio Tweed | | | | | | <input type="checkbox"/> Cmp/Fly/Echo | <input type="checkbox"/> Tremolo |
| | <input type="checkbox"/> Vintage Club | <input type="checkbox"/> Black Face | | | | | | <input type="checkbox"/> Cmp/Cho/Echo | <input type="checkbox"/> Vibrato |
| | <input type="checkbox"/> Flexwave | <input type="checkbox"/> Large Tweed | | | | | | <input type="checkbox"/> Cmp/Vib/Echo | <input type="checkbox"/> Chorus |
| | <input type="checkbox"/> Ampeg VL | <input type="checkbox"/> 60s Era UK | | | | | | <input type="checkbox"/> Flange/Echo | <input type="checkbox"/> Flanger |
| | <input type="checkbox"/> Calif Mod | <input type="checkbox"/> 70s Era UK | | | | | | <input type="checkbox"/> Chor/Echo | <input type="checkbox"/> Delay |
| | <input type="checkbox"/> Tube Rectifier | <input type="checkbox"/> Fuzzbox | | | | | | <input type="checkbox"/> Rotating Spkr | <input type="checkbox"/> Echo |

| | | | | | | | |
|------|------|-----|--------|---------------|---------------|--------------|--------------|
| | | | | | | | |
| GAIN | BASS | MID | TREBLE | CHANNEL LEVEL | EFFECT ADJUST | REVERB LEVEL | REVERB DEPTH |

Preset # 55 *I think I'll call it:* _____ Set TAP for _____ beats/minute

| | | | | | | | | | |
|---------------------------|---|---------------------------------------|--------------------------------|--|--|--|--|--|-------------------------------------|
| AMP MODEL: (CHECK ONE) | <input type="checkbox"/> Clean | <input type="checkbox"/> Top Mount | EFFECT: (CHECK ONE) | | | | | <input type="checkbox"/> Comp/Echo | <input type="checkbox"/> Touch Wah |
| | <input type="checkbox"/> Acoustic | <input type="checkbox"/> High Power | | | | | | <input type="checkbox"/> Comp/Chorus | <input type="checkbox"/> Compressor |
| | <input type="checkbox"/> Blue Voodoo | <input type="checkbox"/> Studio Tweed | | | | | | <input type="checkbox"/> Cmp/Fly/Echo | <input type="checkbox"/> Tremolo |
| | <input type="checkbox"/> Vintage Club | <input type="checkbox"/> Black Face | | | | | | <input type="checkbox"/> Cmp/Cho/Echo | <input type="checkbox"/> Vibrato |
| | <input type="checkbox"/> Flexwave | <input type="checkbox"/> Large Tweed | | | | | | <input type="checkbox"/> Cmp/Vib/Echo | <input type="checkbox"/> Chorus |
| | <input type="checkbox"/> Ampeg VL | <input type="checkbox"/> 60s Era UK | | | | | | <input type="checkbox"/> Flange/Echo | <input type="checkbox"/> Flanger |
| | <input type="checkbox"/> Calif Mod | <input type="checkbox"/> 70s Era UK | | | | | | <input type="checkbox"/> Chor/Echo | <input type="checkbox"/> Delay |
| | <input type="checkbox"/> Tube Rectifier | <input type="checkbox"/> Fuzzbox | | | | | | <input type="checkbox"/> Rotating Spkr | <input type="checkbox"/> Echo |

| | | | | | | | |
|------|------|-----|--------|---------------|---------------|--------------|--------------|
| | | | | | | | |
| GAIN | BASS | MID | TREBLE | CHANNEL LEVEL | EFFECT ADJUST | REVERB LEVEL | REVERB DEPTH |

DX-112/212 Digital Guitar Amplifier **CRATE**

USER PRESETS 56–60 - BANK B

Preset # 56 *I think I'll call it:* _____ Set TAP for _____ beats/minute

| | | |
|---|---------------------------------------|---------------------------------------|
| AMP MODEL: (CHECK ONE) | <input type="checkbox"/> Clean | <input type="checkbox"/> Top Mount |
| | <input type="checkbox"/> Acoustic | <input type="checkbox"/> High Power |
| | <input type="checkbox"/> Blue Voodoo | <input type="checkbox"/> Studio Tweed |
| | <input type="checkbox"/> Vintage Club | <input type="checkbox"/> Black Face |
| | <input type="checkbox"/> Flexwave | <input type="checkbox"/> Large Tweed |
| | <input type="checkbox"/> Ampeg VL | <input type="checkbox"/> 60s Era UK |
| <input type="checkbox"/> Calif Mod | <input type="checkbox"/> 70s Era UK | |
| <input type="checkbox"/> Tube Rectifier | <input type="checkbox"/> Fuzzbox | |

EFFECT: (CHECK ONE)

| | |
|--|-------------------------------------|
| <input type="checkbox"/> Comp/Echo | <input type="checkbox"/> Touch Wah |
| <input type="checkbox"/> Comp/Chorus | <input type="checkbox"/> Compressor |
| <input type="checkbox"/> Cmp/Flg/Echo | <input type="checkbox"/> Tremolo |
| <input type="checkbox"/> Cmp/Cho/Echo | <input type="checkbox"/> Vibrato |
| <input type="checkbox"/> Cmp/Vib/Echo | <input type="checkbox"/> Chorus |
| <input type="checkbox"/> Flange/Echo | <input type="checkbox"/> Flanger |
| <input type="checkbox"/> Chor/Echo | <input type="checkbox"/> Delay |
| <input type="checkbox"/> Rotating Spkr | <input type="checkbox"/> Echo |



GAIN



BASS



MID



TREBLE



CHANNEL
LEVEL



EFFECT
ADJUST



REVERB
LEVEL



REVERB
DEPTH

Preset # 57 *I think I'll call it:* _____ Set TAP for _____ beats/minute

| | | |
|---|---------------------------------------|---------------------------------------|
| AMP MODEL: (CHECK ONE) | <input type="checkbox"/> Clean | <input type="checkbox"/> Top Mount |
| | <input type="checkbox"/> Acoustic | <input type="checkbox"/> High Power |
| | <input type="checkbox"/> Blue Voodoo | <input type="checkbox"/> Studio Tweed |
| | <input type="checkbox"/> Vintage Club | <input type="checkbox"/> Black Face |
| | <input type="checkbox"/> Flexwave | <input type="checkbox"/> Large Tweed |
| | <input type="checkbox"/> Ampeg VL | <input type="checkbox"/> 60s Era UK |
| <input type="checkbox"/> Calif Mod | <input type="checkbox"/> 70s Era UK | |
| <input type="checkbox"/> Tube Rectifier | <input type="checkbox"/> Fuzzbox | |

EFFECT: (CHECK ONE)

| | |
|--|-------------------------------------|
| <input type="checkbox"/> Comp/Echo | <input type="checkbox"/> Touch Wah |
| <input type="checkbox"/> Comp/Chorus | <input type="checkbox"/> Compressor |
| <input type="checkbox"/> Cmp/Flg/Echo | <input type="checkbox"/> Tremolo |
| <input type="checkbox"/> Cmp/Cho/Echo | <input type="checkbox"/> Vibrato |
| <input type="checkbox"/> Cmp/Vib/Echo | <input type="checkbox"/> Chorus |
| <input type="checkbox"/> Flange/Echo | <input type="checkbox"/> Flanger |
| <input type="checkbox"/> Chor/Echo | <input type="checkbox"/> Delay |
| <input type="checkbox"/> Rotating Spkr | <input type="checkbox"/> Echo |



GAIN



BASS



MID



TREBLE



CHANNEL
LEVEL



EFFECT
ADJUST



REVERB
LEVEL



REVERB
DEPTH

Preset # 58 *I think I'll call it:* _____ Set TAP for _____ beats/minute

| | | |
|---|---------------------------------------|---------------------------------------|
| AMP MODEL: (CHECK ONE) | <input type="checkbox"/> Clean | <input type="checkbox"/> Top Mount |
| | <input type="checkbox"/> Acoustic | <input type="checkbox"/> High Power |
| | <input type="checkbox"/> Blue Voodoo | <input type="checkbox"/> Studio Tweed |
| | <input type="checkbox"/> Vintage Club | <input type="checkbox"/> Black Face |
| | <input type="checkbox"/> Flexwave | <input type="checkbox"/> Large Tweed |
| | <input type="checkbox"/> Ampeg VL | <input type="checkbox"/> 60s Era UK |
| <input type="checkbox"/> Calif Mod | <input type="checkbox"/> 70s Era UK | |
| <input type="checkbox"/> Tube Rectifier | <input type="checkbox"/> Fuzzbox | |

EFFECT: (CHECK ONE)

| | |
|--|-------------------------------------|
| <input type="checkbox"/> Comp/Echo | <input type="checkbox"/> Touch Wah |
| <input type="checkbox"/> Comp/Chorus | <input type="checkbox"/> Compressor |
| <input type="checkbox"/> Cmp/Flg/Echo | <input type="checkbox"/> Tremolo |
| <input type="checkbox"/> Cmp/Cho/Echo | <input type="checkbox"/> Vibrato |
| <input type="checkbox"/> Cmp/Vib/Echo | <input type="checkbox"/> Chorus |
| <input type="checkbox"/> Flange/Echo | <input type="checkbox"/> Flanger |
| <input type="checkbox"/> Chor/Echo | <input type="checkbox"/> Delay |
| <input type="checkbox"/> Rotating Spkr | <input type="checkbox"/> Echo |



GAIN



BASS



MID



TREBLE



CHANNEL
LEVEL



EFFECT
ADJUST



REVERB
LEVEL



REVERB
DEPTH

Preset # 59 *I think I'll call it:* _____ Set TAP for _____ beats/minute

| | | |
|---|---------------------------------------|---------------------------------------|
| AMP MODEL: (CHECK ONE) | <input type="checkbox"/> Clean | <input type="checkbox"/> Top Mount |
| | <input type="checkbox"/> Acoustic | <input type="checkbox"/> High Power |
| | <input type="checkbox"/> Blue Voodoo | <input type="checkbox"/> Studio Tweed |
| | <input type="checkbox"/> Vintage Club | <input type="checkbox"/> Black Face |
| | <input type="checkbox"/> Flexwave | <input type="checkbox"/> Large Tweed |
| | <input type="checkbox"/> Ampeg VL | <input type="checkbox"/> 60s Era UK |
| <input type="checkbox"/> Calif Mod | <input type="checkbox"/> 70s Era UK | |
| <input type="checkbox"/> Tube Rectifier | <input type="checkbox"/> Fuzzbox | |

EFFECT: (CHECK ONE)

| | |
|--|-------------------------------------|
| <input type="checkbox"/> Comp/Echo | <input type="checkbox"/> Touch Wah |
| <input type="checkbox"/> Comp/Chorus | <input type="checkbox"/> Compressor |
| <input type="checkbox"/> Cmp/Flg/Echo | <input type="checkbox"/> Tremolo |
| <input type="checkbox"/> Cmp/Cho/Echo | <input type="checkbox"/> Vibrato |
| <input type="checkbox"/> Cmp/Vib/Echo | <input type="checkbox"/> Chorus |
| <input type="checkbox"/> Flange/Echo | <input type="checkbox"/> Flanger |
| <input type="checkbox"/> Chor/Echo | <input type="checkbox"/> Delay |
| <input type="checkbox"/> Rotating Spkr | <input type="checkbox"/> Echo |



GAIN



BASS



MID



TREBLE



CHANNEL
LEVEL



EFFECT
ADJUST



REVERB
LEVEL



REVERB
DEPTH

Preset # 60 *I think I'll call it:* _____ Set TAP for _____ beats/minute

| | | |
|---|---------------------------------------|---------------------------------------|
| AMP MODEL: (CHECK ONE) | <input type="checkbox"/> Clean | <input type="checkbox"/> Top Mount |
| | <input type="checkbox"/> Acoustic | <input type="checkbox"/> High Power |
| | <input type="checkbox"/> Blue Voodoo | <input type="checkbox"/> Studio Tweed |
| | <input type="checkbox"/> Vintage Club | <input type="checkbox"/> Black Face |
| | <input type="checkbox"/> Flexwave | <input type="checkbox"/> Large Tweed |
| | <input type="checkbox"/> Ampeg VL | <input type="checkbox"/> 60s Era UK |
| <input type="checkbox"/> Calif Mod | <input type="checkbox"/> 70s Era UK | |
| <input type="checkbox"/> Tube Rectifier | <input type="checkbox"/> Fuzzbox | |

EFFECT: (CHECK ONE)

| | |
|--|-------------------------------------|
| <input type="checkbox"/> Comp/Echo | <input type="checkbox"/> Touch Wah |
| <input type="checkbox"/> Comp/Chorus | <input type="checkbox"/> Compressor |
| <input type="checkbox"/> Cmp/Flg/Echo | <input type="checkbox"/> Tremolo |
| <input type="checkbox"/> Cmp/Cho/Echo | <input type="checkbox"/> Vibrato |
| <input type="checkbox"/> Cmp/Vib/Echo | <input type="checkbox"/> Chorus |
| <input type="checkbox"/> Flange/Echo | <input type="checkbox"/> Flanger |
| <input type="checkbox"/> Chor/Echo | <input type="checkbox"/> Delay |
| <input type="checkbox"/> Rotating Spkr | <input type="checkbox"/> Echo |



GAIN



BASS



MID



TREBLE



CHANNEL
LEVEL



EFFECT
ADJUST



REVERB
LEVEL



REVERB
DEPTH

CRATE DX-112/212 Digital Guitar Amplifier

USER PRESETS 61-65 - BANK A

Preset # 61 *I think I'll call it:* _____ Set TAP for _____ beats/minute

| | | | | | | | | | |
|----------------------------------|---|---------------------------------------|--|---------------------------------------|---------------------------------------|--|--|--------------------------------------|-------------------------------------|
| AMP MODEL: (CHECK ONE) | <input type="checkbox"/> Clean | <input type="checkbox"/> Top Mount | EFFECT: (CHECK ONE) | | | | | <input type="checkbox"/> Comp/Echo | <input type="checkbox"/> Touch Wah |
| | <input type="checkbox"/> Acoustic | <input type="checkbox"/> High Power | <input type="checkbox"/> GAIN | <input type="checkbox"/> BASS | <input type="checkbox"/> MID | <input type="checkbox"/> TREBLE | <input type="checkbox"/> CHANNEL LEVEL | <input type="checkbox"/> Comp/Chorus | <input type="checkbox"/> Compressor |
| | <input type="checkbox"/> Blue Voodoo | <input type="checkbox"/> Studio Tweed | <input type="checkbox"/> EFFECT ADJUST | <input type="checkbox"/> REVERB LEVEL | <input type="checkbox"/> REVERB DEPTH | <input type="checkbox"/> Comp/Flg/Echo | <input type="checkbox"/> Tremolo | | |
| | <input type="checkbox"/> Vintage Club | <input type="checkbox"/> Black Face | | | | <input type="checkbox"/> Comp/Cho/Echo | <input type="checkbox"/> Vibrato | | |
| | <input type="checkbox"/> Flexwave | <input type="checkbox"/> Large Tweed | | | | <input type="checkbox"/> Cmp/Vib/Echo | <input type="checkbox"/> Chorus | | |
| | <input type="checkbox"/> Ampeg VL | <input type="checkbox"/> 60s Era UK | | | | <input type="checkbox"/> Flange/Echo | <input type="checkbox"/> Flanger | | |
| | <input type="checkbox"/> Calif Mod | <input type="checkbox"/> 70s Era UK | | | | <input type="checkbox"/> Chor/Echo | <input type="checkbox"/> Delay | | |
| | <input type="checkbox"/> Tube Rectifier | <input type="checkbox"/> Fuzzbox | | | | <input type="checkbox"/> Rotating Spkr | <input type="checkbox"/> Echo | | |

Preset # 62 *I think I'll call it:* _____ Set TAP for _____ beats/minute

| | | | | | | | | | |
|----------------------------------|---|---------------------------------------|--|---------------------------------------|---------------------------------------|--|--|--------------------------------------|-------------------------------------|
| AMP MODEL: (CHECK ONE) | <input type="checkbox"/> Clean | <input type="checkbox"/> Top Mount | EFFECT: (CHECK ONE) | | | | | <input type="checkbox"/> Comp/Echo | <input type="checkbox"/> Touch Wah |
| | <input type="checkbox"/> Acoustic | <input type="checkbox"/> High Power | <input type="checkbox"/> GAIN | <input type="checkbox"/> BASS | <input type="checkbox"/> MID | <input type="checkbox"/> TREBLE | <input type="checkbox"/> CHANNEL LEVEL | <input type="checkbox"/> Comp/Chorus | <input type="checkbox"/> Compressor |
| | <input type="checkbox"/> Blue Voodoo | <input type="checkbox"/> Studio Tweed | <input type="checkbox"/> EFFECT ADJUST | <input type="checkbox"/> REVERB LEVEL | <input type="checkbox"/> REVERB DEPTH | <input type="checkbox"/> Comp/Flg/Echo | <input type="checkbox"/> Tremolo | | |
| | <input type="checkbox"/> Vintage Club | <input type="checkbox"/> Black Face | | | | <input type="checkbox"/> Comp/Cho/Echo | <input type="checkbox"/> Vibrato | | |
| | <input type="checkbox"/> Flexwave | <input type="checkbox"/> Large Tweed | | | | <input type="checkbox"/> Cmp/Vib/Echo | <input type="checkbox"/> Chorus | | |
| | <input type="checkbox"/> Ampeg VL | <input type="checkbox"/> 60s Era UK | | | | <input type="checkbox"/> Flange/Echo | <input type="checkbox"/> Flanger | | |
| | <input type="checkbox"/> Calif Mod | <input type="checkbox"/> 70s Era UK | | | | <input type="checkbox"/> Chor/Echo | <input type="checkbox"/> Delay | | |
| | <input type="checkbox"/> Tube Rectifier | <input type="checkbox"/> Fuzzbox | | | | <input type="checkbox"/> Rotating Spkr | <input type="checkbox"/> Echo | | |

Preset # 63 *I think I'll call it:* _____ Set TAP for _____ beats/minute

| | | | | | | | | | |
|----------------------------------|---|---------------------------------------|--|---------------------------------------|---------------------------------------|--|--|--------------------------------------|-------------------------------------|
| AMP MODEL: (CHECK ONE) | <input type="checkbox"/> Clean | <input type="checkbox"/> Top Mount | EFFECT: (CHECK ONE) | | | | | <input type="checkbox"/> Comp/Echo | <input type="checkbox"/> Touch Wah |
| | <input type="checkbox"/> Acoustic | <input type="checkbox"/> High Power | <input type="checkbox"/> GAIN | <input type="checkbox"/> BASS | <input type="checkbox"/> MID | <input type="checkbox"/> TREBLE | <input type="checkbox"/> CHANNEL LEVEL | <input type="checkbox"/> Comp/Chorus | <input type="checkbox"/> Compressor |
| | <input type="checkbox"/> Blue Voodoo | <input type="checkbox"/> Studio Tweed | <input type="checkbox"/> EFFECT ADJUST | <input type="checkbox"/> REVERB LEVEL | <input type="checkbox"/> REVERB DEPTH | <input type="checkbox"/> Comp/Flg/Echo | <input type="checkbox"/> Tremolo | | |
| | <input type="checkbox"/> Vintage Club | <input type="checkbox"/> Black Face | | | | <input type="checkbox"/> Comp/Cho/Echo | <input type="checkbox"/> Vibrato | | |
| | <input type="checkbox"/> Flexwave | <input type="checkbox"/> Large Tweed | | | | <input type="checkbox"/> Cmp/Vib/Echo | <input type="checkbox"/> Chorus | | |
| | <input type="checkbox"/> Ampeg VL | <input type="checkbox"/> 60s Era UK | | | | <input type="checkbox"/> Flange/Echo | <input type="checkbox"/> Flanger | | |
| | <input type="checkbox"/> Calif Mod | <input type="checkbox"/> 70s Era UK | | | | <input type="checkbox"/> Chor/Echo | <input type="checkbox"/> Delay | | |
| | <input type="checkbox"/> Tube Rectifier | <input type="checkbox"/> Fuzzbox | | | | <input type="checkbox"/> Rotating Spkr | <input type="checkbox"/> Echo | | |

Preset # 64 *I think I'll call it:* _____ Set TAP for _____ beats/minute

| | | | | | | | | | |
|----------------------------------|---|---------------------------------------|--|---------------------------------------|---------------------------------------|--|--|--------------------------------------|-------------------------------------|
| AMP MODEL: (CHECK ONE) | <input type="checkbox"/> Clean | <input type="checkbox"/> Top Mount | EFFECT: (CHECK ONE) | | | | | <input type="checkbox"/> Comp/Echo | <input type="checkbox"/> Touch Wah |
| | <input type="checkbox"/> Acoustic | <input type="checkbox"/> High Power | <input type="checkbox"/> GAIN | <input type="checkbox"/> BASS | <input type="checkbox"/> MID | <input type="checkbox"/> TREBLE | <input type="checkbox"/> CHANNEL LEVEL | <input type="checkbox"/> Comp/Chorus | <input type="checkbox"/> Compressor |
| | <input type="checkbox"/> Blue Voodoo | <input type="checkbox"/> Studio Tweed | <input type="checkbox"/> EFFECT ADJUST | <input type="checkbox"/> REVERB LEVEL | <input type="checkbox"/> REVERB DEPTH | <input type="checkbox"/> Comp/Flg/Echo | <input type="checkbox"/> Tremolo | | |
| | <input type="checkbox"/> Vintage Club | <input type="checkbox"/> Black Face | | | | <input type="checkbox"/> Comp/Cho/Echo | <input type="checkbox"/> Vibrato | | |
| | <input type="checkbox"/> Flexwave | <input type="checkbox"/> Large Tweed | | | | <input type="checkbox"/> Cmp/Vib/Echo | <input type="checkbox"/> Chorus | | |
| | <input type="checkbox"/> Ampeg VL | <input type="checkbox"/> 60s Era UK | | | | <input type="checkbox"/> Flange/Echo | <input type="checkbox"/> Flanger | | |
| | <input type="checkbox"/> Calif Mod | <input type="checkbox"/> 70s Era UK | | | | <input type="checkbox"/> Chor/Echo | <input type="checkbox"/> Delay | | |
| | <input type="checkbox"/> Tube Rectifier | <input type="checkbox"/> Fuzzbox | | | | <input type="checkbox"/> Rotating Spkr | <input type="checkbox"/> Echo | | |

Preset # 65 *I think I'll call it:* _____ Set TAP for _____ beats/minute

| | | | | | | | | | |
|----------------------------------|---|---------------------------------------|--|---------------------------------------|---------------------------------------|--|--|--------------------------------------|-------------------------------------|
| AMP MODEL: (CHECK ONE) | <input type="checkbox"/> Clean | <input type="checkbox"/> Top Mount | EFFECT: (CHECK ONE) | | | | | <input type="checkbox"/> Comp/Echo | <input type="checkbox"/> Touch Wah |
| | <input type="checkbox"/> Acoustic | <input type="checkbox"/> High Power | <input type="checkbox"/> GAIN | <input type="checkbox"/> BASS | <input type="checkbox"/> MID | <input type="checkbox"/> TREBLE | <input type="checkbox"/> CHANNEL LEVEL | <input type="checkbox"/> Comp/Chorus | <input type="checkbox"/> Compressor |
| | <input type="checkbox"/> Blue Voodoo | <input type="checkbox"/> Studio Tweed | <input type="checkbox"/> EFFECT ADJUST | <input type="checkbox"/> REVERB LEVEL | <input type="checkbox"/> REVERB DEPTH | <input type="checkbox"/> Comp/Flg/Echo | <input type="checkbox"/> Tremolo | | |
| | <input type="checkbox"/> Vintage Club | <input type="checkbox"/> Black Face | | | | <input type="checkbox"/> Comp/Cho/Echo | <input type="checkbox"/> Vibrato | | |
| | <input type="checkbox"/> Flexwave | <input type="checkbox"/> Large Tweed | | | | <input type="checkbox"/> Cmp/Vib/Echo | <input type="checkbox"/> Chorus | | |
| | <input type="checkbox"/> Ampeg VL | <input type="checkbox"/> 60s Era UK | | | | <input type="checkbox"/> Flange/Echo | <input type="checkbox"/> Flanger | | |
| | <input type="checkbox"/> Calif Mod | <input type="checkbox"/> 70s Era UK | | | | <input type="checkbox"/> Chor/Echo | <input type="checkbox"/> Delay | | |
| | <input type="checkbox"/> Tube Rectifier | <input type="checkbox"/> Fuzzbox | | | | <input type="checkbox"/> Rotating Spkr | <input type="checkbox"/> Echo | | |

DX-112/212 Digital Guitar Amplifier **CRATE**

USER PRESETS 66–70 - BANK B

Preset # 66 *I think I'll call it:* _____ Set TAP for _____ beats/minute

| | | |
|---|---------------------------------------|---------------------------------------|
| AMP MODEL: (CHECK ONE) | <input type="checkbox"/> Clean | <input type="checkbox"/> Top Mount |
| | <input type="checkbox"/> Acoustic | <input type="checkbox"/> High Power |
| | <input type="checkbox"/> Blue Voodoo | <input type="checkbox"/> Studio Tweed |
| | <input type="checkbox"/> Vintage Club | <input type="checkbox"/> Black Face |
| | <input type="checkbox"/> Flexwave | <input type="checkbox"/> Large Tweed |
| | <input type="checkbox"/> Ampeg VL | <input type="checkbox"/> 60s Era UK |
| | <input type="checkbox"/> Calif Mod | <input type="checkbox"/> 70s Era UK |
| <input type="checkbox"/> Tube Rectifier | <input type="checkbox"/> Fuzzbox | |

EFFECT: (CHECK ONE)

| | |
|--|-------------------------------------|
| <input type="checkbox"/> Comp/Echo | <input type="checkbox"/> Touch Wah |
| <input type="checkbox"/> Comp/Chorus | <input type="checkbox"/> Compressor |
| <input type="checkbox"/> Comp/Flg/Echo | <input type="checkbox"/> Tremolo |
| <input type="checkbox"/> Cmp/Cho/Echo | <input type="checkbox"/> Vibrato |
| <input type="checkbox"/> Cmp/Vib/Echo | <input type="checkbox"/> Chorus |
| <input type="checkbox"/> Flange/Echo | <input type="checkbox"/> Flanger |
| <input type="checkbox"/> Chor/Echo | <input type="checkbox"/> Delay |
| <input type="checkbox"/> Rotating Spkr | <input type="checkbox"/> Echo |



GAIN



BASS



MID



TREBLE



CHANNEL
LEVEL



EFFECT
ADJUST



REVERB
LEVEL



REVERB
DEPTH

Preset # 67 *I think I'll call it:* _____ Set TAP for _____ beats/minute

| | | |
|---|---------------------------------------|---------------------------------------|
| AMP MODEL: (CHECK ONE) | <input type="checkbox"/> Clean | <input type="checkbox"/> Top Mount |
| | <input type="checkbox"/> Acoustic | <input type="checkbox"/> High Power |
| | <input type="checkbox"/> Blue Voodoo | <input type="checkbox"/> Studio Tweed |
| | <input type="checkbox"/> Vintage Club | <input type="checkbox"/> Black Face |
| | <input type="checkbox"/> Flexwave | <input type="checkbox"/> Large Tweed |
| | <input type="checkbox"/> Ampeg VL | <input type="checkbox"/> 60s Era UK |
| | <input type="checkbox"/> Calif Mod | <input type="checkbox"/> 70s Era UK |
| <input type="checkbox"/> Tube Rectifier | <input type="checkbox"/> Fuzzbox | |

EFFECT: (CHECK ONE)

| | |
|--|-------------------------------------|
| <input type="checkbox"/> Comp/Echo | <input type="checkbox"/> Touch Wah |
| <input type="checkbox"/> Comp/Chorus | <input type="checkbox"/> Compressor |
| <input type="checkbox"/> Comp/Flg/Echo | <input type="checkbox"/> Tremolo |
| <input type="checkbox"/> Cmp/Cho/Echo | <input type="checkbox"/> Vibrato |
| <input type="checkbox"/> Cmp/Vib/Echo | <input type="checkbox"/> Chorus |
| <input type="checkbox"/> Flange/Echo | <input type="checkbox"/> Flanger |
| <input type="checkbox"/> Chor/Echo | <input type="checkbox"/> Delay |
| <input type="checkbox"/> Rotating Spkr | <input type="checkbox"/> Echo |



GAIN



BASS



MID



TREBLE



CHANNEL
LEVEL



EFFECT
ADJUST



REVERB
LEVEL



REVERB
DEPTH

Preset # 68 *I think I'll call it:* _____ Set TAP for _____ beats/minute

| | | |
|---|---------------------------------------|---------------------------------------|
| AMP MODEL: (CHECK ONE) | <input type="checkbox"/> Clean | <input type="checkbox"/> Top Mount |
| | <input type="checkbox"/> Acoustic | <input type="checkbox"/> High Power |
| | <input type="checkbox"/> Blue Voodoo | <input type="checkbox"/> Studio Tweed |
| | <input type="checkbox"/> Vintage Club | <input type="checkbox"/> Black Face |
| | <input type="checkbox"/> Flexwave | <input type="checkbox"/> Large Tweed |
| | <input type="checkbox"/> Ampeg VL | <input type="checkbox"/> 60s Era UK |
| | <input type="checkbox"/> Calif Mod | <input type="checkbox"/> 70s Era UK |
| <input type="checkbox"/> Tube Rectifier | <input type="checkbox"/> Fuzzbox | |

EFFECT: (CHECK ONE)

| | |
|--|-------------------------------------|
| <input type="checkbox"/> Comp/Echo | <input type="checkbox"/> Touch Wah |
| <input type="checkbox"/> Comp/Chorus | <input type="checkbox"/> Compressor |
| <input type="checkbox"/> Comp/Flg/Echo | <input type="checkbox"/> Tremolo |
| <input type="checkbox"/> Cmp/Cho/Echo | <input type="checkbox"/> Vibrato |
| <input type="checkbox"/> Cmp/Vib/Echo | <input type="checkbox"/> Chorus |
| <input type="checkbox"/> Flange/Echo | <input type="checkbox"/> Flanger |
| <input type="checkbox"/> Chor/Echo | <input type="checkbox"/> Delay |
| <input type="checkbox"/> Rotating Spkr | <input type="checkbox"/> Echo |



GAIN



BASS



MID



TREBLE



CHANNEL
LEVEL



EFFECT
ADJUST



REVERB
LEVEL



REVERB
DEPTH

Preset # 69 *I think I'll call it:* _____ Set TAP for _____ beats/minute

| | | |
|---|---------------------------------------|---------------------------------------|
| AMP MODEL: (CHECK ONE) | <input type="checkbox"/> Clean | <input type="checkbox"/> Top Mount |
| | <input type="checkbox"/> Acoustic | <input type="checkbox"/> High Power |
| | <input type="checkbox"/> Blue Voodoo | <input type="checkbox"/> Studio Tweed |
| | <input type="checkbox"/> Vintage Club | <input type="checkbox"/> Black Face |
| | <input type="checkbox"/> Flexwave | <input type="checkbox"/> Large Tweed |
| | <input type="checkbox"/> Ampeg VL | <input type="checkbox"/> 60s Era UK |
| | <input type="checkbox"/> Calif Mod | <input type="checkbox"/> 70s Era UK |
| <input type="checkbox"/> Tube Rectifier | <input type="checkbox"/> Fuzzbox | |

EFFECT: (CHECK ONE)

| | |
|--|-------------------------------------|
| <input type="checkbox"/> Comp/Echo | <input type="checkbox"/> Touch Wah |
| <input type="checkbox"/> Comp/Chorus | <input type="checkbox"/> Compressor |
| <input type="checkbox"/> Comp/Flg/Echo | <input type="checkbox"/> Tremolo |
| <input type="checkbox"/> Cmp/Cho/Echo | <input type="checkbox"/> Vibrato |
| <input type="checkbox"/> Cmp/Vib/Echo | <input type="checkbox"/> Chorus |
| <input type="checkbox"/> Flange/Echo | <input type="checkbox"/> Flanger |
| <input type="checkbox"/> Chor/Echo | <input type="checkbox"/> Delay |
| <input type="checkbox"/> Rotating Spkr | <input type="checkbox"/> Echo |



GAIN



BASS



MID



TREBLE



CHANNEL
LEVEL



EFFECT
ADJUST



REVERB
LEVEL



REVERB
DEPTH

Preset # 70 *I think I'll call it:* _____ Set TAP for _____ beats/minute

| | | |
|---|---------------------------------------|---------------------------------------|
| AMP MODEL: (CHECK ONE) | <input type="checkbox"/> Clean | <input type="checkbox"/> Top Mount |
| | <input type="checkbox"/> Acoustic | <input type="checkbox"/> High Power |
| | <input type="checkbox"/> Blue Voodoo | <input type="checkbox"/> Studio Tweed |
| | <input type="checkbox"/> Vintage Club | <input type="checkbox"/> Black Face |
| | <input type="checkbox"/> Flexwave | <input type="checkbox"/> Large Tweed |
| | <input type="checkbox"/> Ampeg VL | <input type="checkbox"/> 60s Era UK |
| | <input type="checkbox"/> Calif Mod | <input type="checkbox"/> 70s Era UK |
| <input type="checkbox"/> Tube Rectifier | <input type="checkbox"/> Fuzzbox | |

EFFECT: (CHECK ONE)

| | |
|--|-------------------------------------|
| <input type="checkbox"/> Comp/Echo | <input type="checkbox"/> Touch Wah |
| <input type="checkbox"/> Comp/Chorus | <input type="checkbox"/> Compressor |
| <input type="checkbox"/> Comp/Flg/Echo | <input type="checkbox"/> Tremolo |
| <input type="checkbox"/> Cmp/Cho/Echo | <input type="checkbox"/> Vibrato |
| <input type="checkbox"/> Cmp/Vib/Echo | <input type="checkbox"/> Chorus |
| <input type="checkbox"/> Flange/Echo | <input type="checkbox"/> Flanger |
| <input type="checkbox"/> Chor/Echo | <input type="checkbox"/> Delay |
| <input type="checkbox"/> Rotating Spkr | <input type="checkbox"/> Echo |



GAIN



BASS



MID



TREBLE



CHANNEL
LEVEL



EFFECT
ADJUST



REVERB
LEVEL



REVERB
DEPTH

FAVORITES

CRATE DX-112/212 Digital Guitar Amplifier

USER PRESETS 71-75 - BANK A

Preset # 71 *I think I'll call it:* _____ Set TAP for _____ beats/minute

| | | | | | | | | | |
|---------------------------|---|---------------------------------------|--------------------------------|--|--|--|--|--|-------------------------------------|
| AMP MODEL: (CHECK ONE) | <input type="checkbox"/> Clean | <input type="checkbox"/> Top Mount | EFFECT: (CHECK ONE) | | | | | <input type="checkbox"/> Comp/Echo | <input type="checkbox"/> Touch Wah |
| | <input type="checkbox"/> Acoustic | <input type="checkbox"/> High Power | | | | | | <input type="checkbox"/> Comp/Chorus | <input type="checkbox"/> Compressor |
| | <input type="checkbox"/> Blue Voodoo | <input type="checkbox"/> Studio Tweed | | | | | | <input type="checkbox"/> Cmp/Fly/Echo | <input type="checkbox"/> Tremolo |
| | <input type="checkbox"/> Vintage Club | <input type="checkbox"/> Black Face | | | | | | <input type="checkbox"/> Cmp/Cho/Echo | <input type="checkbox"/> Vibrato |
| | <input type="checkbox"/> Flexwave | <input type="checkbox"/> Large Tweed | | | | | | <input type="checkbox"/> Cmp/Vib/Echo | <input type="checkbox"/> Chorus |
| | <input type="checkbox"/> Ampeg VL | <input type="checkbox"/> 60s Era UK | | | | | | <input type="checkbox"/> Flange/Echo | <input type="checkbox"/> Flanger |
| | <input type="checkbox"/> Calif Mod | <input type="checkbox"/> 70s Era UK | | | | | | <input type="checkbox"/> Chor/Echo | <input type="checkbox"/> Delay |
| | <input type="checkbox"/> Tube Rectifier | <input type="checkbox"/> Fuzzbox | | | | | | <input type="checkbox"/> Rotating Spkr | <input type="checkbox"/> Echo |

| | | | | | | | |
|------|------|-----|--------|---------------|---------------|--------------|--------------|
| | | | | | | | |
| GAIN | BASS | MID | TREBLE | CHANNEL LEVEL | EFFECT ADJUST | REVERB LEVEL | REVERB DEPTH |

Preset # 72 *I think I'll call it:* _____ Set TAP for _____ beats/minute

| | | | | | | | | | |
|---------------------------|---|---------------------------------------|--------------------------------|--|--|--|--|--|-------------------------------------|
| AMP MODEL: (CHECK ONE) | <input type="checkbox"/> Clean | <input type="checkbox"/> Top Mount | EFFECT: (CHECK ONE) | | | | | <input type="checkbox"/> Comp/Echo | <input type="checkbox"/> Touch Wah |
| | <input type="checkbox"/> Acoustic | <input type="checkbox"/> High Power | | | | | | <input type="checkbox"/> Comp/Chorus | <input type="checkbox"/> Compressor |
| | <input type="checkbox"/> Blue Voodoo | <input type="checkbox"/> Studio Tweed | | | | | | <input type="checkbox"/> Cmp/Fly/Echo | <input type="checkbox"/> Tremolo |
| | <input type="checkbox"/> Vintage Club | <input type="checkbox"/> Black Face | | | | | | <input type="checkbox"/> Cmp/Cho/Echo | <input type="checkbox"/> Vibrato |
| | <input type="checkbox"/> Flexwave | <input type="checkbox"/> Large Tweed | | | | | | <input type="checkbox"/> Cmp/Vib/Echo | <input type="checkbox"/> Chorus |
| | <input type="checkbox"/> Ampeg VL | <input type="checkbox"/> 60s Era UK | | | | | | <input type="checkbox"/> Flange/Echo | <input type="checkbox"/> Flanger |
| | <input type="checkbox"/> Calif Mod | <input type="checkbox"/> 70s Era UK | | | | | | <input type="checkbox"/> Chor/Echo | <input type="checkbox"/> Delay |
| | <input type="checkbox"/> Tube Rectifier | <input type="checkbox"/> Fuzzbox | | | | | | <input type="checkbox"/> Rotating Spkr | <input type="checkbox"/> Echo |

| | | | | | | | |
|------|------|-----|--------|---------------|---------------|--------------|--------------|
| | | | | | | | |
| GAIN | BASS | MID | TREBLE | CHANNEL LEVEL | EFFECT ADJUST | REVERB LEVEL | REVERB DEPTH |

Preset # 73 *I think I'll call it:* _____ Set TAP for _____ beats/minute

| | | | | | | | | | |
|---------------------------|---|---------------------------------------|--------------------------------|--|--|--|--|--|-------------------------------------|
| AMP MODEL: (CHECK ONE) | <input type="checkbox"/> Clean | <input type="checkbox"/> Top Mount | EFFECT: (CHECK ONE) | | | | | <input type="checkbox"/> Comp/Echo | <input type="checkbox"/> Touch Wah |
| | <input type="checkbox"/> Acoustic | <input type="checkbox"/> High Power | | | | | | <input type="checkbox"/> Comp/Chorus | <input type="checkbox"/> Compressor |
| | <input type="checkbox"/> Blue Voodoo | <input type="checkbox"/> Studio Tweed | | | | | | <input type="checkbox"/> Cmp/Fly/Echo | <input type="checkbox"/> Tremolo |
| | <input type="checkbox"/> Vintage Club | <input type="checkbox"/> Black Face | | | | | | <input type="checkbox"/> Cmp/Cho/Echo | <input type="checkbox"/> Vibrato |
| | <input type="checkbox"/> Flexwave | <input type="checkbox"/> Large Tweed | | | | | | <input type="checkbox"/> Cmp/Vib/Echo | <input type="checkbox"/> Chorus |
| | <input type="checkbox"/> Ampeg VL | <input type="checkbox"/> 60s Era UK | | | | | | <input type="checkbox"/> Flange/Echo | <input type="checkbox"/> Flanger |
| | <input type="checkbox"/> Calif Mod | <input type="checkbox"/> 70s Era UK | | | | | | <input type="checkbox"/> Chor/Echo | <input type="checkbox"/> Delay |
| | <input type="checkbox"/> Tube Rectifier | <input type="checkbox"/> Fuzzbox | | | | | | <input type="checkbox"/> Rotating Spkr | <input type="checkbox"/> Echo |

| | | | | | | | |
|------|------|-----|--------|---------------|---------------|--------------|--------------|
| | | | | | | | |
| GAIN | BASS | MID | TREBLE | CHANNEL LEVEL | EFFECT ADJUST | REVERB LEVEL | REVERB DEPTH |

Preset # 74 *I think I'll call it:* _____ Set TAP for _____ beats/minute

| | | | | | | | | | |
|---------------------------|---|---------------------------------------|--------------------------------|--|--|--|--|--|-------------------------------------|
| AMP MODEL: (CHECK ONE) | <input type="checkbox"/> Clean | <input type="checkbox"/> Top Mount | EFFECT: (CHECK ONE) | | | | | <input type="checkbox"/> Comp/Echo | <input type="checkbox"/> Touch Wah |
| | <input type="checkbox"/> Acoustic | <input type="checkbox"/> High Power | | | | | | <input type="checkbox"/> Comp/Chorus | <input type="checkbox"/> Compressor |
| | <input type="checkbox"/> Blue Voodoo | <input type="checkbox"/> Studio Tweed | | | | | | <input type="checkbox"/> Cmp/Fly/Echo | <input type="checkbox"/> Tremolo |
| | <input type="checkbox"/> Vintage Club | <input type="checkbox"/> Black Face | | | | | | <input type="checkbox"/> Cmp/Cho/Echo | <input type="checkbox"/> Vibrato |
| | <input type="checkbox"/> Flexwave | <input type="checkbox"/> Large Tweed | | | | | | <input type="checkbox"/> Cmp/Vib/Echo | <input type="checkbox"/> Chorus |
| | <input type="checkbox"/> Ampeg VL | <input type="checkbox"/> 60s Era UK | | | | | | <input type="checkbox"/> Flange/Echo | <input type="checkbox"/> Flanger |
| | <input type="checkbox"/> Calif Mod | <input type="checkbox"/> 70s Era UK | | | | | | <input type="checkbox"/> Chor/Echo | <input type="checkbox"/> Delay |
| | <input type="checkbox"/> Tube Rectifier | <input type="checkbox"/> Fuzzbox | | | | | | <input type="checkbox"/> Rotating Spkr | <input type="checkbox"/> Echo |

| | | | | | | | |
|------|------|-----|--------|---------------|---------------|--------------|--------------|
| | | | | | | | |
| GAIN | BASS | MID | TREBLE | CHANNEL LEVEL | EFFECT ADJUST | REVERB LEVEL | REVERB DEPTH |

Preset # 75 *I think I'll call it:* _____ Set TAP for _____ beats/minute

| | | | | | | | | | |
|---------------------------|---|---------------------------------------|--------------------------------|--|--|--|--|--|-------------------------------------|
| AMP MODEL: (CHECK ONE) | <input type="checkbox"/> Clean | <input type="checkbox"/> Top Mount | EFFECT: (CHECK ONE) | | | | | <input type="checkbox"/> Comp/Echo | <input type="checkbox"/> Touch Wah |
| | <input type="checkbox"/> Acoustic | <input type="checkbox"/> High Power | | | | | | <input type="checkbox"/> Comp/Chorus | <input type="checkbox"/> Compressor |
| | <input type="checkbox"/> Blue Voodoo | <input type="checkbox"/> Studio Tweed | | | | | | <input type="checkbox"/> Cmp/Fly/Echo | <input type="checkbox"/> Tremolo |
| | <input type="checkbox"/> Vintage Club | <input type="checkbox"/> Black Face | | | | | | <input type="checkbox"/> Cmp/Cho/Echo | <input type="checkbox"/> Vibrato |
| | <input type="checkbox"/> Flexwave | <input type="checkbox"/> Large Tweed | | | | | | <input type="checkbox"/> Cmp/Vib/Echo | <input type="checkbox"/> Chorus |
| | <input type="checkbox"/> Ampeg VL | <input type="checkbox"/> 60s Era UK | | | | | | <input type="checkbox"/> Flange/Echo | <input type="checkbox"/> Flanger |
| | <input type="checkbox"/> Calif Mod | <input type="checkbox"/> 70s Era UK | | | | | | <input type="checkbox"/> Chor/Echo | <input type="checkbox"/> Delay |
| | <input type="checkbox"/> Tube Rectifier | <input type="checkbox"/> Fuzzbox | | | | | | <input type="checkbox"/> Rotating Spkr | <input type="checkbox"/> Echo |

| | | | | | | | |
|------|------|-----|--------|---------------|---------------|--------------|--------------|
| | | | | | | | |
| GAIN | BASS | MID | TREBLE | CHANNEL LEVEL | EFFECT ADJUST | REVERB LEVEL | REVERB DEPTH |

DX-112/212 Digital Guitar Amplifier **CRATE**

USER PRESETS 76–80 - BANK B

Preset # 76 *I think I'll call it:* _____ Set TAP for _____ beats/minute

| | | |
|-----------------------------------|---|---------------------------------------|
| AMP MODEL: (CHECK ONE) | <input type="checkbox"/> Clean | <input type="checkbox"/> Top Mount |
| | <input type="checkbox"/> Acoustic | <input type="checkbox"/> High Power |
| | <input type="checkbox"/> Blue Voodoo | <input type="checkbox"/> Studio Tweed |
| | <input type="checkbox"/> Vintage Club | <input type="checkbox"/> Black Face |
| | <input type="checkbox"/> Flexwave | <input type="checkbox"/> Large Tweed |
| | <input type="checkbox"/> Ampeg VL | <input type="checkbox"/> 60s Era UK |
| | <input type="checkbox"/> Calif Mod | <input type="checkbox"/> 70s Era UK |
| | <input type="checkbox"/> Tube Rectifier | <input type="checkbox"/> Fuzzbox |

EFFECT: (CHECK ONE)

| | |
|--|-------------------------------------|
| <input type="checkbox"/> Comp/Echo | <input type="checkbox"/> Touch Wah |
| <input type="checkbox"/> Comp/Chorus | <input type="checkbox"/> Compressor |
| <input type="checkbox"/> Comp/Flg/Echo | <input type="checkbox"/> Tremolo |
| <input type="checkbox"/> Cmp/Cho/Echo | <input type="checkbox"/> Vibrato |
| <input type="checkbox"/> Cmp/Vib/Echo | <input type="checkbox"/> Chorus |
| <input type="checkbox"/> Flange/Echo | <input type="checkbox"/> Flanger |
| <input type="checkbox"/> Chor/Echo | <input type="checkbox"/> Delay |
| <input type="checkbox"/> Rotating Spkr | <input type="checkbox"/> Echo |



GAIN



BASS



MID



TREBLE



CHANNEL
LEVEL



EFFECT
ADJUST



REVERB
LEVEL



REVERB
DEPTH

Preset # 77 *I think I'll call it:* _____ Set TAP for _____ beats/minute

| | | |
|-----------------------------------|---|---------------------------------------|
| AMP MODEL: (CHECK ONE) | <input type="checkbox"/> Clean | <input type="checkbox"/> Top Mount |
| | <input type="checkbox"/> Acoustic | <input type="checkbox"/> High Power |
| | <input type="checkbox"/> Blue Voodoo | <input type="checkbox"/> Studio Tweed |
| | <input type="checkbox"/> Vintage Club | <input type="checkbox"/> Black Face |
| | <input type="checkbox"/> Flexwave | <input type="checkbox"/> Large Tweed |
| | <input type="checkbox"/> Ampeg VL | <input type="checkbox"/> 60s Era UK |
| | <input type="checkbox"/> Calif Mod | <input type="checkbox"/> 70s Era UK |
| | <input type="checkbox"/> Tube Rectifier | <input type="checkbox"/> Fuzzbox |

EFFECT: (CHECK ONE)

| | |
|--|-------------------------------------|
| <input type="checkbox"/> Comp/Echo | <input type="checkbox"/> Touch Wah |
| <input type="checkbox"/> Comp/Chorus | <input type="checkbox"/> Compressor |
| <input type="checkbox"/> Comp/Flg/Echo | <input type="checkbox"/> Tremolo |
| <input type="checkbox"/> Cmp/Cho/Echo | <input type="checkbox"/> Vibrato |
| <input type="checkbox"/> Cmp/Vib/Echo | <input type="checkbox"/> Chorus |
| <input type="checkbox"/> Flange/Echo | <input type="checkbox"/> Flanger |
| <input type="checkbox"/> Chor/Echo | <input type="checkbox"/> Delay |
| <input type="checkbox"/> Rotating Spkr | <input type="checkbox"/> Echo |



GAIN



BASS



MID



TREBLE



CHANNEL
LEVEL



EFFECT
ADJUST



REVERB
LEVEL



REVERB
DEPTH

Preset # 78 *I think I'll call it:* _____ Set TAP for _____ beats/minute

| | | |
|-----------------------------------|---|---------------------------------------|
| AMP MODEL: (CHECK ONE) | <input type="checkbox"/> Clean | <input type="checkbox"/> Top Mount |
| | <input type="checkbox"/> Acoustic | <input type="checkbox"/> High Power |
| | <input type="checkbox"/> Blue Voodoo | <input type="checkbox"/> Studio Tweed |
| | <input type="checkbox"/> Vintage Club | <input type="checkbox"/> Black Face |
| | <input type="checkbox"/> Flexwave | <input type="checkbox"/> Large Tweed |
| | <input type="checkbox"/> Ampeg VL | <input type="checkbox"/> 60s Era UK |
| | <input type="checkbox"/> Calif Mod | <input type="checkbox"/> 70s Era UK |
| | <input type="checkbox"/> Tube Rectifier | <input type="checkbox"/> Fuzzbox |

EFFECT: (CHECK ONE)

| | |
|--|-------------------------------------|
| <input type="checkbox"/> Comp/Echo | <input type="checkbox"/> Touch Wah |
| <input type="checkbox"/> Comp/Chorus | <input type="checkbox"/> Compressor |
| <input type="checkbox"/> Comp/Flg/Echo | <input type="checkbox"/> Tremolo |
| <input type="checkbox"/> Cmp/Cho/Echo | <input type="checkbox"/> Vibrato |
| <input type="checkbox"/> Cmp/Vib/Echo | <input type="checkbox"/> Chorus |
| <input type="checkbox"/> Flange/Echo | <input type="checkbox"/> Flanger |
| <input type="checkbox"/> Chor/Echo | <input type="checkbox"/> Delay |
| <input type="checkbox"/> Rotating Spkr | <input type="checkbox"/> Echo |



GAIN



BASS



MID



TREBLE



CHANNEL
LEVEL



EFFECT
ADJUST



REVERB
LEVEL



REVERB
DEPTH

Preset # 79 *I think I'll call it:* _____ Set TAP for _____ beats/minute

| | | |
|-----------------------------------|---|---------------------------------------|
| AMP MODEL: (CHECK ONE) | <input type="checkbox"/> Clean | <input type="checkbox"/> Top Mount |
| | <input type="checkbox"/> Acoustic | <input type="checkbox"/> High Power |
| | <input type="checkbox"/> Blue Voodoo | <input type="checkbox"/> Studio Tweed |
| | <input type="checkbox"/> Vintage Club | <input type="checkbox"/> Black Face |
| | <input type="checkbox"/> Flexwave | <input type="checkbox"/> Large Tweed |
| | <input type="checkbox"/> Ampeg VL | <input type="checkbox"/> 60s Era UK |
| | <input type="checkbox"/> Calif Mod | <input type="checkbox"/> 70s Era UK |
| | <input type="checkbox"/> Tube Rectifier | <input type="checkbox"/> Fuzzbox |

EFFECT: (CHECK ONE)

| | |
|--|-------------------------------------|
| <input type="checkbox"/> Comp/Echo | <input type="checkbox"/> Touch Wah |
| <input type="checkbox"/> Comp/Chorus | <input type="checkbox"/> Compressor |
| <input type="checkbox"/> Comp/Flg/Echo | <input type="checkbox"/> Tremolo |
| <input type="checkbox"/> Cmp/Cho/Echo | <input type="checkbox"/> Vibrato |
| <input type="checkbox"/> Cmp/Vib/Echo | <input type="checkbox"/> Chorus |
| <input type="checkbox"/> Flange/Echo | <input type="checkbox"/> Flanger |
| <input type="checkbox"/> Chor/Echo | <input type="checkbox"/> Delay |
| <input type="checkbox"/> Rotating Spkr | <input type="checkbox"/> Echo |



GAIN



BASS



MID



TREBLE



CHANNEL
LEVEL



EFFECT
ADJUST



REVERB
LEVEL



REVERB
DEPTH

Preset # 80 *I think I'll call it:* _____ Set TAP for _____ beats/minute

| | | |
|-----------------------------------|---|---------------------------------------|
| AMP MODEL: (CHECK ONE) | <input type="checkbox"/> Clean | <input type="checkbox"/> Top Mount |
| | <input type="checkbox"/> Acoustic | <input type="checkbox"/> High Power |
| | <input type="checkbox"/> Blue Voodoo | <input type="checkbox"/> Studio Tweed |
| | <input type="checkbox"/> Vintage Club | <input type="checkbox"/> Black Face |
| | <input type="checkbox"/> Flexwave | <input type="checkbox"/> Large Tweed |
| | <input type="checkbox"/> Ampeg VL | <input type="checkbox"/> 60s Era UK |
| | <input type="checkbox"/> Calif Mod | <input type="checkbox"/> 70s Era UK |
| | <input type="checkbox"/> Tube Rectifier | <input type="checkbox"/> Fuzzbox |

EFFECT: (CHECK ONE)

| | |
|--|-------------------------------------|
| <input type="checkbox"/> Comp/Echo | <input type="checkbox"/> Touch Wah |
| <input type="checkbox"/> Comp/Chorus | <input type="checkbox"/> Compressor |
| <input type="checkbox"/> Comp/Flg/Echo | <input type="checkbox"/> Tremolo |
| <input type="checkbox"/> Cmp/Cho/Echo | <input type="checkbox"/> Vibrato |
| <input type="checkbox"/> Cmp/Vib/Echo | <input type="checkbox"/> Chorus |
| <input type="checkbox"/> Flange/Echo | <input type="checkbox"/> Flanger |
| <input type="checkbox"/> Chor/Echo | <input type="checkbox"/> Delay |
| <input type="checkbox"/> Rotating Spkr | <input type="checkbox"/> Echo |



GAIN



BASS



MID



TREBLE



CHANNEL
LEVEL



EFFECT
ADJUST



REVERB
LEVEL



REVERB
DEPTH

FAVORITES

CRATE DX-112/212 Digital Guitar Amplifier

USER PRESETS 81-85 - BANK A

Preset # 81 I think I'll call it: _____ Set TAP for _____ beats/minute

| | | | | | | | | | |
|---|---------------------------------------|--|-------------------------------|--|--|--|--|---------------------------------------|-------------------------------------|
| AMP MODEL: (CHECK ONE) | <input type="checkbox"/> Clean | <input type="checkbox"/> Top Mount | EFFECT: (CHECK ONE) | | | | | <input type="checkbox"/> Comp/Echo | <input type="checkbox"/> Touch Wah |
| | <input type="checkbox"/> Acoustic | <input type="checkbox"/> High Power | | | | | | <input type="checkbox"/> Comp/Chorus | <input type="checkbox"/> Compressor |
| | <input type="checkbox"/> Blue Voodoo | <input type="checkbox"/> Studio Tweed | | | | | | <input type="checkbox"/> Cmp/Flg/Echo | <input type="checkbox"/> Tremolo |
| | <input type="checkbox"/> Vintage Club | <input type="checkbox"/> Black Face | | | | | | <input type="checkbox"/> Cmp/Cho/Echo | <input type="checkbox"/> Vibrato |
| | <input type="checkbox"/> Flexwave | <input type="checkbox"/> Large Tweed | | | | | | <input type="checkbox"/> Cmp/Vib/Echo | <input type="checkbox"/> Chorus |
| | <input type="checkbox"/> Ampeg VL | <input type="checkbox"/> 60s Era UK | | | | | | <input type="checkbox"/> Flange/Echo | <input type="checkbox"/> Flanger |
| | <input type="checkbox"/> Calif Mod | <input type="checkbox"/> 70s Era UK | | | | | | <input type="checkbox"/> Chor/Echo | <input type="checkbox"/> Delay |
| <input type="checkbox"/> Tube Rectifier | <input type="checkbox"/> Fuzzbox | <input type="checkbox"/> Rotating Spkr | <input type="checkbox"/> Echo | | | | | | |

| | | | | | | | |
|------|------|-----|--------|---------------|---------------|--------------|--------------|
| | | | | | | | |
| GAIN | BASS | MID | TREBLE | CHANNEL LEVEL | EFFECT ADJUST | REVERB LEVEL | REVERB DEPTH |

Preset # 82 I think I'll call it: _____ Set TAP for _____ beats/minute

| | | | | | | | | | |
|---|---------------------------------------|--|-------------------------------|--|--|--|--|---------------------------------------|-------------------------------------|
| AMP MODEL: (CHECK ONE) | <input type="checkbox"/> Clean | <input type="checkbox"/> Top Mount | EFFECT: (CHECK ONE) | | | | | <input type="checkbox"/> Comp/Echo | <input type="checkbox"/> Touch Wah |
| | <input type="checkbox"/> Acoustic | <input type="checkbox"/> High Power | | | | | | <input type="checkbox"/> Comp/Chorus | <input type="checkbox"/> Compressor |
| | <input type="checkbox"/> Blue Voodoo | <input type="checkbox"/> Studio Tweed | | | | | | <input type="checkbox"/> Cmp/Flg/Echo | <input type="checkbox"/> Tremolo |
| | <input type="checkbox"/> Vintage Club | <input type="checkbox"/> Black Face | | | | | | <input type="checkbox"/> Cmp/Cho/Echo | <input type="checkbox"/> Vibrato |
| | <input type="checkbox"/> Flexwave | <input type="checkbox"/> Large Tweed | | | | | | <input type="checkbox"/> Cmp/Vib/Echo | <input type="checkbox"/> Chorus |
| | <input type="checkbox"/> Ampeg VL | <input type="checkbox"/> 60s Era UK | | | | | | <input type="checkbox"/> Flange/Echo | <input type="checkbox"/> Flanger |
| | <input type="checkbox"/> Calif Mod | <input type="checkbox"/> 70s Era UK | | | | | | <input type="checkbox"/> Chor/Echo | <input type="checkbox"/> Delay |
| <input type="checkbox"/> Tube Rectifier | <input type="checkbox"/> Fuzzbox | <input type="checkbox"/> Rotating Spkr | <input type="checkbox"/> Echo | | | | | | |

| | | | | | | | |
|------|------|-----|--------|---------------|---------------|--------------|--------------|
| | | | | | | | |
| GAIN | BASS | MID | TREBLE | CHANNEL LEVEL | EFFECT ADJUST | REVERB LEVEL | REVERB DEPTH |

Preset # 83 I think I'll call it: _____ Set TAP for _____ beats/minute

| | | | | | | | | | |
|---|---------------------------------------|--|-------------------------------|--|--|--|--|---------------------------------------|-------------------------------------|
| AMP MODEL: (CHECK ONE) | <input type="checkbox"/> Clean | <input type="checkbox"/> Top Mount | EFFECT: (CHECK ONE) | | | | | <input type="checkbox"/> Comp/Echo | <input type="checkbox"/> Touch Wah |
| | <input type="checkbox"/> Acoustic | <input type="checkbox"/> High Power | | | | | | <input type="checkbox"/> Comp/Chorus | <input type="checkbox"/> Compressor |
| | <input type="checkbox"/> Blue Voodoo | <input type="checkbox"/> Studio Tweed | | | | | | <input type="checkbox"/> Cmp/Flg/Echo | <input type="checkbox"/> Tremolo |
| | <input type="checkbox"/> Vintage Club | <input type="checkbox"/> Black Face | | | | | | <input type="checkbox"/> Cmp/Cho/Echo | <input type="checkbox"/> Vibrato |
| | <input type="checkbox"/> Flexwave | <input type="checkbox"/> Large Tweed | | | | | | <input type="checkbox"/> Cmp/Vib/Echo | <input type="checkbox"/> Chorus |
| | <input type="checkbox"/> Ampeg VL | <input type="checkbox"/> 60s Era UK | | | | | | <input type="checkbox"/> Flange/Echo | <input type="checkbox"/> Flanger |
| | <input type="checkbox"/> Calif Mod | <input type="checkbox"/> 70s Era UK | | | | | | <input type="checkbox"/> Chor/Echo | <input type="checkbox"/> Delay |
| <input type="checkbox"/> Tube Rectifier | <input type="checkbox"/> Fuzzbox | <input type="checkbox"/> Rotating Spkr | <input type="checkbox"/> Echo | | | | | | |

| | | | | | | | |
|------|------|-----|--------|---------------|---------------|--------------|--------------|
| | | | | | | | |
| GAIN | BASS | MID | TREBLE | CHANNEL LEVEL | EFFECT ADJUST | REVERB LEVEL | REVERB DEPTH |

Preset # 84 I think I'll call it: _____ Set TAP for _____ beats/minute

| | | | | | | | | | |
|---|---------------------------------------|--|-------------------------------|--|--|--|--|---------------------------------------|-------------------------------------|
| AMP MODEL: (CHECK ONE) | <input type="checkbox"/> Clean | <input type="checkbox"/> Top Mount | EFFECT: (CHECK ONE) | | | | | <input type="checkbox"/> Comp/Echo | <input type="checkbox"/> Touch Wah |
| | <input type="checkbox"/> Acoustic | <input type="checkbox"/> High Power | | | | | | <input type="checkbox"/> Comp/Chorus | <input type="checkbox"/> Compressor |
| | <input type="checkbox"/> Blue Voodoo | <input type="checkbox"/> Studio Tweed | | | | | | <input type="checkbox"/> Cmp/Flg/Echo | <input type="checkbox"/> Tremolo |
| | <input type="checkbox"/> Vintage Club | <input type="checkbox"/> Black Face | | | | | | <input type="checkbox"/> Cmp/Cho/Echo | <input type="checkbox"/> Vibrato |
| | <input type="checkbox"/> Flexwave | <input type="checkbox"/> Large Tweed | | | | | | <input type="checkbox"/> Cmp/Vib/Echo | <input type="checkbox"/> Chorus |
| | <input type="checkbox"/> Ampeg VL | <input type="checkbox"/> 60s Era UK | | | | | | <input type="checkbox"/> Flange/Echo | <input type="checkbox"/> Flanger |
| | <input type="checkbox"/> Calif Mod | <input type="checkbox"/> 70s Era UK | | | | | | <input type="checkbox"/> Chor/Echo | <input type="checkbox"/> Delay |
| <input type="checkbox"/> Tube Rectifier | <input type="checkbox"/> Fuzzbox | <input type="checkbox"/> Rotating Spkr | <input type="checkbox"/> Echo | | | | | | |

| | | | | | | | |
|------|------|-----|--------|---------------|---------------|--------------|--------------|
| | | | | | | | |
| GAIN | BASS | MID | TREBLE | CHANNEL LEVEL | EFFECT ADJUST | REVERB LEVEL | REVERB DEPTH |

Preset # 85 I think I'll call it: _____ Set TAP for _____ beats/minute

| | | | | | | | | | |
|---|---------------------------------------|--|-------------------------------|--|--|--|--|---------------------------------------|-------------------------------------|
| AMP MODEL: (CHECK ONE) | <input type="checkbox"/> Clean | <input type="checkbox"/> Top Mount | EFFECT: (CHECK ONE) | | | | | <input type="checkbox"/> Comp/Echo | <input type="checkbox"/> Touch Wah |
| | <input type="checkbox"/> Acoustic | <input type="checkbox"/> High Power | | | | | | <input type="checkbox"/> Comp/Chorus | <input type="checkbox"/> Compressor |
| | <input type="checkbox"/> Blue Voodoo | <input type="checkbox"/> Studio Tweed | | | | | | <input type="checkbox"/> Cmp/Flg/Echo | <input type="checkbox"/> Tremolo |
| | <input type="checkbox"/> Vintage Club | <input type="checkbox"/> Black Face | | | | | | <input type="checkbox"/> Cmp/Cho/Echo | <input type="checkbox"/> Vibrato |
| | <input type="checkbox"/> Flexwave | <input type="checkbox"/> Large Tweed | | | | | | <input type="checkbox"/> Cmp/Vib/Echo | <input type="checkbox"/> Chorus |
| | <input type="checkbox"/> Ampeg VL | <input type="checkbox"/> 60s Era UK | | | | | | <input type="checkbox"/> Flange/Echo | <input type="checkbox"/> Flanger |
| | <input type="checkbox"/> Calif Mod | <input type="checkbox"/> 70s Era UK | | | | | | <input type="checkbox"/> Chor/Echo | <input type="checkbox"/> Delay |
| <input type="checkbox"/> Tube Rectifier | <input type="checkbox"/> Fuzzbox | <input type="checkbox"/> Rotating Spkr | <input type="checkbox"/> Echo | | | | | | |

| | | | | | | | |
|------|------|-----|--------|---------------|---------------|--------------|--------------|
| | | | | | | | |
| GAIN | BASS | MID | TREBLE | CHANNEL LEVEL | EFFECT ADJUST | REVERB LEVEL | REVERB DEPTH |

DX-112/212 Digital Guitar Amplifier **CRATE**

USER PRESETS 86–90 - BANK B

Preset # 86 *I think I'll call it:* _____ Set TAP for _____ beats/minute

| | | |
|---|---------------------------------------|---------------------------------------|
| AMP MODEL: (CHECK ONE) | <input type="checkbox"/> Clean | <input type="checkbox"/> Top Mount |
| | <input type="checkbox"/> Acoustic | <input type="checkbox"/> High Power |
| | <input type="checkbox"/> Blue Voodoo | <input type="checkbox"/> Studio Tweed |
| | <input type="checkbox"/> Vintage Club | <input type="checkbox"/> Black Face |
| | <input type="checkbox"/> Flexwave | <input type="checkbox"/> Large Tweed |
| | <input type="checkbox"/> Ampeg VL | <input type="checkbox"/> 60s Era UK |
| <input type="checkbox"/> Calif Mod | <input type="checkbox"/> 70s Era UK | |
| <input type="checkbox"/> Tube Rectifier | <input type="checkbox"/> Fuzzbox | |

EFFECT: (CHECK ONE)

| | |
|--|-------------------------------------|
| <input type="checkbox"/> Comp/Echo | <input type="checkbox"/> Touch Wah |
| <input type="checkbox"/> Comp/Chorus | <input type="checkbox"/> Compressor |
| <input type="checkbox"/> Comp/Flg/Echo | <input type="checkbox"/> Tremolo |
| <input type="checkbox"/> Cmp/Cho/Echo | <input type="checkbox"/> Vibrato |
| <input type="checkbox"/> Cmp/Vib/Echo | <input type="checkbox"/> Chorus |
| <input type="checkbox"/> Flange/Echo | <input type="checkbox"/> Flanger |
| <input type="checkbox"/> Chor/Echo | <input type="checkbox"/> Delay |
| <input type="checkbox"/> Rotating Spkr | <input type="checkbox"/> Echo |



GAIN



BASS



MID



TREBLE



CHANNEL
LEVEL



EFFECT
ADJUST



REVERB
LEVEL



REVERB
DEPTH

Preset # 87 *I think I'll call it:* _____ Set TAP for _____ beats/minute

| | | |
|---|---------------------------------------|---------------------------------------|
| AMP MODEL: (CHECK ONE) | <input type="checkbox"/> Clean | <input type="checkbox"/> Top Mount |
| | <input type="checkbox"/> Acoustic | <input type="checkbox"/> High Power |
| | <input type="checkbox"/> Blue Voodoo | <input type="checkbox"/> Studio Tweed |
| | <input type="checkbox"/> Vintage Club | <input type="checkbox"/> Black Face |
| | <input type="checkbox"/> Flexwave | <input type="checkbox"/> Large Tweed |
| | <input type="checkbox"/> Ampeg VL | <input type="checkbox"/> 60s Era UK |
| <input type="checkbox"/> Calif Mod | <input type="checkbox"/> 70s Era UK | |
| <input type="checkbox"/> Tube Rectifier | <input type="checkbox"/> Fuzzbox | |

EFFECT: (CHECK ONE)

| | |
|--|-------------------------------------|
| <input type="checkbox"/> Comp/Echo | <input type="checkbox"/> Touch Wah |
| <input type="checkbox"/> Comp/Chorus | <input type="checkbox"/> Compressor |
| <input type="checkbox"/> Comp/Flg/Echo | <input type="checkbox"/> Tremolo |
| <input type="checkbox"/> Cmp/Cho/Echo | <input type="checkbox"/> Vibrato |
| <input type="checkbox"/> Cmp/Vib/Echo | <input type="checkbox"/> Chorus |
| <input type="checkbox"/> Flange/Echo | <input type="checkbox"/> Flanger |
| <input type="checkbox"/> Chor/Echo | <input type="checkbox"/> Delay |
| <input type="checkbox"/> Rotating Spkr | <input type="checkbox"/> Echo |



GAIN



BASS



MID



TREBLE



CHANNEL
LEVEL



EFFECT
ADJUST



REVERB
LEVEL



REVERB
DEPTH

Preset # 88 *I think I'll call it:* _____ Set TAP for _____ beats/minute

| | | |
|---|---------------------------------------|---------------------------------------|
| AMP MODEL: (CHECK ONE) | <input type="checkbox"/> Clean | <input type="checkbox"/> Top Mount |
| | <input type="checkbox"/> Acoustic | <input type="checkbox"/> High Power |
| | <input type="checkbox"/> Blue Voodoo | <input type="checkbox"/> Studio Tweed |
| | <input type="checkbox"/> Vintage Club | <input type="checkbox"/> Black Face |
| | <input type="checkbox"/> Flexwave | <input type="checkbox"/> Large Tweed |
| | <input type="checkbox"/> Ampeg VL | <input type="checkbox"/> 60s Era UK |
| <input type="checkbox"/> Calif Mod | <input type="checkbox"/> 70s Era UK | |
| <input type="checkbox"/> Tube Rectifier | <input type="checkbox"/> Fuzzbox | |

EFFECT: (CHECK ONE)

| | |
|--|-------------------------------------|
| <input type="checkbox"/> Comp/Echo | <input type="checkbox"/> Touch Wah |
| <input type="checkbox"/> Comp/Chorus | <input type="checkbox"/> Compressor |
| <input type="checkbox"/> Comp/Flg/Echo | <input type="checkbox"/> Tremolo |
| <input type="checkbox"/> Cmp/Cho/Echo | <input type="checkbox"/> Vibrato |
| <input type="checkbox"/> Cmp/Vib/Echo | <input type="checkbox"/> Chorus |
| <input type="checkbox"/> Flange/Echo | <input type="checkbox"/> Flanger |
| <input type="checkbox"/> Chor/Echo | <input type="checkbox"/> Delay |
| <input type="checkbox"/> Rotating Spkr | <input type="checkbox"/> Echo |



GAIN



BASS



MID



TREBLE



CHANNEL
LEVEL



EFFECT
ADJUST



REVERB
LEVEL



REVERB
DEPTH

Preset # 89 *I think I'll call it:* _____ Set TAP for _____ beats/minute

| | | |
|---|---------------------------------------|---------------------------------------|
| AMP MODEL: (CHECK ONE) | <input type="checkbox"/> Clean | <input type="checkbox"/> Top Mount |
| | <input type="checkbox"/> Acoustic | <input type="checkbox"/> High Power |
| | <input type="checkbox"/> Blue Voodoo | <input type="checkbox"/> Studio Tweed |
| | <input type="checkbox"/> Vintage Club | <input type="checkbox"/> Black Face |
| | <input type="checkbox"/> Flexwave | <input type="checkbox"/> Large Tweed |
| | <input type="checkbox"/> Ampeg VL | <input type="checkbox"/> 60s Era UK |
| <input type="checkbox"/> Calif Mod | <input type="checkbox"/> 70s Era UK | |
| <input type="checkbox"/> Tube Rectifier | <input type="checkbox"/> Fuzzbox | |

EFFECT: (CHECK ONE)

| | |
|--|-------------------------------------|
| <input type="checkbox"/> Comp/Echo | <input type="checkbox"/> Touch Wah |
| <input type="checkbox"/> Comp/Chorus | <input type="checkbox"/> Compressor |
| <input type="checkbox"/> Comp/Flg/Echo | <input type="checkbox"/> Tremolo |
| <input type="checkbox"/> Cmp/Cho/Echo | <input type="checkbox"/> Vibrato |
| <input type="checkbox"/> Cmp/Vib/Echo | <input type="checkbox"/> Chorus |
| <input type="checkbox"/> Flange/Echo | <input type="checkbox"/> Flanger |
| <input type="checkbox"/> Chor/Echo | <input type="checkbox"/> Delay |
| <input type="checkbox"/> Rotating Spkr | <input type="checkbox"/> Echo |



GAIN



BASS



MID



TREBLE



CHANNEL
LEVEL



EFFECT
ADJUST



REVERB
LEVEL



REVERB
DEPTH

Preset # 90 *I think I'll call it:* _____ Set TAP for _____ beats/minute

| | | |
|---|---------------------------------------|---------------------------------------|
| AMP MODEL: (CHECK ONE) | <input type="checkbox"/> Clean | <input type="checkbox"/> Top Mount |
| | <input type="checkbox"/> Acoustic | <input type="checkbox"/> High Power |
| | <input type="checkbox"/> Blue Voodoo | <input type="checkbox"/> Studio Tweed |
| | <input type="checkbox"/> Vintage Club | <input type="checkbox"/> Black Face |
| | <input type="checkbox"/> Flexwave | <input type="checkbox"/> Large Tweed |
| | <input type="checkbox"/> Ampeg VL | <input type="checkbox"/> 60s Era UK |
| <input type="checkbox"/> Calif Mod | <input type="checkbox"/> 70s Era UK | |
| <input type="checkbox"/> Tube Rectifier | <input type="checkbox"/> Fuzzbox | |

EFFECT: (CHECK ONE)

| | |
|--|-------------------------------------|
| <input type="checkbox"/> Comp/Echo | <input type="checkbox"/> Touch Wah |
| <input type="checkbox"/> Comp/Chorus | <input type="checkbox"/> Compressor |
| <input type="checkbox"/> Comp/Flg/Echo | <input type="checkbox"/> Tremolo |
| <input type="checkbox"/> Cmp/Cho/Echo | <input type="checkbox"/> Vibrato |
| <input type="checkbox"/> Cmp/Vib/Echo | <input type="checkbox"/> Chorus |
| <input type="checkbox"/> Flange/Echo | <input type="checkbox"/> Flanger |
| <input type="checkbox"/> Chor/Echo | <input type="checkbox"/> Delay |
| <input type="checkbox"/> Rotating Spkr | <input type="checkbox"/> Echo |



GAIN



BASS



MID



TREBLE



CHANNEL
LEVEL



EFFECT
ADJUST



REVERB
LEVEL











REVERB
DEPTH









CRATE DX-112/212 Digital Guitar Amplifier

USER PRESETS 91-95 - BANK A









Preset # 91 I think I'll call it: _____ Set TAP for _____ beats/minute

| | | | | | | | | | | | | | | | | | | | | | |
|---------------------------|---|---------------------------------------|-------------------------------|--|--|--|--|--|------------------------------------|---|---|---|---|---|-----------------------------------|-------------------------------------|--------------------------------------|-------------------------------------|---|---|---|
| AMP MODEL: (CHECK ONE) | <input type="checkbox"/> Clean | <input type="checkbox"/> Top Mount | EFFECT: (CHECK ONE) | | | | | <input type="checkbox"/> Comp/Echo | <input type="checkbox"/> Touch Wah |  |  |  |  |  | <input type="checkbox"/> Acoustic | <input type="checkbox"/> High Power | <input type="checkbox"/> Comp/Chorus | <input type="checkbox"/> Compressor |  |  |  |
| | <input type="checkbox"/> Blue Voodoo | <input type="checkbox"/> Studio Tweed | | | | | | <input type="checkbox"/> Cmp/Flg/Echo | <input type="checkbox"/> Tremolo | | | | | | | | | | | | |
| | <input type="checkbox"/> Vintage Club | <input type="checkbox"/> Black Face | | | | | | <input type="checkbox"/> Cmp/Cho/Echo | <input type="checkbox"/> Vibrato | | | | | | | | | | | | |
| | <input type="checkbox"/> Flexwave | <input type="checkbox"/> Large Tweed | | | | | | <input type="checkbox"/> Cmp/Vib/Echo | <input type="checkbox"/> Chorus | | | | | | | | | | | | |
| | <input type="checkbox"/> Ampeg VL | <input type="checkbox"/> 60s Era UK | | | | | | <input type="checkbox"/> Flange/Echo | <input type="checkbox"/> Flanger | | | | | | | | | | | | |
| | <input type="checkbox"/> Calif Mod | <input type="checkbox"/> 70s Era UK | | | | | | <input type="checkbox"/> Chor/Echo | <input type="checkbox"/> Delay | | | | | | | | | | | | |
| | <input type="checkbox"/> Tube Rectifier | <input type="checkbox"/> Fuzzbox | | | | | | <input type="checkbox"/> Rotating Spkr | <input type="checkbox"/> Echo | | | | | | | | | | | | |









Preset # 92 I think I'll call it: _____ Set TAP for _____ beats/minute

| | | | | | | | | | | | | | | | | | | | | | |
|---------------------------|---|---------------------------------------|-------------------------------|--|--|--|--|--|------------------------------------|---|---|---|---|---|-----------------------------------|-------------------------------------|--------------------------------------|-------------------------------------|---|---|---|
| AMP MODEL: (CHECK ONE) | <input type="checkbox"/> Clean | <input type="checkbox"/> Top Mount | EFFECT: (CHECK ONE) | | | | | <input type="checkbox"/> Comp/Echo | <input type="checkbox"/> Touch Wah |  |  |  |  |  | <input type="checkbox"/> Acoustic | <input type="checkbox"/> High Power | <input type="checkbox"/> Comp/Chorus | <input type="checkbox"/> Compressor |  |  |  |
| | <input type="checkbox"/> Blue Voodoo | <input type="checkbox"/> Studio Tweed | | | | | | <input type="checkbox"/> Cmp/Flg/Echo | <input type="checkbox"/> Tremolo | | | | | | | | | | | | |
| | <input type="checkbox"/> Vintage Club | <input type="checkbox"/> Black Face | | | | | | <input type="checkbox"/> Cmp/Cho/Echo | <input type="checkbox"/> Vibrato | | | | | | | | | | | | |
| | <input type="checkbox"/> Flexwave | <input type="checkbox"/> Large Tweed | | | | | | <input type="checkbox"/> Cmp/Vib/Echo | <input type="checkbox"/> Chorus | | | | | | | | | | | | |
| | <input type="checkbox"/> Ampeg VL | <input type="checkbox"/> 60s Era UK | | | | | | <input type="checkbox"/> Flange/Echo | <input type="checkbox"/> Flanger | | | | | | | | | | | | |
| | <input type="checkbox"/> Calif Mod | <input type="checkbox"/> 70s Era UK | | | | | | <input type="checkbox"/> Chor/Echo | <input type="checkbox"/> Delay | | | | | | | | | | | | |
| | <input type="checkbox"/> Tube Rectifier | <input type="checkbox"/> Fuzzbox | | | | | | <input type="checkbox"/> Rotating Spkr | <input type="checkbox"/> Echo | | | | | | | | | | | | |









Preset # 93 I think I'll call it: _____ Set TAP for _____ beats/minute

| | | | | | | | | | | | | | | | | | | | | | |
|---------------------------|---|---------------------------------------|-------------------------------|--|--|--|--|--|------------------------------------|---|---|---|---|---|-----------------------------------|-------------------------------------|--------------------------------------|-------------------------------------|---|---|---|
| AMP MODEL: (CHECK ONE) | <input type="checkbox"/> Clean | <input type="checkbox"/> Top Mount | EFFECT: (CHECK ONE) | | | | | <input type="checkbox"/> Comp/Echo | <input type="checkbox"/> Touch Wah |  |  |  |  |  | <input type="checkbox"/> Acoustic | <input type="checkbox"/> High Power | <input type="checkbox"/> Comp/Chorus | <input type="checkbox"/> Compressor |  |  |  |
| | <input type="checkbox"/> Blue Voodoo | <input type="checkbox"/> Studio Tweed | | | | | | <input type="checkbox"/> Cmp/Flg/Echo | <input type="checkbox"/> Tremolo | | | | | | | | | | | | |
| | <input type="checkbox"/> Vintage Club | <input type="checkbox"/> Black Face | | | | | | <input type="checkbox"/> Cmp/Cho/Echo | <input type="checkbox"/> Vibrato | | | | | | | | | | | | |
| | <input type="checkbox"/> Flexwave | <input type="checkbox"/> Large Tweed | | | | | | <input type="checkbox"/> Cmp/Vib/Echo | <input type="checkbox"/> Chorus | | | | | | | | | | | | |
| | <input type="checkbox"/> Ampeg VL | <input type="checkbox"/> 60s Era UK | | | | | | <input type="checkbox"/> Flange/Echo | <input type="checkbox"/> Flanger | | | | | | | | | | | | |
| | <input type="checkbox"/> Calif Mod | <input type="checkbox"/> 70s Era UK | | | | | | <input type="checkbox"/> Chor/Echo | <input type="checkbox"/> Delay | | | | | | | | | | | | |
| | <input type="checkbox"/> Tube Rectifier | <input type="checkbox"/> Fuzzbox | | | | | | <input type="checkbox"/> Rotating Spkr | <input type="checkbox"/> Echo | | | | | | | | | | | | |

Preset # 94 I think I'll call it: _____ Set TAP for _____ beats/minute

| | | | | | | | | | | | | | | | | | | | | | |
|---------------------------|---|---------------------------------------|-------------------------------|--|--|--|--|--|------------------------------------|---|---|---|---|---|-----------------------------------|-------------------------------------|--------------------------------------|-------------------------------------|---|---|---|
| AMP MODEL: (CHECK ONE) | <input type="checkbox"/> Clean | <input type="checkbox"/> Top Mount | EFFECT: (CHECK ONE) | | | | | <input type="checkbox"/> Comp/Echo | <input type="checkbox"/> Touch Wah |  |  |  |  |  | <input type="checkbox"/> Acoustic | <input type="checkbox"/> High Power | <input type="checkbox"/> Comp/Chorus | <input type="checkbox"/> Compressor |  |  |  |
| | <input type="checkbox"/> Blue Voodoo | <input type="checkbox"/> Studio Tweed | | | | | | <input type="checkbox"/> Cmp/Flg/Echo | <input type="checkbox"/> Tremolo | | | | | | | | | | | | |
| | <input type="checkbox"/> Vintage Club | <input type="checkbox"/> Black Face | | | | | | <input type="checkbox"/> Cmp/Cho/Echo | <input type="checkbox"/> Vibrato | | | | | | | | | | | | |
| | <input type="checkbox"/> Flexwave | <input type="checkbox"/> Large Tweed | | | | | | <input type="checkbox"/> Cmp/Vib/Echo | <input type="checkbox"/> Chorus | | | | | | | | | | | | |
| | <input type="checkbox"/> Ampeg VL | <input type="checkbox"/> 60s Era UK | | | | | | <input type="checkbox"/> Flange/Echo | <input type="checkbox"/> Flanger | | | | | | | | | | | | |
| | <input type="checkbox"/> Calif Mod | <input type="checkbox"/> 70s Era UK | | | | | | <input type="checkbox"/> Chor/Echo | <input type="checkbox"/> Delay | | | | | | | | | | | | |
| | <input type="checkbox"/> Tube Rectifier | <input type="checkbox"/> Fuzzbox | | | | | | <input type="checkbox"/> Rotating Spkr | <input type="checkbox"/> Echo | | | | | | | | | | | | |

Preset # 95 I think I'll call it: _____ Set TAP for _____ beats/minute

| | | | | | | | | | | | | | | | | | | | | | |
|---------------------------|---|---------------------------------------|-------------------------------|--|--|--|--|--|------------------------------------|---|---|---|---|---|-----------------------------------|-------------------------------------|--------------------------------------|-------------------------------------|---|---|---|
| AMP MODEL: (CHECK ONE) | <input type="checkbox"/> Clean | <input type="checkbox"/> Top Mount | EFFECT: (CHECK ONE) | | | | | <input type="checkbox"/> Comp/Echo | <input type="checkbox"/> Touch Wah |  |  |  |  |  | <input type="checkbox"/> Acoustic | <input type="checkbox"/> High Power | <input type="checkbox"/> Comp/Chorus | <input type="checkbox"/> Compressor |  |  |  |
| | <input type="checkbox"/> Blue Voodoo | <input type="checkbox"/> Studio Tweed | | | | | | <input type="checkbox"/> Cmp/Flg/Echo | <input type="checkbox"/> Tremolo | | | | | | | | | | | | |
| | <input type="checkbox"/> Vintage Club | <input type="checkbox"/> Black Face | | | | | | <input type="checkbox"/> Cmp/Cho/Echo | <input type="checkbox"/> Vibrato | | | | | | | | | | | | |
| | <input type="checkbox"/> Flexwave | <input type="checkbox"/> Large Tweed | | | | | | <input type="checkbox"/> Cmp/Vib/Echo | <input type="checkbox"/> Chorus | | | | | | | | | | | | |
| | <input type="checkbox"/> Ampeg VL | <input type="checkbox"/> 60s Era UK | | | | | | <input type="checkbox"/> Flange/Echo | <input type="checkbox"/> Flanger | | | | | | | | | | | | |
| | <input type="checkbox"/> Calif Mod | <input type="checkbox"/> 70s Era UK | | | | | | <input type="checkbox"/> Chor/Echo | <input type="checkbox"/> Delay | | | | | | | | | | | | |
| | <input type="checkbox"/> Tube Rectifier | <input type="checkbox"/> Fuzzbox | | | | | | <input type="checkbox"/> Rotating Spkr | <input type="checkbox"/> Echo | | | | | | | | | | | | |

DX-112/212 Digital Guitar Amplifier **CRATE**

USER PRESETS 96–100 - BANK B

Preset # 96 *I think I'll call it:* _____ Set TAP for _____ beats/minute

| | | |
|-----------------------------------|---|---------------------------------------|
| AMP MODEL: (CHECK ONE) | <input type="checkbox"/> Clean | <input type="checkbox"/> Top Mount |
| | <input type="checkbox"/> Acoustic | <input type="checkbox"/> High Power |
| | <input type="checkbox"/> Blue Voodoo | <input type="checkbox"/> Studio Tweed |
| | <input type="checkbox"/> Vintage Club | <input type="checkbox"/> Black Face |
| | <input type="checkbox"/> Flexwave | <input type="checkbox"/> Large Tweed |
| | <input type="checkbox"/> Ampeg VL | <input type="checkbox"/> 60s Era UK |
| | <input type="checkbox"/> Calif Mod | <input type="checkbox"/> 70s Era UK |
| | <input type="checkbox"/> Tube Rectifier | <input type="checkbox"/> Fuzzbox |

EFFECT: (CHECK ONE)

| | |
|--|-------------------------------------|
| <input type="checkbox"/> Comp/Echo | <input type="checkbox"/> Touch Wah |
| <input type="checkbox"/> Comp/Chorus | <input type="checkbox"/> Compressor |
| <input type="checkbox"/> Comp/Flg/Echo | <input type="checkbox"/> Tremolo |
| <input type="checkbox"/> Cmp/Cho/Echo | <input type="checkbox"/> Vibrato |
| <input type="checkbox"/> Cmp/Vib/Echo | <input type="checkbox"/> Chorus |
| <input type="checkbox"/> Flange/Echo | <input type="checkbox"/> Flanger |
| <input type="checkbox"/> Chor/Echo | <input type="checkbox"/> Delay |
| <input type="checkbox"/> Rotating Spkr | <input type="checkbox"/> Echo |



GAIN



BASS



MID



TREBLE



CHANNEL
LEVEL



EFFECT
ADJUST



REVERB
LEVEL



REVERB
DEPTH

Preset # 97 *I think I'll call it:* _____ Set TAP for _____ beats/minute

| | | |
|-----------------------------------|---|---------------------------------------|
| AMP MODEL: (CHECK ONE) | <input type="checkbox"/> Clean | <input type="checkbox"/> Top Mount |
| | <input type="checkbox"/> Acoustic | <input type="checkbox"/> High Power |
| | <input type="checkbox"/> Blue Voodoo | <input type="checkbox"/> Studio Tweed |
| | <input type="checkbox"/> Vintage Club | <input type="checkbox"/> Black Face |
| | <input type="checkbox"/> Flexwave | <input type="checkbox"/> Large Tweed |
| | <input type="checkbox"/> Ampeg VL | <input type="checkbox"/> 60s Era UK |
| | <input type="checkbox"/> Calif Mod | <input type="checkbox"/> 70s Era UK |
| | <input type="checkbox"/> Tube Rectifier | <input type="checkbox"/> Fuzzbox |

EFFECT: (CHECK ONE)

| | |
|--|-------------------------------------|
| <input type="checkbox"/> Comp/Echo | <input type="checkbox"/> Touch Wah |
| <input type="checkbox"/> Comp/Chorus | <input type="checkbox"/> Compressor |
| <input type="checkbox"/> Comp/Flg/Echo | <input type="checkbox"/> Tremolo |
| <input type="checkbox"/> Cmp/Cho/Echo | <input type="checkbox"/> Vibrato |
| <input type="checkbox"/> Cmp/Vib/Echo | <input type="checkbox"/> Chorus |
| <input type="checkbox"/> Flange/Echo | <input type="checkbox"/> Flanger |
| <input type="checkbox"/> Chor/Echo | <input type="checkbox"/> Delay |
| <input type="checkbox"/> Rotating Spkr | <input type="checkbox"/> Echo |



GAIN



BASS



MID



TREBLE



CHANNEL
LEVEL



EFFECT
ADJUST



REVERB
LEVEL



REVERB
DEPTH

Preset # 98 *I think I'll call it:* _____ Set TAP for _____ beats/minute

| | | |
|-----------------------------------|---|---------------------------------------|
| AMP MODEL: (CHECK ONE) | <input type="checkbox"/> Clean | <input type="checkbox"/> Top Mount |
| | <input type="checkbox"/> Acoustic | <input type="checkbox"/> High Power |
| | <input type="checkbox"/> Blue Voodoo | <input type="checkbox"/> Studio Tweed |
| | <input type="checkbox"/> Vintage Club | <input type="checkbox"/> Black Face |
| | <input type="checkbox"/> Flexwave | <input type="checkbox"/> Large Tweed |
| | <input type="checkbox"/> Ampeg VL | <input type="checkbox"/> 60s Era UK |
| | <input type="checkbox"/> Calif Mod | <input type="checkbox"/> 70s Era UK |
| | <input type="checkbox"/> Tube Rectifier | <input type="checkbox"/> Fuzzbox |

EFFECT: (CHECK ONE)

| | |
|--|-------------------------------------|
| <input type="checkbox"/> Comp/Echo | <input type="checkbox"/> Touch Wah |
| <input type="checkbox"/> Comp/Chorus | <input type="checkbox"/> Compressor |
| <input type="checkbox"/> Comp/Flg/Echo | <input type="checkbox"/> Tremolo |
| <input type="checkbox"/> Cmp/Cho/Echo | <input type="checkbox"/> Vibrato |
| <input type="checkbox"/> Cmp/Vib/Echo | <input type="checkbox"/> Chorus |
| <input type="checkbox"/> Flange/Echo | <input type="checkbox"/> Flanger |
| <input type="checkbox"/> Chor/Echo | <input type="checkbox"/> Delay |
| <input type="checkbox"/> Rotating Spkr | <input type="checkbox"/> Echo |



GAIN



BASS



MID



TREBLE



CHANNEL
LEVEL



EFFECT
ADJUST



REVERB
LEVEL



REVERB
DEPTH

Preset # 99 *I think I'll call it:* _____ Set TAP for _____ beats/minute

| | | |
|-----------------------------------|---|---------------------------------------|
| AMP MODEL: (CHECK ONE) | <input type="checkbox"/> Clean | <input type="checkbox"/> Top Mount |
| | <input type="checkbox"/> Acoustic | <input type="checkbox"/> High Power |
| | <input type="checkbox"/> Blue Voodoo | <input type="checkbox"/> Studio Tweed |
| | <input type="checkbox"/> Vintage Club | <input type="checkbox"/> Black Face |
| | <input type="checkbox"/> Flexwave | <input type="checkbox"/> Large Tweed |
| | <input type="checkbox"/> Ampeg VL | <input type="checkbox"/> 60s Era UK |
| | <input type="checkbox"/> Calif Mod | <input type="checkbox"/> 70s Era UK |
| | <input type="checkbox"/> Tube Rectifier | <input type="checkbox"/> Fuzzbox |

EFFECT: (CHECK ONE)

| | |
|--|-------------------------------------|
| <input type="checkbox"/> Comp/Echo | <input type="checkbox"/> Touch Wah |
| <input type="checkbox"/> Comp/Chorus | <input type="checkbox"/> Compressor |
| <input type="checkbox"/> Comp/Flg/Echo | <input type="checkbox"/> Tremolo |
| <input type="checkbox"/> Cmp/Cho/Echo | <input type="checkbox"/> Vibrato |
| <input type="checkbox"/> Cmp/Vib/Echo | <input type="checkbox"/> Chorus |
| <input type="checkbox"/> Flange/Echo | <input type="checkbox"/> Flanger |
| <input type="checkbox"/> Chor/Echo | <input type="checkbox"/> Delay |
| <input type="checkbox"/> Rotating Spkr | <input type="checkbox"/> Echo |



GAIN



BASS



MID



TREBLE



CHANNEL
LEVEL



EFFECT
ADJUST



REVERB
LEVEL



REVERB
DEPTH

Preset # 100 *I think I'll call it:* _____ Set TAP for _____ beats/minute

| | | |
|-----------------------------------|---|---------------------------------------|
| AMP MODEL: (CHECK ONE) | <input type="checkbox"/> Clean | <input type="checkbox"/> Top Mount |
| | <input type="checkbox"/> Acoustic | <input type="checkbox"/> High Power |
| | <input type="checkbox"/> Blue Voodoo | <input type="checkbox"/> Studio Tweed |
| | <input type="checkbox"/> Vintage Club | <input type="checkbox"/> Black Face |
| | <input type="checkbox"/> Flexwave | <input type="checkbox"/> Large Tweed |
| | <input type="checkbox"/> Ampeg VL | <input type="checkbox"/> 60s Era UK |
| | <input type="checkbox"/> Calif Mod | <input type="checkbox"/> 70s Era UK |
| | <input type="checkbox"/> Tube Rectifier | <input type="checkbox"/> Fuzzbox |

EFFECT: (CHECK ONE)

| | |
|--|-------------------------------------|
| <input type="checkbox"/> Comp/Echo | <input type="checkbox"/> Touch Wah |
| <input type="checkbox"/> Comp/Chorus | <input type="checkbox"/> Compressor |
| <input type="checkbox"/> Comp/Flg/Echo | <input type="checkbox"/> Tremolo |
| <input type="checkbox"/> Cmp/Cho/Echo | <input type="checkbox"/> Vibrato |
| <input type="checkbox"/> Cmp/Vib/Echo | <input type="checkbox"/> Chorus |
| <input type="checkbox"/> Flange/Echo | <input type="checkbox"/> Flanger |
| <input type="checkbox"/> Chor/Echo | <input type="checkbox"/> Delay |
| <input type="checkbox"/> Rotating Spkr | <input type="checkbox"/> Echo |



GAIN



BASS



MID



TREBLE



CHANNEL
LEVEL



EFFECT
ADJUST



REVERB
LEVEL



REVERB
DEPTH

Appendix A

Designer's Note: Amplifier Modeling:

Building an amplifier model is really not much different than building an actual amplifier. With an actual amplifier you start with components like tubes, transformers, resistors, capacitors, and a speaker, and put them together to create an amplifier. With a virtual amplifier you start with virtual components and put them together to create an amplifier model.

It all starts with what many consider to be the "magic" in the sound of many vintage amplifiers: the vacuum tube. We created a tube model flexible enough to emulate different types of vacuum tubes, from preamp tubes such as the 12AX7 to power amp tubes like the 6L6 and the EL84.

Next, we constructed models to duplicate the filtering and equalization that takes place between the gain stages of an amplifier. These equalization models are adaptable to precisely emulate the frequency characteristics of a specific amplifier's controls. We even created models for the output transformer and power supply sag characteristics.

After extensive research, we discovered that there's really no magic in the tube itself. Much of the tube amplifier sound is a result of not just the tube, but the way the tube interacts with the other components in the amplifier. We created our tube models to interact with the other components in our virtual amplifiers, just like the real thing.

After we developed our component models, we put them together to create our virtual amplifiers. We sound tested our amplifier models extensively to ensure that they remained true to the sound and feel of the original amplifier. Although we may have taken the magic out of the tube, we wanted to keep the magic of the tube *sound*.

The diagrams on the following page show the signal chain of the DX-112/212 amplifier.

DX-112/212 Digital Guitar Amplifier **CRATE**

Block Diagrams:

- The analog signal path, from the input jack to the speaker(s).

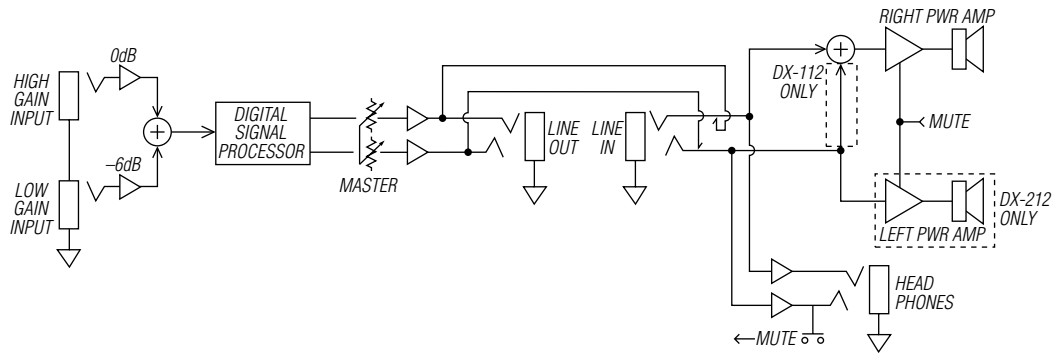

- The digital signal path, which is the path the signal takes inside the digital signal processor.

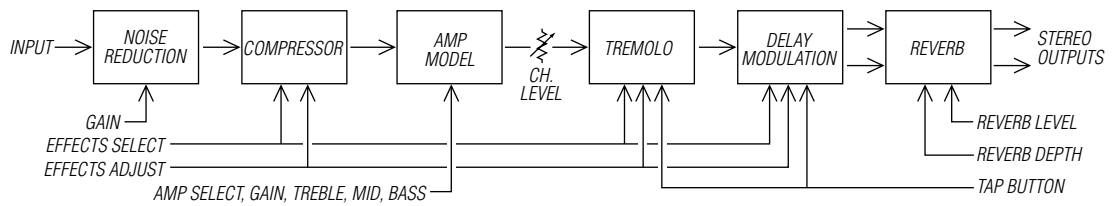

- A typical Amplifier Model. This simplified block diagram shows the digital signal path through the many virtual components of the Studio Tweed Amplifier Model. Note that the Fender Deluxe did not have a Mid or Bass control, so we added these controls post-gain.

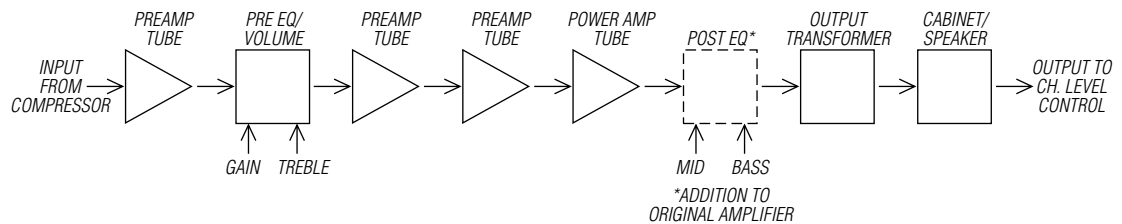

CRATE DX-112/212 Digital Guitar Amplifier

Appendix B

MIDI Implementation Chart:

[Crate Digital Guitar Amplifier]
MODEL DX-112/212

Date: 02/18/99
Version: 1.1

| Function | Transmitted | Recognized | Remarks |
|-------------------------|---------------|------------|---------|
| Basic Channel | Default | X | OMNI |
| | Changed | X | X |
| Mode | Default | X | Mode 1 |
| | Messages | X | X |
| | Altered | X | X |
| Note Number | | X | X |
| | True Voice | X | X |
| Velocity | Note ON | X | X |
| | Note OFF | X | X |
| After Touch | Key's | X | X |
| | Ch's | X | X |
| Pitch Bender | Default | X | X |
| Control Change | | X | X |
| | | X | X |
| Prog Change | | X | O |
| | True Number | X | X |
| System Exclusive | | X | 0 – 99 |
| System Common | Song Pos | X | X |
| | Song Sel | X | X |
| | Tune | X | X |
| System Real Time | Clock | X | X |
| | Commands | X | X |
| Aux Messages | Local ON/OFF | X | X |
| | All Notes Off | X | X |
| | Active Sense | X | X |
| | Reset | X | X |
| Notes | | | |

Mode 1: OMNI ON, POLY
Mode 3: OMNI OFF, POLY

Mode 2: OMNI ON, MONO
Mode 4: OMNI OFF, MONO

O: YES
X: NO

DX-112/212 Digital Guitar Amplifier

Appendix C

Specifications:

Analog:

| | |
|-----------------------|--|
| Output Power Rating | DX-112 60 watts RMS; DX-212 100 watts RMS (50W RMS x 2) |
| Input Impedance | High gain 80k ohm; Low gain 150k ohm |
| Line Input Impedance | 47k ohm |
| Line Output Impedance | 1k ohm |
| Headphone Impedance | 32 ohm minimum |
| Internal Speaker(s) | DX-112 (1) 12" Custom Eminence, 8 ohms; DX-212 (2) 12" Custom Eminence, 8 ohms |
| Power Requirements | 120VAC, 60Hz, 200VA; 100/115VAC, 50/60Hz, 200VA; 230VAC, 50/60Hz, 200VA |
| Size and Weight | DX-112/212 21.4"H x 27.9"W x 10.2"D; DX-112 50 lbs; DX-212 57 lbs |

Digital:

| | |
|------------------------------|---|
| Analog to Digital Conversion | 20-bit Delta-Sigma w/64X oversampling |
| Digital to Analog Conversion | 20-bit Delta-Sigma w/128X oversampling |
| Conversion Rate | 46.875 kHz |
| Digital Signal Processor | 24-bit operating at >40 million instructions/second |

Final Note:

No oversampling was used in our emulation software, and no animals were harmed during its design and development.



CRATE

www.crateamps.com

©1999 SLM Electronics, Inc. • A Division of St. Louis Music, Inc.
1400 Ferguson Avenue • St. Louis, MO 63133

47-825-02
02/99

Free Manuals Download Website

<http://myh66.com>

<http://usermanuals.us>

<http://www.somanuals.com>

<http://www.4manuals.cc>

<http://www.manual-lib.com>

<http://www.404manual.com>

<http://www.luxmanual.com>

<http://aubethermostatmanual.com>

Golf course search by state

<http://golfingnear.com>

Email search by domain

<http://emailbydomain.com>

Auto manuals search

<http://auto.somanuals.com>

TV manuals search

<http://tv.somanuals.com>