

CRATE

VTX30

**Two-Channel Guitar Amplifier
with Digital Signal Processing**



User's Guide

TABLE OF CONTENTS:

Introduction3
The Top Panel4,5
The Bottom Panel5
The DSP Section6
System Block Diagram7
Technical Specificationsback cover

This equipment has been tested and found to comply with the limits for a Class B digital device, pursuant to part 15 of the FCC Rules. These limits are designed to provide reasonable protection against harmful interference in a residential installation. This equipment generates, uses and can radiate radio frequency energy and, if not installed and used in accordance with the instructions, may cause harmful interference to radio communications. However, there is no guarantee that interference will not occur in a particular installation. If this equipment does cause harmful interference to radio or television reception, which can be determined by turning the equipment off and on, the user is encouraged to try to correct the interference by one or more of the following measures:

- Reorient or relocate the receiving antenna.
- Increase the separation between the equipment and the receiver.
- Connect the equipment into an outlet on a circuit different from that to which the receiver is connected.
- Consult the dealer or an experienced radio/TV technician for help.

Changes or modifications to this device not expressly approved by SLM Electronics could void the user's authority to operate the equipment under FCC rules.

Declaration of Conformity

Manufacturer's Name: SLM Electronics
Corporate Headquarters: 1901 Congressional Drive, St. Louis, Missouri 63146
Primary Production Facility: 700 Hwy 202 W, Yellville, Arkansas, 72687

Product Type: Audio Amplifier

Products meet the regulations for compliance marking under:







ETL standards UL6500, UL60065, or UL813
CSA standards E60065 or C22.2 No.1-M90
CE safety standard EN60065
CE EMC standards EN55103 or EN55013 and EN61000
C-tick designation Level 2, ABN #56748810738, ARBN# N222
KETI standard K60065 (limited model approval)

Compliance Support Contact: SLM Electronics, Attn: R&D Compliance Engineer
1901 Congressional Drive, St Louis, Missouri, 63146 • Tel.: 314-569-0141, Fax: 314-569-0175

Congratulations and thank you for choosing the Crate VTX30 Guitar Amplifier with Digital Signal Processing. This rugged amplifier features a Clean channel with a three-band EQ and level control, and a Solo channel with our patented FlexWave technology, Gain, Level and Shape control. An easy to operate DSP section lets you dial in a variety of digital effects including reverbs, delays, octave and wah-wahs. RCA input jacks allow connection of a CD or tape player for practicing with your favorite music, while the Headphones jack allows you to practice in private. The top-mounted electronic tuner allows you to get tuned and stay in tune any time the amplifier is on.

In order to get the most out of your new amplifier, we strongly urge you to read this guide before you begin playing.

And **thank you** for choosing **CRATE**.

 <p style="text-align: center;">CAUTION RISK OF ELECTRIC SHOCK DO NOT OPEN</p> <p style="font-size: 8px;">WARNING: TO REDUCE THE RISK OF FIRE OR ELECTRIC SHOCK, DO NOT EXPOSE THIS APPARATUS TO RAIN OR MOISTURE. TO REDUCE THE RISK OF ELECTRIC SHOCK, DO NOT REMOVE COVER. NO USER-SERVICEABLE PARTS INSIDE. REFER SERVICING TO QUALIFIED SERVICE PERSONNEL.</p>	 <p style="text-align: center;">PRECAUCION RIESGO DE CORRIENTAZO NO ABRA</p> <p style="font-size: 8px;">PRECAUCION: PARA REDUCIR EL RIESGO DE INCENDIOS O DESCARGAS ELECTRICAS, NO PERMITA QUE ESTE APARATO QUEDE EXPUESTO A LA LLUVIA O LA HUMEDAD. PARA DISMINUIR EL RIESGO DE CORRIENTAZO NO ABRA LA CUBIERTA. NO HAY PIEZAS ADENTRO QUE EL USUARIO PUEDO REPARAR DEJE TODO MANTENIMIENTO A LOS TECNICOS CALIFICADOS.</p>	 <p style="text-align: center;">ATTENTION RISQUE D'ELECTROCUTION NE PAS OUVRIR</p> <p style="font-size: 8px;">ATTENTION: PROTEGEZ CET APPAREIL DE LA PLUIE ET DE L'HUMIDITE AFIN D'EVITER TOUT RISQUE D'INCENDIE OU D'ELECTROCUTION. POUR REDUIRE D'ELECTROCUTION NE PAS ENLEVER LE COUVERCLE. AUCUNE PIECE INTERNE N'EST REPARABLE PAR L'UTILISATEUR. POUR TOUTE REPARATION, S'ADRESSER A UN TECHNICIEN QUALIFIE.</p>
<p>IMPORTANT SAFETY INSTRUCTIONS</p> <ul style="list-style-type: none"> • READ, FOLLOW, HEED, AND KEEP ALL INSTRUCTIONS AND WARNINGS. • DO NOT OPERATE NEAR ANY HEAT SOURCE AND DO NOT BLOCK ANY VENTILATION OPENINGS ON THIS APPARATUS. FOR PROPER OPERATION, THIS UNIT REQUIRES 3" (75mm) OF WELL VENTILATED SPACE AROUND HEATSINKS AND OTHER AIR FLOW PROVISIONS IN THE CABINET. • DO NOT USE THIS APPARATUS NEAR SPLASHING, FALLING, SPRAYING, OR STANDING LIQUIDS. • CLEAN ONLY WITH LINT-FREE DAMP CLOTH AND DO NOT USE CLEANING AGENTS. • ONLY CONNECT POWER CORD TO A POLARIZED, SAFETY GROUNDED OUTLET WIRED TO CURRENT ELECTRICAL CODES AND COMPATIBLE WITH VOLTAGE, POWER, AND FREQUENCY REQUIREMENTS STATED ON THE REAR PANEL OF THE APPARATUS. • PROTECT THE POWER CORD FROM DAMAGE DUE TO BEING WALKED ON, PINCHED, OR STRAINED. • UNPLUG THE APPARATUS DURING LIGHTNING STORMS OR WHEN UNUSED FOR LONG PERIODS OF TIME. • ONLY USE ATTACHMENTS, ACCESSORIES, STANDS, OR BRACKETS SPECIFIED BY THE MANUFACTURER FOR SAFE OPERATION AND TO AVOID INJURY. • WARNING: TO REDUCE THE RISK OF ELECTRIC SHOCK OR FIRE, DO NOT EXPOSE THIS UNIT TO RAIN OR MOISTURE.. • SERVICE MUST BE PERFORMED BY QUALIFIED PERSONNEL. • OUR AMPLIFIERS ARE CAPABLE OF PRODUCING HIGH SOUND PRESSURE LEVELS. CONTINUED EXPOSURE TO HIGH SOUND PRESSURE LEVELS CAN CAUSE PERMANENT HEARING IMPAIRMENT OR LOSS. USER CAUTION IS ADVISED AND EAR PROTECTION IS RECOMMENDED IF UNIT IS OPERATED AT HIGH VOLUME. 		
<p>EXPLANATION OF GRAPHICAL SYMBOLS:  = "DANGEROUS VOLTAGE" EXPLICACION DE SIMBOLOS GRAFICOS:  = "VOLTAJE PELIGROSO" EXPLICATION DES SYMBOLES GRAPHIQUES:  = "DANGER HAUTE TENSION"</p> <p style="text-align: right; font-size: 8px;">"IT IS NECESSARY FOR THE USER TO REFER TO THE INSTRUCTION MANUAL" "ES NECESARIO QUE EL USUARIO SE REFIERA AL MANUAL DE INSTRUCCIONES." "REFERREZ-VOUS AU MANUAL D'UTILISATION"</p>		

The Top Panel:

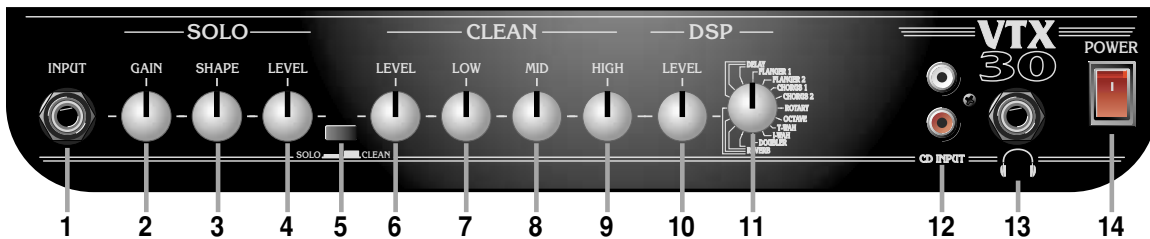

1: INPUT: Use this 1/4" jack to connect your guitar to the amplifier by means of a shielded instrument cable.

SOLO CHANNEL: A high gain channel giving you sounds from a slight edge to serious overdrive.

2: GAIN: Use this control to adjust the amount of distortion for the Solo channel.

3: SHAPE: Use this control to adjust the tone of the Solo channel.

4: LEVEL: Use this control to adjust the output level of the Solo channel.

5: SOLO/CLEAN: Use this switch to select the Solo or Clean channel. With the switch in the out position, the Clean channel is selected. When the switch is depressed, the Solo channel is selected.

CLEAN CHANNEL: A normal gain channel designed to give you crystal clear sounds to medium distortion.

6: LEVEL: Use this control to adjust the output level of the clean channel.

7: LOW: Use this control to adjust the low frequency level of the clean channel.

8: MID: Use this control to adjust the midrange frequency level of the clean channel.

9: HIGH: Use this control to adjust the high frequency level of the clean channel.

10: DSP LEVEL: Use this control to adjust the level of the selected digital effect. The DSP effects can be turned on and off by using a footswitch (#17, rear panel).

11: (DSP MODE): Use this control to select one of the 16 built-in digital effects. The nomenclature around the control is further explained in the chart on page 6.

12: CD INPUT: Use these RCA jacks to connect the output from a CD player or tape deck to the amplifier. The signal at these jacks is summed into a mono signal which is sent to the internal power amp circuit. Use the CD or tape player's output level control to adjust the signal for the proper mix with your guitar.

13: HEADPHONES: Use this jack to connect headphones to the amplifier. The internal speaker is disconnected when headphones are used.

CAUTION: To avoid possible damage to your hearing, do not use headphones for extended periods of time at extremely loud levels.

14: POWER: Use this switch to turn the amplifier on (top of the switch depressed) and off (bottom of the switch depressed). The switch illuminates when the amplifier is turned on.

15: TUNER: The electronic tuner is active whenever the amplifier is turned on, providing constant, “real-time” tuning. The bottom row of LEDs indicate which note (string) is being tuned. The top row of LEDs provides directional queues to facilitate quick and precise tuning of your instrument. The indicated note (string) is properly tuned when only the center LED is illuminated.

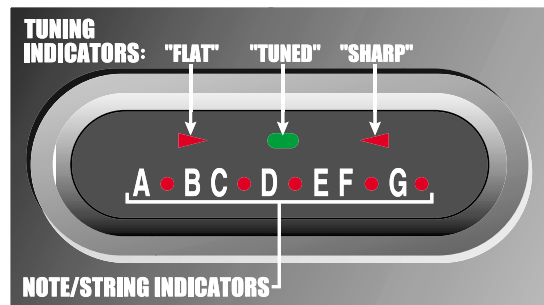

The Bottom Panel (not shown):

16: EXTENSION SPEAKER: Use this jack to connect the amplifier to an external speaker. The internal speaker is disconnected when this jack is used. The impedance of the external speaker must be 4 ohms or greater.

WARNING: Do not attempt to use headphones in the Speaker jack! Permanent hearing damage could result!

17: FOOTSWITCH: Use this jack to connect the 1/4” stereo plug on the cable of a two-button footswitch (such as the Crate CFP2). This allows you to remotely switch between the Clean and Solo channels and turn the DSP function on and off.

18: POWER CORD: The grounded power cord should only be plugged into a grounded power outlet that meets all applicable electrical codes and is compatible with the voltage, power, and frequency requirements stated on the bottom panel. **Do not attempt to defeat the safety ground connection.**

The DSP Section:

Use the DSP control to select one of the 16 built-in digital effects. Use the DSP Level control to adjust the amount of selected effect. In the fully counter clockwise position there will be no effect applied. As you rotate the Level control clockwise the amount of effect increases.

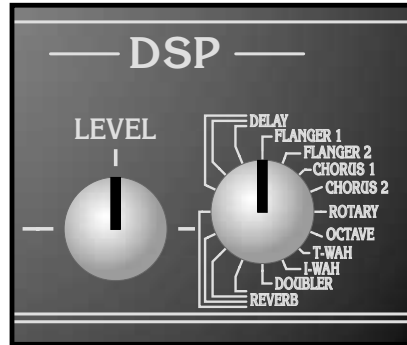

The chart below describes each of the 16 positions of the selector, starting at the 12:00 position and working clockwise.

- FLANGER 1:** slow deep flange w/reverb
- FLANGER 2:** flange w/reverb & delay
- CHORUS 1:** slow tremolo chorus w/reverb
- CHORUS 2:** chorus w/reverb & delay
- ROTARY:** rotating speaker effect
- OCTAVE:** adds signal one octave below
- T-WAH:** touch wah effect
- I-WAH:** inverse wah effect
- DOUBLER:** adds second signal slightly out of sync
- REVERB:**
 - small room reverb
 - medium room reverb
 - large room reverb
 - concert hall reverb
- DELAY:**
 - short slapback w/small room reverb
 - medium delay w/large room reverb
 - slow deep flange w/reverb

CRATE VTX30 Two-Channel Guitar Amplifier with DSP

System Block Diagram:

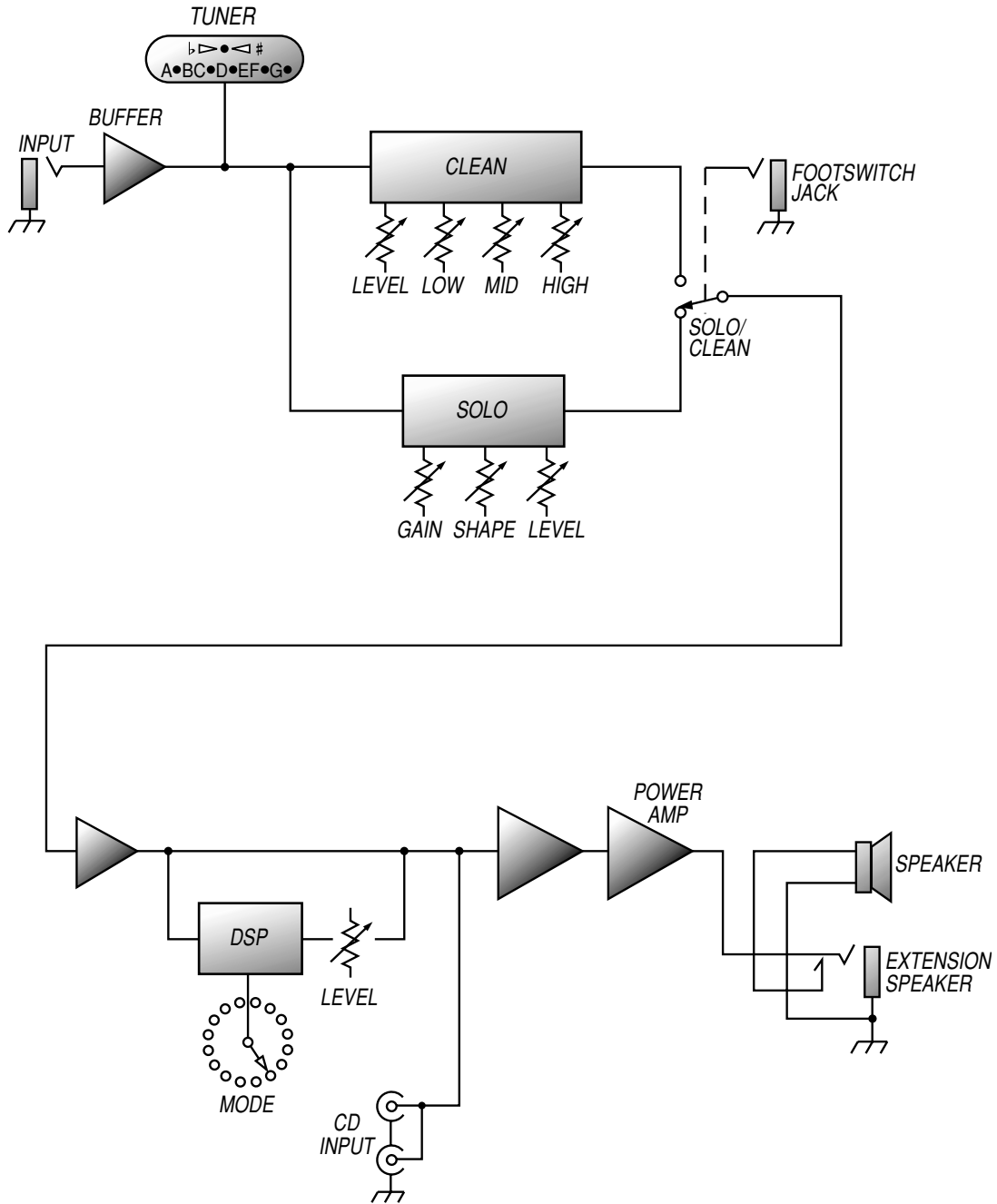

CRATE VTX30 Two-Channel Guitar Amplifier with DSP

VTX30 TECHNICAL SPECIFICATIONS:

Output Power Rating		>30W RMS @ 5% THD, 4Ω, 120 VAC
Gain	Solo Ch	98dB +/-6dB @ 1kHz
	Clean Ch	42dB +/-6dB @ 1kHz
Maximum Input Signal Accepted		6 volts peak-to-peak min. @ 1kHz
Tone Controls	Low	20dB range @ 80Hz
	Mid	12dB range @ 900Hz
	High	18dB range @ 10kHz
Speaker Size and Rating		10" Crate Custom Design 4 ohm
Power Requirements		120 VAC, 60Hz, 50VA
		100/115VAC, 50/60Hz, 50VA
		230VAC, 50/60Hz, 50VA
Size and Weight		16-1/2" H x 11-3/4" W x 9-1/4" D, 20 lbs.

The VTX30 is covered with a durable Tolex material: wipe it clean with a lint-free cloth. Never spray cleaning agents onto the cabinet. Avoid abrasive cleansers which would damage the finish.

Crate continually develops new products, as well as improves existing ones. For this reason, the specifications and information in this manual are subject to change without notice.

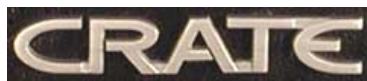

www.crateamps.com

@2004 SLM Electronics, a division of St. Louis Music, Inc • 1400 Ferguson Avenue • St. Louis, MO 63133
47-718-01 • 062104

Free Manuals Download Website

<http://myh66.com>

<http://usermanuals.us>

<http://www.somanuals.com>

<http://www.4manuals.cc>

<http://www.manual-lib.com>

<http://www.404manual.com>

<http://www.luxmanual.com>

<http://aubethermostatmanual.com>

Golf course search by state

<http://golfingnear.com>

Email search by domain

<http://emailbydomain.com>

Auto manuals search

<http://auto.somanuals.com>

TV manuals search

<http://tv.somanuals.com>