

The logo for Creda, featuring the brand name in a bold, white, sans-serif font set against a solid black rectangular background.

COOKER HOOD

USER HANDBOOK FOR INSTALLATION AND OPERATION MODEL CRV10

Your new Cooker Hood

Using your new Cooker Hood is very simple. Nevertheless, to get the best results it is important that you read this handbook thoroughly **before** installing and using your appliance for the first time.

Electrical Requirements

Any permanent electrical installation must comply with the latest I.E.E. Regulations and local electricity company regulations. For your own safety, this should be undertaken by a qualified electrician eg. your local electricity company or a contractor who is on the roll of the National Inspection Council for Electrical Installation Contracting (NICEIC).

Please ensure that when the appliance is installed it is easily accessible for the engineer in the event of a breakdown.

INCORRECT INSTALLATION COULD AFFECT THE SAFETY OF THE APPLIANCE

If the Cooker Hood is permanently wired in, it must be via a suitable double pole isolating switch placed in a readily accessible position adjacent to the unit.

Electrical Connection

Before connecting to the mains supply ensure that the mains voltage corresponds to the voltage on the rating plate, inside the Cooker Hood.

WARNING: THIS APPLIANCE MUST NOT BE EARTHED!

It is fitted with a 2 core mains supply cable and must be permanently connected to the electricity supply via a double pole switch having 3mm minimum contact gap on each pole. A Switched Fuse Connection Unit to BS 1363 Part 4, is a recommended mains supply connection accessory to ensure compliance with the Safety Requirements applicable to fixed wiring instructions.

DISCONNECT THE COOKER HOOD FROM THE MAINS SUPPLY BEFORE CARRYING OUT ANY KIND OF MAINTENANCE OR CLEANING.

**WARNING:
CHILDREN SHOULD NOT BE ALLOWED TO PLAY WITH THE APPLIANCE OR TAMPER WITH THE CONTROLS.**

CE CE marking certifies that this appliance conforms to the following EEC directives:-
Low Voltage Equipment - 72/23/EEC
Electromagnetic Compatibility - 89/336/EEC

Contents

	Page
Electrical Requirements	2
Get to know your Cooker Hood	4
Installing your Cooker Hood	
Installation for Recirculation	5-7
Installation for Extraction	
Mounting Height	
Fixing to the Cabinet	
Fixing to the Wall	
Operating your Cooker Hood	8
The Controls	
Do's and Don'ts	
Caring for your Cooker Hood	9-10
Filters and their Replacement	
Cleaning	
How to Replace the Light	
Troubleshooting	11
Key Contacts	Back Cover

Appliance manufactured in EU.

Retention of the Instruction Book

This Instruction Book must be kept handy for reference as it contains important details on the safe and proper use of the appliance.

If you sell or pass the appliance to someone else, or move house and leave it behind, make sure this Book is also provided so the new owner can become familiar with the appliance and safety warnings.

If the book is lost or damaged a copy may be obtained from:
GDA Ltd., Morley Way, Peterborough, PE2 9JB

Get to know your Cooker Hood.

Unpacking

Before installation, ensure that you have removed all packing pieces.

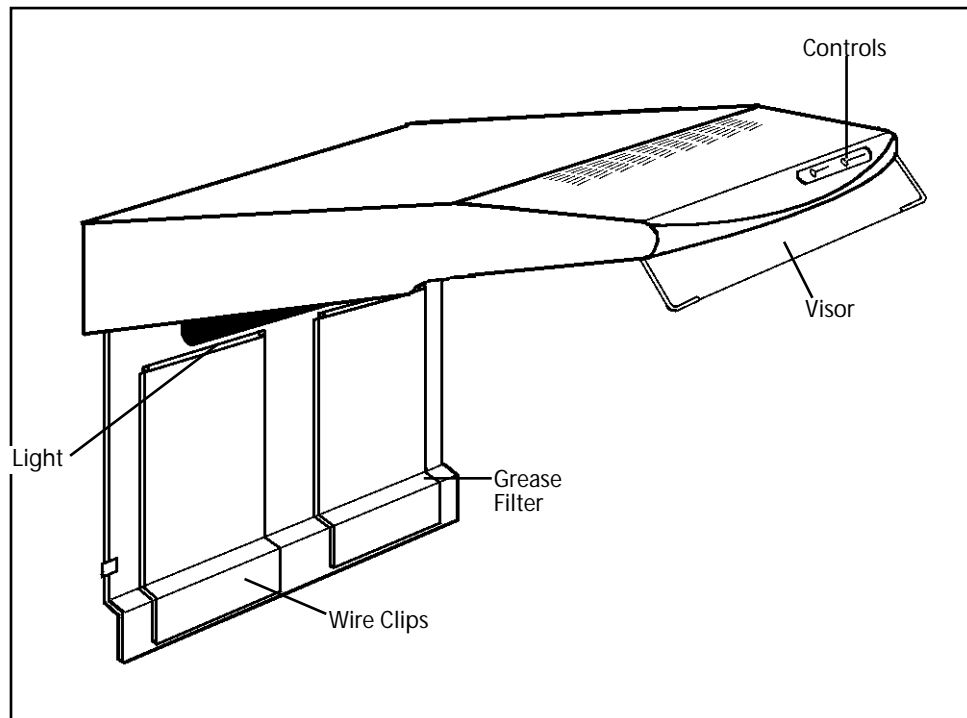

Dimensions

Height	15cm (5 ³ / ₄ in)
Width	60cm (23 ¹ / ₂ in)
Depth	55cm (21 ¹ / ₂ in)
Including visor.	

Installing your Cooker Hood

Your new Cooker Hood can be installed either for recirculation or extraction through an outside wall.

Installation:

These distances, between hobs and grease filter must be observed.

Minimum 65cm over an electric hob.
 Minimum 75cm over a gas hob.
 Minimum 40-45cm over a high level grill/top oven.

See page 7.

Installation for Recirculation:

If it is not possible to exhaust to the outside, the hood can be used to filter and recirculate the air (Fig.1).

Fig.1

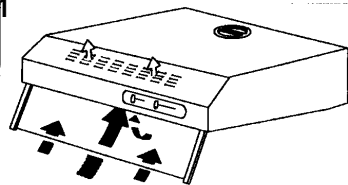

KEEP THIS AREA FREE FROM OBSTRUCTIONS

- To set deflector ready for extraction, slide the conversion control towards the outside of the conveyor until index C is visible (Fig.2a).
- To set deflector ready for recirculation, slide the control towards the inside of the conveyor (Fig.2b). Pull the plastic tongue that blocks the index C outwards, to make the insertion of the deflector easier. Fit the supplied cover on the upper outlet hole.

Fig.2

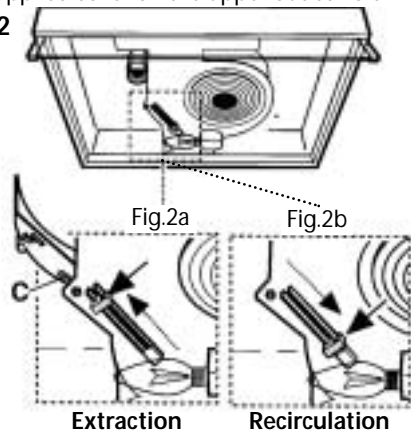

NOTE: The hood is more efficient in the exhaust mode, therefore this position should be selected during the warmer months of the year when no heating is being used. When the room is being heated, if the recirculation position is selected heat will not be wasted.

To obtain the best performance it is advisable to switch on the hood a few minutes before you start cooking and leave it running approximately 15 minutes after finishing.

Installation for Extraction:

Fig.3

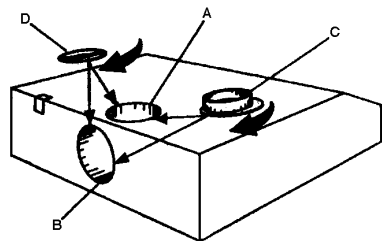

This method is recommended if at all possible. Fumes and grease laden air are drawn into the underside of the hood and expelled out.

The air can be expelled either upwards through a ventilating shaft (Fig.3 A) or directly through the wall to the outside (Fig.3 B). Ducting will be required if the Cooker Hood is mounted away from the outside vent. To connect the pipe, fit the coupling ring (Fig.3 C) in the selected outlet. Use the cover (Fig.3 D) to close the unused outlet.

IMPORTANT: The exhaust air must not be expelled through a smoke or waste-gas chimney which is in use or through a shaft used for ventilating rooms or into the cavity of a cavity wall.

If the room contains a flued fuel burning appliance, such as a gas or oil fired central heating boiler, which is not of the 'Balanced Flue' type, you should make sure that there is adequate air inlet into the room at all times so that fumes from the boiler are not drawn back into the room by the Cooker Hood.

NOTE: All installations must comply with local authorities and building regulation requirements for the discharge of exhaust air into the atmosphere.

Installing your Cooker Hood

Top Extraction (Fig.4)

Fig.4

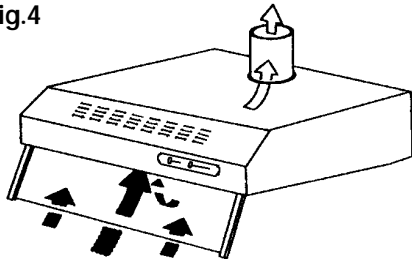

If the exhaust air is being drawn upwards, a pipe with a diameter of 100mm is necessary and the blanking plate must be fitted in the rear outlet. To check that the hood is set up for extraction, open the grille panel and make sure that the conversion lever on the unit is in the exhausting position.

Rear Extraction (Fig.5)

Fig.5

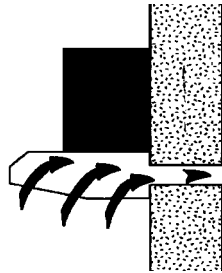

If the air is to be drawn off to the rear, a pipe with a diameter of 100mm is necessary and the blanking plate should be fitted in the top outlet.

Ducting:

In order to obtain satisfactory air extraction, long ducts should not be used. Pipes with a minimum internal diameter of 100mm and with as smooth an inner wall as possible are recommended. The ducting **MUST** be manufactured from a fire retardant material.

Installing your Cooker Hood

Wall Vent Kit:

For connecting the hood either directly through a wall or in conjunction with a ducting pipe, we recommend the use of a Wall Vent Kit. A 3m extension pipe is also available. Both of these are 100mm diameter and may be obtained from your nearest retailer or the Genuine Parts and Accessories Mail Order Hotline (see back cover) and must be used where there is a cavity wall.

MOUNTING

Mounting Height:

Your Cooker Hood is suitable for wall mounting or fixing to the underside of a wall cupboard. In either case the underneath of the hood should be 65cm above an electric hob, 75cm above a gas hob, 40-45cm above a high level grill/top oven. For the best results, the hood should be mounted as near as possible to the minimum recommended height.

WARNING: The fan motor of this appliance incorporates a thermal cut-out device which will operate if the hood is installed below the minimum recommended heights listed above, or if the motor becomes overheated. If the cut-out device is activated, switch off the fan motor and allow the hood to cool.

The cut-out device will reset itself when the fan motor has cooled significantly.

NOTE: This hood has been designed and approved for installation over an electric hob with a maximum input of 7kW or a gas hob with a maximum input of 10kW when fitted in accordance with the heights recommended above.

A template is enclosed for both wall and under-cupboard fixing.

Fixing to the cabinet:

Ensure that the cabinet is securely fixed to the wall, use 4 screws supplied (Fig.6) and proceed as follows:

Fig.6

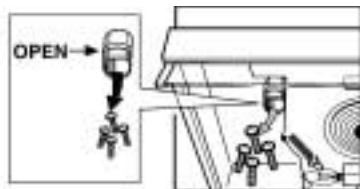

Make holes at the bottom of the cabinet using the template supplied. Fit the four 4.2 x 35mm screws supplied, in the holes, from inside the cabinet (Fig.7).

Fig.7

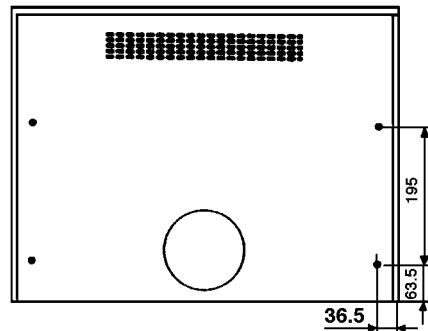

Fixing to the wall:

Fig.8

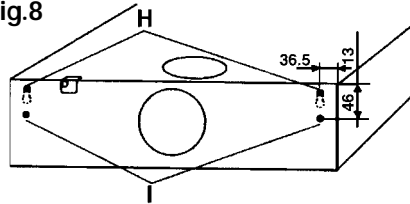

Fit the template to the wall.

Make four 8mm diameter holes in the wall, (2 on Fig.8 H and 1 on either of the points Fig.8 I).

Fit four 8mm wall plugs

Fit two 5mm diameter x 45mm long screws on H. Do not tighten completely.

Now hang the hood (holes H), tighten the two screws and fit the screws in hole I from inside the hood.

Operating your Cooker Hood

The Controls

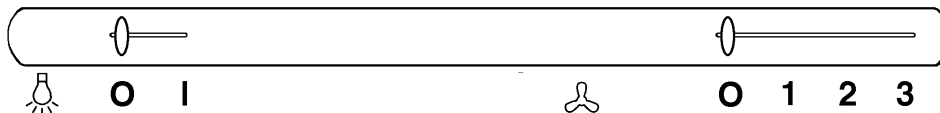

Make sure that the Cooker hood is wired in and the power supply is switched on. Your Cooker hood has three speeds, to give you the correct extraction level to suit your cooking conditions.

- 1 Low
- 2 Normal
- 3 Boost

The control marked with the symbol  controls the fan speed.

Position 1, should be selected when simmering or using only one pan.

Position 2 for normal cooking, up to four pans.

Position 3 when frying or cooking foods with strong odours.

Simply slide the selector to the required setting. It is advisable to leave it running for approximately 15 minutes after finishing cooking to ensure all odours are extracted. There is a separate selector for the light.

The switch marked with the symbol  controls illumination and indicates

when illumination is operating. 'O' is the OFF position. The visor can be adjusted to enlarge the extraction area.

Do's and Don'ts

DO

- Do** have the visor open when using the hob even if the fan on the hood is not switched on.
- Do** take extra care when frying.
- Do** keep the heating areas on your hob covered over with pots and pans etc. when using the hob and cooker hood simultaneously.
- Do** make sure that there is an adequate air inlet if you are venting externally and have a boiler or fire in the room, so that fumes are not drawn back from the flue.

DON'T

- Don't** use without the grease filter
- Don't** leave a naked flame under the hood.
- Don't** obstruct the recirculation grille on top of the hood (If using the hood for recirculation).
The area above the grille should be kept clear of obstruction for at least 150mm (6in) above the cooker hood.
- Don't** leave cooker/hob hotplates 'On' when not covered, as the fan motor of this cooker hood incorporates a thermal cut-out device which will operate if the hood overheats. The fan motor will take approximately 20 minutes to automatically reset at which point the hood will resume normal functions.
- NEVER** do flambé cooking beneath this cooker hood.
- NEVER** leave frying pans or deep fat fryers unattended during use, overheated fat/oil may catch fire.

Caring for your Cooker Hood

Before doing any cleaning or replacing the filters or light bulb, always ensure that the electricity supply to the Cooker Hood is switched 'OFF'.

Filters and their replacement:

THE GREASE FILTER -

Your Cooker Hood is fitted with a grease filter which absorbs grease, dust etc. and helps to keep the appliance clean inside. Gradually the filter will become saturated with grease and when this happens the visual indicator stripes will start to be seen through the filter grille. When the stripes are clearly visible from outside the Hood - the grease filter must be replaced.

IMPORTANT: There could be a possible fire hazard if the grease filter is not replaced when necessary and according to these instructions.

Replacement grease filters are available from your nearest retailer or our Genuine Parts and Accessories Mail Order Hotline (see back cover).

RELEASING THE GRILLE PANEL -

To open the grille panel press the catches into the centre of the grille. The grille will be released and will fall down, pivoting to the rear (Fig.9). Remove the metal filter retainer by pulling gently, to release it from the slot in the casing.

Fig.9

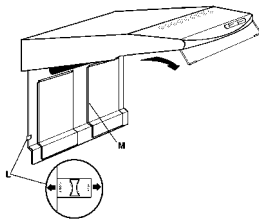

REPLACING THE GREASE FILTER -

1. Push the wire clips to one side and remove (Fig.10).

Fig.10

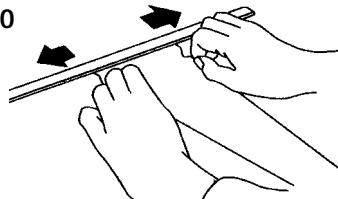

2. Remove the saturated grease filter.
3. Place the new grease filter in the filter grille (Fig.11).

Fig.11

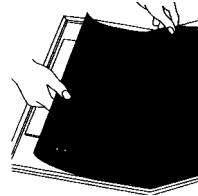

4. Replace the retaining clips.
5. Close the grille panel.

THE CARBON FILTER - (Recirculation only)

The activated carbon filter absorbs odours arising from the cooking. In use, the filter will slowly become saturated and gradually less effective. The filter will normally require changing every four months, depending on the amount and type of cooking you have done.

See page 5 (Figs. 1 and 2) to set your Cooker Hood to the recirculation option.

TO FIT THE CARBON FILTERS -

The deflector should be fixed to ensure the air flow is away from the wall to avoid dirtying or marking the rear wall (Fig.12).

Fig.12

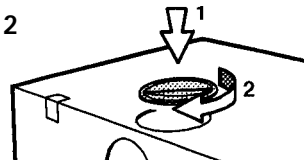

Place the new carbon filter, ensuring that it is aligned. To lock the filter turn in the direction of the arrow (Fig.13)

Fig.13

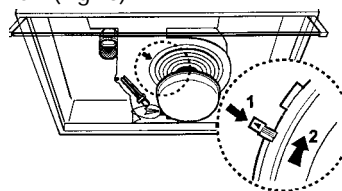

The Hood must not be connected to ducting when in the recirculating mode.

Regular replacement of the charcoal filter will ensure optimum performance from the hood when recirculating.

TO REPLACE THE CARBON FILTER -

Remove the grille by turning the locks and pull the grille out and downwards. Remove the saturated carbon filter by rotating it in an anti-clockwise direction and replace it with a new one.

Caring for your Cooker Hood

Cleaning:

The exterior of the Cooker Hood should be cleaned regularly to keep it looking like new. Wipe over with a soft cloth, wrung out in warm water and dry with a clean soft cloth. Wear protective gloves.

You can use mild non-abrasive cleaners but always read the manufacturer's instructions first. Always test their suitability on a small area of the Cooker Hood not noticeable in normal use.

NOTE: DO NOT use scouring pads or abrasive cleaners as they may scratch the surface.

How to replace the light:

Should the light fail to work, switch 'Off' the mains supply to the Hood.

Open the grille and check the bulb is screwed securely into the bulb holder then switch 'On' the mains supply.

If the light fails to work do not worry, it will not affect the working of your hood. Obtain a replacement 40 watt (E14) bulb. Switch 'Off' the mains supply. Unscrew the old bulb anti-clockwise to remove and replace with the new bulb turning clockwise until secure. Refit the filter grille and switch back 'On' at the mains.

NOTE: When changing the bulb, an identical replacement must be fitted to ensure the safe operation of the hood.

Fig.14



Troubleshooting.

First, don't panic!

There may be nothing wrong at all. Look for your problem below, then check the things we suggest. More often than not, this will give you the answer to your problem, and you'll be able to carry on without having to telephone your Service Office.

It is not working!

Are you using a plug and socket?

- Check that the plug is firmly pushed in.
- Check the power supply, by plugging in another appliance.
- Has the fuse blown?

It is not working!

Is the mains lead wired directly into a double pole isolating switch?

- Check that the wires in the mains lead are correctly connected. (See page 2)

The Cooker Hood is not working satisfactorily...

- Check you have selected the correct fan speed. (See page 8)
- Check you have left the cover over the recirculation grille on top of the Hood (extraction only), (See page 6).
- Check if the grease filter needs replacing (See page 9).

The light is not working...

- Check the bulb is screwed in securely.
- Replace the light bulb (See page 10)

The Cooker Hood switches off intermittently...

- Check the mounting height above the hob is correct (See page 5).
The heat from the hob may cause the fan motor to overheat/cut-out.

If, after following these instructions, you are still having problems, contact your nearest Service Centre (See back cover).

Parts

Please remember your new appliance is a complex piece of equipment.

Repairs may only be performed by qualified technicians. 'DIY' repairs or unqualified and untrained service people may put you in danger, could damage the appliance and might mean that you lose cover under the Guarantee.

If you do experience a problem with the appliance, don't take any risks, call in a Service Engineer (See back cover).

Our Parts are designed exclusively to fit only GDA Ltd appliances. Do not use them for any other purpose as you may create a safety hazard.

Key Contacts

Service

Creda has the largest appliance manufacturer's service team in Europe, trained specialists directly employed by us to ensure your complete confidence.

Repair Service

UK: 08709 066 066

Republic of Ireland: 1850 302 200

You will be asked for the following information:-

Name, address and postcode.

Telephone number

Model / Serial number of the appliance

Clear and concise details of the query or fault

Place and Date of purchase

(Please keep the receipt as evidence will be required when the engineer calls).

Extended Warranty

To join: UK 08709 088 088

Republic of Ireland: 1850 502 200

Genuine Parts & Accessories

Mail Order Hotline

UK: 08709 077 077

Republic of Ireland: (01) 842 6836

For further product information 08701 54 64 74

All Creda Services are offered as an extra benefit and do not affect your statutory rights.



General Domestic Appliances Limited, Morley Way, Peterborough, PE2 9JB

Part No. FP074-01

Free Manuals Download Website

<http://myh66.com>

<http://usermanuals.us>

<http://www.somanuals.com>

<http://www.4manuals.cc>

<http://www.manual-lib.com>

<http://www.404manual.com>

<http://www.luxmanual.com>

<http://aubethermostatmanual.com>

Golf course search by state

<http://golfingnear.com>

Email search by domain

<http://emailbydomain.com>

Auto manuals search

<http://auto.somanuals.com>

TV manuals search

<http://tv.somanuals.com>