

Models 17306/17307/17316/17317

How to get the best out of your Creda Washer/Dryer

It is essential that you read through this
Instruction book carefully before your first wash and/or dry
and retain it for future reference.

Creda Washer/Dryer L & SDL

This instruction book applies to the following models:

Creda Washer/Dryer L (17306 Brown – 17316 White)

Creda Washer/Dryer SDL (17307 Brown – 17317 White)
With Programme Start Delay

Any difference between the models are clearly indicated.

Now that you are the owner of a Creda Automatic Washer/Dryer it is important that you read this book carefully. This book will tell you how to get the best from your new Creda Washer/Dryer and ensure that you always obtain the cleanest, freshest wash and/or dry possible. You must read it through carefully before your first wash and/or dry.

IMPORTANT

TO PROTECT YOUR NEW WASHER/DRYER DURING TRANSIT SEVERAL INTERNAL COMPONENTS HAVE BEEN SECURED WITH TRANSIT PACKING. THIS PACKING MUST BE REMOVED BEFORE USING THE MACHINE.

FOR UNPACKING, INSTALLATION AND PLUMBING, PLEASE SEE THE ADDITIONAL INSTALLATION INSTRUCTION SHEET.

NEVER REMOVE THE REAR PANEL WHILST THE MACHINE IS PLUGGED INTO THE ELECTRICITY SUPPLY.

AS WITH ANY ELECTRICAL PRODUCT, CHILDREN MUST NOT BE ALLOWED TO PLAY WITH OR OTHERWISE INTERFERE WITH THE WASHER/DRYER.

YOU MUST READ THESE INSTRUCTIONS PRIOR TO USING THE APPLIANCE AND RETAIN THEM FOR FUTURE REFERENCE.

WHEN THE MACHINE IS NOT IN USE, SWITCH OFF AT THE WALL SOCKET, REMOVE THE PLUG, TURN OFF THE WATER AND CLOSE THE DOOR.



Creda Limited
PO Box 5, Creda Works
Blythe Bridge, Stoke-on-Trent
England. ST11 9LJ
Telephone: 0782 388388

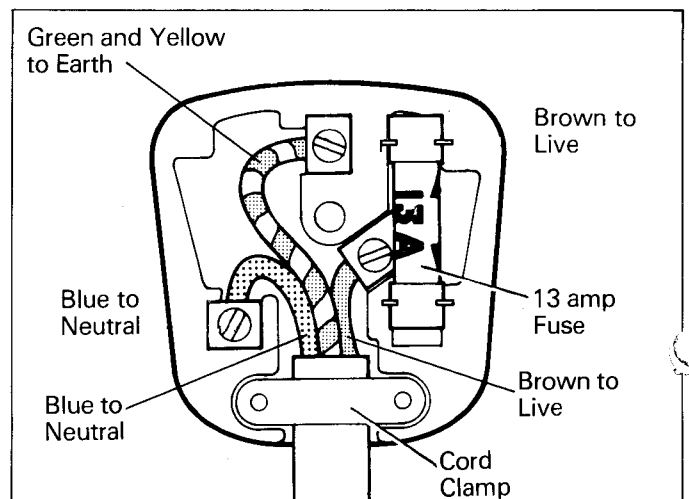

Contents

Electrical Requirements	3
Know Your Machine	4
Controls	4-5
Detergent Dispenser	5
Tumble Drying	5-6
Using the Tumble Dryer	6-7
To Carry Out a Simple Wash/Dry	7
Variations on a Simple Wash/Dry	8
Detergents, Conditioners, Water Hardness	9
Wash Codes Programme Guide	10-11
Stain Removal	12
Care and Cleaning	12
Checking Water Pressures	13
Regular Checks	13
Something Wrong With Your Machine	14
CredaCare Your Guarantee	15
After Sales Service/Spare Parts	15

Electrical Requirements

WARNING – THIS APPLIANCE MUST BE EARTHED. REFER TO RATING PLATE FOR VOLTAGE.

The flexible mains lead must be correctly connected as below to a 3 pin plug of not less than 13amp capacity. If a BS.1363 fused plug is used it must be fitted with a 13 amp fuse which is approved to BS.1362.

We recommend the use of good quality plugs and wall sockets that can be switched off when the machine is not in use.

IMPORTANT: The wires in the mains lead fitted to this appliance are coloured in accordance with the following code:

GREEN AND YELLOW	— EARTH
BLUE	— NEUTRAL
BROWN	— LIVE

If the colours of the wires in the mains lead of this appliance may not correspond with the coloured markings identifying the terminals in your plug, proceed as follows:

The wire which is coloured green and yellow must be connected to the terminal in the plug which is marked with the letter E or by the earth symbol \perp or coloured green or

green and yellow. The wire which is coloured blue must be connected to the terminal which is marked with the letter N or coloured black or blue. The wire which is coloured brown must be connected to the terminal which is marked with the letter L or coloured red or brown.

When wiring the plug, ensure that all strands of wire are securely retained in each terminal. Do not forget to tighten the mains lead clamp on the plug. If your electricity supply point has only two pin socket outlets, **or if you are in doubt, consult a qualified electrician.** Should the mains lead ever require replacement, it is essential that this operation is carried out by a qualified electrician and should only be replaced with a flexible cord of the same size i.e., 1.25mm².

Note: Socket outlets are not permitted in bathrooms, neither should any provision be made for connecting moveable electrical appliances. No stationary appliance is to be installed within reach of a person using the bath or shower.

This appliance conforms to BS. 800: 1983 and EEC directive 82/499 regarding suppression of radio and television reception interference.

Know Your Machine

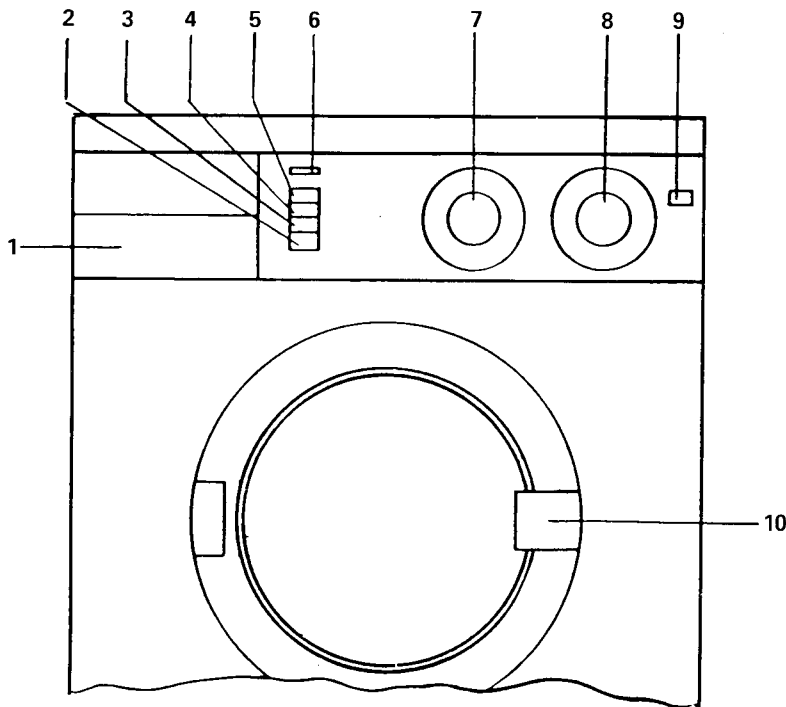

Washer/Dryer L

- 1 Detergent dispenser
- 2 Fast Wash Switch
- 3 Slow Spin Switch
- 4 Crease Care Switch
- 5 Half Load Switch
- 6 Power Indicator Light
- 7 Drying Time Selector
- 8 Programme Selector
- 9 Power Switch
- 10 Door handle

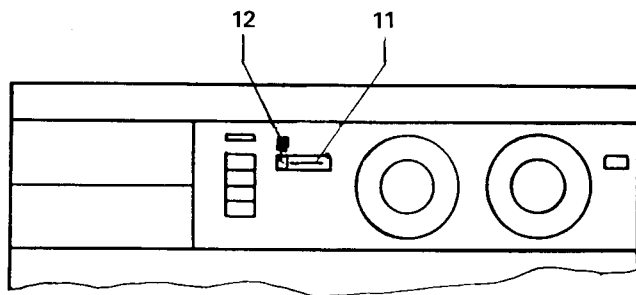

Washer/Dryer SDL

- 1-10 as above
- 11 Programme Delay Selector
- 12 Programme Delay Indicator Light

Controls

Power Switch

To switch the machine on, press **IN** the power switch firmly.

Power Indicator Light

This light will glow when the machine is switched on i.e., the power switch is pressed in and the machine is connected to the electricity supply at the wall socket.

Door

Pull the door handle to open the door.

At the end of a programme a short time delay device will prevent the door from being opened immediately.

If you wish to gain access. Press **In** the programme selector knob. After the time delay has elapsed the door can be opened.

THE DOOR SHOULD NEVER BE OPENED WHEN THE WATER LEVEL IS VISIBLE IN THE DOOR WINDOW.

Programme Selector

This is operated by firmly pressing in the centre of the selector knob which will come out enabling you to select a programme.

The selector is marked with the following symbols:

- Auto Prewash
- Wash Programme
- Long Spin
- Short Spin
- Off/High Heat Dry (Cottons)
- Off/Gentle Heat Dry (Synthetics)

The selector is divided into two sections marked for programmes 1, 2 and 5 and for programmes 3, 4, 6 and 7. The numbered washes are to the International Textile Care Label (ITCL) specifications.

The selector also includes an Auto Prewash programme and can be set for Rinse and Spin, Spin only and Dry only programmes.

To start any wash, wash/dry or dry only programme with or without a delay period the selector must be pulled fully out. The whole knob assembly will move out and the machine will start operating after a few seconds delay.

The selector must only be turned clockwise and must not be turned when pulled out.

Programmes 1, 2 and 5 will finish in the stop/dry position marked and programmes 3, 4, 6 and 7 will finish in the stop/dry position marked .

Controls

Drying Time Selector

This is also operated by firmly pressing in the centre of the selector knob which will come out enabling you to select a drying time.

Your machine is fully automatic. On completion of all wash programmes the washing will be automatically tumble dried if a time has been selected on the Drying Time Selector.

The selector is marked between 0 and 90 minutes and includes a period of cool tumble at the end of the drying cycle.

The selector may be turned clockwise or anti-clockwise between the 0 and 90 minute positions, but you must **NEVER ATTEMPT TO MOVE THE TIMER EITHER CLOCKWISE THROUGH THE 90 MINUTE POSITION OR BACK ANTI-CLOCKWISE THROUGH THE 0 POSITION AS THIS MAY CAUSE DAMAGE TO THE TIMER.** This selector does not pull out like the programme selector. To start any programme even when just drying, it is only necessary to pull out the programme selector.

Option Switches

The option switches allow you to vary the content of the wash programme. They do not affect drying.

To select an option press the switch **IN**

To cancel an option press the switch **OUT**

Half Load Switch

The most economical way to use the machine is to wash full loads of garments to get the most efficient use of water, powder and electricity. When washing small loads the half load switch can be used and less detergent may be used. When selected the half load switch reduces the quantity of water used for both washing and rinsing. The switch should only be used for small loads and must never be used with Programme 7, as Woollens require full water quantities.

Crease Care Switch

When selected the machine will stop with the clothes immersed and suspended in the final rinse water. This is essential when washing delicate or synthetic articles if they are going to be left in the drum for a long time after the wash programme is completed and a drying time has not been selected in order to prevent the garments becoming heavily creased.

To start the machine again for the finishing spin and tumble dry if selected, simply press **out** the switch. The pump will start followed by the drum revolving to distribute the clothing for spin.

Slow Spin Switch

When selected it reduces the final spin speed from 1150 rpm to 600 rpm. Unless selected, the machine will always spin at the faster spin speed.

It should always be used on programme **[6]** or permanent creasing may result. On programme **[3]** and **[4]** it should be used if you do not intend to tumble dry and you wish to minimise creasing.

Fast Wash Switch

When selected it shortens the programme time. This is particularly useful where time is important and the garments are only lightly soiled.

The results obtained using this option may not be up to the standard of normal full wash programmes.

It has no effect on Auto Prewash and Spin only programmes.

Programme Delay Selector

(Washer/Dryer SDL Models Only)

A programme start delay is selected by moving the slider to the required time (marked in hours). When selected this will delay the start of any programme by the time indicated. During the delay period the delay indicator light above the selector will light to show a delay is in operation. The slider will remain stationary in the position set.

If a delay period is not required you must ensure that the slider control is pushed to the option switch end of the slide underneath the delay indicator light. Always return the slider to this position after the cycle is complete.

Detergent Dispenser

Press in the flap at the bottom of the detergent dispenser front to enable you to pull out the dispenser. The dispenser has three compartments, two for detergent and one for fabric conditioner.

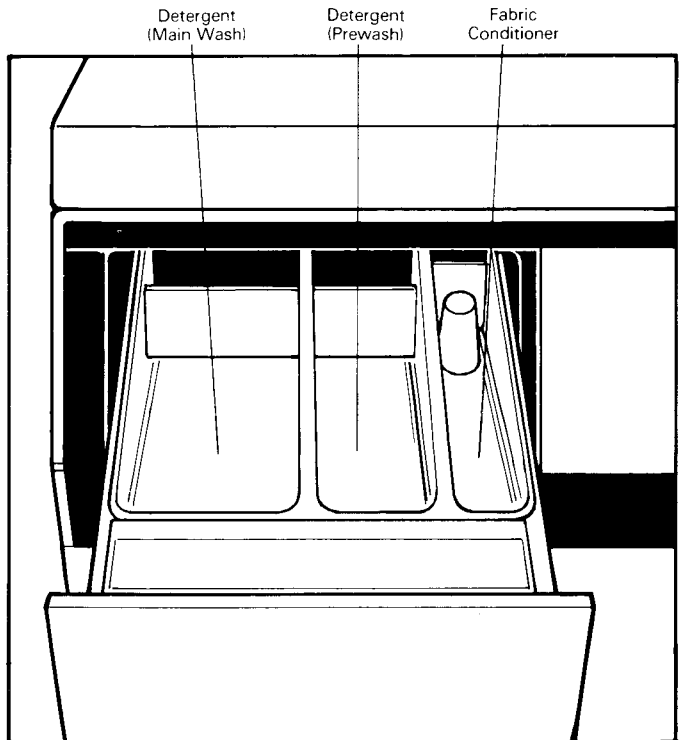

NOTE: When fabric conditioner is added, the compartment **must not** be overfilled. To avoid clogging, detergent **must not** be allowed to get into the fabric conditioner compartment. **Do not** pull out the drawer when the machine is filling

Tumble Drying

Introduction

A tumble dryer gently tumbles the wet clothes in a current of warm air after they have been spun. Moisture is evaporated until the clothes are quite dry, much like what takes place outdoors in a fresh breeze on a fine sunny day, in a clean fresh atmosphere.

But a good tumble dryer can do much more than this.

A good tumble dryer reduces unwanted creases as it dries, creases that may have been put in during spinning.

Many fabrics used in the manufacture of clothing and household textiles tend to undergo some changes of size when laundered. This size change is due to relaxation of the fibres, which have been stretched during spinning and

Tumble Drying

weaving, and which tend to return to their unstretched state when immersed in water. These fibres normally stretch again in use, and even hanging wet on a line stretches the material to some extent. Tumble drying does not put any tension on the fabric as line drying does, and the difference may therefore appear more noticeable when the garments are dry.

During drying the moisture evaporated out of the clothes is condensed out of the circulating air using cold water from the mains. The water is then pumped away to drain.

Cautionary Notes

Flammable Substances:

The machine will only tumble dry articles that have been well washed in water and detergent and well rinsed and spun. Never dry articles that are contaminated with flammable substances such as:

Petrol, Oil, Paint Hair Lacquer, Creams
Cleaning Solvents, Wax Cooking Fat or Oil.

For the same reason you must not tumble dry

Rubber, Foam Rubber, Plastic, Plastic Foam
Nappy Pants and Liners
Polythene and Paper
Any garments that have been dry cleaned.

Wool

Woollen articles should not be dried in the dryer unless they are labelled 'Superwash', 'Machine-washable' or have the 'May be tumble dried' symbol. If in any doubt do not tumble dry wool. Unlike other materials, the mechanism of wool shrinkage is irreversible, i.e. it will not stretch back to its original size and shape.

Maximum Loads – Dry Weights

The maximum load for tumble drying varies according to the type of material, but is in general **approximately half the recommended maximum wash load**. These are all dry weights. You must follow the recommendations given in the Drying Chart.

When the machine has come to rest after the final spin, any excess of clothes must be removed and the remainder re-distributed to enable them to tumble freely. If necessary the clothes must also be sorted according to fabric as indicated in the Drying Chart. **Do not overload.**

Cool Tumble Period

Before clothes stop tumbling the heater will automatically switch off and the clothes will continue to tumble for up to 10 minutes in cool air. This cool tumble period is essential for all fabrics – to reduce the temperature of the load and to reduce creasing.

Always use the cool cycle to cool the load down before removing garments from the drum. **Never switch the machine off leaving a hot load in the drum.**

What can be Tumble Dried

The following symbols may be found on the care labels of garments: –

 indicates article may be tumble dried

 indicates article must not be tumble dried.

Notes:

Never tumble dry dripping wet garments, always spin them first.

Large very bulky items such as continental quilts and pillows should not be dried as it is essential that the load can tumble so that the air can pass through to dry items.

Articles that contain safety pins, hair grips, metal fastenings or stiffening (e.g. bra wires) that may become detached should not be placed in laundry appliances. If they tumble free they could interfere with mechanical or electrical parts of your washer/dryer.

Using the Tumble Dryer

Your machine may be used either to automatically tumble dry after a wash cycle or to tumble dry only. The cold water supply to your machine must be turned on before you use the tumble dryer.

As a general guide the Drying Chart gives recommended information for various materials.

Before Tumbling

Please Read the Cautionary Notes.

It is very important to follow carefully each garment manufacturer's washing and drying instruction, as given on the Care Label attached to the garment.

Fabric Conditioner added to the final rinse will give even more softness to all fabrics and is invaluable for reducing the static electricity which causes easy-care fabrics to cling and attract dirt.

Making up Loads

Clothes should be sorted into loads of similar fabrics before drying. Cotton which needs ironing can be dried to a suitable dampness. Towels and other cotton items which do not need ironing can be fully dried and these will be ready to wear or store as soon as they are taken from the dryer.

Heavy fabrics should be dried separately from lightweight fabrics.

Loose belts, apron strings etc. should be tied and zip fasteners fully closed before being placed in the washer/dryer.

Selecting the Drying Programme

If you do not rinse and spin before drying you will need to select the correct heat setting on the Programme Selector. Two settings are available, one for natural fabrics and one for synthetics. These are identified as follows:

☼ Full Heat Drying – Cotton Fabrics
ITCL Codes 1, 2 & 5

☽ Gentle Heating Drying – Synthetic Fabrics
ITCL Codes 3, 4 & 6

Selecting Drying Times

This will depend on the size of the load, the type of fabric and the wetness of the load. It is therefore not possible to give an exact drying time but experience will quickly enable you to set the appropriate time for fully drying or damp drying to your requirements.

If you are not sure how long a load will take to dry, see page 11 under 'Drying'. As a general guide the Drying Chart gives recommended information for various materials.

Drying Chart

Fabric	Type of Load	Recommended Max. Load	Prog. Selector Setting
Cottons and linens	Variety of items varying in sizes Ideally not all towels and sheets	2.3kg 5 lbs	☼
	All towels. For heavy bath towels – reduce the load	1.8kg 4 lbs	☼
Polyester/cotton and Terylene/cotton	Bed linen and/or shirts	1.8kg 4 lbs	☽
Synthetic fibres, Crimplene, Orlon, Acrilan, Courtelle etc.	Variety of items, nightwear jumpers, socks, cardigans	1.8kg 4 lbs	☽
Synthetic fibres, nylon, Celon, etc.	Variety of lightweight items, bed linen, nightwear, shirts	1.8kg 4 lbs	☽

Using the Tumble Dryer (Continued)

Energy Control

Your washer/dryer has an automatic energy saving feature which reduces the amount of heat supplied to the clothes once they are dry. This reduces the wastage of electricity when drying times are set too long.

To Carry Out a Simple Wash/Dry

e.g. Coloured Cotton





- 1) If the machine is **not** plumbed in remember you must first hook the drain hose into the standpipe or over the sink, ensuring that the sink plug has been removed and the sink grille is clear. Connect the red inlet hose to your hot water supply and the blue hose to the cold supply and turn the taps on. **Do not** use your sink for other purposes at the same time as your washer/dryer is in use, as the discharge water could be very hot. Ensure the washer/dryer is located where air can freely circulate.
- 2) Ensure that your 13 amp plug from the machine is plugged in and power is switched on at the main socket. Make sure that the power is switched **On** (Power Indicator Light **On**).
- 3) Sort the clothes into batches and select items marked 2/60°C. Always ensure that pockets are emptied and it is advisable to loosely tie apron and pyjama strings and do up zips. Badly soiled or stained clothes should be specially treated **before** the washing section of the cycle.
- 4) On this programme the drum of your machine will take up to a maximum load of 4.5kg (10lbs) dry weight, if you intend just to wash. If you intend to wash and dry automatically **do not exceed** 2.3kg (5lbs) dry weight. Pull the door catch lever to open the door, and load the machine. Clothes should be placed into the drum separately. Then close the door.
- 5) If your water is of average hardness and you are washing a full load of clothes, add two cupfuls of detergent to the main wash compartment in the detergent dispenser. To do this pull the dispenser drawer out as far as possible and add the detergent. Then add fabric conditioner, in line with the instructions given on the bottle, to the fabric conditioner compartment of the dispenser. Ensure that the dispenser drawer is fully closed as otherwise leaks will occur. Only detergent suitable for front loading automatic machines should be used.
- 6) Ensure all option switches are off (**Out**). On machines fitted with a programme start delay ensure that the slider control is pushed to the option switch end of the slide underneath the delay indicator light.
- 7) Press in the centre of Programme Selector to release it. Set it to Position 2 by turning clockwise only. Similarly press in the centre of the Drying Time Selector to release it and set it to the required drying time by turning between the 0 and 90 minute positions only. Should a drying period not be required, ensure that the Drying Time Selector is set to the 0 position. See page 11 under drying for a guide to what drying time is required.
- 8) Pull the Programme Selector fully out to start the programme. Check that there is no start delay selected (delay indicator light out). The machine will now commence the wash cycle. After completion of the wash cycle if no drying time has been set the machine will stop with the Programme Selector in position . Push in the Programme Selector and the clothes may be removed. If a drying time has been selected, then drying will automatically commence. After completion of the drying cycle which will end with a period of tumbling in cool air, the machine will stop with the Drying Time Selector at 0.
- 9) Press the Programme Selector in and pull the door catch lever to open the door. After removing the clothes, press out the power switch, switch off the electricity at the wall switch and turn off the water taps.
- 10) After completing your initial wash and dry you can now proceed to successfully follow any of the other main wash or dry programmes with complete confidence and knowledge of your machine.

Variations on a Simple Wash/Dry

Washing

Auto Prewash

Prewash is available automatically with Programme 1. If you have heavily-soiled items to wash and wish to prewash, first merely select  position on the programme selector. The machine will give a low temperature prewash and then automatically go on to the main wash programme without any further input from you.

If you require a prewash for other than main wash programme 1, first select the prewash position . At the end of the prewash cycle after the machine has pumped out the prewash water but before it has filled for the main wash, press in the Programme Selector, then move it on to the required programme. Care must be taken to ensure that the machine is not allowed to proceed into mainwash. Finally, pull the Programme Selector out. The machine will carry on washing.



Note: Items soiled with oil, fat, greases (i.e. vaseline) or metallic compounds should always be given a prewash before the main wash as such deposits can cause deterioration of the door seal.

Using the Machine to Rinse and Spin

The type of rinsing and spinning can be varied according to the position selected. For hard-wearing materials the rinse section following programmes 1, 2 and 5 should be selected, for delicate materials the rinse section following programme 6, 7 will give optimum results. The machine will automatically go into spin after the rinsing cycle is complete. Fast or slow spin may be selected using the Slow Spin Switch (see page 5). Tumble drying will then proceed automatically if a timed period has been selected on the Drying Time Selector.

Using the Machine to Spin Only

Select either of the spin positions marked on the Programme Selector.

-  Short spin should be selected for delicate materials.
-  Long spin for other materials.

Tumble drying will then proceed automatically if a timed period has been set on the Drying Time Selector.

Rhythm Spin

When Long Spin  is selected the cycle includes a number of progressively faster spins with reverse tumbling in between and followed by a long full speed spin. This will ensure that after spin your clothes are lying loosely in the drum and ready for drying.

Drying

Using the Machine to Dry Only

The cold water supply to your machine must be turned on before you use the tumble dryer. (And off again after use).

Where you have not been able to dry a full load of washing, or where you wish to dry certain articles washed by hand, it may be necessary to select a drying cycle independently.

If you are not sure how long a load will take to dry, set the Drying Time Selector to the 90 minute position. Set the Programme Selector to the correct drying programme (see page 6) and pull it fully out. The machine will start to tumble dry. Part way through the cycle, press in the Programme Selector. The machine will stop tumbling. Move the Drying Time Selector to the cool tumble period. Pull the Programme Selector out and allow the machine to run for a few minutes. This will cool the load in the dryer. Finally press in the Programme Selector and open the door. Check whether the load or part of it is dry.

If you select short drying times, the load may not be dry and it may be necessary to re-set the selector. This method will prolong drying times due to the repeated inclusion of the cooling down period and the subsequent re-heating of the load when the dryer is re-set. You will quickly find how long different loads take to dry.

Also refer to page 6 'Using the Tumble Dryer'.

Programme Start Delay

(Washer/Dryer SDL only)

Using the Programme Start Delay

If you wish to delay the start of the programme for use on Economy 7/White Meter tariff where available, first set the Programme Selector and the Drying Time Selector to the programme required. Also select any option's required. Then set the Programme Delay Selector to the required delay time (indicated in hours).

When you pull out the Programme Selector the delay period will commence (delay indicator light on). When the delay period has finished (delay indicator light off) the machine will commence the selected wash/dry cycle.

When using the Programme Start Delay for washing only we recommend the selection of the Crease Care option (see page 5) to eliminate unnecessary creasing.

To cancel a delay period just slide the control back to the option switch end of the slide underneath the indicator light. The light will go out and the machine will start the programme selected.

To change the delay period at any time press in the programme selector (delay indicator light off), select the new delay time required and after waiting a few seconds to allow the control to reset, pull out the programme selector to start the new delay (delay indicator light on).

Always ensure that the Programme Start Delay control is set to the option switch end of the slide underneath the indicator light (Delay indicator light off) when a delay is not required.

Detergents

Washing Powder

Use a low lather powder for front loading automatic machines. This type of powder is specially made to suit front loading automatic washer/dryers and can be used in hard or soft water. Ordinary powders produce so much lather that clothes will not tumble freely or be properly washed and you may even get lather overflow.

Use enough powder. To get your clothes clean it is essential that enough powder is used in the machine. The correct amount will depend on a number of things — the hardness of the water, the size of load and the amount of soiling present. As a guide we suggest you follow the table below and adjust the amounts in the light of your personal experience. You may find it helps to use a cup for measuring the right amount at first. (Do not use a water softener additive in the machine itself).

How much to use in your machine

	Programmes using the Prewash			Programmes not using the Prewash
	Prewash	Main-wash	Total	
HARD WATER				
Full load or heavy soiling	1 cup	2 cups	3 cups	2 cups
Small load or light soiling	1 cup	1 cup	2 cups	1 ½ cups
SOFT WATER				
Full load or heavy soiling	1 cup	1 cup	2 cups	1 ½ cups
Small load or light soiling	½ cup	½ cup	1 cup	¾ cup

One cup holds approximately 100 grams.

Conditioners

A fabric conditioner is strongly recommended. When added it will give a fresh softness to your washing and eliminate the problem of static cling from synthetics.

Fabric conditioner and washing powder can be put in the dispenser at the same time. Add fabric conditioner, in line with the instructions given on the bottle, to the fabric conditioner compartment of the dispenser at the beginning of every wash and your machine will automatically add it to the final rinse.

The use of fabric conditioner in your washer/dryer will also be beneficial in the drying process. Not only will the problem of static be eliminated but your clothes will be softer.

Water Hardness

The tabulation below shows the water hardness throughout the country. In some areas water hardness is variable. There is an accepted standard of measure for classifying the relative hardness of any water:

	Key	Parts per million as CaCO ₃	Degrees Clark	Degrees French
Soft	S	0-50	0-3.5	0-5
Moderately Soft	MS	50-100	3.5-7.0	5-10
Slightly Hard	SH	100-150	7.0-10.5	10-15
Moderately Hard	MH	150-200	10.5-14.0	15-20
Hard	H	200-300	14.0-21.0	20-30
Very Hard	VH	over 300	over 21.0	over 30

Area	Authority	Water Hardness	Area	Authority	Water Hardness	Area	Authority	Water Hardness
Argyll	Scotland	S	Invernesshire	Scotland	S-MH	Salop	Severn-Trent	H
Ashborne	Severn-Trent	MS-H	Ireland Eastern	-	SH	Scilly Isles	-	MH
Avon and Dorset	Wessex	H	Ireland Northern	-	MS	Scotland-Mid	Scotland	S-MH
Ayrshire	Scotland	S	Ireland Southern	-	S-VH	Scotland-North	Scotland	S-VH
Birmingham	Severn-Trent	S-VH	Ireland Western	-	MS	Scotland-North East	Scotland	S
Bolton	North West	S	Isle of Wight	-	SH-H	Scotland-South East	Scotland	S-H
Bournemouth	Wessex	H	Jersey	-	MH	Scotland-South West	Scotland	S-MH
Bristol	Wessex	H-VH	Kent	Southern	H	Sherwood	Severn-Trent	MH-VH
Cambridge	Anglia	SH-H	Kent East	Southern	H	Somerset	Wessex	S-VH
Carlisle	North West	MS	Kent Mid	Southern	SH-VH	Stafford	Severn-Trent	H-VH
Cheshire-Mid	North West	MS-H	Kent West	Southern	MS-H	Staffordshire-South	Severn-Trent	H-VH
Chester	North West	SH-H	Lakes & Lune	North West	S	St. Helens	North West	SH
Chiltern	Thames	VH	Lambourne	Thames	SH-VH	Stockport	North West	S
Clyde-Lower	Scotland	S	Lanarkshire	North West	S-VH	Sunderland &		
Colne Valley	North West	H-VH	Lancashire	North West	S-VH	South Shields	Northumbrian	MS-VH
Corby & District	North West	H	Lee Valley	Thames	VH	Surrey East	Thames	MS
Cumbria South	North West	S-MH	Leicester	Severn-Trent	MH-VH	Surrey North	Thames	H-VH
Cumbria West	North West	S	Liverpool	North West	S-SH	Sussex	Southern	H
Derbyshire-North	Severn-Trent	S-H	Loch Lomond	Scotland	S	Sussex East	Southumbrian	MS
Derbyshire-South	Severn-Trent	MH	Loch Turret	Scotland	S	Sussex Mid	Southern	S-H
Derwent Valley	Severn-Trent	S	London-Metropolitan	Thames	MH-VH	Sussex North West	Southern	MS-VH
East Anglia	Anglia	H-VH	Lune Valley	North West	S-SH	Sutton District	Thames	SH
Eastbourne	Southern	SH-VH	Macclesfield	North West	MS-H	Tees	Northumbrian	S-MS
Eden	North West	S-MH	Makerfield	North West	S-MH	Tendring Hundred	Anglia	H
Essex	Anglia	S-VH	Manchester	North West	S	Truro	South West	S-SH
Exeter	South West	S-H	Mersey Valley	North West	S-VH	Vales	Thames	MS-VH
Fife & Kinross	Scotland	S-VH	Montgomery	Severn-Trent	S-MH	Warwickshire	Severn-Trent	MH-VH
Folkestone & District	Southern	S-VH	Newcastle & Gateshead	Northumbrian	MH	Wear	Northumbrian	S
Fylde	North West	S-SH	Nottingham	Severn-Trent	MS-MH	Wiltshire	Thames	H
Gloucester	Severn-Trent & Thames	MH-VH	Northumberland & Tyne	Northumbrian	SH	Wolverhampton	Severn-Trent	SH-VH
Guernsey	-	SH	Nuneaton	SH-VH	SH-VH	Worcestershire-North	Severn-Trent	S-VH
Hampshire Central	Southern	H	Pennine-West	North West	S-MS	Worcestershire-South	Severn-Trent	MS-H
Hampshire North	Southern	H	Plymouth	South West	S-SH	Wrexham & East		
Hampshire West	Southern	H	Preston & District	North West	S	Denbighshire	Welsh	SH
Hartlepool	Northumbrian	H-VH	Rickmansworth &			York	Yorkshire	H
			Uxbridge Valley	Thames	H-VH	Yorkshire North	Yorkshire	S-VH

Reproduced by Kind Permission of Lever Bros. Ltd.

International Textile Care Label Codes Programme Guide

Care Label/ Programme	Fabric and Soiling	Maximum Load	Select Programme Position	Select Half Load
	Cotton and Linen. White or colour-fast to boiling. Heavy soil.	4.5kg 10lbs		Optional
	Cotton and Linen. White or colour-fast to boiling. Normal soil.	4.5kg 10lbs		Optional
	Cotton and Linen. White or colour-fast to boiling. Light soil.	4.5kg 10lbs		Optional
	Cotton and Linen. Colour-fast at 60°C. Normal soil.	4.5kg 10lbs		Optional
	Cotton and Linen. Colour-fast at 60°C. Light soil.	4.5kg 10lbs		Optional
	Nylon and Polyester/Cotton – White. Normal soil.	2kg 4½ lbs		Optional
	Nylon and Polyester/Cotton – White. Light soil.	2kg 4½ lbs		Optional
	Nylon and Polyester/Cotton – Coloured. Normal soil.	2kg 4½ lbs		Optional
	Nylon and Polyester/Cotton – Coloured. Light soil.	2kg 4½ lbs		Optional
	Cotton and Linen. Colour-fast at 40°C but not at 60°C. Normal soil.	4.5kg 10lbs		Optional
	Cotton and Linen. Colour-fast at 40°C but not at 60°C. Light soil.	4.5kg 10lbs		Optional
	Delicate synthetics, Acrylics, Man-made fibre blankets. Normal soil.	2kg 4½ lbs		Optional
	Delicate synthetics, Acrylics, Man-made fibre blankets. Light soil.	2kg 4½ lbs		Optional
	Woollens (labelled Machine Washable) and Wool Mixtures. Normal soil.	2kg 4½ lbs		No
	Woollens (labelled Machine Washable) and Wool Mixtures. Light soil.	2kg 4½ lbs		No
Rinsing and Spinning**	Any machine-washable fabric requiring rinsing and spinning only.	Dependent on materials	Any rinse position	Optional
Spinning only**	Any machine-washable fabric requiring spinning only.	Dependent on materials	or	–

**See section on page 8 for full description.

The Control Settings on your machine correspond with the International Textile Care Label numbers, which give the correct wash programme for the various fabrics. Selection of the wash programme is therefore simple and straight forward. Look for the wash code numbers on the garment and select the same number on the Programme Selector. Where there are no numbers on garments, the following guide will help you select the right programme.

Washing

Tumble Drying

Select Crease Care	Select Slow Spin	Select Fast Wash	Maximum Load	Recommended Time (Mins.)
Optional	No	No	2.3kg 5lbs	65+ ★
Optional	No	No	2.3kg 5lbs	65+ ★
Optional	No	Yes	2.3kg 5lbs	65+ ★
Optional	No	No	2.3kg 5lbs	65+ ★
Optional	No	Yes	2.3kg 5lbs	65+ ★
Optional	Optional *	No	1.8kg 4lbs	50-70
Optional	Optional *	Yes	1.8kg 4lbs	50-70
Optional	Optional *	No	1.8kg 4lbs	50-70
Optional	Optional *	Yes	1.8kg 4lbs	50-70
Optional	No	No	2.3kg 5lbs	65+ ★
Optional	No	Yes	2.3kg 5lbs	65+ ★
Optional	Yes	No	1.8kg 4lbs	50-70
Optional	Yes	Yes	1.8kg 4lbs	50-70
Optional	No	No	Woollen articles should not be dried in the dryer unless they are labelled 'Superwash', 'Machine-washable' or have the 'May be tumble dried' symbol. If in any doubt do not tumble dry wool.	
Optional	No	Yes	Woollen articles should not be dried in the dryer unless they are labelled 'Superwash', 'Machine-washable' or have the 'May be tumble dried' symbol. If in any doubt do not tumble dry wool.	
Optional	Optional *	—	} Dependent upon materials	
—	Optional *	—		

The time given is for cotton sheeting. For other heavier cotton and linen materials such as towelling, jeans and nappies, longer drying times will be required.

See section on page 5 for full description.

Stain removal

- 1) Always treat as soon as possible. Rinse in cold water or warm solution before washing.
- 2) Never rub a stain, "pinch out" as much as you can, using a clean cloth or paper tissue.
- 3) Some stains need special treatment (see below).
- 4) Absorbent pad method.
With solvents work from outside towards centre of stain, holding an absorbent pad underneath the cloth behind the stain.
- 5) Do not use Amyl Acetate on acetate or triacetate.

Note:

Take great care with poisonous chemicals and flammable liquids.

Only use solvents in a well ventilated place.

Keep chemicals, flammable liquids and solvents out of reach of children.

NEVER TUMBLE DRY ANY ARTICLE ON WHICH SOLVENTS HAVE BEEN USED WITHOUT FIRST WASHING AND RINSING THOROUGHLY.

Stubborn Stain Guide

Carbon paper	Methylated Spirits	Absorbent pad method	Or rub with ice and pick off by hand Waterproof glue should be treated with Amylacetate using absorbent pad method
Chewing gum	Methylated Spirits	Absorbent pad method	
Glue	Cold Water or Amyl Acetate	Wash in cold solution for soluble glues	
Grass	Methylated Spirits	Sponge with methylated spirits	
Grease/Oil	Proprietary grease solvent	Absorbent pad method	
Ink (biro, felt tip)	Methylated Spirits	Absorbent pad method	
Lipstick and face creams	Proprietary grease solvent	Absorbent pad method	
Mildew/white cottons and linens	Chlorine bleach	Soak white cottons and linens in 1 part bleach in 100 parts water	
Mildew (all other white fabrics)	Hydrogen peroxide	Soak other white fabrics in 1 part hydrogen peroxide 20 vol. to 4 parts water	
Nail varnish	Amyl Acetate	Absorbent pad method	
Paint: Emulsion	Water	Sponge immediately with cold water	Coloured cannot be treated except for regular washing Rinse well. There is no safe home treatment for coloured but regular washing will reduce marks
Paint: Oil	Turpentine or Amyl Acetate	Absorbent pad method	
Perspiration	Hydrogen peroxide	Rinse immediately in cold water and wash. If stain remains soak in 1 part hydrogen peroxide 20 vol. 4 parts water and wash	Dried stains are permanent
Rust/iron mould (for all fabrics)	Lemon juice	Soak stains in lemon juice and iron under damp cloth. Repeat if necessary	
Rust/iron mould (for white cottons and linens)	Oxalic acid (very poisonous)	Use ½ teaspoon of oxalic acid in ½ pint of hot water	Colour removed by perspiration cannot be restored
Shoe polish	Glycerine and proprietary grease solvent	Lubricate with glycerine and use solvent with absorbent pad method	
Tar	Proprietary grease solvent	Scrape off surplus, soften with butter and wipe off, apply solvent and wash immediately	

REPRODUCED BY KIND PERMISSION OF LEVER BROS. LIMITED

Care & Cleaning

After use of the appliance:—

- (a) Press the Power button to switch the machine off. Switch off the supply at the socket. Turn off the water taps.
- (b) Open the door. Clean and dry the rubber door seal and porthole. Close the door.
- (c) Occasionally remove the detergent dispenser drawer from the detergent box by pulling out sharply beyond the stop. Clean powder and fabric conditioner deposits from the drawer and from inside the box. Remove the syphon cap from the drawer and wash in clean water. Replace the syphon ensuring that it is fitted correctly. Replace the drawer. To overcome the initial resistance, the front face of the drawer should be stuck with the palm of the hand.
- (d) Wipe the cabinet and top with a clean damp cloth. A cleaner may be used but should not contain any abrasive that could damage the paintwork or plastic mouldings.

Occasionally select a rinse and spin programme with the drum empty. This will wash away any remaining fluff and ensures that this is not redeposited on the wash load. **This is particularly important if you regularly dry fluffy loads, e.g., nappies, towels, etc.**

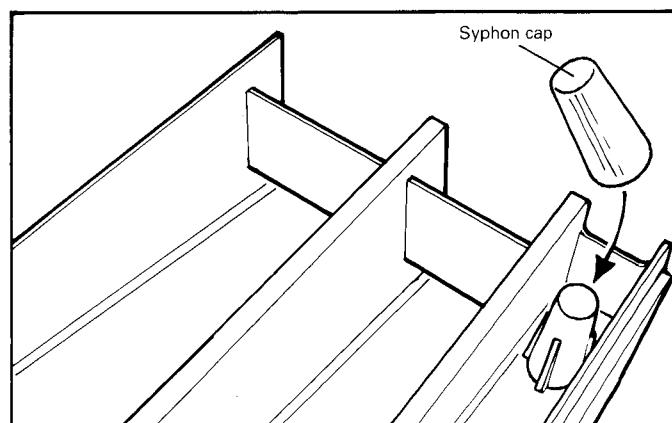

Checking Water Pressures

Operating water pressures

Minimum: 27 kilonewtons per square metre (4 p.s.i.)

Maximum: 979 kilonewtons per square metre (142 p.s.i.)

You should check that your water pressures are satisfactory by carrying out the following tests.

Cold water

With the taps full on check the time it takes for the machine to fill.

1. Close the door.
2. Pull out the detergent drawer 2 to 3 inches.
3. Select Auto Prewash Programme 
Pull out the Programme Selector knob to start the machine filling. Measure the time it takes from pulling the Programme Selector until the water stops flowing into the detergent drawer. This time should not exceed 4 minutes. If the time exceeds 4 minutes, then the water flow is insufficient and the flow control washer must be removed from the cold water inlet. (See Fig. A). Before doing this empty the machine by following point 4 below.
4. Push the Programme Selector Knob in to stop machine.
5. Turn the Programme Selector to the final spin position. Pull out the Programme Selector and allow the machine to empty.

6. Push in the Programme Selector to stop machine when empty.
Removing the washer will reduce the time to fill, but if the time has not been reduced to less than 5 minutes or if the water inlet valve fails to open, your water pressure is too low and you should contact your local Service Depot.

Hot water

1. Close the door and Pull out detergent drawer 2 to 3 inches.
2. Set the Programme Selector Dial to Programme 
This is hot fill.
3. Pull out the Programme Selector Knob to start the machine filling. Measures the time it takes from pulling out the Programme Selector until the water stops flowing. This time should be between 2 and 5 minutes. If the time exceeds 5 minutes then the water flow is insufficient and the flow control washer must be removed from the hot water inlet. (See Fig. A).
4. Push the Programme Selector Knob in to stop machine.
5. Turn the Programme Selector to the final spin position.

Pull out the Programme Selector and allow the machine to empty.

6. Push in Programme Selector to stop machine when empty.
Removing the washer will reduce the time to fill, but if the time has not been reduced to less than 5 minutes or if the water inlet valve fails to open, your water pressure is too low and you should contact your local Service Depot.

To remove flow control washer

1. Turn the power off and turn the taps off.
2. Remove the appropriate water hose from the rear of the machine by unscrewing the plastic retaining nut (see Fig. B).
3. Remove the filter and the flow control washer from the water inlet. If the filter is tightly held in the valve use pliers. (See Fig. A).
4. Replace the filter taking care that it is pushed fully home and properly seated into the valve.
5. Refit the filler hose ensuring that the seal washer is securely fitted inside the plastic nut (see Fig. B) and then repeat the water filling test.
Do not overtighten (see Installation Instructions).

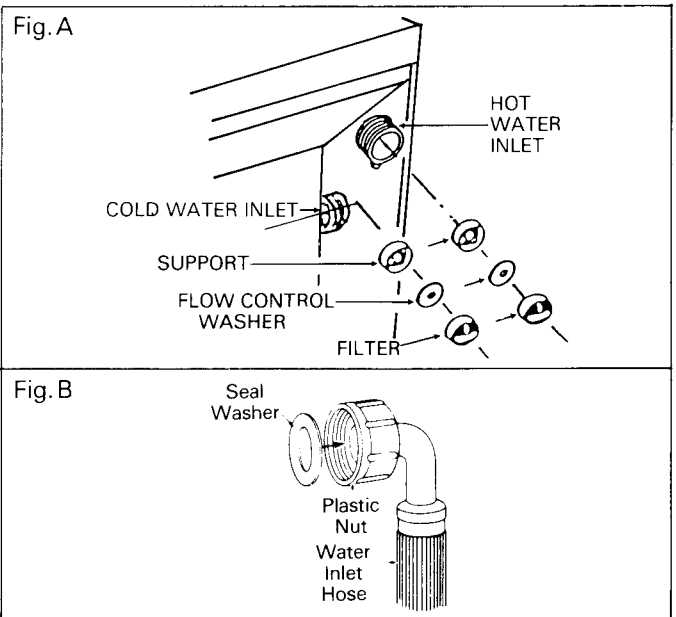

Regular Checks

It is essential that you use and look after your washer/dryer in accordance with the instructions in this book.

As with any major appliance, there are certain aspects which require regular attention. Without such attention, it is possible that there may be a premature requirement for servicing.

Listed below are a number of such key areas which in your own interests you should check regularly.

Before calling out a service engineer, ensure that the checks below and on page 14 have been carried out. Should the service engineer find nothing wrong with the machine, we regret that we will have to charge for the service call.

Key Regular Check Items

Water Leaks

1.1 From Back of Machine

- Are the inlet hoses securely tightened? (see above).
- Is the flow control washer fitted inside the filter? (see above).
- Is the outlet hose correctly and securely positioned?

1.2 From Front of Machine

- Check that there is no dirt or lint trapped between the lip of the rubber door seal and the door glass.
- Check that the detergent dispenser is not prevented from closing tightly due to a build-up of detergent. Remove and clean (see Page 12).

2. Insufficient Inlet Flow Rates

- Check that the hot and cold water pressures are satisfactory. Check that the filters in the inlet valve are not blocked, and if necessary remove the flow control washer which will reduce the time to fill. (See above).

3. Machine Vibrating

- Check that the transit brackets have been removed (see Installation Instructions).
- Check that the machine is level.

4. Option Switches

- Check after use that all the option switches are in the **Off** position, i.e. out.

Something Wrong With Your Machine

Before calling out a Service engineer have a quick look through the following fault finding list — it could save a lot of time and trouble.

SYMPTOMS	POSSIBLE CURE
It won't start	Is it switched on at the mains? Is there a fuse in the plug and, if so, has it blown? Are all the wires in the plug correctly secure? Has the power switch been pressed in? Is the Programme Selector fully pulled out? Has the washing programme been set? Has the drying cycle selector been set? Is the door properly shut? Has a programme start delay been selected? (SDL Machine only).
It doesn't fill	Are the taps and stop cocks turned on? Are the water inlet hoses kinked? Have you switched the machine on?
It's slow to fill	Check that the water pressure is correct and that the water filters are clean. (See page 13). Are water taps in use elsewhere in the house?
It won't empty	Is the drain hose kinked?
It takes a long time to heat up	Your own hot water supply may not be hot enough so that it takes the machine longer to heat the water to the wash starting temperature. Check fill hose connections, they may be the wrong way round.
Drum keeps on stopping and starting	It should do, as this is the normal washing and drying action.
Suds are overflowing	You could be using the wrong type of powder or too much. To remove the suds, push in the Programm Selector. Advance it to the rinse section and pull it out, to turn the machine back on. Allow the rinse cycle to finish.
Machine stops at end of final rinse	Is the 'Crease Care' switch selected?
Door will not open	Check that:— 1. The power is switched Off and the Programme Selector is pushed in. 2. The machine is stopped (drum stationary).

SYMPTOMS	POSSIBLE CURE
It makes a noise when it spins	Some noise is unavoidable with all machines. However, it helps if the machine is standing on a flat surface and not touching anything. If persistent, check that transit packing has been removed properly. (See Installation Sheet).
Machine continually emptying	This is probably as a result of the end of the outlet hose being less than 55cm. from the floor.
Water is leaking out	Are the hot and cold water inlet hose connections to the machine tight enough and are the seal washers in position? Is the detergent dispenser drawer fully closed? Is the outlet from the detergent dispenser blocked?
It takes longer than normal to dry	Have you selected the correct time on the drying selector? Have you selected the correct drying programme (see page 6). Are there too many garments in the drum? Have you forgotten to turn the cold water supply on for drying cycle? Have you selected the Slow Spin switch?
The clothes come out wet	Have you selected the wrong programme for the type of fabric (see Programme Guide). Have you neglected to select a drying position? Have you selected a cool tumble position only? Have you dried too many garments in weight? Have you forgotten to turn the cold water supply on for drying cycle? Have you selected the Slow Spin switch?

In the Event of a Power cut/ Failure

If you have a power failure and you wish to remove the clothes from the machine, carry out the following:—

1. Switch off the electricity supply at the socket and remove the plug.
2. Drain the machine, if water can be seen in the door window, by lowering the outlet hose into a bucket or bowl. Take care, as the water could be very hot and may fill more than one bowl. To stop the flow just raise the drain hose. You can completely empty the machine of water in this way.
3. The door may now be opened.

If you have been through the above and your machine still is not working properly you should call your nearest Service office. See back cover.

CredaCare – Your Guarantee

CredaCare puts more life into your machine. CredaCare is an option which can be taken up within 30 days from the date of purchase of your appliance. It means that any replacement parts* necessary outside the guarantee period but within five years of purchase will be supplied free. The parts will be expertly fitted by Creda's own service organisation at fixed low rates. (See separate leaflet for full details).

*Does not include decorative parts

Guarantee

This guarantee is offered as an extra benefit and does not affect your legal rights.

All components whether or not of Creda manufacture are guaranteed against defective manufacture whether due to defective materials or workmanship within a period of twelve calendar months from the date of purchase or hire purchase agreement. This guarantee is subject to the provisions that the appliance has:—

- been used solely for domestic purposes.
- been used in accordance with the instruction leaflet.
- been properly connected to a suitable supply voltage as stated on the appliance rating plate.
- not been subjected to misuse, accident, or been repaired or modified by any person other than an authorised employee or agent.
- been installed in accordance with the Creda Installation Instructions.

Applicable to UK only.

Optional Extras

If only a cold water supply is available, you will need a special adaptor. This is available as an optional extra. Available as an optional extra for the L17306/17316 washer dryers is a hardwearing and durable Worktop which will replace the metal worktop supplied with your machine. The worktop is already fitted on the DL17307/17316 machines.

Also available are longer fill hoses and a drain hose extension kit for applications where it is not possible to move the house plumbing closer to the machine.

These can be obtained from your local retailer or Creda Limited, Spare Parts Department, CDAS Building, Creda Works, Blythe Bridge, Stoke-on-Trent ST11 9LN. Telephone: 0782 388300.

Plumbing Service

Creda Domestic Appliance Service offer a plumbing-in service for Creda appliance owners at competitive rates.

If you require your washing machine to be professionally installed please contact your local CredaCare number for a quotation. See back cover.

SPARE PARTS

Creda Limited, Spare Parts Department, CDAS Building, Creda Works, Blythe Bridge, Stoke-on-Trent ST11 9LN. Telephone: 0782 388300.

How to Obtain After Sales Service Quickly

Make a note of your nearest Creda Domestic Appliance Service Ltd. depot telephone number here:

The receptionist will need the answer to certain questions so to save you time and money please have the following information ready in case you have to call us.

Before calling out a Service Engineer, ensure that the checks on pages 13 and 14 have been carried out. Should the Service Engineer find nothing wrong with the machine, we regret that we will have to charge for the service call.

Your name and address

Telephone number

Name of the appliance (e.g. Washer/Dryer L or SDL)

Model number

The serial number (shown on the rating plate on the back panel and on the inside face of the door hinge).

Name and Branch of Shop from which you bought the appliance

Date of purchase

If free service under guarantee is required, please have available proof of date of purchase when our engineer calls.

- The receptionist will then advise you of the proposed date of our engineer's visit, and, if you so request, will offer you an a.m. or p.m. call.
- All chargeable work is on a cash basis and our service engineer will issue a receipt. He will accept a cheque supported by a cheque card.
- Our service engineers carry identity cards with a photograph.



Key Contacts

After Sales Service

Over 1100 trained specialists, directly employed by us, ensure that you have complete confidence in both the appliances and services we offer.

Repair Service

UK: 08709 066 066

(Open 8 to 8 Mon - Fri, 8 to 6 Sat & 10 to 4 Sun)

www.theservicecentre.co.uk

Republic of Ireland: 1850 302 200

Note: Our Service Operators will require the following information:

Model Number

Serial Number

Extended Warranties

UK: 08709 088 088

(Open 8 to 6 Mon - Fri)

www.theservicecentre.co.uk

Republic of Ireland: 1850 502 200

Genuine Parts and Accessories

UK: 08709 077 077

(Open 8-30 to 5-30 Mon - Fri, 8-30 to 12 Sat)

www.theservicecentre.co.uk

Republic of Ireland: (01) 842 6836

General Domestic Appliances Limited, Morley Way, Peterborough, PE2 9JB

Free Manuals Download Website

<http://myh66.com>

<http://usermanuals.us>

<http://www.somanuals.com>

<http://www.4manuals.cc>

<http://www.manual-lib.com>

<http://www.404manual.com>

<http://www.luxmanual.com>

<http://aubethermostatmanual.com>

Golf course search by state

<http://golfingnear.com>

Email search by domain

<http://emailbydomain.com>

Auto manuals search

<http://auto.somanuals.com>

TV manuals search

<http://tv.somanuals.com>