

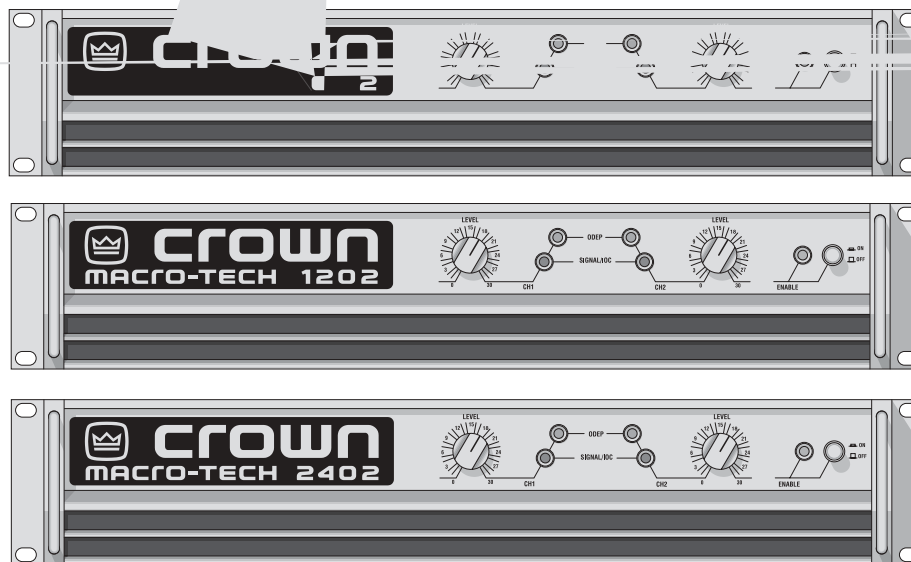

Macro-Tech 02 Series

Operation Manual



**Macro-Tech
602, 1202 & 2402**

Obtaining Other Language Versions: To obtain information in another language about the use of this product, please contact your local Crown Distributor. If you need assistance locating your local distributor, please contact Crown at 574-294-8000.

This manual does not include all of the details of design, production, or variations of the equipment. Nor does it cover every possible situation which may arise during installation, operation or maintenance.

The information provided in this manual was deemed accurate as of the publication date. However, updates to this information may have occurred. To obtain the latest version of this manual, please visit the Crown website at www.crownaudio.com.

Trademark Notice: Crown, Amcron, Macro-Tech and ODEP are registered trademarks of Crown International. PIP and Grounded Bridge are trademarks of Crown International. Other trademarks are the property of their respective owners.

Some models may be exported under the name Amcron.®

©2004 by Crown Audio, Inc. P.O. Box 1000, Elkhart, Indiana 46515-1000 U.S.A. Telephone: 574-294-8000

H A Harman International Company

127240-5
3/04

Important Safety Instructions

- 1) Read these instructions.
- 2) Keep these instructions.
- 3) Heed all warnings.
- 4) Follow all instructions.
- 5) Do not use this apparatus near water.
- 6) Clean only with a dry cloth.
- 7) Do not block any ventilation openings. Install in accordance with the manufacturer's instructions.
- 8) Do not install near any heat sources such as radiators, heat registers, stoves, or other apparatus that produce heat.
- 9) Do not defeat the safety purpose of the polarized or grounding-type plug. A polarized plug has two blades with one wider than the other. A grounding-type plug has two blades and a third grounding prong. The wide blade or the third prong is provided for your safety. If the provided plug does not fit into your outlet, consult an electrician for replacement of the obsolete outlet.
- 10) Protect the power cord from being walked on or pinched, particularly at plugs, convenience receptacles, and the point where they exit from the apparatus.
- 11) Only use attachments/accessories specified by the manufacturer.
- 12) Use only with a cart, stand, bracket, or table specified by the manufacturer, or sold with the apparatus. When a cart is used, use caution when moving the cart/apparatus combination to avoid injury from tip-over.
- 13) Unplug this apparatus during lightning storms or when unused for long periods of time.
- 14) Refer all servicing to qualified service personnel. Servicing is required when the apparatus has been damaged in any way, such as power-supply cord or plug is damaged, liquid has been spilled or objects have fallen into the apparatus, the apparatus has been exposed to rain or moisture, does not operate normally, or has been dropped.
- 15) To reduce the risk of fire or electric shock, do not expose this apparatus to rain or moisture.



TO PREVENT ELECTRIC SHOCK DO NOT REMOVE TOP OR BOTTOM COVERS. NO USER SERVICEABLE PARTS INSIDE. REFER SERVICING TO QUALIFIED SERVICE PERSONNEL.



À PRÉVENIR LE CHOC ÉLECTRIQUE N'ENLEVEZ PAS LES COUVERCLES. IL N'Y A PAS DES PARTIES SERVICEABLE À L'INTÉRIEUR. TOUS REPARATIONS DOIT ÊTRE FAIRE PAR PERSONNEL QUALIFIÉ SEULEMENT.



CAUTION
RISK OF ELECTRIC SHOCK
DO NOT OPEN

AVIS
RISQUE DE CHOC ÉLECTRIQUE
N'OUVREZ PAS

IMPORTANT

MA Series amplifiers require Class 2 output wiring.



MAGNETIC FIELD

CAUTION! Do not locate sensitive high-gain equipment such as preamplifiers or tape decks directly above or below the unit. Because this amplifier has a high power density, it has a strong magnetic field which can induce hum into unshielded devices that are located nearby. The field is strongest just above and below the unit.



If an equipment rack is used, we recommend locating the amplifier(s) in the bottom of the rack and the preamplifier or other sensitive equipment at the top.

WATCH FOR THESE SYMBOLS:

The lightning bolt triangle is used to alert the user to the risk of electric shock.



The exclamation point triangle is used to alert the user to important operating or maintenance instructions.



FCC COMPLIANCE NOTICE

This device complies with part 15 of the FCC rules. Operation is subject to the following two conditions: (1) This device may not cause harmful interference, and (2) this device must accept any interference received, including interference that may cause undesired operation.

CAUTION: Changes or modifications not expressly approved by the party responsible for compliance could void the user's authority to operate the equipment.

NOTE: This equipment has been tested and found to comply with the limits for a Class B digital device, pursuant to part 15 of the FCC Rules. These limits are designed to provide reasonable protection against harmful interference in a residential installation. This equipment generates, uses, and can radiate radio frequency energy and, if not installed and used in accordance with the instruction manual, may cause harmful interference to radio communications. However, there is no guarantee that interference will not occur in a particular installation. If this equipment does cause harmful interference to radio or television reception, which can be determined by turning the equipment off and on, the user is encouraged to try to correct the interference by one or more of the following measures:

- Reorient or relocate the receiving antenna.
- Increase the separation between the equipment and receiver.
- Connect the equipment into an outlet on a circuit different from that to which the receiver is connected.
- Consult the dealer or an experienced radio/TV technician for help.

Crown International, Inc.

DECLARATION of CONFORMITY

TCF Technical Certificate No: P4300CRI1.IWS

Technical Construction File Route

Issued By: Crown International, Inc.
1718 W. Mishawaka Road
Elkhart, Indiana 46517 U.S.A.

Sue Whitfield
574-294-8289
swhitfield@crowintl.com

Competent Body's Name and Address:

Technology International (Europe) Limited
41-42 Shrivensham Hundred Business Park,
Shrivensham, Swindon, Wilts, SN6 8TZ

European Representative's Name and Address:

Nick Owen
19 Clos Nant Coslech
Pontprennau
Cardiff
CF23 8ND United Kingdom

Equipment Type: Commercial Audio Power Amplifiers

Family Name: Macro-Tech

Model Names: Macro-Tech Series

EMC Standards:

EN 55103-1:1995 Electromagnetic Compatibility - Product Family Standard for Audio, Video, Audio-Visual and Entertainment Lighting Control Apparatus for Professional Use, Part 1: Emissions

EN 55103-1:1995 Magnetic Field Emissions-Annex A @ 10 cm and 1 M

EN 61000-3-2:1995+A14:2000 Limits for Harmonic Current Emissions (equipment input current ≤16A per phase)

EN 61000-3-3:1995 Limitation of Voltage Fluctuations and Flicker in Low-Voltage Supply Systems Rated Current ≤16A

EN 55022:1992 + A1: 1995 & A2:1997 Limits and Methods of Measurement of Radio Disturbance Characteristics of ITE: Radiated, Class B Limits; Conducted, Class B

EN 55103-2:1996 Electromagnetic Compatibility - Product Family Standard for Audio, Video, Audio-Visual and Entertainment Lighting Control Apparatus for Professional Use, Part 2: Immunity

EN 61000-4-2:1995 Electrostatic Discharge Immunity (Environment E2-Criteria B, 4k V Contact, 8k V Air Discharge)

EN 61000-4-3:1996 Radiated, Radio-Frequency, Electromagnetic Immunity (Environment E2, criteria A)

EN 61000-4-4:1995 Electrical Fast Transient/Burst Immunity (Criteria B)

EN 61000-4-5:1995 Surge Immunity (Criteria B)

EN 61000-4-6:1996 Immunity to Conducted Disturbances Induced by Radio-Frequency Fields (Criteria A)

EN 61000-4-11:1994 Voltage Dips, Short Interruptions and Voltage Variation

Safety Standard:

EN 60065: 1998 Safety Requirements - Audio Video and Similar Electronic Apparatus

I certify that the product identified above conforms to the requirements of the EMC Council Directive 89/336/EEC as amended by 92/31/EEC, and the Low Voltage Directive 73/23/EES as amended by 93/68/EEC.

Signed

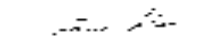

Larry Coburn

Title: Senior Vice President of Manufacturing

Date of Issue: March 28, 2000

Due to line current harmonics, we recommend that you contact your supply authority before connection.

Table of Contents

Important Safety Instructions	2	5.1.2 Standby Mode	14
Declaration of Conformity	3	5.1.3 Transformer Thermal Protection	14
1 Welcome	5	5.1.4 Fuses and Circuit Breakers	15
1.1 Features	5	5.2 Advanced Features	15
2 How to Use This Manual	5	5.3 Options	16
3 Setup	6	5.3.1 PIP and PIP2 Modules	16
3.1 Unpack Your Amplifier	6	5.3.2 Cooling Fan Options	17
3.2 Install Your Amplifier	6	5.3.3 Level Control Shaft Lock	17
3.3 Ensure Proper Cooling	6	6 Troubleshooting	18
3.4 Choose Input Wire and Connectors	7	7 Theory of Operation	19
3.5 Choose Output Wire and Connectors...	7	7.1 Overview	19
3.6 Wire Your System	8	7.2 Circuit Theory	19
3.6.1 Stereo Mode	8	7.2.1 Stereo Operation	19
3.6.2 Bridge-Mono Mode	8	7.2.2 Bridge-Mono Operation	20
3.6.3 Parallel-Mono Mode	9	7.2.3 Parallel-Mono Operaton	20
3.7 Set Input Sensitivity	10	8 Specifications	21
3.8 Connect to AC Mains	10	9 AC Power Draw and Thermal Dissipation ..	30
3.9 Startup Procedure	10	10 Service	32
4 Operation	10	10.1 Worldwide Service	32
4.1 Precautions	10	10.2 US and Canada Service	32
4.2 Front Panel Controls and Indicators	11	10.2.1 Service at a US or Canada Service	
4.3 Back Panel Controls, Indicators and		Center	32
Connectors	12	10.2.2 Factory Service	32
4.4 Indicators	13	10.2.3 Factory Service Shipping	
5 Advanced Features and Options	14	Instructions	32
5.1 Protection Systems	14	11 Warranty	33
5.1.1 ODEP	14	Factory Service Information Form	35

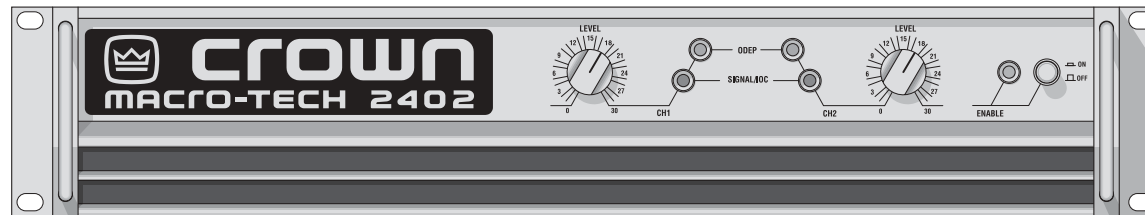

MA-602	*1 kHz Power	**20 Hz-20 kHz Power
2 ohm Dual (per ch.)	400W	335W
4 ohm Dual (per ch.)	325W	300W
8 ohm Dual (per ch.)	225W	210W
4 ohm Bridge-Mono	750W	650W
8 ohm Bridge-Mono	655W	605W

*1 kHz Power: refers to maximum average power in watts at 1 kHz with 0.1% THD.
 **20 Hz-20 kHz Power: refers to maximum average power in watts from 20 Hz to 20 kHz with 0.1% THD.

MA-1202	*1 kHz Power	**20 Hz-20 kHz Power
2 ohm Dual (per ch.)	675W	585W
4 ohm Dual (per ch.)	480W	450W
8 ohm Dual (per ch.)	310W	295W
4 ohm Bridge-Mono	1,300W	1,130W
8 ohm Bridge-Mono	970W	895W

*1 kHz Power: refers to maximum average power in watts at 1 kHz with 0.1% THD.
 **20 Hz-20 kHz Power: refers to maximum average power in watts from 20 Hz to 20 kHz with 0.1% THD.

MA-2402	*1 kHz Power	**20 Hz-20 kHz Power
2 ohm Dual (per ch.)	1,050W	850W
4 ohm Dual (per ch.)	800W	750W
8 ohm Dual (per ch.)	520W	505W
4 ohm Bridge-Mono	2,070W	1,670W
8 ohm Bridge-Mono	1,585W	1,485W

*1 kHz Power: refers to maximum average power in watts at 1 kHz with 0.1% THD.
 **20 Hz-20 kHz Power: refers to maximum average power in watts from 20 Hz to 20 kHz with 0.1% THD.

1 Welcome

Congratulations on purchasing one of the renowned Crown® *Macro-Tech*® power amplifiers. They are designed to provide enormous levels of pure, undistorted power in a rugged, low-profile package — making them *the choice* for pro sound reinforcement. They utilize our patented *ODEP*® protection circuitry to *keep the show going* long after other amplifiers have shut down. And with their *PIP*™ expandability, Macro-Tech amplifiers can be easily customized with one of our many optional input modules (see Section 5 for a list of available PIPs).

Modern power amplifiers are sophisticated pieces of engineering capable of producing extremely high power levels. They must be treated with respect and correctly installed if they are to provide the many years of reliable service for which they were designed.

In addition, the Macro-Tech 02 Series amplifiers include a number of features which require some explanation before they can be used to their maximum advantage.

Please take the time to study this manual so that you can obtain the best possible service from your amplifier.

1.1 Features

- Crown's *Grounded-Bridge*™ design delivers large voltage swings without using easily stressed output-transistor configurations like conventional amplifiers. The results are lower distortion and superior reliability.

- Patented *ODEP* (Output Device Emulation Protection) circuitry compensates for overheating and overload to keep the amplifier working when others would fail.
- Complete protection against shorted, open, and mismatched loads, overheating, DC, high-frequency overload, and full internal fault protection provided by our latest protection scheme: "Quad-Mute."
- Two mono modes (Bridge-Mono and Parallel-Mono) for driving a wide range of load impedances.
- Dedicated power supply transformers isolate channels in Stereo mode for superb crosstalk characteristics and reliability — each channel is virtually a separate amplifier.
- High damping factor provides superior control over low-frequency drivers for a clean, accurate low end.
- *PIP* (Programmable Input Processor) connector accepts accessories that tailor the amplifier to suit specific applications.
- Enhanced *PIP2*™ (Programmable Input Processor) connector accepts new accessory modules that further tailor the amplifier to suit specific applications, including wideband load current monitoring.
- Backed by the industry's ONLY three-year, no-fault, fully transferable warranty.

2 How to Use This Manual

This manual provides you with the necessary information to safely and correctly set up and operate your amplifier. It does not cover every aspect of installation, setup or operation that might occur under every condition. For additional information, please consult Crown's *Amplifier Application Guide* (available online at www.crownaudio.com), Crown Technical Support, your system installer or retailer.

We strongly recommend you read all instructions, warnings and cautions contained in this manual. Also, for your protection, please send in your warranty registration card today. And save your bill of sale—it's your official proof of purchase.

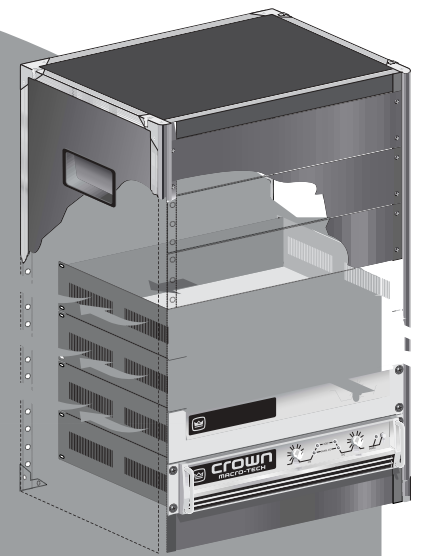

rown

pac

ial

3 Setup

3.4 Choose Input Wire and Connectors

Crown recommends using pre-built or professionally wired, balanced line (two-conductor plus shield), 22-24 gauge cables and connectors. The factory-installed PIP2-FXQ input module accepts 3-pin male XLR connectors or TRS phone connectors. Other PIP modules accept XLR, phone or Phoenix connectors, or bare wires.

Regarding the PIP2-FXQ, Figure 3.3 shows connector pin assignments for balanced wiring, and Figure 3.4 shows connector pin assignments for unbalanced wiring.

NOTE: Custom wiring should only be performed by qualified personnel.

3.5 Choose Output Wire and Connectors

Crown recommends using pre-built or professionally wired, high-quality, two-conductor, heavy gauge speaker wire. Use bare wire, a dual banana plug or spade lugs on the amplifier end of each speaker cable (Figure 3.5). To prevent the possibility of short-circuits, wrap or otherwise insulate exposed loudspeaker cable connectors.

Using the guidelines below, select the appropriate size of wire based on the distance from amplifier to speaker.

Distance	Wire Size
up to 25 ft.	16 gauge
26-40 ft.	14 gauge
41-60 ft.	12 gauge
61-100 ft.	10 gauge
101-150 ft.	8 gauge
151-250 ft.	6 gauge

CAUTION: Never use shielded cable for output wiring.

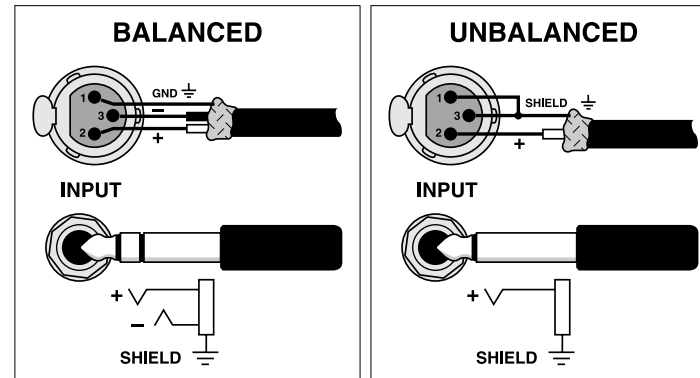

Figure 3.3 Balanced Input Connector Wiring

Figure 3.4 Unbalanced Input Connector Wiring

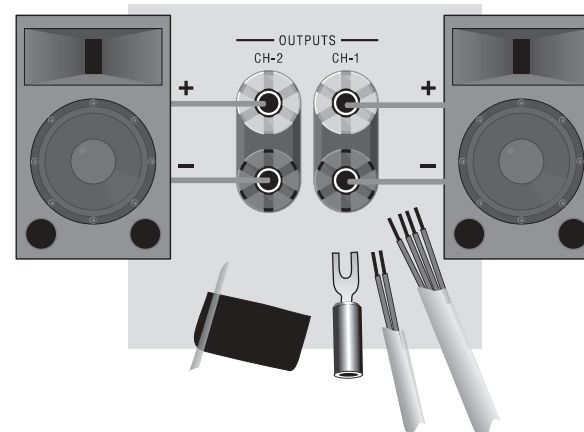

Figure 3.5 Output Connector Wiring

00
10
00
00

3 Setup

3.6.3 Parallel-Mono Mode

See Figure 3.8. Set the back panel stereo/mono switch to Parallel-Mono.

INPUTS: Connect input wiring to Channel 1 only.

OUTPUTS: Add a 14 gauge (or larger) jumper between the red(+) Channel 1 and Channel 2 binding posts. Connect the speaker positive (+) lead to the Channel 1 red (+) terminal. Connect the speaker negative (-) lead to the Channel 1 black (-) terminal.

Crown provides a reference of wiring pin assignments for commonly used connector types in the *Crown Amplifier Application Guide*.

NOTE: Use only the Channel 1 level control.



CAUTION: Parallel-Mono wiring requires installation of a jumper wire. Do not switch to Stereo or Bridge-Mono mode until this output jumper wire is removed.

NOTE: The Channel 2 IOC indicator will remain lit when operating in Parallel-Mono mode.

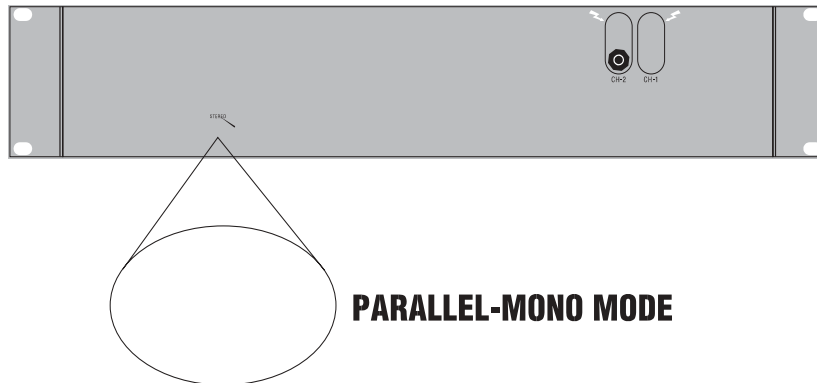

Figure 3.8
Parallel-Mono
Wiring

3.7 Set Input Sensitivity

The input sensitivity switch inside the amplifier is set to 0.775 volt RMS at the factory. (Factory setting for international models is 1.4V). It can be changed to 1.4 volts or a voltage gain of 26 dB. The 26 dB gain setting is equivalent to a sensitivity of 2.2 volts for the Macro-Tech 602, 2.6 volts for the Macro-Tech 1202 and 3.1 volts for the Macro-Tech 2402.

To change the input sensitivity:

1. Turn off and unplug the amplifier from the AC source.
2. Remove the input module on the back panel.
3. Locate the labeled access hole for the sensitivity switch (Figure 3.9). The sensitivity switch will not be visible because it is mounted below the hole. Use your little finger to reach it.
4. Set the switch to the desired position.
5. Replace the input module.

3.8 Connect to AC Mains

Connect your amplifier's power cord to the AC mains power source (power outlet).

WARNING: The third prong of this connector (ground) is an important safety feature. Do not attempt to disable this ground connection by using an adapter or other methods.

Amplifiers don't create energy. The AC mains voltage and current must be sufficient to deliver the power you expect. You must operate your amplifier from an AC mains power source with not more than 10% variation above or below the amplifier's specified line voltage and within the specified frequency requirements (indicated on the amplifier's back panel label). If you are unsure of the output voltage of your AC mains, please consult your electrician.

3.9 Startup Procedure

Use the following procedure when first turning on your amplifier:

1. Turn down the level of your audio source.
2. Turn down the Level controls of the amplifier.
3. Turn on the Power switch. The Enable indicator next to the Power switch should glow. The amber ODEP lights should also be glowing.
4. Turn up the level of your audio source to an optimum level.
5. Turn up the Level controls on the amplifier until the desired loudness or power level is achieved.
6. Turn down the level of your audio source to its normal range.

If you ever need to make any wiring or installation changes, **don't forget to disconnect the power cord.**

For help with determining your system's optimum gain structure (signal levels) please refer to the *Crown Amplifier Application Guide*, available online at www.crownaudio.com.

4 Operation

4.1 Precautions

Your amplifier is protected from internal and external faults, but you should still take the following precautions for optimum performance and safety:

1. Before use, configure your amplifier for proper operation as described in the Setup section of this manual. Improper wiring can result in serious operating difficulties. For advanced setup techniques, consult Crown's *Amplifier Application Guide* available online at www.crownaudio.com.
2. Use care when making connections, selecting signal sources and controlling the output level. The load you save may be your own!
3. Do not short the ground lead of an output cable to the input signal ground. This may form a ground loop and cause oscillations.
4. Never connect the output to a power supply, battery or power main. Electrical shock may result.
5. Tampering with the circuitry, or making unauthorized circuit changes may be hazardous and invalidates all agency listings.
6. Do Not operate the amplifier with the IOC LED constantly flashing bright green.
7. Do Not overdrive the mixer, which will cause clipped signal to be sent to the amplifier. Such signals will be reproduced with extreme accuracy, and loudspeaker damage may result.
8. Do Not operate the amplifier with less than the rated load impedance. Due to the amplifier's output protection, such a configuration may result in premature clipping and speaker damage.

Crown is not liable for damage that results from overdriving of T D0.001.2tema components.

4 Operation

4.2 Front Panel Controls and Indicators

The diagram below shows the controls and indicators on the front panel of the Macro-Tech 02 Series.

A. Dust Filters

The dust filters remove large particles from the air drawn in by the cooling fan. Check the filters regularly to prevent clogging. The filter elements can be easily removed for cleaning by gently pulling them away from the front panel.

B. Level Controls

The output level for each channel is set with these convenient Level controls mounted on the front panel. Each level control has 31 detents for precise adjustment. A security option is available to prevent tampering (see Section 5.3.3).

C. Signal/IOC® Indicators

These green multifunction indicators show signal presence and distortion for each channel. As signal presence indicators, they flash synchronously with the output audio signals to show their presence. As IOC (Input/Output Comparator) indicators, they flash brightly with a 0.1 second hold delay if there is a difference of 0.05% or more between the input and output signal waveforms. This provides proof of distortion-free performance. Note: The Channel 2 IOC indicator stays on in Parallel-Mono mode (see Section 3.6.3).

D. ODEP Indicators

During normal operation of the ODEP (Output Device Emulation Protection) circuitry, these amber indicators glow brightly to show the presence of reserve thermal-dynamic energy.

They dim proportionally as energy reserves decrease. In the rare event that energy reserves are depleted, the indicators turn off and ODEP proportionally limits output drive so the amplifier can safely continue operating even under severe conditions. These indicators can also help identify more unusual operating conditions (see Section 5.1.1).

E. Enable Indicator

This indicator lights when the amplifier has been "enabled" or turned on, and AC power is available.

F. Enable Switch

This push button is used to turn the amplifier on and off. When turned on, the output is muted for approximately four seconds to protect your system from start-up transients. (This delay can be changed. Contact Crown's Technical Support Group for details.)

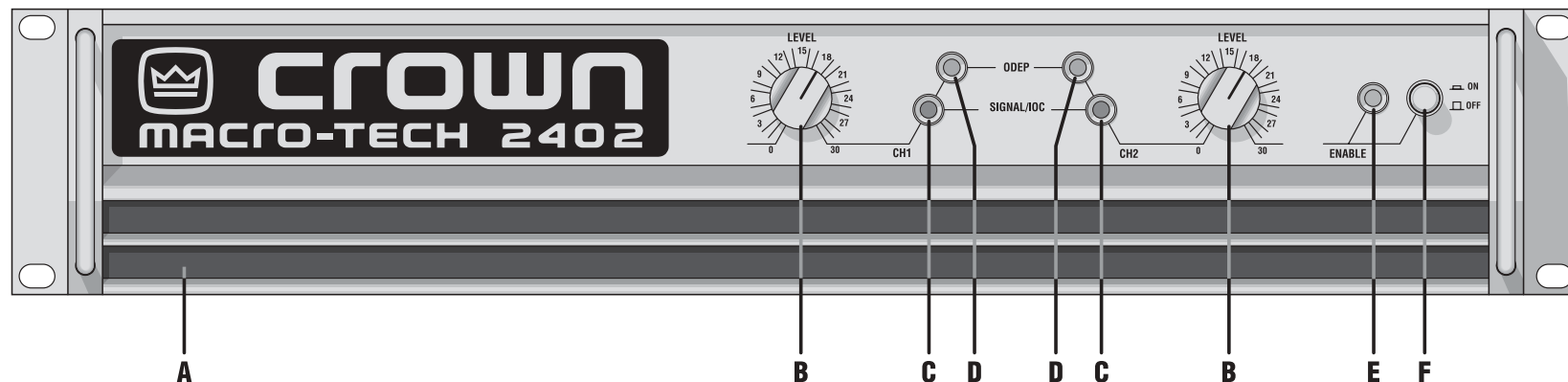

Figure 4.1 Front Panel Controls & Indicators

4 Operation

4.3 Back Panel Controls, Indicators and Connectors

G. Power Cord

The power cord has an appropriate plug for the required voltage. 120 VAC, 60 Hz North American Macro-Tech 602s and 1202s have 14 AWG line cords and NEMA 5-15P plugs. Macro-Tech 2402s have 12 AWG line cords and NEMA 5-20P plugs. International units are shipped with an appropriate line cord and plug. See Section 7 for AC power usage.

H. Stereo/Mono Switch

The three operating modes of a Macro-Tech amplifier are controlled by this switch. Stereo mode is used for normal two-channel operation, Bridge-Mono mode is used to drive a single channel with a load impedance of at least 4 ohms, and Parallel-Mono mode is used to drive a single channel with an impedance less than 4 ohms. Important: Turn off the amplifier before changing the stereo/mono switch (see Sections 3.6.2 and 3.6.3).

I. Reset Switches (Macro-Tech 2402 only)

The Macro-Tech 2402 has a back panel Reset switch for each channel. Each switch resets the circuit breaker that protects the channel's power supply from overload.

J. PIP Module

The standard PIP2-FXQ is included with your amplifier. It provides female three-pin XLR input connectors. A variety of other PIP modules can be used in place of the PIP2-FXQ. They add additional features that customize the amplifier for different applications (see Section 5.3.1 for information on available PIP modules).

Input Sensitivity Switch (not shown)

The three-position input sensitivity switch located inside the amplifier can be set after removing the PIP module (J). It is set at the factory to 0.775 volts for standard 1-kHz output into 8 ohms. It can also be set to 1.4 volts for standard 1-kHz output into 8 ohms, or a fixed voltage gain of 26 dB (see Section 3.7).

K. Balanced Phone Jack Inputs

Balanced 1/4-inch phone jack input connectors are provided on the PIP2-FXQ. The phone jacks can be wired for either balanced (tip, ring and sleeve) or unbalanced (tip and sleeve) input signals. Caution: The Channel 2 input should NOT be used in either Bridge-Mono or Parallel-Mono mode.

L. Balanced XLR Inputs

The factory-installed PIP2-FXQ provides a three-pin female XLR connector for balanced input to each channel. The XLR inputs are connected in parallel with the amplifier's phone jack inputs. Because the PIP2-FXQ does not have any active circuitry, its XLR connectors can also be used as "daisy chain" outputs to connect signals from phone jack inputs to multiple amplifiers. Caution: The Channel 2 input should NOT be used in either Bridge-Mono or Parallel-Mono mode.

M. Output Jacks

A pair of versatile 5-way binding posts is provided for the output of each channel. The 5-way binding posts accept banana plugs, spade lugs or bare wire. (European models do not accept banana plugs.)

N. Input Ground Lift Switch

The input ground lift switch is located on the PIP2-FXQ. It is used to isolate the input signal grounds from the AC (chassis) ground to help prevent ground loops that can result in unwanted hum and noise (see the *Crown Amplifier Application Guide* for more information about preventing ground loops).

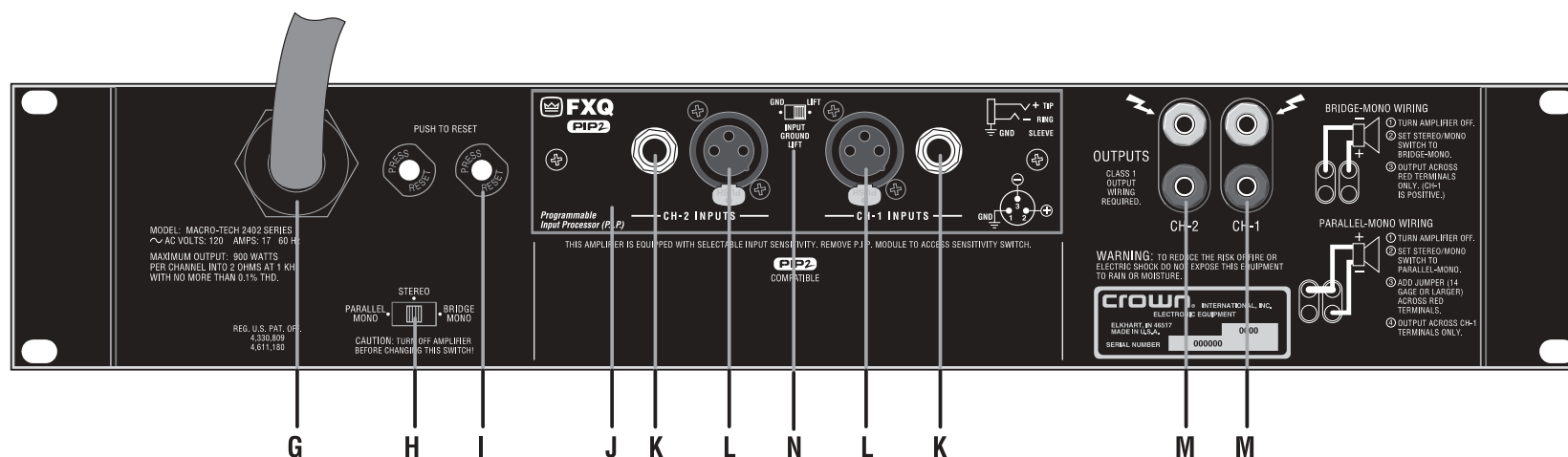

Figure 4.2 Rear Panel Controls & Connectors
(Note: Reset Switches (Item I) only available on the Macro-Tech 2402 model.)

4 Operation

4.4 Indicators

The amber **Enable indicator** is provided to show that the amplifier has been turned on (or enabled), and that its low-voltage power supply and forced-air cooling system are working. It does not indicate the status of the high-voltage power supplies. For example, the Enable indicator will remain lit during unusual conditions that would cause the amplifier's protection systems to put a high-voltage power supply in "standby" mode (see Section 5.1.2).

The amber **ODEP indicators** confirm the normal operation of Crown's patented Output Device Emulation Protection circuitry. During normal operation, they glow brightly to show the presence of reserve thermal-dynamic energy. They dim proportionally as the energy reserve decreases. In the rare event that there is no reserve, the indicators turn off and ODEP proportionally limits the drive level of the output stages so the amplifier can continue safe operation even when conditions are severe. (For a more detailed description of ODEP, see Section 5.1.1.)

The ODEP indicator for the affected channel will turn off if a high-voltage power supply is put in "standby" mode, a high-voltage power supply fuse (or breaker) blows, or a transformer activates its thermal protection circuitry (see Section 5.1.3). Both ODEP indicators turn off if the amplifier loses AC power, the power switch is turned off or the low-voltage power supply fuse blows.

The green **Signal/IOC indicators** show signal presence and distortion. As signal presence indicators, they flash with normal intensity in sync with the output audio signals. As IOC (Input/Output Comparator) indicators, they flash brightly if there is any difference between the input and output signal waveforms greater than 0.05%. Because transient distortion happens quickly, a 0.1 second "hold delay" keeps the indicators on long enough to be easily noticed. The IOC function essentially provides proof of distortion-free performance. Note: The Channel 2 IOC indicator will remain lit when running in Parallel-Mono mode.

Under conditions where one of the amplifier's high-voltage power supplies is temporarily put in standby mode, the Signal/IOC indicators will stay on with full brightness. They will resume normal operation when the amplifier is no longer in standby mode.

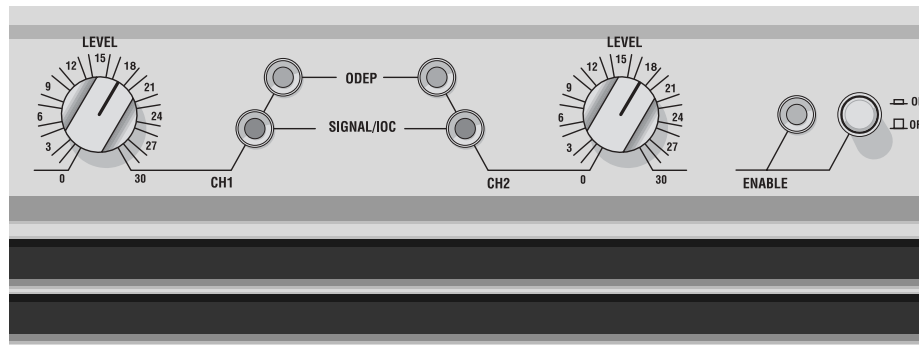

Figure 4.3 Indicators

5 Advanced Features and Options

5.1 Protection Systems

Macro-Tech amplifiers provide extensive protection and diagnostics capabilities. Protection systems include ODEP, "standby" mode, fuses (or breakers), and special thermal protection for the unit's transformers.

5.1.1 ODEP

Crown invented ODEP to solve two long-standing problems in amplifier design: to prevent amplifier shutdown during demanding operation and to increase the efficiency of the output circuitry.

To do this, Crown established a rigorous program to measure the safe operating area (SOA) of each output transistor before installing it in an amplifier. Next, Crown designed intelligent circuitry to simulate the instantaneous operating conditions of those output transistors. Its name describes what it does: Output Device Emulation Protection or ODEP. In addition to simulating the operating conditions of the output transistors, it also compares their operation to their known SOA. If it sees that more power is about to be asked of them than they are capable of delivering under the present conditions, ODEP immediately limits the drive level until it falls within the SOA. Limiting is proportional and kept to an absolute minimum—only what is required to prevent output transistor damage.

This level of protection enables Crown to increase output efficiency to never-before-achieved levels while greatly increasing amplifier reliability.

The on-board intelligence is monitored in two ways. First, the front panel ODEP indicators show whether the amplifier is functioning correctly or if ODEP is limiting the drive level. Second, ODEP data is fed to the back panel PIP connector so advanced PIP modules like the IQ-PIP-USP2 can use it to monitor and control the amplifier.

With ODEP, the show keeps going because you get the maximum power with the maximum protection.

5.1.2 Standby Mode

An important part of a Macro-Tech amplifier's protection systems is standby mode. Standby protects the amplifier during potentially catastrophic conditions. It temporarily removes bias in all four output stages, protecting the amplifier and its loads. This advanced protection implementation, called "Quad-Mute," is new to the Macro-Tech series amplifiers. Standby mode can be identified using the indicator table in Section 6, Troubleshooting.

Standby mode can be activated in several situations. First, if dangerous subsonic frequencies or direct current (DC) is detected in the amplifier's output, the unit will activate its DC/low-frequency protection circuitry and put the affected channels in standby. This protects the loads and prevent oscillations. The unit resumes normal operation as soon as the amplifier no longer detects dangerous low frequency or DC output. Although it is extremely unlikely that you will ever activate the amplifier's DC/low-frequency protection system, improper source materials such as subsonic square waves or input overloads that result in excessively clipped input signals can activate this system.

The amplifier's fault protection system will put an amplifier channel in standby mode in rare situations where heavy common-mode current is detected in the channel's output. The amplifier should never output heavy common-mode current unless its circuitry is damaged in some way, and putting a channel in standby mode helps to prevent further damage.

The amplifier's transformer thermal protection circuitry is activated in very unusual circumstances where the unit's transformer temperature rises to unsafe levels. Under these abnormal conditions, the amplifier will put the channel of the affected transformer in standby mode. The amplifier will return to normal operation after the transformer cools to a safe temperature. (For more information on transformer thermal protection, refer to section 5.1.3.)

An IQ-PIP module may also temporarily place the amplifier in standby mode, typically for power conservation. The standby mode status can be triggered either manually or through IQ's "auto standby" feature. If triggered via the IQ auto standby feature, the standby status will be automatically cancelled when the defined level of input signal is detected. However, if the standby status has been triggered manually, this status must be manually cancelled using IQ.

5.1.3 Transformer Thermal Protection

All Macro-Tech amplifiers have transformer thermal protection. It protects the power supplies from damage under the rare conditions of transformer temperatures rising too high. A thermal switch embedded in each transformer removes power to the channel if there is excessive heat. The switch automatically resets when the transformer cools to a safe temperature.

It is extremely unlikely that you will ever see a Macro-Tech amplifier activate transformer thermal protection as long as it is operated within rated conditions (see Section 8, Specifications). One reason is that ODEP keeps the amplifier working under very severe conditions. Even so, higher than rated output levels, excessively low impedance loads and unreasonably high input signals can generate more heat in the transformer than in the output devices. These conditions can overheat the transformer and activate its protection system.

Macro-Tech amplifiers are designed to keep working under conditions where other amplifiers would fail. But even when the limits of a Macro-Tech amplifier are exceeded, it will still protect itself—and your investment—from damage.

5 Advanced Features and Options

5.1.4 Fuses and Circuit Breakers

The power supplies of the Macro-Tech 602 and 1202 are protected by fuses. The power supplies of the Macro-Tech 2402 are protected by circuit breakers. With rated loads and output levels, the fuses (or circuit breakers) should only shut down the amplifier in the rare instance of a catastrophic failure. Other protection systems like ODEP keep the amplifier operational under most other severe conditions. The fuses (or circuit breakers) can also shut down the amplifier in cases where extremely low-impedance loads and high output levels result in current draw that exceeds their rating. Again, this should only be possible when operating outside rated conditions, such as when the amplifier is used to drive a 1-ohm load in Stereo mode, or when a signal overloads the input and is clipped severely.

All 120 VAC, 60 Hz units and all Macro-Tech 2402s have a separate fuse for the low-voltage power supply. All units have separate fuses or breakers for the high-voltage power supplies.

Macro-Tech amplifiers do not blow their fuses or trip their breakers unless something is wrong. In the rare event that an internal fuse blows, please refer the unit to a qualified technician. If a breaker in a Macro-Tech 2402 trips, try to identify and correct the problem before resetting the breakers with the back panel Reset switches. If the problem persists, refer the unit to a qualified technician.

5.2 Advanced Features

Macro-Tech amplifiers use cutting edge technology to deliver the ultimate in power and value for their size, weight and price. They offer numerous advantages over conventional designs and provide benefits you can't get in amplifiers from any other manufacturer.

Here are some of their many features:

- Crown's Grounded Bridge design delivers large voltage swings without using easily stressed output-transistor configurations like conventional amplifiers. The results are lower distortion and superior reliability.
- Patented ODEP (Output Device Emulation Protection) circuitry compensates for overheating and overload to keep the amplifier working when others would fail.
- IOC (Input/Output Comparator) circuitry immediately alerts of any distortion exceeding 0.05%, providing dynamic proof of distortion-free performance.
- PIP (Programmable Input Processor) connector accepts accessories that tailor the amplifier to suit specific applications.
- Enhanced PIP2 (Programmable Input Processor) connector accepts new accessory modules that further tailor the amplifier to suit specific applications, including wideband load current monitoring.
- Two mono modes (Bridge-Mono and Parallel-Mono) for driving a wide range of load impedances.
- Very low harmonic and intermodulation distortion result in the best dynamic transfer function in the industry.
- High damping factor provides superior control over low-frequency drivers for a clean, accurate low end.
- Full protection against shorted outputs, mismatched loads, input/output DC, general overheating, high-frequency overloads and internal faults.
- Dedicated power supply transformers isolate channels in Stereo mode for superb crosstalk characteristics and reliability—each channel is virtually a separate amplifier.
- Balanced inputs with internal three-position sensitivity switch and adjustable front-panel level controls.
- Full protection from shorted, open and mismatched loads, general overheating, DC, high-frequency overloads, and full internal fault protection are provided by our latest protection scheme: "Quad-Mute."
- Efficient heat sinks and a self-contained forced-air cooling system dissipate heat quickly and evenly for extra amplifier protection and greater power output.
- Extra rugged, extruded aluminum front panel with ODEP and signal presence/IOC indicators for each channel, and an Enable indicator.
- Mounts in a standard 19-inch (48.3-cm) equipment rack (units can also be stacked).
- Three-Year, No-Fault, Fully Transferable warranty completely protects your investment and guarantees its specifications.

5 Advanced Features and Options

5.3 Options

5.3.1 PIP and PIP2 Modules

Versatile PIP (Programmable Input Processor) modules provide flexible expansion features that can be added to customize the amplifier. PIP modules plug into the connector inside the back panel of the amplifier. PIP modules are available with a features ranging from error-driven compressor/limiters to IQ control. Your amplifier is a PIP2 amplifier, which means it can take advantage of the many advanced features found in PIP2 modules, as well as all standard PIP modules. Visit the Crown website at www.crownaudio.com, or contact Crown Customer Service, for descriptions of available PIP and PIP2 modules.

The modules install easily: For PIP units featuring an edge-connector, first attach the amplifier's ribbon cables to the PIP2 adapter as in Figure 5.1. Then carefully slide the PIP card edge into the adapter's edge connector (Figure 5.2). Finally, insert the combined units into the amplifier and screw securely into place (Figure 5.2).

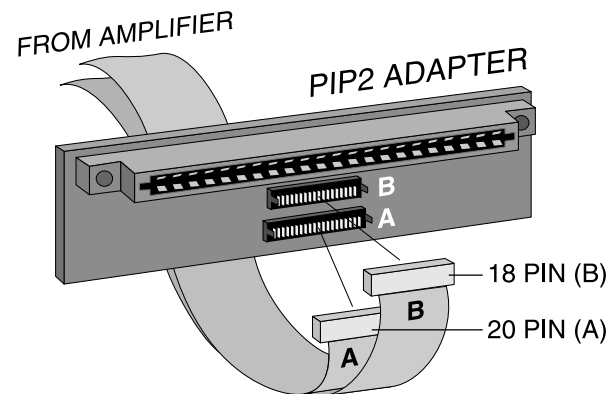

Figure 5.1 PIP2 Adapter Connection

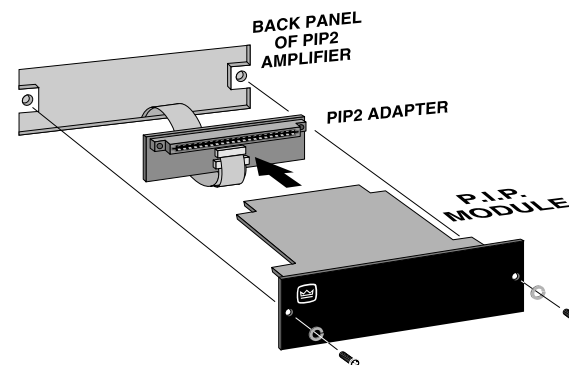
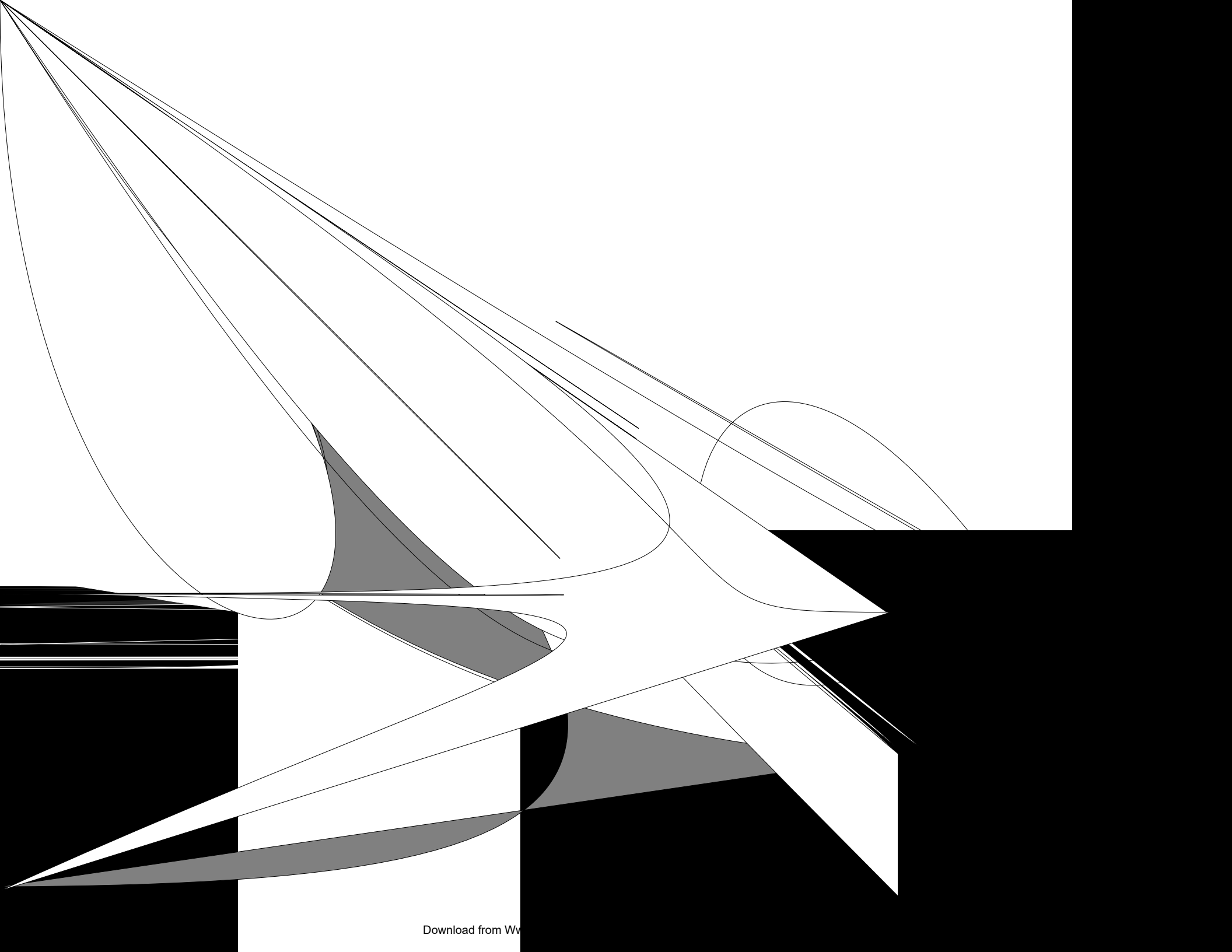













Figure 5.2 Installing a PIP Module



6 Troubleshooting

The table in Figure 6.1 shows the possible states for the ODEP and Signal/IOC indicators. It also describes the conditions that may be associated with the different indicator states. The Enable indicator will be off with the first indicator state, "There is no power to the amplifier." All other conditions in the table will occur with the Enable indicator turned on. It is important to note the possible states of the indicators in the rare event that you experience a problem. This can greatly aid in determining the source of problems. Please contact your local Crown representative or our Technical Support Group for further assistance.

Figure 6.1
Macro-Tech ODEP
and Signal/IOC Indicator Status

Indicator Status	Amplifier Condition
ODEP  OFF SIGNAL/IOC  OFF	There is no power to the amplifier and all indicators are off, including the Enable light. Possible reasons: (1) The amplifier's Enable switch is off. (2) The amplifier is not plugged into the power receptacle. (3) The AC circuit breaker has been tripped. (4) The amplifier's low-voltage power supply fuse has blown.
ODEP  ON SIGNAL/IOC  OFF	Normal operation for a channel with NO audio output. Possible reasons: (1) There is no input signal. (2) The input signal level is very low. (3) The channel's level control is turned down.
ODEP  ON SIGNAL/IOC  Normal	Normal operation for a channel with audio output. The ODEP indicator will remain at full intensity to show that there is reserve thermodynamic energy, and the Signal/IOC indicator will flash with normal intensity to show that the channel has audio output.
ODEP  ON SIGNAL/IOC  Bright	The channel's output is exceeding 0.05% distortion. The input signal level is too high and IOC is reporting either an input overload or output clipping. <p style="text-align: center;">OR</p> Channel 2 only: The amplifier is in Parallel-Mono mode. The channel 2 Signal/IOC indicator always turns on to full brightness whenever the amplifier's stereo/mono switch is set to Parallel-Mono mode.
ODEP  OFF SIGNAL/IOC  Bright	The amplifier channel is in standby mode. Possible reasons: (1) A PIP module like an IQ-P.I.P.-SMT has turned off the channel's high-voltage power supply. (2) The amplifier has just been turned on and is still in the four second turn-on delay. (3) The DC / low-frequency protection circuitry has been activated. (4) The fault protection circuitry has been activated. (5) The transformer thermal protection circuitry has been activated. <p style="text-align: center;">OR</p> A channel's fuse has blown or breaker has tripped. Transformer overload can cause a channel's internal fuse for its high-voltage supply to blow in a Macro-Tech 602 or 1202, and it can cause the channel's circuit breaker to trip in a Macro-Tech 2402. <p style="text-align: center;">OR</p> ODEP limiting has been activated. Possible reasons: (1) The amplifier's air filters are blocked and need to be cleaned. (2) There is insufficient cooling because of inadequate air flow or air that is too hot. (3) The load impedance for the channel is too low because the output is shorted or the amplifier is driving too many loudspeakers for the selected stereo/mono mode. (4) The amplifier channel is continuously being driven to very high output levels.
ODEP  OFF SIGNAL/IOC  Normal	ODEP limiting is about to begin. Possible reasons: (1) The amplifier's air filters are blocked and need to be cleaned. (2) There is insufficient cooling because of inadequate air flow or air that is too hot. (3) The load impedance for the channel is too low because the output is shorted or the amplifier is driving too many loudspeakers for the selected stereo/mono mode. (4) The amplifier channel is continuously being driven to very high output levels.

7 Theory of Operation

7.1 Overview

Your Macro-Tech amplifier incorporates several advanced technological features including real-time computer simulation of output transistor stress, low-stress output stages, an advanced heat sink embodiment and the PIP2 (Programmable Input Processor) expansion system.

Custom circuitry is incorporated to limit temperature and current to safe levels, making it highly reliable and tolerant of faults. Unlike many lesser amplifiers, it can operate at its voltage and current limits without self-destructing.

Real-time computer simulation is used to create an analogue of the junction temperature of the output transistors (hereafter referred to as "output devices"). Current is limited only when the device temperature becomes excessive (and by the minimum amount required). This patented approach is called Output Device Emulation Protection (or ODEP). It maximizes the available output power and protects against overheating—the major cause of device failure.

The amplifier is protected from all common hazards that plague high-power amplifiers including shorted, open or mismatched loads; overloaded power supplies, excessive temperature, chain-destruction phenomena, input overload and high-frequency blowups. The unit protects loudspeakers from input and output DC, as well as turn-on and turn-off transients.

The four-quadrant topology used in a Macro-Tech's grounded output stages is called the Grounded Bridge. This patented topology makes full use of the power supplies providing peak-to-peak voltages to the load that are twice the voltage seen by the output devices (see Figure 7.1).

As its name suggests, the Grounded Bridge topology is referenced to ground. Composite devices are constructed to function as gigantic NPN and PNP devices to handle currents which exceed the limits of available devices. Each output stage has two composite NPN devices and two composite PNP devices.

The devices connected to the load are referred to as "high-side NPN and PNP" and the devices connected to ground are referred to as "low-side NPN and PNP." Positive current is delivered to the load by increasing conductance simultaneously in the high-side NPN and low-side PNP stage, while synchronously decreasing conductance of the high-side PNP and low-side NPN.

The two channels may be used together to double the voltage (Bridge-Mono) or the current (Parallel-Mono) presented to the load. This feature gives you flexibility to maximize the power available to the load.

A wide bandwidth, multiloop design is used for state-of-the-art compensation. This produces ideal behavior and results in ultra-low distortion values.

Aluminum extrusions have been widely used for heat sinks in power amplifiers due to their low cost and reasonable performance. However, measured on a watts-per-pound or watts-per-volume basis, the extrusion technology doesn't perform nearly as well as the heat sink technology developed for Macro-Tech amplifiers.

Our heat sinks are fabricated from custom convoluted fin stock that provides an extremely high ratio of area to volume, or area to weight. All power devices are mounted directly to massive heat spreaders that are electrically at the Vcc potential. Electrifying the heat spreaders improves thermal performance by eliminating the insulating interface underneath the power devices. The chassis itself is even used as part of the thermal circuit to maximize utilization of the available cooling resources.

7.2 Circuit Theory

Each channel is powered by its own power transformer T100 or T200. Both channels share a common low-voltage transformer TF-1. The secondary output of T100 is full-wave rectified by D109 and is filtered by a large computer-grade capacitor. D104 through D107 provide boosted voltage to power LVAs and predrivers.

A thermal switch embedded in each transformer protects it from overheating.

The low-voltage transformer output is rectified by diodes D1, D2, D3 and D4 to generate an unregulated 24 volts. Monolithic regulators U1 and U2 provide a regulated ± 15 volts.

7.2.1 Stereo Operation

For simplicity, the discussion of Stereo operation will refer to one channel only. Mono operation will be discussed later.

Please refer to the block diagram in Figure 7.1.

The input signal at the phone jack passes directly into the balanced gain stage (U104-C and U104-D). When the PIP module is used, the input signal first passes through the PIP's circuitry and then to the balanced gain stage.

The balanced gain stage (U104-C and U104-D) causes balanced to single-ended conversion using a difference amplifier. From there, gain can be controlled with a potentiometer. The error amp (U104-A) amplifies the difference between the output signal and the input signal from the gain pot, and drives the voltage translator stage.

From the error amp U104-A, the voltage translator stage channels the signal to the Last Voltage Amplifiers (LVAs) depending on the signal polarity. The +LVA (Q104 and Q105) and the -LVA (Q110 and Q111), with their push-pull effect through the bias servo Q318, drive the fully complementary output stage.

The bias servo Q318 is thermally coupled to the heat sink, and sets the quiescent bias current in the output stage to lower the distortion in the crossover region of the output signal. Depending on the polarity of the output signal, D301, D302, D303 and D304 are used to remove the charge on the unused portion of the output stage.

With the voltage swing provided by the LVAs, the signal then gains current amplification through the Darlington emitter-follower output stage.

7 Theory of Operation

The bridge-balanced circuit (U104-B) receives a signal from the output of the amplifier, and differences it with the signal at the Vcc supply. The bridge-balanced circuit then develops a voltage to drive the bridge-balanced output stage. This results in the Vcc supply having exactly one half of the output voltage added to their quiescent voltage. D309, D310, D311 and a trimmer resistor set the quiescent current point for the bridge-balanced output stage.

The protection mechanisms that affect the signal path are implemented to protect the amplifier under real-world conditions. These conditions are high instantaneous current, excessive temperature, and output device operation outside safe conditions.

Q107 and Q108 sense current in the output stage and act as a conventional current limiter. When current at any one instant exceeds the design criteria, the limiters remove the drive from the LVAs, thus limiting current in the output stage to a safe level.

To further protect the output stages, the patented ODEP circuitry is used. It produces an analog output proportional to the always-changing safe operating area of the output transistor. This output controls the translator stage previously mentioned, removing any further drive that may exceed the safe operating area of the output stage.

Thermal sensor S100 gives the ODEP circuits vital information on the operating temperature of the heat sink on which the output devices are mounted.

Should the amplifier fail in such a way that would cause DC across the output leads, the DC protection circuit senses this on the negative feedback loop and shuts down the power supply until the DC is removed.

7.2.2 Bridge-Mono Operation

By setting the back panel stereo/mono switch to Bridge-Mono, the user can convert the Macro-Tech into a bridged, single-channel amplifier. With a sig-

nal applied to the Channel 1 input jack and the load connected across the red (+) back panel 5-way binding posts, twice the voltage can be output.

The Channel 1 output feeds the Channel 2 error amp U204-A. Because there is a net inversion, the channel 2 output is out of polarity with Channel 1. This produces twice as much voltage across the load. Each of the channel's protection mechanisms work independently if a fault occurs.

7.2.3 Parallel-Mono Operation

With the stereo/mono switch set to Parallel-Mono, the output of Channel 2 is paralleled with the output of Channel 1. A suitable jumper capable of handling high current levels must be connected across the red (+) 5-way binding posts to gain the benefits of this mode of operation.

The signal path for Channel 1 is the same as previously discussed, except Channel 1 also drives the

output stage of Channel 2. The Channel 2 balanced input, error amp, translators and LVAs are disconnected and no longer control the Channel 2 output stage. Disconnecting the front-end stages from the Channel 2 output causes the Channel 2 IOC circuit to note that the input waveform (which is not present) does not match the output waveform (which is driven by the Channel 1 input signal). This activates the Channel 2 IOC indicator any time the amplifier is switched to Parallel-Mono. The Channel 2 output stage and protection mechanisms are also coupled through S1 and function as one.

In Parallel-Mono mode, twice the current of one channel alone can be obtained. Because the Channel 2 ODEP circuit is coupled through S1, this gives added protection if a fault occurs in the Channel 2 output stage. The ODEP circuit of Channel 2 will limit the output of both output stages by removing the drive from the Channel 1 translator stages.

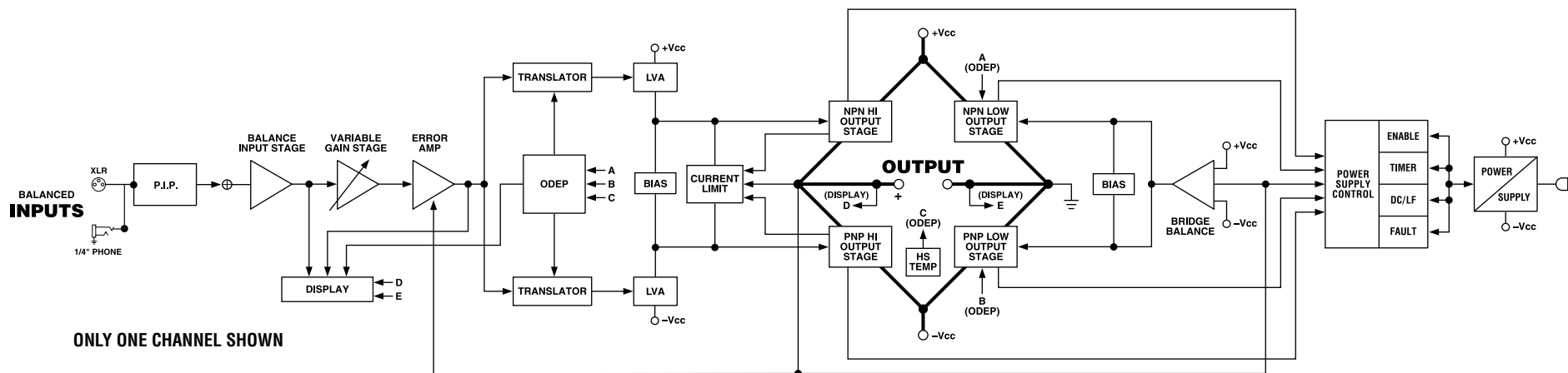

Figure 7.1 Circuit Block Diagram

8 Specifications

Minimum Guaranteed Power	Macro-Tech 602	Macro-Tech 1202	Macro-Tech 2402
120 VAC, 60 Hz Units, Stereo mode, per channel, both channels driven			
1 kHz with 0.1% THD			
Stereo, 2 ohms per ch.	400 W	675 W	1,050 W
Stereo, 4 ohms per ch.	325 W	480 W	800 W
Stereo, 8 ohms per ch.	225 W	310 W	520 W
120 VAC, 60 Hz Units, Bridge mono mode			
1 kHz with 0.1% THD			
4 ohms	750 W	1,300 W	2,070 W
8 ohms	655 W	970 W	1,585 W
16 ohms	450 W	620 W	1,035 W
120 VAC, 60 Hz Units, Parallel mono mode			
1 kHz with 0.1% THD			
1 ohm	700 W	1,300 W	2,080 W
2 ohms	665 W	965 W	1,605 W
4 ohms	450 W	620 W	1,035 W
Performance	Macro-Tech 602	Macro-Tech 1202	Macro-Tech 2402
Frequency Response (at 1 watt, 20 Hz - 20 kHz)	± 0.1 dB	± 0.1 dB	± 0.1 dB
Phase Response (at 1 watt, 10 Hz - 20 kHz)	± 10°	± 10°	± 10°
Signal to Noise Ratio below rated full bandwidth power			
20 Hz to 20 kHz	> 100 dB	> 100 dB	> 100 dB
A-weighted	> 105 dB	> 105 dB	> 105 dB
Total Harmonic Distortion (THD) at rated power, from 20 Hz to 1 kHz	< 0.05%	< 0.05%	< 0.05%
Total Harmonic Distortion (THD) at rated power, at 20 kHz	0.1%	0.1%	0.1%
Intermodulation Distortion (IMD) 60 Hz and 7 kHz at 4:1, from 163 milliwatts to full bandwidth power	< 0.05%	< 0.05%	< 0.05%
Damping Factor: 10 Hz to 400 Hz	> 1000	> 1000	> 1000
Crosstalk (below rated power, 20 Hz to 1 kHz)	> 85dB	> 85 dB	> 85 dB
Controlled Slew Rate	> 13 volts/microsecond	> 13 volts/microsecond	> 13 volts/microsecond
Input Impedance (nominal) balanced, unbalanced	20 k ohms, 10 k ohms	20 k ohms, 10 k ohms	20 k ohms, 10 k ohms

8 Specifications

Performance (continued)	Macro-Tech 602	Macro-Tech 1202	Macro-Tech 2402
Load Impedance (Note: Safe with all types of loads)			
Stereo	2-8 ohms	2-8 ohms	2-8 ohms
Bridge Mono	4-16 ohms	4-16 ohms	4-16 ohms
Parallel Mono	1-4 ohms	1-4 ohms	1-4 ohms
Voltage Gain (at maximum level setting, $\pm 6\%$)			
0.775V sensitivity	35 dB \pm 0.5 dB	36 dB \pm 0.5 dB	38 dB \pm 0.5 dB
1.4V sensitivity	30 dB \pm 0.5 dB	31 dB \pm 0.5 dB	33 dB \pm 0.5 dB
26 dB gain	26 dB	26 dB	26 dB
Required AC Mains	50/60 Hz, 100-240VAC (+10%, -15%)	50/60 Hz, 100-240VAC (+10%, -15%)	50/60 Hz, 100-240VAC (+10%, -15%)
Power Draw at Idle	100 watts or less	100 watts or less	100 watts or less
Ventilation	Flow-through ventilation from front to side panels	Flow-through ventilation from front to side panels	Flow-through ventilation from front to side panels
Cooling	Internal heat sinks with forced-air cooling-for rapid, uniform heat dissipation	Internal heat sinks with forced-air cooling for rapid, uniform heat dissipation	Internal heat sinks with forced-air cooling for rapid, uniform heat dissipation
Dimensions			
Width	EIA Standard 19-inch (48.3 cm) rack mount (EIA RS-310-B)	EIA Standard 19-inch (48.3 cm) rack mount (EIA RS-310-B)	EIA Standard 19-inch (48.3 cm) rack mount (EIA RS-310-B)
Height	3.5 inches (8.9 cm)	3.5 inches (8.9 cm)	3.5 inches (8.9 cm)
Depth	16 inches (40.6 cm)	16 inches (40.6 cm)	16 inches (40.6 cm)
Weight			
Net Weight	39 lb 9 oz (17.9 kg)	44 lb 1 oz (20.0 kg)	51 lb 12 oz (23.5 kg)
Shipping Weight	44 lb (19.9 kg)	47 lb (21.3 kg)	65 lb (29.5 kg)

8 Specifications

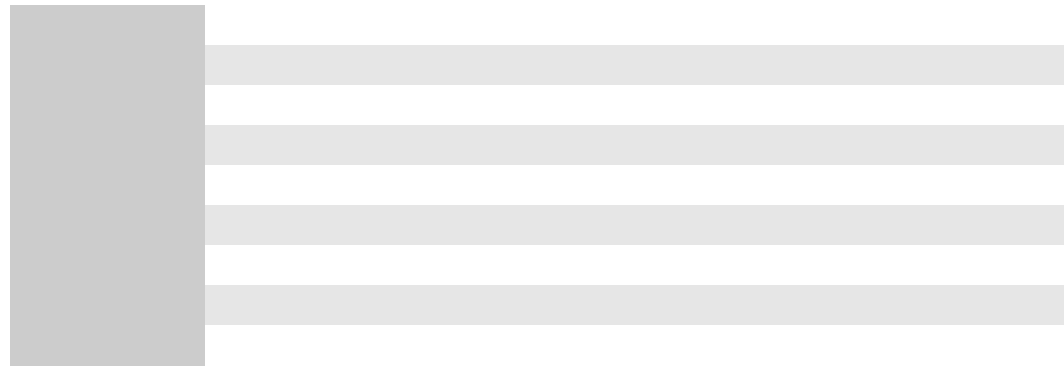

Figure 8.2 Macro-Tech 1202 Maximum Power Matrix

065

ov manu

8 Specifications

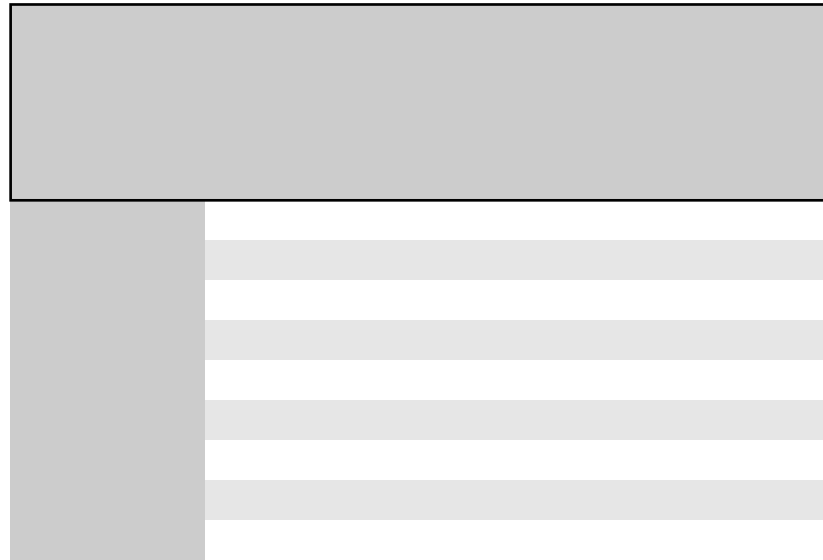

Figure 8.4 Macro-Tech 602 Minimum Power Matrix

8 Specifica

8 Specifications

Macro-Tech 2402 – Minimum Guaranteed Power (Watts)		
Stereo-Mono	Mo	
		2
		8

Figure 8.6 Macro-Tech 2402 Minimum Power Matrix

9 AC Power Draw and Thermal Dissipation

This section provides detailed information about the amount of power and current drawn from the AC mains by Macro-Tech 602, 1202 and 2402 amplifiers and the amount of heat produced under various conditions. The calculations presented here are intended to provide a realistic and reliable depiction of the amplifiers. The following assumptions or approximations were made:

- The amplifier's available channels are loaded, and full power is being delivered.
- Amplifier efficiency at standard 1 kHz power is estimated to be 65%.
- Quiescent power draw is 90 watts (an almost negligible amount for full-power calculations).
- Quiescent thermal dissipation equals 105btu/hr at 90 watts.
- The estimated duty cycles take into account the typical crest factor for each type of source material.
- Duty cycle of pink noise is 50%.
- Duty cycle of highly compressed rock 'n' roll midrange is 40%.
- Duty cycle of rock 'n' roll is 30%.
- Duty cycle of background music is 20%.
- Duty cycle of continuous speech is 10%.
- Duty cycle of infrequent, short duration paging is 1%.

Here are the equations used to calculate the data presented in Figures 9.1, 9.2 and 9.3:

$$\text{AC Mains Power Draw (watts)} = \frac{\text{Total output power with all channels driven (watts)} \times \text{Duty Cycle}}{\text{Amplifier Efficiency (.65)}} + \text{Quiescent Power Draw (watts)}$$

The quiescent power draw of 90 watts is a maximum value and includes power drawn by the fan. The following equation converts power draw in watts to current draw in amperes:

$$\text{Current Draw (amperes)} = \frac{\text{AC Mains Power Draw (watts)}}{\text{AC Mains Voltage} \times \text{Power Factor (.83)}}$$

The power factor of 0.83 is needed to compensate for the difference in phase between the AC mains voltage and current. The following equation is used to calculate thermal dissipation:

$$\text{Thermal Dissipation (btu/hr)} = \left(\frac{\text{Total output power with all channels driven (watts)} \times \text{Duty Cycle}}{\text{Amplifier Efficiency (.65)}} + \text{Quiescent Power Draw (watts)} \right) \times 3.415$$

The constant 0.35 is inefficiency (1.00–0.65) and the factor 3.415 converts watts to btu/hr. Thermal dissipation in btu is divided by the constant 3.968 to get kcal. If you plan to measure output power under real-world conditions, the following equation may also be helpful:

9 AC Power Draw and Thermal Dissipation

Macro-Tech 602

Duty Cycle	L O A D														
	AC Mains Power Draw (Watts)	8 Ohm Stereo				AC Mains Power Draw (Watts)	4 Ohm Stereo / 8 Ohm Bridge-Mono / 2 Ohm Parallel-Mono				AC Mains Power Draw (Watts)	2 Ohm Stereo / 4 Ohm Bridge-Mono / 1 Ohm Parallel-Mono			
		Current Draw (Amps)		Thermal Dissipation			Current Draw (Amps)		Thermal Dissipation			Current Draw (Amps)		Thermal Dissipation	
100-120 V	220-240 V	btu/hr	kcal	100-120 V	220-240 V	btu/hr	kcal	100-120 V	220-240 V	btu/hr	kcal				
50%	450	4.5	2.3	740	185	615	6.1	3.1	930	235	720	7.2	3.6	1060	265
40%	380	3.8	1.9	655	165	510	5.1	2.6	805	205	595	6.0	3.0	910	230
30%	305	3.1	1.6	565	140	405	4.0	2.0	680	170	470	4.7	2.4	760	190
20%	235	2.4	1.2	480	120	300	3.0	1.5	560	140	340	3.4	1.7	610	155
10%	160	1.6	0.8	395	100	195	1.9	1.5	435	110	215	2.2	1.1	460	115

Figure 9.1 Macro-Tech 602 Power Draw, Current Draw and Thermal Dissipation at Various Duty Cycles

Macro-Tech 1202

Duty Cycle	L O A D														
	AC Mains Power Draw (Watts)	8 Ohm Stereo				AC Mains Power Draw (Watts)	4 Ohm Stereo / 8 Ohm Bridge-Mono / 2 Ohm Parallel-Mono				AC Mains Power Draw (Watts)	2 Ohm Stereo / 4 Ohm Bridge-Mono / 1 Ohm Parallel-Mono			
		Current Draw (Amps)		Thermal Dissipation			Current Draw (Amps)		Thermal Dissipation			Current Draw (Amps)		Thermal Dissipation	
100-120 V	220-240 V	btu/hr	kcal	100-120 V	220-240 V	btu/hr	kcal	100-120 V	220-240 V	btu/hr	kcal	100-120 V	220-240 V	btu/hr	kcal
50%	580	5.8	2.9	895	225	850	8.5	4.3	1220	310	1165	11.7	5.9	1595	400
40%	485	4.8	2.4	780	195	700	7.0	3.5	1035	260	950	9.5	4.8	1335	335
30%	385	3.9	2.0	660	165	545	5.5	2.8	855	215	735	7.4	3.7	1080	270
20%	285	2.9	1.5	545	135	395	3.9	2.0	670	170	520	5.2	2.6	820	205
10%	190	1.9	1.0	425	105	240	2.4	1.2	490	125	305	3.1	1.6	565	140

Figure 9.2 Macro-Tech 1202 Power Draw, Current Draw and Thermal Dissipation at Various Duty Cycles

Macro-Tech 2402

Duty Cycle	L O A D														
	AC Mains Power Draw (Watts)	8 Ohm Stereo				AC Mains Power Draw (Watts)	4 Ohm Stereo / 8 Ohm Bridge-Mono / 2 Ohm Parallel-Mono				AC Mains Power Draw (Watts)	2 Ohm Stereo / 4 Ohm Bridge-Mono / 1 Ohm Parallel-Mono			
		Current Draw (Amps)		Thermal Dissipation			Current Draw (Amps)		Thermal Dissipation			Current Draw (Amps)		Thermal Dissipation	
100-120 V	220-240 V	btu/hr	kcal	100-120 V	220-240 V	btu/hr	kcal	100-120 V	220-240 V	btu/hr	kcal	100-120 V	220-240 V	btu/hr	kcal
50%	890	8.9	4.5	1265	320	1320	13.2	6.6	1780	450	1780	17.8	8.9	2330	585
40%	730	7.3	3.7	1070	270	1075	10.8	5.4	1485	375	1445	14.4	7.2	1925	485
30%	570	5.7	2.9	880	220	830	8.3	4.2	1190	300	1105	11.1	5.6	1520	385
20%	410	4.1	2.1	690	175	580	5.8	2.9	895	225	765	7.7	3.9	1115	280
10%	250	2.5	1.3	500	125	335	3.4	1.7	600	150	430	4.3	2.2	710	180

Figure 9.3 Macro-Tech 2402 Power Draw, Current Draw and Thermal Dissipation at Various Duty Cycles

10 Service

Crown amplifiers are quality units that rarely require servicing. Before returning your unit for servicing, please contact Crown Factory Service to verify the need for servicing.

This unit has very sophisticated circuitry which should only be serviced by a fully trained technician. This is one reason why each unit bears the following label:



CAUTION: To prevent electric shock, do not remove covers. No user serviceable parts inside. Refer servicing to a qualified technician.

10.1 Worldwide Service

Service may be obtained from an authorized service center. (Contact your local Crown/Amcron representative or our office for a list of authorized service centers.) To obtain service, simply present the bill of sale as proof of purchase along with the defective unit to an authorized service center. They will handle the necessary paperwork and repair.

Remember to transport your unit in the original factory pack.

10.2 US and Canada Service

Service may be obtained in one of two ways: from an authorized service center or from the factory. You may choose either. It is important that you have your copy of the bill of sale as your proof of purchase.

10.2.1 Service at a US or Canada Service Center

This method usually saves the most time and effort. Simply present your bill of sale along with the defective unit to an authorized service center to obtain service. They will handle the necessary paperwork and repair. Remember to transport the unit in the original factory pack. A list of authorized service centers in your area can be obtained from Crown Factory Service or the Crown website at www.crownaudio.com.

10.2.2 Factory Service

To obtain factory service, fill out the service information page found in the back of this manual and send it along with your proof of purchase and the defective unit to the Crown factory.

For warranty service, we will pay for ground shipping both ways in the United States. Contact Crown Factory Service to obtain prepaid shipping labels prior to sending the unit. Or, if you prefer, you may prepay the cost of shipping, and Crown will reimburse you. Send copies of the shipping receipts to Crown Factory Service to receive reimbursement.

Your repaired unit will be returned via UPS ground. Please contact us if other arrangements are required.

10.2.3 Factory Service Shipping Instructions:

1. Before sending a Crown product to the factory for service, first call Crown Factory Service for a return authorization (RA) number.
2. Be sure to fill out the service information form that follows and enclose it with your shipment, either inside the box or in a packing slip envelope securely attached to the outside of the shipping carton. Do not send the service information form separately.
3. To ensure the safe transportation of your unit to the factory, ship it in an original factory packing container. If you don't have the original carton, you may obtain a product service foam-in-place shipping pack from the Crown Factory Service Department at the number listed below. For non-warranty service, you may also provide your own shipping pack. Minimum recommended requirements for materials are as follows: 275 P.S.I. burst test Double-Wall

carton that allows for 2-inch solid Styrofoam on all six sides of unit or 3 inches of plastic bubble wrap on all six sides of unit; securely seal the package with an adequate carton sealing tape. Do not use light boxes or "peanuts." Damage caused by poor packing cannot be covered under warranty.

4. Do not ship the unit in any kind of cabinet (wood or metal). Ignoring this warning may result in extensive damage to the unit and the cabinet. Accessories are not needed—do not send the product documentation, cables and other hardware.

If you have any questions, please call or write Crown Factory Service.

Crown Factory Service

1718 W. Mishawaka Rd.,
Elkhart, Indiana 46517 U.S.A.

Telephone: 574-294-8200
800-342-6939 (North America,
Puerto Rico, and Virgin Islands only)

Facsimile:
574-294-8301 (Technical Support)
574-294-8124 (Factory Service)

Internet:
<http://www.crownaudio.com>

11 Warranty



SUMMARY OF WARRANTY

Crown International, 1718 West Mishawaka Road, Elkhart, Indiana 46517-4095 U.S.A. warrants to you, the ORIGINAL PURCHASER and ANY SUBSEQUENT OWNER of each NEW Crown product, for a period of three (3) years from the date of purchase by the original purchaser (the "warranty period") that the new Crown product is free of defects in materials and workmanship. We further warrant the new Crown product regardless of the reason for failure, except as excluded in this Warranty.

ITEMS EXCLUDED FROM THIS CROWN WARRANTY

This Crown Warranty is in effect only for failure of a new Crown product which occurred within the Warranty Period. It does not cover any product which has been damaged because of any intentional misuse, accident, negligence, or loss which is covered under any of your insurance contracts. This Crown Warranty also does not extend to the new Crown product if the serial number has been defaced, altered, or removed.

WHAT THE WARRANTOR WILL DO

We will remedy any defect, regardless of the reason for failure (except as excluded), by repair, replacement, or refund. We may not elect refund unless you agree, or unless we are unable to provide replacement, and repair is not practical or cannot be timely made. If a refund is elected, then you must make the defective or malfunctioning product available to us free and clear of all liens or other encumbrances. The refund will be equal to the actual purchase price, not including inter-

UNITED STATES & CANADA

est, insurance, closing costs, and other finance charges less a reasonable depreciation on the product from the date of original purchase. Warranty work can only be performed at our authorized service centers or at the factory. Warranty work for some products can only be performed at our factory. We will remedy the defect and ship the product from the service center or our factory within a reasonable time after receipt of the defective product at our authorized service center or our factory. All expenses in remedying the defect, including surface shipping costs in the United States, will be borne by us. (You must bear the expense of shipping the product between any foreign country and the port of entry in the United States including the return shipment, and all taxes, duties, and other customs fees for such foreign shipments.)

HOW TO OBTAIN WARRANTY SERVICE

You must notify us of your need for warranty service within the warranty period. All components must be shipped in a factory pack, which, if needed, may be obtained from us free of charge. Corrective action will be taken within a reasonable time of the date of receipt of the defective product by us or our authorized service center. If the repairs made by us or our authorized service center are not satisfactory, notify us or our authorized service center immediately.

DISCLAIMER OF CONSEQUENTIAL AND INCIDENTAL DAMAGES

YOU ARE NOT ENTITLED TO RECOVER FROM US ANY INCIDENTAL DAMAGES RESULTING

FROM ANY DEFECT IN THE NEW CROWN PRODUCT. THIS INCLUDES ANY DAMAGE TO ANOTHER PRODUCT OR PRODUCTS RESULTING FROM SUCH A DEFECT. SOME STATES DO NOT ALLOW THE EXCLUSION OR LIMITATIONS OF INCIDENTAL OR CONSEQUENTIAL DAMAGES, SO THE ABOVE LIMITATION OR EXCLUSION MAY NOT APPLY TO YOU.

WARRANTY ALTERATIONS

No person has the authority to enlarge, amend, or modify this Crown Warranty. This Crown Warranty is not extended by the length of time which you are deprived of the use of the new Crown product. Repairs and replacement parts provided under the terms of this Crown Warranty shall carry only the unexpired portion of this Crown Warranty.

DESIGN CHANGES

We reserve the right to change the design of any product from time to time without notice and with no obligation to make corresponding changes in products previously manufactured.

LEGAL REMEDIES OF PURCHASER

THIS CROWN WARRANTY GIVES YOU SPECIFIC LEGAL RIGHTS, YOU MAY ALSO HAVE OTHER RIGHTS WHICH VARY FROM STATE TO STATE. No action to enforce this Crown Warranty shall be commenced after expiration of the warranty period.

THIS STATEMENT OF WARRANTY SUPERSEDES ANY OTHERS CONTAINED IN THIS MANUAL FOR CROWN PRODUCTS. 7/01

SUMMARY OF WARRANTY

Crown International, 1718 West Mishawaka Road, Elkhart, Indiana 46517-4095 U.S.A. warrants to you, the ORIGINAL PURCHASER and ANY SUBSEQUENT OWNER of each NEW Crown1 product, for a period of three (3) years from the date of purchase by the original purchaser (the "warranty period") that the new Crown product is free of defects in materials and workmanship, and we further warrant the new Crown product regardless

11 Warranty



of the reason for failure, except as excluded in this Warranty.

¹ Note: If your unit bears the name "Amcron," please substitute it for the name "Crown" in this warranty.

ITEMS EXCLUDED FROM THIS CROWN-WARRANTY

This Crown Warranty is in effect only for failure of a new Crown product which occurred within the Warranty Period. It does not cover any product which has been damaged because of any intentional misuse, accident, negligence, or loss which is covered under any of your insurance contracts. This Crown Warranty also does not extend to the new Crown product if the serial number has been defaced, altered, or removed.

WHAT THE WARRANTOR WILL DO

We will remedy any defect, regardless of the reason for failure (except as excluded), by repair, replacement, or refund. We may not elect refund unless you agree, or unless we are unable to provide replacement, and repair is not practical or cannot be timely made. If a refund is elected, then you must make the defective or malfunctioning product available to us free and clear of all liens or other encumbrances. The refund will be equal to the actual purchase price, not including interest, insurance, closing costs, and other finance charges less a reasonable depreciation on the product from the date of original purchase. War-

WORLDWIDE EXCEPT USA & CANADA

ranty work can only be performed at our authorized service centers. We will remedy the defect and ship the product from the service center within a reasonable time after receipt of the defective product at our authorized service center.

HOW TO OBTAIN WARRANTY SERVICE

You must notify your local Crown importer of your need for warranty service within the warranty period. All components must be shipped in the original box. Corrective action will be taken within a reasonable time of the date of receipt of the defective product by our authorized service center. If the repairs made by our authorized service center are not satisfactory, notify our authorized service center immediately.

DISCLAIMER OF CONSEQUENTIAL AND INCIDENTAL DAMAGES

YOU ARE NOT ENTITLED TO RECOVER FROM US ANY INCIDENTAL DAMAGES RESULTING FROM ANY DEFECT IN THE NEW CROWN PRODUCT. THIS INCLUDES ANY DAMAGE TO ANOTHER PRODUCT OR PRODUCTS RESULTING FROM SUCH A DEFECT.

WARRANTY ALTERATIONS

No person has the authority to enlarge, amend, or

modify this Crown Warranty. This Crown Warranty is not extended by the length of time which you are deprived of the use of the new Crown product. Repairs and replacement parts provided under the terms of this Crown Warranty shall carry only the unexpired portion of this Crown Warranty.

DESIGN CHANGES

We reserve the right to change the design of any product from time to time without notice and with no obligation to make corresponding changes in products previously manufactured.

LEGAL REMEDIES OF PURCHASER

No action to enforce this Crown Warranty shall be commenced after expiration of the warranty period.

THIS STATEMENT OF WARRANTY SUPERSEDES ANY OTHERS CONTAINED IN THIS MANUAL FOR CROWN PRODUCTS. 12/01

NOTES



Crown Factory Service Information

Shipping Address: Crown Factory Service, 1718 W. Mishawaka Rd., Elkhart, IN 46517

Phone: 1-800-342-6939 or 1-574-294-8200 Fax: 1-574-294-8124

Owner's Name : _____

Shipping Address: _____

Phone Number: _____ Fax Number: _____

Model: _____ Serial Number: _____

Purchase Date : _____

NATURE OF PROBLEM

(Be sure to describe the conditions that existed when the problem occurred and what attempts were made to correct it.)

Other equipment in system: _____

If warranty has expired, payment will be: Cash/Check VISA MasterCard C.O.D. P.O. from Crown Dealer.

Card Number: _____ Exp. Date: _____

Signature: _____

ENCLOSE THIS PORTION WITH THE UNIT. DO NOT MAIL SEPARATELY.



H A Harman International Company

Free Manuals Download Website

<http://myh66.com>

<http://usermanuals.us>

<http://www.somanuals.com>

<http://www.4manuals.cc>

<http://www.manual-lib.com>

<http://www.404manual.com>

<http://www.luxmanual.com>

<http://aubethermostatmanual.com>

Golf course search by state

<http://golfingnear.com>

Email search by domain

<http://emailbydomain.com>

Auto manuals search

<http://auto.somanuals.com>

TV manuals search

<http://tv.somanuals.com>