

# Recipe Booklet

From fabulous recipes to family favorites –  
warm fresh bread whenever you want it!

Instruction  
Booklet  
Reverse Side



**Cuisinart**<sup>™</sup>  
CONVECTION BREAD MAKER



## **Get ready to enjoy warm, fresh, homemade bread whenever you want it!**

Your new Cuisinart™ Convection Bread Maker makes it easy – it will make luscious bread from raw ingredients to finished loaf, or prepare enough dough for artisan and specialty breads for baking in a traditional oven. It even lets you set the finish time for some breads up to 12 hours in advance. Decide which of our fabulous recipes you want to try, or use a family favorite. Then just add ingredients and select a menu option, crust color and loaf size.

We'll do the rest! We've included recipes for our Low-Carb and Gluten-Free menu options, as well as a variety of other breads, doughs and jams.

# Contents

## White/Rapid White Bread Cycle

Basic White Bread-Machine Bread 1 / Oatmeal Bread 2 / Cinnamon Swirl Bread 3 / Granola Bread 4 / Rosemary Bread 5 / Pesto Bread 6 / Blue Cheese and Olive Bread 7 / Sun-Dried Tomato and Mozzarella Bread 8 / Beer Bread 9 / Potato Bread 10 / Three-Cheese Bread 11

## Whole Wheat/Rapid Whole Wheat Bread Cycle

Basic Honey Whole Wheat Bread 12 / Buttermilk Whole Wheat Bread 13 / Multi-Grain Cereal Wheat Bread 14 / Nutty Whole Wheat Bread 15 / True 100% Whole Wheat Bread 16 / Whole Grain Whole Wheat Bread 17 / Wheat Bran Bread 18 / Pumpnickel Raisin Bread 19 / Gruyère and Walnut Wheat Bread 21

## French/Italian/Rapid French/Italian Bread Cycle

French Bread Loaf 22 / Rustic Italian Loaf 23 / Country French with Olives and Rosemary 24 / Herbed Dill French Bread 26 / Parmesan Peppercorn French Bread 27 / Pignoli Bread 28 / Seminola Bread with Fennel and Golden Raisins 29

## Quick Bread/Cake Cycle

Banana Walnut Loaf 30 / Carrot Cake Bread 31 / Date Nut Bread 32 / Lemon Poppy Seed Bread 33 / Pumpkin Walnut Bread 34 / Sour Cream Chocolate Tea Loaf 35 / Zucchini Bread 36

## Low-Carb Cycle

Nutty Low-Carb Bread 37 / Low-Carb Buttermilk Bread 38 / Low-Carb Cinnamon Bread 39 / Low-Carb Molasses Bread 40 / Low-Carb Seed Bread 41 / Lower-Carb Bacon and Cheese Bread 42

## Gluten-Free Cycle

Cheesy Gluten-Free Loaf 43 / Gluten-Free Apple, Cheddar, Walnut Bread 44 / Gluten-Free Hazelnut Bread 45 / Gluten-Free Molasses Walnut Bread 46 / Gluten-Free Nut and Seed Bread 47 / Gluten-Free Rye Bread 48

## Dough/Pizza Dough Cycle

French Bread Baguettes 49 / Bread-Machine Brioche 50 / Cheddar Breadsticks 51 / Sweet Potato Cloverleaf Rolls 52 / Molasses Whole Wheat Rolls with Currants and Pecans 53 / Pizza Dough 54 / Herb Focaccia 55 / Soft Pretzels 56 / Whole Wheat Kalamata Bread 57 / Garlic, Herb, and Cheese Knots 58 / Onion Rye Rolls 59 / Peanut Butter and Chocolate Rolls 60 / Cinnamon Swirl Rolls 61 / Cream Cheese Frosting 62 / Basic Sweet Dough 63 / Apricot Cheese Danish Braid 64

## Artisan Dough Cycle

Rustic Baguette 65 / Artisan Focaccia/Pizza 66 / Buttermilk Whole Wheat Walnut Boule 67 / Cranberry Pistachio Boule 69 / Hazelnut and Apricot Artisan Loaf 70 / Seminola Loaf 71

## Sweet Breads Cycle

Challah Loaf 72 / Panettone Loaf 73 / Rich Raisin Loaf 74 / Stollen Loaf 75 / Sally Lunn Bread 76 / "Apple Pie" Bread 77 / "Chocolate Chip Cookie" Bread 78

## Jams, Sauces, Chutneys

Cranberry Sauce 79 / "Berried" Applesauce 79 / Tomato Chutney 80 / Tart Pink Grapefruit Marmalade 80 / Peach, Mango, Papaya and Apricot Jam 81 / Strawberry Rhubarb Jam 81 / Pear and Ginger Preserves 82 / Blueberry Lime Jam 82 / Plum Cassis Jam 83 / Cherry Bounce Jam 83

## Last-Minute Loaves

Tips and Hints 84 / Last-Minute White Loaf 85 / Last-Minute "Pesto" Loaf 86 / Salsa and Cheese Last-Minute Loaf 87 / Last-Minute Corn Loaf 88 / Last-Minute Cinnamon Raisin Yogurt Bread 89

# Basic White Bread-Machine Bread

White Bread Cycle  
Delay Start Timer - Yes

<b>Ingredients</b>	<b>Large – 2 pounds</b>	<b>Medium – 1½ pounds</b>	<b>Small – 1 pound</b>
<b>Water, 80°–90°F</b>	<b>1½ cups</b>	<b>1⅞ cups</b>	<b>¾ cup</b>
<b>Unsalted butter, ½-inch pieces at room temperature</b>	<b>3 tablespoons</b>	<b>2 tablespoons + 1 teaspoon</b>	<b>1½ tablespoons</b>
<b>Granulated sugar or honey</b>	<b>3 teaspoons</b>	<b>2¼ teaspoons</b>	<b>1½ teaspoons</b>
<b>Salt</b>	<b>1½ teaspoons</b>	<b>1⅞ teaspoons</b>	<b>¾ teaspoon</b>
<b>Bread flour</b>	<b>4 cups</b>	<b>3 cups</b>	<b>2 cups</b>
<b>Nonfat dry milk</b>	<b>¼ cup</b>	<b>3 tablespoons</b>	<b>2 tablespoons</b>
<b>Yeast, active dry, instant or bread machine</b>	<b>2 teaspoons</b>	<b>1½ teaspoons</b>	<b>1 teaspoon</b>

Place all ingredients, in the order listed, in the bread pan fitted with the kneading paddle. Place the bread pan in the Cuisinart™ Convection Bread Maker. Press Menu and select White. Press Crust and select Medium (or to taste). Press Loaf and select dough size. Press Start to mix, knead, rise, and bake. When pause signal sounds, remove dough and kneading paddle if desired, reshape dough and replace in bread pan. Press Start to continue. When cycle is completed, remove bread from machine and transfer to wire rack to cool. Bread slices best when allowed to cool.

**To prepare using Rapid White bread cycle:** Select Rapid White, medium crust or crust to taste, loaf size. Use rapid rise yeast in place of standard yeast in recipe and add vital wheat gluten (optional – aids in rise).

<b>Ingredients</b>	<b>Large – 2 pounds</b>	<b>Medium – 1½ pounds</b>	<b>Small – 1 pound</b>
<b>Rapid rise yeast</b>	<b>3 teaspoons</b>	<b>2½ teaspoons</b>	<b>2 teaspoons</b>
<b>Vital wheat gluten (optional)</b>	<b>2 teaspoons</b>	<b>1½ teaspoons</b>	<b>1 teaspoon</b>

*Nutritional information per serving (1 ounce):*

*Calories 77 (17% from fat) • carb. 13g • pro. 2g • fat 1g • sat. fat 1g • chol. 3mg • sod. 116mg • calc. 16mg • fiber 0g*

# Oatmeal Bread

White Bread Cycle  
Delay Start Timer - No

<b>Ingredients</b>	<b>Large – 2 pounds</b>	<b>Medium – 1½ pounds</b>	<b>Small – 1 pound</b>
Buttermilk, 80°–90°F	1½ cups	1 cup	¾ cup
Unsalted butter, ½-inch pieces at room temperature	2 tablespoons	1½ tablespoons	1 tablespoon
Salt	1½ teaspoons	1 teaspoon	¾ teaspoon
Maple syrup (not pancake syrup)	2 tablespoons	1½ tablespoons	1 tablespoon
Bread flour	4 cups	3 cups	2 cups
Old-fashioned oats	1 cup	¾ cup	½ cup
Yeast, active dry, instant or bread machine	2¼ teaspoons	2¼ teaspoons	2 teaspoons

Place all ingredients, in the order listed, in the bread pan fitted with the kneading paddle. Place the bread pan in the Cuisinart™ Convection Bread Maker. Press Menu and select White. Press Crust and select Medium (or to taste). Press Loaf and select dough size. Press Start to mix, knead, rise, and bake. When pause signal sounds, remove dough and kneading paddle if desired, reshape dough and replace in bread pan. Press Start to continue. When cycle is completed, remove bread from machine and transfer to wire rack to cool. Bread slices best when allowed to cool.

**To prepare using Rapid White bread cycle:** Select Rapid White, medium crust or crust to taste, loaf size. Use rapid rise yeast in place of standard yeast in recipe and add vital wheat gluten (optional – aids in rise).

<b>Ingredients</b>	<b>Large – 2 pounds</b>	<b>Medium – 1½ pounds</b>	<b>Small – 1 pound</b>
Rapid rise yeast	3 teaspoons	2½ teaspoons	2 teaspoons
Vital wheat gluten (optional)	2 teaspoons	1½ teaspoons	1 teaspoon

*Nutritional information per serving (1 ounce):*

*Calories 86 (13% from fat) • carb. 16g • pro. 3g • fat 1g • sat. fat 1g • chol. 2mg • sod. 109mg • calc. 18mg • fiber 1g*

# Cinnamon Swirl Bread

White Bread Cycle  
Delay Start Timer - No

<b>Ingredients</b>	<b>Large – 2 pounds</b>	<b>Medium – 1½ pounds</b>	<b>Small – 1 pound</b>
Granulated sugar	¼ cup	¼ cup	¼ cup
Cinnamon	¾ tablespoon	½ tablespoon	½ tablespoon
Raisins (optional)	1¼ cups	1¼ cups	1¼ cups
Milk	1¼ cups	1 cup	¾ cup
Butter, at room temperature	2½ tablespoons	2 tablespoons	1½ tablespoons
Egg, large, at room temperature*	1	1	1
Salt	1 teaspoon	1 teaspoon	½ teaspoon
Granulated sugar	1½ tablespoons	1 tablespoon	1 tablespoon
Bread flour	4 cups	3½ cups	2½ cups
Yeast, active dry, instant or bread machine	2½ teaspoons	2¼ teaspoons	2 teaspoons

In a small bowl combine the first listed granulated sugar, cinnamon, and raisins if using. Reserve.

Place remaining ingredients, in the order listed, in the bread pan fitted with the kneading paddle. Place the bread pan in the Cuisinart™ Convection Bread Maker. Press Menu and select White. Press Crust and select Medium (or to taste). Press Loaf and select dough size. Press Start to mix, knead, rise and bake. When the pause signal sounds, press Pause, remove dough and kneading paddle. Place dough on a floured surface. Roll the dough out into a rectangle, about ¼" thick. Sprinkle the cinnamon-sugar mixture evenly over the surface of the dough. Roll the dough into a tight cylinder starting with the shorter side, making sure that the ends are sealed. Place dough back into the bread pan (make sure the kneading paddle is removed) and press Start to continue. When cycle is completed, remove bread from machine and transfer to wire rack to cool. Bread slices best when allowed to cool.

\* Gently and safely warm cold eggs by placing whole eggs in a bowl and covering with moderately hot tap water for 10 minutes.

**To prepare using Rapid White bread cycle:** Select Rapid White, medium crust or crust to taste, loaf size.

Use rapid rise yeast in place of standard yeast in recipe and add vital wheat gluten (optional – aids in rise).

<b>Ingredients</b>	<b>Large – 2 pounds</b>	<b>Medium – 1½ pounds</b>	<b>Small – 1 pound</b>
Rapid rise yeast	3 teaspoons	2½ teaspoons	2 teaspoons
Vital wheat gluten (optional)	2 teaspoons	1½ teaspoons	1 teaspoon

*Nutritional information per serving (1 ounce):*

Calories 98 (16% from fat) • carb. 17g • pro. 3g • fat 2g • sat. fat 1g • chol. 12mg • sod. 106mg • calc. 19mg • fiber 1g

Download from [www.somanuals.com](http://www.somanuals.com). All Manuals Search And Download.

# Granola Bread

White Bread Cycle  
Delay Start Timer - No

<b>Ingredients</b>	<b>Large – 2 pounds</b>	<b>Medium – 1½ pounds</b>	<b>Small – 1 pound</b>
Milk, lowfat, 80°–90°F	1¼ cups	1 cup	¾ cup
Unsalted butter, ½-inch pieces at room temperature	2½ tablespoons	2 tablespoons	1½ tablespoons
Honey	2½ tablespoons	2 tablespoons	1½ tablespoons
Salt	1¼ teaspoons	1 teaspoon	¾ teaspoon
Granola	1 cup	¾ cup	½ cup
Bread flour	3¾ cups	3 cups	2¾ cups
Cinnamon	¾ teaspoon	½ teaspoon	¼ teaspoon
Yeast, active dry, instant or bread machine	2½ teaspoons	2¼ teaspoons	2 teaspoons

Place ingredients, in the order listed, in the bread pan fitted with the kneading paddle. Place the bread pan in the Cuisinart™ Convection Bread Maker. Press Menu and select White. Press Crust and select Medium (or to taste). Press Loaf and select dough size. Press Start to mix, knead, rise and bake. When pause signal sounds, remove dough and kneading paddle if desired, reshape dough and replace in bread pan. Press Start to continue. When cycle is completed, remove bread from machine and transfer to wire rack to cool. Bread slices best when allowed to cool.

**To prepare using Rapid White bread cycle:** Select Rapid White, medium crust or crust to taste, loaf size. Use rapid rise yeast in place of standard yeast in recipe and add vital wheat gluten (optional – aids in rise).

<b>Ingredients</b>	<b>Large – 2 pounds</b>	<b>Medium – 1½ pounds</b>	<b>Small – 1 pound</b>
Rapid rise yeast	3 teaspoons	2½ teaspoons	2 teaspoons
Vital wheat gluten (optional)	2 teaspoons	1½ teaspoons	1 teaspoon

*Nutritional information per serving (1 ounce):*

*Calories 87 (16% from fat) • carb. 16g • pro. 3g • fat 2g • sat. fat 1g • chol. 3mg • sod. 107mg • calc. 17mg • fiber 1g*



# Rosemary Bread

White Bread Cycle  
Delay Start Timer - Yes

<b>Ingredients</b>	<b>Large – 2 pounds</b>	<b>Medium – 1½ pounds</b>	<b>Small – 1 pound</b>
Water, 80°–90°F	1½ cups	¾ cup	1 cup
Olive oil, extra virgin	4 tablespoons	3 tablespoons	2 tablespoons
Salt, sea or kosher	1½ teaspoons	1 teaspoon	¾ teaspoon
Bread flour	4 cups	3 cups	2 cups
Dried rosemary	3 teaspoons	2 teaspoons	1½ teaspoons
Yeast, active dry, instant or bread machine	2¼ teaspoons	2¼ teaspoons	2 teaspoons

Place ingredients, in the order listed, in the bread pan fitted with the kneading paddle. Place the bread pan in the Cuisinart™ Convection Bread Maker. Press Menu and select White. Press Crust and select Medium (or to taste). Press Loaf and select dough size. Press Start to mix, knead, rise and bake. When pause signal sounds, remove dough and kneading paddle if desired, reshape dough and replace in bread pan. Press Start to continue. When cycle is completed, remove bread from machine and transfer to wire rack to cool. Bread slices best when allowed to cool.

**To prepare using Rapid White bread cycle:** Select Rapid White, medium crust or crust to taste, loaf size.

Use rapid rise yeast in place of standard yeast in recipe and add vital wheat gluten (optional – aids in rise).

<b>Ingredients</b>	<b>Large – 2 pounds</b>	<b>Medium – 1½ pounds</b>	<b>Small – 1 pound</b>
Rapid rise yeast	3 teaspoons	2½ teaspoons	2 teaspoons
Vital wheat gluten (optional)	2 teaspoons	1½ teaspoons	1 teaspoon

*Nutritional information per serving (1 ounce):*

*Calories 78 (23% from fat) • carb. 13g • pro. 2g • fat 2g • sat. fat 0g • chol. 0mg • sod. 98mg • calc. 4mg • fiber 0g*

# Pesto Bread

White Bread Cycle  
Delay Start Timer - Yes

<b>Ingredients</b>	<b>Large – 2 pounds</b>	<b>Medium – 1½ pounds</b>	<b>Small – 1 pound</b>
Water, 80°–90°F	1½ cups	1 cup	¾ cup
Olive oil, extra virgin	3 tablespoons	2 tablespoons	1 tablespoon
Pesto	5 tablespoons	¼ cup	3 tablespoons
Sea salt	1 teaspoon	¾ teaspoon	½ teaspoon
Bread flour	4½ cups	3½ cups	2½ cups
Granulated sugar	1½ teaspoons	1 teaspoon	1 teaspoon
Yeast, active dry, instant or bread machine	2 teaspoons	1¼ teaspoons	1½ teaspoons

Place ingredients, in the order listed, in the bread pan fitted with the kneading paddle. Place the bread pan in the Cuisinart™ Convection Bread Maker. Press Menu and select White. Press Crust and select Medium (or to taste). Press Loaf and select dough size. Press Start to mix, knead, rise and bake. When pause signal sounds, remove dough and kneading paddle if desired, reshape dough and replace in bread pan. Press Start to continue. When cycle is completed, remove bread from machine and transfer to wire rack to cool. Bread slices best when allowed to cool.

**To prepare using Rapid White bread cycle:** Select Rapid White, medium crust or crust to taste, loaf size. Use rapid rise yeast in place of standard yeast in recipe and add vital wheat gluten (optional – aids in rise).

<b>Ingredients</b>	<b>Large – 2 pounds</b>	<b>Medium – 1½ pounds</b>	<b>Small – 1 pound</b>
Rapid rise yeast	3 teaspoons	2½ teaspoons	2 teaspoons
Vital wheat gluten (optional)	2 teaspoons	1½ teaspoons	1 teaspoon

*Nutritional information per serving (1 ounce):*

*Calories 96 (25% from fat) • carb. 15g • pro. 3g • fat 3g • sat. fat 0g • chol. 0mg • sod. 89mg • calc. 11mg • fiber 1g*

## Blue Cheese and Olive Bread

White Bread Cycle  
Delay Start Timer - No

<b>Ingredients</b>	<b>Large – 2 pounds</b>	<b>Medium – 1½ pounds</b>	<b>Small – 1 pound</b>
Water, 80°–90°F	¾ cup	½ cup	½ cup + 2 tablespoons
Dry white wine, at room temperature	3 tablespoons	2 tablespoons	1 tablespoon
Unsalted butter, ½-inch pieces at room temperature	1½ tablespoons	1 tablespoon	½ tablespoon
Egg, large, at room temperature*	1	1	1
Salt	1¼ teaspoons	1 teaspoon	½ teaspoon
Honey	1 tablespoon	1 tablespoon	1 tablespoon
Bread flour	3¾ cups	3 cups + 2 tablespoons	2½ cups
Nonfat dry milk	2 tablespoons	2 tablespoons	1½ tablespoons
Yeast, active dry, instant or bread machine	2 teaspoons	1¼ teaspoons	1½ teaspoons
Blue cheese	¾ cup	½ cup	½ cup
Green olives, well drained, patted dry	¾ cup	½ cup	½ cup

Place water, wine, butter, egg, salt, honey, bread flour, nonfat milk, and yeast, in order listed, in the bread pan fitted with the kneading paddle. Place the bread pan in the Cuisinart™ Convection Bread Maker. Press Menu and select White cycle. Press Crust and select Medium (or to taste). Press Start to mix, knead, rise and bake. When Mix-in's tone sounds, add blue cheese and olives. If desired, when pause tone sounds, remove dough and paddle, reshape dough and replace in bread pan. Press Start to continue. When cycle is completed, remove bread from machine and transfer to wire rack to cool. Bread slices best when allowed to cool.

\* Gently and safely warm cold eggs by placing whole eggs in a bowl and covering with moderately hot tap water for 10 minutes.

**To prepare using Rapid White bread cycle:** Select Rapid White, medium crust or crust to taste, loaf size.

Use rapid rise yeast in place of standard yeast in recipe and add vital wheat gluten (optional – aids in rise).

<b>Ingredients</b>	<b>Large – 2 pounds</b>	<b>Medium – 1½ pounds</b>	<b>Small – 1 pound</b>
Rapid rise yeast	3 teaspoons	2½ teaspoons	2 teaspoons
Vital wheat gluten (optional)	2 teaspoons	1½ teaspoons	1 teaspoon

*Nutritional information per serving (1 ounce):*

*Calories 93 (24% from fat) • carb. 14g • pro. 3g • fat 2g • sat. fat 1g • chol. 12mg • sod. 254mg • calc. 22mg • fiber 1g*

# Sun-dried Tomato and Mozzarella Bread

White Bread Cycle  
Delay Start Timer - No

<b>Ingredients</b>	<b>Large – 2 pounds</b>	<b>Medium – 1½ pounds</b>	<b>Small – 1 pound</b>
Water, 80°–90°F	1 cup	¾ cup + 1 tablespoon	½ cup + 3 tablespoons
Salt	1 teaspoon	¾ teaspoon	¾ teaspoon
Granulated sugar	1 teaspoon	¾ teaspoon	½ teaspoon
Bread flour	3¾ cups	2¾ cups	2 cups
Italian seasoning	1¼ teaspoons	1 teaspoon	¾ teaspoon
Yeast, active dry, instant or bread machine	2¼ teaspoons	2¼ teaspoons	2 teaspoons
Shredded mozzarella cheese	1¼ cups	6 ounces	4 ounces
Oil-packed sun-dried tomatoes, drained and roughly chopped	¼ cup + 2 tablespoons	¼ cup	3 tablespoons

Place water, salt, sugar, bread flour, Italian seasoning and yeast, in order listed, in the bread pan fitted with the kneading paddle. Place the bread pan in the Cuisinart™ Convection Bread Maker. Press Menu and select White. Press Crust and select Medium (or to taste). Press Loaf and select dough size. Press Start to mix, knead, rise and bake. When Mix-in's tone sounds, add cheese and tomatoes. When pause signal sounds, remove dough and kneading paddle if desired, reshape dough and replace in bread pan. Press Start to continue. When cycle is completed, remove bread from machine and transfer to wire rack to cool. Bread slices best when allowed to cool.

**To prepare using Rapid White bread cycle:** Select Rapid White, medium crust or crust to taste, loaf size. Use rapid rise yeast in place of standard yeast in recipe and add vital wheat gluten (optional – aids in rise).

<b>Ingredients</b>	<b>Large – 2 pounds</b>	<b>Medium – 1½ pounds</b>	<b>Small – 1 pound</b>
Rapid rise yeast	3 teaspoons	2½ teaspoons	2 teaspoons
Vital wheat gluten (optional)	2 teaspoons	1½ teaspoons	1 teaspoon

*Nutritional information per serving (1 ounce):*

*Calories 81 (22% from fat) • carb. 12g • pro. 3g • fat 2g • sat. fat 1g • chol. 6mg • sod. 103mg • calc. 41mg • fiber 12g*

# Beer Bread

White Bread Cycle  
Delay Start Timer - Yes

<b>Ingredients</b>	<b>Large – 2 pounds</b>	<b>Medium – 1½ pounds</b>	<b>Small – 1 pound</b>
Water, 80°–90°F	½ cup + 2 tablespoons	½ cup	6 tablespoons
*Beer, at room temperature – may use “light”	½ cup + 2 tablespoons	½ cup	6 tablespoons
Salt	1¼ teaspoons	1 teaspoon	¾ teaspoon
Granulated sugar	1 tablespoon + 1 teaspoon	1 tablespoon	2½ teaspoons
Bread flour	3¾ cups	3 cups	2¼ cups
Yeast, active dry, instant or bread machine	2¼ teaspoons	2¼ teaspoons	2 teaspoons

Place ingredients, in the order listed, in the bread pan fitted with the kneading paddle. Place the bread pan in the Cuisinart™ Convection Bread Maker. Press Menu and select White. Press Crust and select Medium (or to taste). Press Loaf and select dough size. Press Start to mix, knead, rise and bake. When pause signal sounds, remove dough and kneading paddle if desired, reshape dough and replace in bread pan. Press Start to continue. When cycle is completed, remove bread from machine and transfer to wire rack to cool. Bread slices best when allowed to cool.

\*Do not use a beer that you would not drink – it adds flavor to the bread.

**To prepare using Rapid White bread cycle:** Select Rapid White, medium crust or crust to taste, loaf size. Use rapid rise yeast in place of standard yeast in recipe and add vital wheat gluten (optional – aids in rise).

<b>Ingredients</b>	<b>Large – 2 pounds</b>	<b>Medium – 1½ pounds</b>	<b>Small – 1 pound</b>
Rapid rise yeast	3 teaspoons	2½ teaspoons	2 teaspoons
Vital wheat gluten (optional)	2 teaspoons	1½ teaspoons	1 teaspoon

*Nutritional information per serving (1 ounce):*

*Calories 67 (4% from fat) • carb. 13g • pro. 2g • fat 0g • sat. fat 0g • chol. 0mg • sod. 98mg • calc. 3mg • fiber 1g*

# Potato Bread

White Bread Cycle

Delay Start Timer - No

<b>Ingredients</b>	<b>Large – 2 pounds</b>	<b>Medium – 1½ pounds</b>	<b>Small – 1 pound</b>
Potato cooking water, cooled to 80°–90°F	¾ cup	½ cup + 1 tablespoon	6 tablespoons
Unsalted butter, ½-inch pieces at room temperature	2 tablespoons	1 tablespoon	1 tablespoon
Egg, large, at room temperature*	1	1	1
Mashed potato (plain without milk, butter or seasonings)	1 cup	¾ cup	½ cup
Salt	1½ teaspoons	1 teaspoon	¾ teaspoon
Granulated sugar	1 teaspoon	1 teaspoon	½ teaspoon
Bread flour	4 cups	3 cups	2½ cups
Nonfat dry milk	2 tablespoons	1½ tablespoons	1 tablespoon + 1 teaspoon
Potato starch	2 tablespoons	1½ tablespoons	1 tablespoon + 1 teaspoon
Yeast, active dry, instant or bread machine	2½ teaspoons	2¼ teaspoons	2 teaspoons

Place ingredients, in the order listed, in the bread pan fitted with the kneading paddle. Place the bread pan in the Cuisinart™ Convection Bread Maker. Press Menu and select White. Press Crust and select Medium (or to taste). Press Loaf and select dough size. Press Start to mix, knead, rise and bake. When pause signal sounds, remove dough and kneading paddle if desired, reshape dough and replace in bread pan. Press Start to continue. When cycle is completed, remove bread from machine and transfer to wire rack to cool. Bread slices best when allowed to cool.

\* Gently and safely warm cold eggs by placing whole eggs in a bowl and covering with moderately hot tap water for 10 minutes.

**To prepare using Rapid White bread cycle:** Select Rapid White, medium crust or crust to taste, loaf size.

Use rapid rise yeast in place of standard yeast in recipe and add vital wheat gluten (optional – aids in rise).

<b>Ingredients</b>	<b>Large – 2 pounds</b>	<b>Medium – 1½ pounds</b>	<b>Small – 1 pound</b>
Rapid rise yeast	3 teaspoons	2½ teaspoons	2 teaspoons
Vital wheat gluten (optional)	2 teaspoons	1½ teaspoons	1 teaspoon

*Nutritional information per serving (1 ounce):*

*Calories 68 (14% from fat) • carb. 12g • pro. 2g • fat 1g • sat. fat 0g • chol. 10mg • sod. 105mg • calc. 11mg • fiber 0g*

# Three-Cheese Bread

White Bread Cycle  
Delay Start Timer - No

<b>Ingredients</b>	<b>Large – 2 pounds</b>	<b>Medium – 1½ pounds</b>	<b>Small – 1 pound</b>
Water, 80°–90°F	¾ cup + 2 tablespoons	¾ cup + 1 tablespoon	7 tablespoons
Part-skim ricotta cheese	½ cup	6 tablespoons	¼ cup
Shredded extra-sharp Cheddar cheese	1 cup (4 oz.)	¾ cup (3 oz.)	½ cup (2 oz.)
Grated Asiago cheese	½ cup (2 oz.)	½ cup (1½ oz.)	½ cup (1 oz.)
Granulated sugar	2 tablespoons	4½ teaspoons	1 tablespoon
Salt	1½ teaspoons	1½ teaspoons	¾ teaspoon
Tabasco® or other hot sauce	1 teaspoon	¾ teaspoon	½ teaspoon
Bread flour	4½ cups	3 cups + 3 tablespoons	2 cups + 2 tablespoons
Yeast, active dry, instant or bread machine	2 teaspoons	1½ teaspoons	1 teaspoon

Place ingredients, in the order listed, in the bread pan fitted with the kneading paddle. Place the bread pan in the Cuisinart™ Convection Bread Maker. Press Menu and select White. Press Crust and select Medium (or to taste). Press Loaf and select dough size. Press Start to mix, knead, rise and bake. When pause signal sounds, remove dough and kneading paddle if desired, reshape dough and replace in bread pan. Press Start to continue. When cycle is completed, remove bread from machine and transfer to wire rack to cool. Bread slices best when allowed to cool.

**Variation:** Three Cheese & Bacon Bread – When selecting Menu choices, choose Mix-ins. Add ¾–½–¼ cup cooked diced bacon when Mix-in signal sounds.

**To prepare using Rapid White bread cycle:** Select Rapid White, medium crust, loaf size.

Use rapid rise yeast in place of standard yeast in recipe and add vital wheat gluten (optional – aids in rise).

<b>Ingredients</b>	<b>Large – 2 pounds</b>	<b>Medium – 1½ pounds</b>	<b>Small – 1 pound</b>
Rapid rise yeast	3 teaspoons	2½ teaspoons	2 teaspoons
Vital wheat gluten (optional)	2 teaspoons	1½ teaspoons	1 teaspoon

*Nutritional information per serving (1 ounce) (made without bacon):*

*Calories 84 (26% from fat) • carb. 12g • pro. 4g • fat 2g • sat. fat 1g • chol. 7mg • sod. 51mg • calc. 59mg • fiber 0g*

# Basic Honey Whole Wheat Bread

Whole Wheat Bread Cycle  
Delay Start Timer - Yes

<b>Ingredients</b>	<b>Large – 2 pounds</b>	<b>Medium – 1½ pounds</b>	<b>Small – 1 pound</b>
<b>Water, 80°–90°F</b>	<b>1¼ cups</b>	<b>1 cup + 1 tablespoon</b>	<b>1 cup</b>
<b>Salt</b>	<b>1¼ teaspoons</b>	<b>1 teaspoon</b>	<b>¾ teaspoon</b>
<b>Unsalted butter, ½-inch pieces at room temperature</b>	<b>2½ tablespoons</b>	<b>2 tablespoons</b>	<b>1½ tablespoons</b>
<b>Honey</b>	<b>2 tablespoons</b>	<b>1½ tablespoons</b>	<b>1 tablespoon</b>
<b>Bread flour</b>	<b>1¼ cups</b>	<b>1 cup</b>	<b>¾ cup</b>
<b>Whole wheat flour</b>	<b>2½ cups</b>	<b>2 cups</b>	<b>1½ cups</b>
<b>Yeast, active dry, instant or bread machine</b>	<b>2¼ teaspoons</b>	<b>2¼ teaspoons</b>	<b>2 teaspoons</b>

Place all ingredients, in the order listed, in the bread pan fitted with the kneading paddle. Place the bread pan in the Cuisinart™ Convection Bread Maker. Press Menu and select Whole Wheat. Press Crust and select Medium (or to taste). Press Loaf and select dough size. Press Start to mix, knead, rise, and bake. If desired, when pause tone sounds, remove dough and paddle. Shape dough into a ball and replace in bread pan. Press Start to continue. When cycle is completed, remove bread from machine and transfer to wire rack to cool. Bread slices best when allowed to cool.

**To prepare using Rapid Whole Wheat cycle:** Select Rapid Whole Wheat, medium crust or crust to taste, loaf size.

Use rapid rise yeast in place of standard yeast in recipe and add vital wheat gluten (optional – aids in rise).

<b>Ingredients</b>	<b>Large – 2 pounds</b>	<b>Medium – 1½ pounds</b>	<b>Small – 1 pound</b>
<b>Rapid rise yeast</b>	<b>3 teaspoons</b>	<b>2½ teaspoons</b>	<b>2 teaspoons</b>
<b>Vital wheat gluten (optional)</b>	<b>2 teaspoons</b>	<b>1½ teaspoons</b>	<b>1 teaspoon</b>

*Nutritional information per serving (1 ounce):*

*Calories 73 (15% from fat) • carb. 14g • pro. 2g • fat 1g • sat. fat 1g • chol. 3mg • sod. 99mg • calc. 5mg • fiber 1g*



# Buttermilk Whole Wheat Bread

Whole Wheat Bread Cycle  
Delay Start Timer - No

<b>Ingredients</b>	<b>Large – 2 pounds</b>	<b>Medium – 1½ pounds</b>	<b>Small – 1 pound</b>
Buttermilk, 80°–90°F	1½ cups	1¼ cups	1 cup + 1 tablespoon
Salt	1¼ teaspoons	1 teaspoon	¾ teaspoon
Maple syrup (not pancake syrup)	2 tablespoons	1½ tablespoons	1 tablespoon
Whole wheat flour	4 cups	3¾ cups	2 cups + 6 tablespoons
Vital wheat gluten	1¼ teaspoons	1 teaspoon	¾ teaspoon
Currants	¾ cup	½ cup	⅓ cup
Yeast, active dry, instant or bread machine	2¼ teaspoons	2¼ teaspoons	2 teaspoons

Place ingredients, in the order listed, in the bread pan fitted with the kneading paddle. Place the bread pan in the Cuisinart™ Convection Bread Maker. Press Menu and select Whole Wheat. Press Crust and select Medium (or to taste). Press Loaf and select dough size. Press Start to mix, knead, rise and bake. When pause signal sounds, remove dough and kneading paddle if desired, reshape dough and replace in bread pan. Press Start to continue. When cycle is completed, remove bread from machine and transfer to wire rack to cool. Bread slices best when allowed to cool.

**To prepare using Rapid Whole Wheat cycle:** Select Rapid Whole Wheat, medium crust or crust to taste, loaf size.

Use rapid rise yeast in place of standard yeast in recipe and add vital wheat gluten (optional – aids in rise).

<b>Ingredients</b>	<b>Large – 2 pounds</b>	<b>Medium – 1½ pounds</b>	<b>Small – 1 pound</b>
Rapid rise yeast	3 teaspoons	2½ teaspoons	2 teaspoons
Vital wheat gluten (optional)	2 teaspoons	1½ teaspoons	1 teaspoon

*Nutritional information per serving (1 ounce):*

*Calories 74 (5% from fat) • carb. 15g • pro. 3g • fat 0g • sat. fat 0g • chol. 1mg • sod. 115mg • calc. 26mg • fiber 2g*

# Multi-Grain Cereal Wheat Bread

Whole Wheat Bread Cycle  
Delay Start Timer – No

<b>Ingredients</b>	<b>Large – 2 pounds</b>	<b>Medium – 1½ pounds</b>	<b>Small – 1 pound</b>
Water, 80°–90°F	1¼ cups	¾ cup + 3 tablespoons	½ cup + 2 tablespoons
Plain fat-free yogurt	½ cup	¼ cup	2 tablespoons + 2 teaspoons
Unsalted butter, ½-inch pieces at room temperature	3 tablespoons	2 tablespoons + 1 teaspoon	1½ tablespoons
Brown sugar, packed	2 tablespoons	4½ teaspoons	1 tablespoon
Salt	1½ teaspoons	1½ teaspoons	¾ teaspoon
Bread flour	2 cups	1½ cups	1 cup
Whole wheat flour	2 cups	1½ cups	1 cup
7-grain cereal flakes	2% cups	2 cups	1½ cups
Yeast, active dry, instant or bread machine	2½ teaspoons	2 teaspoons	1¼ teaspoons

Place all ingredients, in the order listed, in the bread pan fitted with the kneading paddle. Place the bread pan in the Cuisinart™ Convection Bread Maker. Press Menu and select Whole Wheat. Press Crust and select Medium (or to taste). Press Loaf and select dough size. Press Start to mix, knead, rise, and bake. If desired, when pause tone sounds, remove dough and paddle. Shape dough into a ball and replace in bread pan. Press Start to continue. When cycle is completed, remove bread from machine and transfer to wire rack to cool. Bread slices best when allowed to cool.

**Variation:** Select Mix-Ins and add raisins, dried cherries or cranberries: ¾ cup – ½ cup – 6 tablespoons, depending upon loaf size.

**To prepare using Rapid Whole Wheat cycle:** Select Rapid Whole Wheat, medium crust or crust to taste, loaf size.

Use rapid rise yeast in place of standard yeast in recipe and add vital wheat gluten (optional – aids in rise).

<b>Ingredients</b>	<b>Large – 2 pounds</b>	<b>Medium – 1½ pounds</b>	<b>Small – 1 pound</b>
Rapid rise yeast	3 teaspoons	2½ teaspoons	2 teaspoons
Vital wheat gluten (optional)	2 teaspoons	1½ teaspoons	1 teaspoon

*Nutritional information per serving (1 ounce):*

*Calories 64 (20% from fat) • carb. 11g • pro. 2g • fat 1g • sat. fat 1g • chol. 3mg • sod. 115mg • calc. 7mg • fiber 1g*

# Nutty Whole Wheat Bread

Whole Wheat Bread Cycle  
Delay Start Timer - No

<b>Ingredients</b>	<b>Large – 2 pounds</b>	<b>Medium – 1½ pounds</b>	<b>Small – 1 pound</b>
Buttermilk, 80°–90°F	1¼ cups	1 cup	¾ cup
Salt	1 teaspoon	¾ teaspoon	½ teaspoon
Unsalted butter, ½-inch pieces at room temperature	1½ tablespoons	1 tablespoon	1 tablespoon
Maple syrup (not pancake syrup)	1½ tablespoons	1 tablespoon	1 tablespoon
Bread flour	1¼ cups	1 cup	¾ cup
Whole wheat flour	2½ cups	2 cups	1½ cups
Yeast, active dry, instant or bread machine	2¼ teaspoons	2¼ teaspoons	2 teaspoons
Mixed nuts and seeds (i.e. walnuts, pecans, pumpkin seeds, sunflower seeds)	1 cup	¾ cup	½ cup

Place buttermilk, salt, butter, maple syrup, bread flour, whole wheat flour, and yeast, in order listed, in the bread pan fitted with the kneading paddle. Place the bread pan in the Cuisinart™ Convection Bread Maker. Press Menu and select Whole Wheat. Press Crust and select Medium (or to taste). Press Loaf and select dough size. Press Start to mix, knead, rise and bake. When Mix-in's tone sounds, add mixed nuts and seeds. When pause signal sounds, remove dough and kneading paddle if desired, reshape dough and replace in bread pan. Press Start to continue. When cycle is completed, remove bread from machine and transfer to wire rack to cool. Bread slices best when allowed to cool.

**To prepare using Rapid Whole Wheat cycle:** Select Rapid Whole Wheat, medium crust or crust to taste, loaf size.  
Use rapid rise yeast in place of standard yeast in recipe and add vital wheat gluten (optional – aids in rise).

<b>Ingredients</b>	<b>Large – 2 pounds</b>	<b>Medium – 1½ pounds</b>	<b>Small – 1 pound</b>
Rapid rise yeast	3 teaspoons	2½ teaspoons	2 teaspoons
Vital wheat gluten (optional)	2 teaspoons	1½ teaspoons	1 teaspoon

*Nutritional information per serving (1 ounce):*

*Calories 90 (30% from fat) • carb. 13g • pro. 3g • fat 3g • sat. fat 1g • chol. 2mg • sod. 85mg • calc. 21mg • fiber 2g*

# True 100% Whole Wheat Bread

Whole Wheat Bread Cycle

Delay Start Timer - Yes

<b>Ingredients</b>	<b>Large – 2 pounds</b>	<b>Medium – 1½ pounds</b>	<b>Small – 1 pound</b>
<b>Water, 80°–90°F</b>	<b>1¼ cups</b>	<b>1 cup + 1 tablespoon</b>	<b>1 cup</b>
<b>Salt</b>	<b>1¼ teaspoons</b>	<b>1 teaspoon</b>	<b>¾ teaspoon</b>
<b>Honey</b>	<b>2 tablespoons</b>	<b>1½ tablespoons</b>	<b>1 tablespoon</b>
<b>Whole wheat flour</b>	<b>4 cups</b>	<b>3¾ cups</b>	<b>2 cups + 6 tablespoons</b>
<b>Vital wheat gluten</b>	<b>5½ teaspoons</b>	<b>4½ teaspoons</b>	<b>3 teaspoons</b>
<b>Yeast, active dry, instant or bread machine</b>	<b>2¼ teaspoons</b>	<b>2¼ teaspoons</b>	<b>2 teaspoons</b>

Place ingredients, in the order listed, in the bread pan fitted with the kneading paddle. Place the bread pan in the Cuisinart™ Convection Bread Maker. Press Menu and select Whole Wheat. Press Crust and select Medium (or to taste). Press Loaf and select dough size. Press Start to mix, knead, rise and bake. When pause signal sounds, remove dough and kneading paddle if desired, reshape dough and replace in bread pan. Press Start to continue. When cycle is completed, remove bread from machine and transfer to wire rack to cool. Bread slices best when allowed to cool.

**To prepare using Rapid Whole Wheat cycle:** Select Rapid Whole Wheat, medium crust or crust to taste, loaf size.

Use rapid rise yeast in place of standard yeast in recipe and add vital wheat gluten (optional – aids in rise).

<b>Ingredients</b>	<b>Large – 2 pounds</b>	<b>Medium – 1½ pounds</b>	<b>Small – 1 pound</b>
<b>Rapid rise yeast</b>	<b>3 teaspoons</b>	<b>2½ teaspoons</b>	<b>2 teaspoons</b>
<b>Vital wheat gluten (optional)</b>	<b>2 teaspoons</b>	<b>1½ teaspoons</b>	<b>1 teaspoon</b>

*Nutritional information per serving (1 ounce):*

*Calories 61 (4% from fat) • carb. 13g • pro. 2g • fat 0g • sat. fat 0g • chol. 0mg • sod. 99mg • calc. 6mg • fiber 2g*

# Whole Grain Whole Wheat Bread

Whole Wheat Cycle  
Delay Start Timer - No

<b>Ingredients</b>	<b>Large – 2 pounds</b>	<b>Medium – 1½ pounds</b>	<b>Small – 1 pound</b>
Water, 80°–90°F	1½ cups	1¼ cups	1 cup + 1 tablespoon
Unsalted butter, ½-inch pieces at room temperature	1¼ tablespoons	1 tablespoon	¾ tablespoon
Salt	1¼ teaspoons	1 teaspoon	¾ teaspoon
Honey	2½ tablespoons	2 tablespoons	1½ tablespoons
Whole wheat flour	3 cups + 6 tablespoons	2¾ cups	2 cups
Barley flour	¾ cup	½ cup	¼ cup
Oats	2½ tablespoons	2 tablespoons	1½ tablespoons
Flax seed	¼ cup	¼ cup	2 tablespoons
Yeast, active dry, instant or bread machine	2¼ teaspoons	2¼ teaspoons	2 teaspoons

Place ingredients, in the order listed, in the bread pan fitted with the kneading paddle. Place the bread pan in the Cuisinart™ Convection Bread Maker. Press Menu and select Whole Wheat. Press Crust and select Medium (or to taste). Press Loaf and select dough size. Press Start to mix, knead, rise and bake. When pause signal sounds, remove dough and kneading paddle if desired, reshape dough and replace in bread pan. Press Start to continue. When cycle is completed, remove bread from machine and transfer to wire rack to cool. Bread slices best when allowed to cool.

**To prepare using Rapid Whole Wheat cycle:** Select Rapid Whole Wheat, medium crust or crust to taste, loaf size.

Use rapid rise yeast in place of standard yeast in recipe and add vital wheat gluten (optional – aids in rise).

<b>Ingredients</b>	<b>Large – 2 pounds</b>	<b>Medium – 1½ pounds</b>	<b>Small – 1 pound</b>
Rapid rise yeast	3 teaspoons	2½ teaspoons	2 teaspoons
Vital wheat gluten (optional)	2 teaspoons	1½ teaspoons	1 teaspoon

*Nutritional information per serving (1 ounce):*

*Calories 69 (13% from fat) • carb. 14g • pro. 2g • fat 1g • sat. fat 0g • chol. 1mg • sod. 101mg • calc. 7mg • fiber 2g*

# Wheat Bran Bread

Whole Wheat Cycle  
Delay Start Timer - Yes

<b>Ingredients</b>	<b>Large – 2 pounds</b>	<b>Medium – 1½ pounds</b>	<b>Small – 1 pound</b>
Water, 80°–90°F	1¼ cups	1 cup	1 cup + 1 tablespoon
Salt	1¼ teaspoons	1 teaspoon	¾ teaspoon
Unsalted butter, ½-inch pieces at room temperature	1½ tablespoons	1 tablespoon	¾ tablespoon
Molasses	2 tablespoons	1½ tablespoons	1 tablespoon
Whole wheat flour	3¾ cups	3 cups	2¼ cups
Old fashioned oats	½ cup + 2 tablespoons	½ cup	¼ cup
Wheat bran	½ cup + 2 tablespoons	½ cup	¼ cup
Yeast, active dry, instant or bread machine	2¼ teaspoons	2¼ teaspoons	2 teaspoons

Place ingredients, in the order listed, in the bread pan fitted with the kneading paddle. Place the bread pan in the Cuisinart™ Convection Bread Maker. Press Menu and select Whole Wheat. Press Crust and select Medium (or to taste). Press Loaf and select dough size. Press Start to mix, knead, rise and bake. When pause signal sounds, remove dough and kneading paddle if desired, reshape dough and replace in bread pan. Press Start to continue. When cycle is completed, remove bread from machine and transfer to wire rack to cool. Bread slices best when allowed to cool.

**To prepare using Rapid Whole Wheat cycle:** Select Rapid Whole Wheat, medium crust or crust to taste, loaf size.

Use rapid rise yeast in place of standard yeast in recipe and add vital wheat gluten (optional – aids in rise).

<b>Ingredients</b>	<b>Large – 2 pounds</b>	<b>Medium – 1½ pounds</b>	<b>Small – 1 pound</b>
Rapid rise yeast	3 teaspoons	2½ teaspoons	2 teaspoons
Vital wheat gluten (optional)	2 teaspoons	1½ teaspoons	1 teaspoon

*Nutritional information per serving (1 ounce):*

*Calories 65 (11% from fat) • carb. 13g • pro. 3g • fat 1g • sat. fat 0g • chol. 1mg • sod. 100mg • calc. 16mg • fiber 2g*

# Pumpnickel Raisin Bread

Whole Wheat Cycle

Delay Start Timer – Yes, but must be present to add raisins/caraway seeds

<b><i>Ingredients</i></b>	<b><i>Large – 2 pounds</i></b>	<b><i>Medium – 1½ pounds</i></b>	<b><i>Small – 1 pound</i></b>
<b>Water, 80°–90°F</b>	<b>1¼ cups</b>	<b>¾ cup + 3 tablespoons</b>	<b>½ cup + 2 tablespoons</b>
<b>Molasses</b>	<b>¼ cup</b>	<b>3 tablespoons</b>	<b>2 tablespoons</b>
<b>Vegetable oil</b>	<b>2 tablespoons</b>	<b>1½ tablespoons</b>	<b>1 tablespoon</b>
<b>Salt</b>	<b>1½ teaspoons</b>	<b>1½ teaspoons</b>	<b>¾ teaspoon</b>
<b>Bread flour</b>	<b>2½ cups</b>	<b>1¾ + 2 tablespoons</b>	<b>1¼ cups</b>
<b>Whole wheat flour</b>	<b>½ cup</b>	<b>6 tablespoons</b>	<b>¼ cup</b>
<b>Rye flour</b>	<b>½ cup</b>	<b>6 tablespoons</b>	<b>¼ cup</b>
<b>Cornmeal</b>	<b>½ cup</b>	<b>½ cup</b>	<b>2 tablespoons + 2 teaspoons</b>
<b>Unsweetened cocoa powder</b>	<b>2 tablespoons</b>	<b>1½ tablespoons</b>	<b>1 tablespoon</b>
<b>Instant espresso powder</b>	<b>1 teaspoon</b>	<b>¾ teaspoon</b>	<b>½ teaspoon</b>
<b>Yeast, active dry, instant or bread machine</b>	<b>2¼ teaspoons</b>	<b>1¾ teaspoons</b>	<b>1½ teaspoons</b>
<b>Vital wheat gluten</b>	<b>2 tablespoons</b>	<b>1½ tablespoons</b>	<b>1 tablespoon</b>
<b>Raisins</b>	<b>¾ cup</b>	<b>½ cup + 1 tablespoon</b>	<b>6 tablespoons</b>
<b>Caraway seeds</b>	<b>2 teaspoons</b>	<b>1½ teaspoons</b>	<b>1 teaspoon</b>

Place the water, molasses, oil, salt, bread flour, whole wheat flour, rye flour, cornmeal, cocoa powder, espresso powder, yeast, and vital wheat gluten, in the order listed, in the bread pan fitted with the kneading paddle. Place the bread pan in the Cuisinart™ Convection Bread Maker. Press Menu and select Whole Wheat. Press Crust and select Light (or to taste). Press Loaf and select dough size. Press Start to mix, knead, rise, and bake.

When Mix-in's tone sounds, add raisins and caraway seeds. When pause tone sounds, dough and kneading paddle may be removed. Reshape dough and replace in baking pan. Press Start to continue. When cycle is completed, remove bread from machine and transfer to wire rack to cool. Bread slices best when allowed to cool.

**To prepare using Rapid Whole Wheat cycle:** Select Rapid Whole Wheat, medium crust, loaf size.

Use rapid rise yeast in place of standard yeast in recipe and add vital wheat gluten (optional – aids in rise).

<b>Ingredients</b>	<b>Large – 2 pounds</b>	<b>Medium – 1½ pounds</b>	<b>Small – 1 pound</b>
Rapid rise yeast	3 teaspoons	2½ teaspoons	2 teaspoons
Vital wheat gluten (optional)	2 teaspoons	1½ teaspoons	1 teaspoon

*Nutritional information per serving (1 ounce):*

*Calories 81 (14% from fat) • carb. 16g • pro. 2g • fat 1g • sat. fat 0g • chol. 0mg • sod. 113mg • calc. 11mg • fiber 1g*



# Gruyère and Walnut Wheat Bread

Whole Wheat Cycle

Delay Start Timer – Yes, but must be present to add nuts and cheese

<b>Ingredients</b>	<b>Large – 2 pounds</b>	<b>Medium – 1½ pounds</b>	<b>Small – 1 pound</b>
Water, 80°–90°F	1½ cups	1⅔ cups	¾ cup
Walnut oil	2 tablespoons	1½ tablespoons	1 tablespoon
Granulated sugar	2 teaspoons	1½ teaspoons	1 teaspoon
Salt	2 teaspoons	1½ teaspoons	1 teaspoon
Bread flour	2 cups	1½ cups	1 cup
Whole wheat flour	2 cups	1½ cups	1 cup
Wheat germ	⅔ cup	½ cup	⅓ cup
Thyme (optional)	1 tablespoon	2 teaspoons	1½ teaspoons
Yeast, active dry, instant or bread machine	2¼ teaspoons	1¾ teaspoons	1½ teaspoons
Gruyère cheese, grated (not processed cheese)	4 ounces	3 ounces	2 ounces
Walnuts	¾ cup	½ cup	⅓ cup

Place water, walnut oil, sugar, salt, bread flour, whole wheat flour, wheat germ, optional thyme, and yeast, in order listed, in the bread pan fitted with the kneading paddle. Place the bread pan in the Cuisinart™ Convection Bread Maker. Press Menu and select Whole Wheat. Press Crust and select Medium (or to taste). Press Loaf and select dough size. Press Start to mix, knead, rise, and bake. When Mix-in's tone sounds, add grated Gruyère and walnuts. When pause tone sounds, dough and kneading paddle may be removed. Reshape dough and replace in baking pan. When cycle is completed, remove bread from machine and transfer to wire rack to cool. Bread slices best when allowed to cool.

**To prepare using Rapid Whole Wheat cycle:** Select Rapid Whole Wheat, medium crust or crust to taste, loaf size.

Use rapid rise yeast in place of standard yeast in recipe and add vital wheat gluten (optional – aids in rise).

<b>Ingredients</b>	<b>Large – 2 pounds</b>	<b>Medium – 1½ pounds</b>	<b>Small – 1 pound</b>
Rapid rise yeast	3 teaspoons	2½ teaspoons	2 teaspoons
Vital wheat gluten (optional)	2 teaspoons	1½ teaspoons	1 teaspoon

*Nutritional information per serving (1 ounce):*

*Calories 130 (57% from fat) • carb. 11g • pro. 4g • fat 8g • sat. fat 2g • chol. 4mg • sod. 160mg • calc. 41mg • fiber 1g*

# French Bread Loaf

French/Italian Bread Cycle  
Delay Start Timer - Yes

<b>Ingredients</b>	<b>Large – 2 pounds</b>	<b>Medium – 1½ pounds</b>	<b>Small – 1 pound</b>
<b>Water, 80°–90°F</b>	<b>1½ cups</b>	<b>1¼ cups + 1 tablespoon</b>	<b>1 cup + 1 tablespoon</b>
<b>Salt</b>	<b>1½ teaspoons</b>	<b>1¼ teaspoons</b>	<b>¾ teaspoon</b>
<b>Bread flour</b>	<b>4 cups</b>	<b>3½ cups</b>	<b>2 cups + 6 tablespoons</b>
<b>Yeast, active dry, instant or bread machine</b>	<b>2¼ teaspoons</b>	<b>2¼ teaspoons</b>	<b>2 teaspoons</b>

Place ingredients, in the order listed, in the bread pan fitted with the kneading paddle. Place the bread pan in the Cuisinart™ Convection Bread Maker. Press Menu and select French/Italian. Press Crust and select Light or Medium crust (to taste). Press Loaf and select dough Size. Press Start to mix, knead, rise and bake. When pause signal sounds, remove dough and kneading paddle if desired, reshape dough and replace in bread pan. Press start to continue. When cycle is completed, remove bread from machine and transfer to wire rack to cool. Bread slices best when allowed to cool.

**To prepare using Rapid French/Italian cycle:** Select Rapid French/Italian, medium crust or crust to taste, loaf size.

Use rapid rise yeast in place of standard yeast in recipe and add vital wheat gluten (optional – aids in rise).

<b>Ingredients</b>	<b>Large – 2 pounds</b>	<b>Medium – 1½ pounds</b>	<b>Small – 1 pound</b>
<b>Rapid rise yeast</b>	<b>3 teaspoons</b>	<b>2½ teaspoons</b>	<b>2 teaspoons</b>
<b>Vital wheat gluten (optional)</b>	<b>2 teaspoons</b>	<b>1½ teaspoons</b>	<b>1 teaspoon</b>

*Nutritional information per serving (1 ounce):*

*Calories 69 (4% from fat) • carb. 14g • pro. 2g • fat 0g • sat. fat 0g • chol. 0mg • sod. 123mg • calc. 3mg • fiber 0g*

# Rustic Italian Loaf

French/Italian Bread Cycle

Delay Start Timer – Yes, but must be present to add sesame seeds

<b>Ingredients</b>	<b>Large – 2 pounds</b>	<b>Medium – 1½ pounds</b>	<b>Small – 1 pound</b>
Water, 80°–90°F	1½ cups	1 cup	¾ cup
Extra virgin olive oil	2 tablespoons	1½ tablespoons	1 tablespoon
Sea salt	2 teaspoons	1½ teaspoons	1 teaspoon
Granulated sugar	1 teaspoon	¾ teaspoon	½ teaspoon
Bread flour	4 cups	3 cups	2 cups
Wheat bran (unprocessed coarse)	½ cup	⅓ cup	¼ cup
Yeast, active dry, instant or bread machine	2½ teaspoons	1¾ teaspoons	1¼ teaspoons
Sesame seeds, optional	1 tablespoon	2 teaspoons	1½ teaspoons

Place water, olive oil, salt, sugar, bread flour, wheat bran, and yeast, in order listed, in bread pan fitted with kneading paddle. Place the bread pan in the Cuisinart™ Convection Bread Maker. Press Menu and select French/Italian. Press Crust and select Medium (or to taste). Press Loaf and select dough size. Press Start to mix/knead, rise and bake. If desired, select Pause when pause signal sounds at end of second knead. Remove dough and kneading paddle. Shape dough into loaf and replace in bread pan. Sprinkle with sesame seeds. (If you are not there at this point, omit sesame seeds from recipe – it will not be as traditional, but will still be very good.) Press Start to continue rising and baking. Bread is done when end tone sounds and switches to Warm. When cycle is completed, remove bread from machine and transfer to wire rack to cool. Bread slices best when allowed to cool.

**To prepare using Rapid French/Italian cycle:** Select Rapid French/Italian, medium crust, loaf size.

Use rapid rise yeast in place of standard yeast in recipe and add vital wheat gluten (optional – aids in rise).

<b>Ingredients</b>	<b>Large – 2 pounds</b>	<b>Medium – 1½ pounds</b>	<b>Small – 1 pound</b>
Rapid rise yeast	3 teaspoons	2½ teaspoons	2 teaspoons
Vital wheat gluten (optional)	2 teaspoons	1½ teaspoons	1 teaspoon

*Nutritional information per serving (1 ounce):*

*Calories 62 (20% from fat) • carb. 11g • pro. 2g • fat 1g • sat. fat 0g • chol. 0mg • sod. 85mg • calc. 4mg • fiber 1g*

# Country French Loaf with Olives and Rosemary

French/Italian Bread Cycle

Delay Start Timer – Yes, but must be present to add olives

<b>Ingredients</b>	<b>Large – 2 pounds</b>	<b>Medium – 1½ pounds</b>	<b>Small – 1 pound</b>
<b>Water, 80°–90°F</b>	<b>1½ cups + 2 tablespoons</b>	<b>1¼ cups</b>	<b>¾ cup + 1 tablespoon</b>
<b>Extra virgin olive oil</b>	<b>1 tablespoon</b>	<b>2¼ teaspoons</b>	<b>1½ teaspoons</b>
<b>Sea salt</b>	<b>1½ teaspoons</b>	<b>1½ teaspoons</b>	<b>¾ teaspoon</b>
<b>Honey</b>	<b>1 teaspoon</b>	<b>¾ teaspoon</b>	<b>½ teaspoon</b>
<b>Dried rosemary</b>	<b>2 teaspoons</b>	<b>1½ teaspoons</b>	<b>1 teaspoon</b>
<b>Bread flour</b>	<b>2½ cups</b>	<b>1¾ cups + 2 tablespoons</b>	<b>1¼ cups</b>
<b>Barley flour</b>	<b>½ cup</b>	<b>6 tablespoons</b>	<b>¼ cup</b>
<b>Whole wheat flour</b>	<b>½ cup</b>	<b>6 tablespoons</b>	<b>¼ cup</b>
<b>Rye flour</b>	<b>⅓ cup</b>	<b>¼ cup</b>	<b>2 tablespoons + 2 teaspoons</b>
<b>Yeast, active dry, instant or bread machine</b>	<b>2¼ teaspoons</b>	<b>1¾ teaspoons</b>	<b>1½ teaspoons</b>
<b>Kalamata or Niçoise olives, drained, patted dry, pitted and halved before measuring</b>	<b>1 cup</b>	<b>¾ cup</b>	<b>½ cup</b>

Place water, olive oil, salt, honey, rosemary, bread flour, barley flour, whole wheat flour, rye flour, and yeast, in order listed, in Bread pan fitted with kneading paddle. Place the bread pan in the Cuisinart™ Convection Bread Maker. Press Menu and select French/Italian. Press Crust and select Medium (or to taste). Press Loaf and select dough size. Press Start to mix, knead, rise and bake, adding halved olives when Mix-in's signal sounds. If desired, select Pause when pause signal sounds at end of second knead. Remove dough and kneading paddle. Shape dough into loaf and replace in bread pan. Press Start to continue rising and baking. Bread is done when end tone sounds and switches to Warm. When cycle is completed, remove bread from machine and transfer to wire rack to cool. Bread slices best when allowed to cool.

**To prepare using Rapid French/Italian cycle:** Select Rapid French/Italian, medium crust or crust to taste, loaf size.

Use rapid rise yeast in place of standard yeast in recipe and add vital wheat gluten (optional – aids in rise).

<b>Ingredients</b>	<b>Large – 2 pounds</b>	<b>Medium – 1½ pounds</b>	<b>Small – 1 pound</b>
Rapid rise yeast	3 teaspoons	2½ teaspoons	2 teaspoons
Vital wheat gluten (optional)	2 teaspoons	1½ teaspoons	1 teaspoon

*Nutritional information per serving (1 ounce):*

*Calories 66 (33% from fat) • carb. 9g • pro. 2g • fat 2g • sat. fat 0g • chol. 0mg • sod. 114mg • calc. 3mg • fiber 1g*

# Herbed Dill French Bread

French/Italian Bread Cycle

Delay Start Timer - Yes

<b>Ingredients</b>	<b>Large – 2 pounds</b>	<b>Medium – 1½ pounds</b>	<b>Small – 1 pound</b>
Water, 80°–90°F	1½ cups	1¼ cups	1 cup
Extra virgin olive oil	3 tablespoons	2 tablespoons	1 tablespoon
Salt	1¼ teaspoons	1 teaspoon	¾ teaspoon
Bread flour	4 cups	3¾ cups	2 cups + 6 tablespoons
Dried dill weed	3 teaspoons	2 teaspoons	1½ teaspoons
Yeast, active dry, instant or bread machine	2¼ teaspoons	2¼ teaspoons	2 teaspoons

Place ingredients, in the order listed, in the bread pan fitted with the kneading paddle. Place the bread pan in the Cuisinart™ Convection Bread Maker. Press Menu and Select French/Italian. Press Crust and select Medium. Press Start to mix, knead, rise and bake. When pause signal sounds, remove dough and kneading paddle if desired, reshape dough and replace in bread pan. Press Start to continue. When cycle is completed, remove bread from machine and transfer to wire rack to cool. Bread slices best when allowed to cool.

**To prepare using Rapid French/Italian cycle:** Select Rapid French/Italian, medium crust or crust to taste, loaf size.

Use rapid rise yeast in place of standard yeast in recipe and add vital wheat gluten (optional – aids in rise).

<b>Ingredients</b>	<b>Large – 2 pounds</b>	<b>Medium – 1½ pounds</b>	<b>Small – 1 pound</b>
Rapid rise yeast	3 teaspoons	2½ teaspoons	2 teaspoons
Vital wheat gluten (optional)	2 teaspoons	1½ teaspoons	1 teaspoon

*Nutritional information per serving (1 ounce):*

*Calories 78 (17% from fat) • carb. 14g • pro. 2g • fat 1g • sat. fat 0g • chol. 0mg • sod. 99mg • calc. 5mg • fiber 1g*

# Parmesan Peppercorn French Bread

French/Italian Bread Cycle  
 Delay Start Timer - Not recommended

<b>Ingredients</b>	<b>Large – 2 pounds</b>	<b>Medium – 1½ pounds</b>	<b>Small – 1 pound</b>
Water, 80°–90°F	1¼ cups	1 cup	¾ cup
Olive oil	4 tablespoons	3 tablespoons	2¼ tablespoons
Salt	1¼ teaspoons	1 teaspoon	¾ teaspoon
Bread flour	3¾ cups	3 cups	2½ cups
Grated Parmesan cheese	¾ cup	½ cup	¼ cup
Freshly ground black pepper	¾ teaspoon	½ teaspoon	¼ teaspoon
Yeast, active dry, instant or bread machine	2¼ teaspoons	2¼ teaspoons	2 teaspoons

Place ingredients, in the order listed, in the bread pan fitted with the kneading paddle. Place the bread pan in the Cuisinart™ Convection Bread Maker. Press Menu and select French/Italian. Press Crust and select Light or Medium. Press Loaf and select dough size. Press Start to mix, knead, rise and bake. When pause signal sounds, remove dough and kneading paddle if desired, reshape dough and replace in bread pan. Press Start to continue. When cycle is completed, remove bread from machine and transfer to wire rack to cool. Bread slices best when allowed to cool.

**To prepare using Rapid French/Italian cycle:** Select Rapid French/Italian, medium crust or crust to taste, loaf size. Use rapid rise yeast in place of standard yeast in recipe and add vital wheat gluten (optional – aids in rise).

<b>Ingredients</b>	<b>Large – 2 pounds</b>	<b>Medium – 1½ pounds</b>	<b>Small – 1 pound</b>
Rapid rise yeast	3 teaspoons	2½ teaspoons	2 teaspoons
Vital wheat gluten (optional)	2 teaspoons	1½ teaspoons	1 teaspoon

*Nutritional information per serving (1 ounce):*

*Calories 78 (23% from fat) • carb. 13g • pro. 2g • fat 2g • sat. fat 0g • chol. 0mg • sod. 98mg • calc. 3mg • fiber 1g*

# Pignoli Bread

French/Italian Cycle  
Delay Start Timer - Yes

<b>Ingredients</b>	<b>Large – 2 pounds</b>	<b>Medium – 1½ pounds</b>	<b>Small – 1 pound</b>
Water, 80°–90°F	1½ cups	1 cup	1 cup
Extra virgin olive oil	3 tablespoons + 2 teaspoons	3 tablespoons	2 tablespoons
Sea salt	1¼ teaspoons	1 teaspoon	¾ teaspoon
Bread flour	4 cups	3 cups	2 cups + 6 tablespoons
Semolina flour	¼ cup	¼ cup	3 tablespoons
Pignoli/pine nuts	¾ cup	½ cup	½ cup
Yeast, active dry, instant or bread machine	2¼ teaspoons	2¼ teaspoons	2 teaspoons

Place water, oil, salt, bread flour, semolina flour, and yeast, in order listed, in bread pan fitted with kneading paddle. Press Menu and select French/Italian. Press Crust and select Medium (or to taste). Press Loaf and select dough size. Press Start to mix/knead, rise and bake, adding pignoli/pine nuts when Mix-in's signal sounds. If desired, select Pause when pause signal sounds at end of second knead. Remove dough and kneading paddle. Shape dough into loaf and replace in bread pan. Press Start to continue rising and baking. Bread is done when end tone sounds and unit switches to Warm. When cycle is completed, remove bread from machine and transfer to wire rack to cool. Bread slices best when allowed to cool.

**To prepare using Rapid French/Italian cycle:** Select Rapid French/Italian, medium crust or crust to taste, loaf size.

Use rapid rise yeast in place of standard yeast in recipe and add vital wheat gluten (optional – aids in rise).

<b>Ingredients</b>	<b>Large – 2 pounds</b>	<b>Medium – 1½ pounds</b>	<b>Small – 1 pound</b>
Rapid rise yeast	3 teaspoons	2½ teaspoons	2 teaspoons
Vital wheat gluten (optional)	2 teaspoons	1½ teaspoons	1 teaspoon

*Nutritional information per serving (1 ounce):*

*Calories 101 (32% from fat) • carb. 14g • pro. 3g • fat 4g • sat. fat 1g • chol. 0mg • sod. 98mg • calc. 4mg • fiber 1g*



# Semolina Bread with Fennel and Golden Raisins

French/Italian Cycle – Medium Crust

Delay Start Timer – yes, but must be present to add raisins

<b>Ingredients</b>	<b>Large – 2 pounds</b>	<b>Medium – 1½ pounds</b>	<b>Small – 1 pound</b>
Water, 80°–90°F	1½ cups	1¼ cups + 1 tablespoon	¾ cup + 2 tablespoons
Sea salt	2 teaspoons	1½ teaspoons	1 teaspoon
Fennel seed	2 teaspoons	1½ teaspoons	1 teaspoon
Granulated sugar	1 teaspoon	¾ teaspoon	½ teaspoon
Semolina flour	3 cups	2¼ cups	1½ cups
Bread flour	1 cup	¾ cup	½ cup
Yeast, active dry, instant or bread machine	2¼ teaspoons	1¼ teaspoons	1¼ teaspoons
Golden raisins	¾ cup	¾ cup	6 tablespoons

Place water, salt, fennel seed, sugar, semolina flour, bread flour, and yeast, in order listed, in bread pan fitted with kneading paddle. Place the bread pan in the Cuisinart™ Convection Bread Maker. Press Menu and select French/Italian. Press Crust and choose Medium (or to taste). Press Loaf and select dough size. Press Start to mix, knead, rise and bake, adding raisins when Mix-in's signal sounds. If desired, select Pause when pause signal sounds at end of second knead. Remove dough and kneading paddle. Shape dough into loaf and replace in bread pan. Press Start to continue rising and baking. Bread is done when end tone sounds and switches to Warm. When cycle is completed, remove bread from machine and transfer to wire rack to cool. Bread slices best when allowed to cool.

**To prepare using Rapid French/Italian cycle:** Select Rapid French/Italian, medium crust or crust to taste, loaf size.

Use rapid rise yeast in place of standard yeast in recipe and add vital wheat gluten (optional – aids in rise).

<b>Ingredients</b>	<b>Large – 2 pounds</b>	<b>Medium – 1½ pounds</b>	<b>Small – 1 pound</b>
Rapid rise yeast	3 teaspoons	2½ teaspoons	2 teaspoons
Vital wheat gluten (optional)	1 teaspoons	¾ teaspoon	½ teaspoon

*Nutritional information per serving (1 ounce):*

*Calories 84 (3% from fat) • carb. 18g • pro. 3g • fat 0g • sat. fat 0g • chol. 0mg • sod. 85mg*

# Banana Walnut Loaf

Quick Bread/Cake Cycle

Delay Start Timer - No

<b>Ingredients</b>	<b>Large – 2 pounds</b>	<b>Medium – 1½ pounds</b>	<b>Small – 1 pound</b>
Buttermilk, 80°–90°F	½ cup	⅓ cup + 1 tablespoon	¼ cup
Unsalted butter, ½-inch pieces at room temperature	¾ cup	½ cup	⅓ cup
Eggs, large, at room temperature*	2 eggs	2 eggs	1 egg
Pure vanilla extract	1½ teaspoons	1 teaspoon	1 teaspoon
Mashed bananas	1½ cups	1¼ cups	1 cup
Salt	1 teaspoon	¾ teaspoon	½ teaspoon
Granulated sugar	1½ cups	1 cup	¾ cup
Unbleached all-purpose flour	2½ cups	2 cups	1½ cups
Baking powder	1 teaspoon	¾ teaspoon	½ teaspoon
Baking soda	1½ teaspoons	1 teaspoon	¾ teaspoon
Chopped walnuts	¾ cup	¾ cup	½ cup

Place ingredients, in order listed, in bread pan fitted with kneading paddle. Place in Cuisinart™ Convection Bread Maker. Press Menu and select Quick Bread/Cake. Press Crust and select Medium (or to taste). Press Loaf and select dough size. Press Start to mix and bake. After batter has mixed for 4 minutes, stir sides and bottom of bread pan with rubber scraper to ensure complete mixing. Allow to continue mixing. When tone sounds, press Pause and remove kneading paddle if desired. Press Start to continue baking. When cycle is completed, remove bread from machine and transfer to wire rack to cool. Bread slices best when allowed to cool. If not serving after cooling, wrap in plastic wrap to maintain freshness when completely cooled.

\* Gently and safely warm cold eggs by placing whole eggs in a bowl and covering with moderately hot tap water for 10 minutes.

*Nutritional information per serving (1 ounce):*

*Calories 146 (40% from fat) • carb. 20g • pro. 2g • fat 7g • sat. fat 3g • chol. 24mg • sod. 141mg • calc. 13mg • fiber 1g*

# Carrot Cake Bread

Quick Bread/Cake Cycle

<b>Ingredients</b>	<b>Large – 2 pounds</b>	<b>Medium – 1½ pounds</b>	<b>Small – 1 pound</b>
Vegetable oil	6 tablespoons	4½ tablespoons	3 tablespoons
Eggs, large, at room temperature*	2	2	1
Granulated sugar	¾ cup	½ cup	½ cup
Brown sugar, packed	½ cup	¼ cup	2 tablespoons + 2 teaspoons
Crushed pineapple with juices (from can)	½ cup	¼ cup	2 tablespoons + 2 teaspoons
All-purpose flour	1¾ cups	1¼ cups	½ cup + ½ cup
Baking powder	1½ teaspoons	1 teaspoon	¾ teaspoon
Baking soda	¼ teaspoon	¼ teaspoon	¼ teaspoon
Salt	¼ teaspoon	¼ teaspoon	⅛ teaspoon
Unsweetened cocoa powder	1½ teaspoons	1 teaspoon	¾ teaspoon
Cinnamon	1 teaspoon	¾ teaspoon	½ teaspoon
Freshly grated carrots	1½ cups	1 cup	¾ cup
Chopped pecans or walnuts	½ cup	¼ cup	¼ cup
Golden raisins	½ cup	¼ cup	¼ cup
Vanilla extract	½ teaspoon	½ teaspoon	¼ teaspoon

Place ingredients, in order listed, in bread pan fitted with kneading paddle. Place in Cuisinart™ Convection Bread Maker. Press menu and select Quick Bread/Cake. Press Crust and select Medium (or to taste). Press Loaf and select dough size. Press Start to mix and bake. After batter has mixed for 4 minutes, stir sides and bottom of bread pan with rubber scraper to ensure complete mixing. Allow to continue mixing. When tone sounds, press Pause and remove kneading paddle if desired. Press Start to continue baking. When cycle is completed, remove bread from machine and transfer to wire rack to cool. Bread slices best when allowed to cool. If not serving after cooling, wrap in plastic wrap to maintain freshness when completely cooled.

\* Gently and safely warm cold eggs by placing whole eggs in a bowl and covering with moderately hot tap water for 10 minutes.

*Nutritional information per serving (1 ounce):*

*Calories 107 (34% from fat) • carb. 17g • pro. 1g • fat 4g • sat. fat 0g • chol. 13mg • sod. 46mg • calc. 11mg • fiber 1g*

# Date Nut Bread

Quick Bread/Cake Cycle

Delay Start Timer - No

<b>Ingredients</b>	<b>Large – 2 pounds</b>	<b>Medium – 1½ pounds</b>	<b>Small – 1 pound</b>
<b>Chopped dates</b>	<b>1 cup</b>	<b>¾ cup</b>	<b>½ cup</b>
<b>Unsalted butter, ½-inch pieces at room temperature</b>	<b>¾ cup</b>	<b>3 tablespoons</b>	<b>2 tablespoons</b>
<b>Boiling water</b>	<b>1 cup</b>	<b>¾ cup</b>	<b>½ cup</b>
<b>Granulated sugar</b>	<b>¾ cup</b>	<b>¾ cup</b>	<b>½ cup</b>
<b>All-purpose flour</b>	<b>1¾ cups</b>	<b>1½ cups</b>	<b>1½ cups</b>
<b>Baking soda</b>	<b>1 teaspoon</b>	<b>1 teaspoon</b>	<b>1 teaspoon</b>
<b>Baking powder</b>	<b>1 teaspoon</b>	<b>1 teaspoon</b>	<b>1 teaspoon</b>
<b>Salt</b>	<b>½ teaspoon</b>	<b>½ teaspoon</b>	<b>½ teaspoon</b>
<b>Pure vanilla extract</b>	<b>1 teaspoon</b>	<b>1 teaspoon</b>	<b>1 teaspoon</b>
<b>Chopped walnuts</b>	<b>½ cup</b>	<b>½ cup</b>	<b>½ cup</b>

Place ingredients, in order listed, in bread pan fitted with kneading paddle. Place in Cuisinart™ Convection Bread Maker. Press Menu and select Quick Bread/Cake. Press Crust and select Medium (or to taste). Press Loaf and select dough size. Press Start to mix and bake. After batter has mixed for 4 minutes, stir sides and bottom of bread pan with rubber scraper to ensure complete mixing. Allow to continue mixing. When tone sounds, press Pause and remove kneading paddle if desired. Press Start to continue baking. When cycle is completed, remove bread from machine and transfer to wire rack to cool. Bread slices best when allowed to cool. If not serving after cooling, wrap in plastic wrap to maintain freshness when completely cooled.

*Nutritional information per serving (1 ounce):*

*Calories 106 ( 26% from fat) • carb. 19g • pro. 2g • fat 3g • sat. fat 1g • chol. 4mg • sod. 157mg • calc. 6mg • fiber 1g*

# Lemon Poppy Seed Bread

Quick Bread/Cake Cycle  
Delay Start Timer - No

<b>Ingredients</b>	<b>Large – 2 pounds</b>	<b>Medium – 1½ pounds</b>	<b>Small – 1 pound</b>
Buttermilk (bring to room temperature)	¾ cup	¾ cup	½ cup
Fresh lemon juice	¼ cup	3 tablespoons	3 tablespoons
Lemon zest	2 teaspoons	2 teaspoons	2 teaspoons
Butter, melted and cooled	½ cup	½ cup	¼ cup
Eggs, large, at room temperature*	3	2	2
Pure vanilla extract	1 teaspoon	1 teaspoon	1 teaspoon
Granulated sugar	1½ cups	1 cup	¾ cup
All-purpose flour	2½ cups	1½ cups	1½ cups
Poppy seeds	1 teaspoon	1 teaspoon	1 teaspoon
Baking powder	1½ teaspoons	1¼ teaspoons	1¼ teaspoons

Place ingredients, in order listed, in bread pan fitted with kneading paddle. Place in Cuisinart™ Convection Bread Maker. Press Menu and select Quick Bread/Cake. Press Crust and select Medium or Dark crust. Press Loaf and select dough size. Press Start to mix and bake. After batter has mixed for 4 minutes, stir sides and bottom of bread pan with rubber scraper to ensure complete mixing. Allow to continue mixing. When tone sounds, press Pause and remove kneading paddle if desired. Press Start to continue baking. When cycle is completed, remove bread from machine and transfer to wire rack to cool. Bread slices best when allowed to cool. If not serving after cooling, wrap in plastic wrap to maintain freshness when completely cooled.

\* Gently and safely warm cold eggs by placing whole eggs in a bowl and covering with moderately hot tap water for 10 minutes.

*Nutritional information per serving (1 ounce):*

*Calories 111 (30% from fat) • carb. 18g • pro. 2g • fat 4g • sat. fat 2g • chol. 35mg • sod. 48mg • calc. 20mg • fiber 0g*

# Pumpkin Walnut Bread

Quick Bread/Cake Cycle

Delay Start Timer - No

<b><i>Ingredients</i></b>	<b><i>Large – 2 pounds</i></b>	<b><i>Medium – 1½ pounds</i></b>	<b><i>Small – 1 pound</i></b>
<b>Oil</b>	<b>¼ cup</b>	<b>3 tablespoons</b>	<b>2 tablespoons</b>
<b>Canned pumpkin</b>	<b>1 cup</b>	<b>¾ cup</b>	<b>½ cup</b>
<b>Eggs, large, at room temperature*</b>	<b>2</b>	<b>2</b>	<b>2</b>
<b>Brown sugar, packed</b>	<b>1 cup</b>	<b>¾ cup</b>	<b>½ cup</b>
<b>Unbleached all-purpose flour</b>	<b>2¼ cups</b>	<b>1¾ cups</b>	<b>1 cup + 2 tablespoons</b>
<b>Ground cinnamon</b>	<b>1 teaspoon</b>	<b>¾ teaspoon</b>	<b>½ teaspoon</b>
<b>Allspice</b>	<b>½ teaspoon</b>	<b>¼ teaspoon</b>	<b>¼ teaspoon</b>
<b>Nutmeg</b>	<b>¼ teaspoon</b>	<b>¼ teaspoon</b>	<b>¼ teaspoon</b>
<b>Salt</b>	<b>1 teaspoon</b>	<b>¾ teaspoon</b>	<b>½ teaspoon</b>
<b>Baking powder</b>	<b>1 teaspoon</b>	<b>¾ teaspoon</b>	<b>½ teaspoon</b>
<b>Walnuts</b>	<b>½ cup</b>	<b>⅓ cup</b>	<b>¼ cup</b>
<b>Dried cranberries</b>	<b>½ cup</b>	<b>⅓ cup</b>	<b>¼ cup</b>

Place ingredients, in order listed, in bread pan fitted with kneading paddle. Place in Cuisinart™ Convection Bread Maker. Press Menu and select Quick Bread/Cake. Press Crust and select Medium (or to taste). Press Loaf and select dough size. Press Start to mix and bake. After batter has mixed for 4 minutes, stir sides and bottom of bread pan with rubber scraper to ensure complete mixing. Allow to continue mixing. When tone sounds, press Pause and remove kneading paddle if desired. Press Start to continue baking. When cycle is completed, remove bread from machine and transfer to wire rack to cool. Bread slices best when allowed to cool. If not serving after cooling, wrap in plastic wrap to maintain freshness when completely cooled.

\* Gently and safely warm cold eggs by placing whole eggs in a bowl and covering with moderately hot tap water for 10 minutes.

*Nutritional information per serving (1 ounce):*

*Calories 109 (33% from fat) • carb. 14g • pro. 2g • fat 4g • sat. fat 1g • chol. 27mg • sod. 96mg • calc. 17mg • fiber 1g*

# Sour Cream Chocolate Tea Loaf

Quick Bread/Cake Cycle  
Delay Start Timer – No

<b>Ingredients</b>	<b>Large – 2 pounds</b>	<b>Medium – 1½ pounds</b>	<b>Small – 1 pound</b>
Milk, lowfat	¾ cup	½ cup + 1 tablespoon	6 tablespoons
Sour cream	¾ cup	½ cup	½ cup
Eggs, large, at room temperature*	2	2	1
Granulated sugar	¾ cup	½ cup	6 tablespoons
Brown sugar, packed	½ cup	½ cup	¼ cup
Unbleached all-purpose flour	1¾ cups	1½ cups	¾ cup + 2 tablespoons
Baking powder	1 teaspoon	¾ teaspoon	½ teaspoon
Baking soda	½ teaspoon	½ teaspoon	¼ teaspoon
Salt	½ teaspoon	½ teaspoon	¼ teaspoon
Vanilla extract	1 teaspoon	¾ teaspoon	½ teaspoon
Chocolate chips	¾ cup	½ cup	½ cup
Chopped walnuts	½ cup	½ cup	¼ cup
Dried tart cherries	¾ cup	¼ cup	3 tablespoons

Place ingredients, in order listed, in bread pan fitted with kneading paddle. Place in Cuisinart™ Convection Bread Maker. Press Menu and select Quick Bread/Cake. Press Crust and select Medium (or to taste). Press Loaf and select dough size. Press Start to mix and bake. After batter has mixed for 4 minutes, stir sides and bottom of bread pan with rubber scraper to ensure complete mixing. Allow to continue mixing. When tone sounds, press Pause and remove kneading paddle if desired. Press Start to continue baking. When cycle is completed, remove bread from machine and transfer to wire rack to cool. Bread slices best when allowed to cool. If not serving after cooling, wrap in plastic wrap to maintain freshness when completely cooled.

\* Gently and safely warm cold eggs by placing whole eggs in a bowl and covering with moderately hot tap water for 10 minutes.

*Nutritional information per serving (1 ounce):*

*Calories 110 (29% from fat) • carb. 18g • pro. 2g • fat 4g • sat. fat 1g • chol. 16mg • sod. 72mg • calc. 21mg • fiber 1g*

# Zucchini Bread

Quick Bread/Cake Cycle

Delay Start Timer - No

<b>Ingredients</b>	<b>Large – 2 pounds</b>	<b>Medium – 1½ pounds</b>	<b>Small – 1 pound</b>
Oil, vegetable	½ cup	⅓ cup	¼ cup
Zucchini, shredded	1 cup	¾ cup	½ cup
Eggs, large, at room temperature*	2	2	2
Brown sugar, packed	½ cup	⅓ cup	¼ cup
Granulated sugar	¼ cup	3 tablespoons	2 tablespoons
Unbleached all-purpose flour	2 cups	1½ cups	1 cup + 2 tablespoons
Ground cinnamon	1 teaspoon	¾ teaspoon	½ teaspoon
Allspice	½ teaspoon	¼ teaspoon	¼ teaspoon
Salt	1 teaspoon	¾ teaspoon	½ teaspoon
Baking soda	½ teaspoon	½ teaspoon	¼ teaspoon
Baking powder	½ teaspoon	½ teaspoon	¼ teaspoon
Walnuts	½ cup	⅓ cup	¼ cup
Raisins	½ cup	⅓ cup	¼ cup

Place ingredients, in order listed, in bread pan fitted with kneading paddle. Place in Cuisinart™ Convection Bread Maker. Press Menu and Select Quick Bread/Cake. Press Loaf and select dough size. Press Start to mix and bake. After batter has mixed for 4 minutes, stir sides and bottom of bread pan with rubber scraper to ensure complete mixing. Allow to continue mixing. When tone sounds, press Pause and remove kneading paddle if desired. Press Start to continue baking. When cycle is completed, remove bread from machine and transfer to wire rack to cool. Bread slices best when allowed to cool. If not serving after cooling, wrap in plastic wrap to maintain freshness when completely cooled.

\* Gently and safely warm cold eggs by placing whole eggs in a bowl and covering with moderately hot tap water for 10 minutes.

*Nutritional information per serving (1 ounce):*

*Calories 123 (38% from fat) • carb. 17g • pro. 2g • fat 5g • sat. fat 1g • chol. 27mg • sod. 125mg • calc. 15mg • fiber 1g*



# Nutty Low-Carb Bread

Low-Carb Cycle  
Delay Start Timer - No

<b><i>Ingredients</i></b>	<b><i>Large – 2 pounds</i></b>	<b><i>Medium – 1½ pounds</i></b>
<b>Water, 80°–90°F</b>	<b>1½ cups</b>	<b>1¼ cups</b>
<b>Heavy cream, 90°</b>	<b>2½ tablespoons</b>	<b>2 tablespoons</b>
<b>Molasses</b>	<b>1¼ tablespoons</b>	<b>1 tablespoon</b>
<b>Salt</b>	<b>¾ teaspoon</b>	<b>½ teaspoon</b>
<b>Whole wheat flour</b>	<b>1¼ cups</b>	<b>1 cup</b>
<b>Vital wheat gluten</b>	<b>¾ cup</b>	<b>½ cup</b>
<b>Barley flour</b>	<b>¾ cup</b>	<b>½ cup</b>
<b>Oat flour</b>	<b>¾ cup</b>	<b>½ cup</b>
<b>Almond flour</b>	<b>¾ cup</b>	<b>½ cup</b>
<b>Soy protein</b>	<b>2½ tablespoons</b>	<b>2 tablespoons</b>
<b>Mixed sunflower and pumpkin seeds</b>	<b>¾ cup</b>	<b>½ cup</b>
<b>Mixed, chopped walnuts and pecans</b>	<b>¾ cup</b>	<b>½ cup</b>
<b>Yeast, active dry, instant or bread machine</b>	<b>2¼ teaspoons</b>	<b>2¼ teaspoons</b>

Place ingredients, in the order listed, in the bread pan fitted with the kneading paddle. Place the bread pan in the Cuisinart™ Convection Bread Maker. Press Menu and select Low Carb. Press Crust and select Medium (or to taste). Press Loaf and choose dough size. Press Start to mix, knead, rise and bake. When cycle is completed, remove bread from machine and transfer to wire rack to cool. Bread slices best when allowed to cool.

*Nutritional information per serving (1 ounce):*

*Calories 55 (22% from fat) • carb. 7g • pro. 4g • fat 1g • sat. fat 0g • chol. 1mg • sod. 12mg • calc. 27mg • fiber 1g*

# Low-Carb Buttermilk Bread

Low-Carb Cycle  
Delay Start Timer - No

<b><i>Ingredients</i></b>	<b><i>Large – 2 pounds</i></b>	<b><i>Medium – 1½ pounds</i></b>
<b>Buttermilk, 80°–90°F</b>	<b>1½ cups</b>	<b>1¾ cups</b>
<b>Honey</b>	<b>1¼ tablespoons</b>	<b>1 tablespoon</b>
<b>Salt</b>	<b>¾ teaspoon</b>	<b>½ teaspoon</b>
<b>Whole wheat flour</b>	<b>1¼ cups</b>	<b>1 cup</b>
<b>Vital wheat gluten</b>	<b>¾ cup</b>	<b>½ cup</b>
<b>Barley flour</b>	<b>¾ cup</b>	<b>½ cup</b>
<b>Almond flour</b>	<b>¾ cup</b>	<b>½ cup</b>
<b>Soy protein</b>	<b>2½ tablespoons</b>	<b>2 tablespoons</b>
<b>Flax seed</b>	<b>2½ tablespoons</b>	<b>2 tablespoons</b>
<b>Yeast, active dry, instant or bread machine</b>	<b>2¼ teaspoons</b>	<b>2¼ teaspoons</b>

Place ingredients, in the order listed, in the bread pan fitted with the kneading paddle. Place the bread pan in the Cuisinart™ Convection Bread Maker. Press Menu and select Low Carb. Press Crust and select Medium (or to taste). Press Loaf and select dough size. Press Start to mix, knead, rise and bake. When cycle is completed, remove bread from machine and transfer to wire rack to cool. Bread slices best when allowed to cool.

*Nutritional information per serving (1 ounce):*

*Calories 55 (22% from fat) • carb. 7g • pro. 4g • fat 1g • sat. fat 0g • chol. 1mg • sod. 12mg • calc. 27mg • fiber 1g*

# Low-Carb Cinnamon Bread

Low-Carb Cycle  
Delay Start Timer- No

<b><i>Ingredients</i></b>	<b><i>Large – 2 pounds</i></b>	<b><i>Medium – 1½ pounds</i></b>
Low-carb vanilla yogurt	1¼ cups	1 cup
Heavy cream	2½ tablespoons	2 tablespoons
Molasses	1 tablespoon + 1 teaspoon	1 tablespoon
Salt	¾ teaspoon	½ teaspoon
Whole wheat flour	1¼ cups	1 cup
Vital wheat gluten	¾ cup	½ cup
Barley flour	½ cup	¼ cup
Oat flour	¾ cup	½ cup
Almond flour	1 cup	¾ cup
Chopped pecans	¾ cup	½ cup
Ground cinnamon	1¼ teaspoons	1 teaspoon
Pure vanilla extract	1¼ teaspoons	1 teaspoon
Yeast, active dry, instant or bread machine	2¼ teaspoons	2¼ teaspoons

Place ingredients, in the order listed, in the bread pan fitted with the kneading paddle. Place the bread pan in the Cuisinart™ Convection Bread Maker. Press Menu and select Low Carb. Press Crust and select Medium (or to taste). Press Loaf and select dough size. Press Start to mix, knead, rise and bake. When cycle is completed, remove bread from machine and transfer to wire rack to cool. Bread slices best when allowed to cool.

*Nutritional information per serving (1 ounce):*

*Calories 84 (37% from fat) • carb. 9g • pro. 5g • fat 4g • sat. fat 1g • chol. 2mg • sod. 52mg • calc. 49mg • fiber 1g*

# Low-Carb Molasses Bread

Low-Carb Cycle  
Delay Start Timer - No

<b><i>Ingredients</i></b>	<b><i>Large – 2 pounds</i></b>	<b><i>Medium – 1½ pounds</i></b>
<b>Water, 80°–90°F</b>	<b>1½ cups</b>	<b>1¼ cups</b>
<b>Heavy cream</b>	<b>2½ tablespoons</b>	<b>2 tablespoons</b>
<b>Molasses</b>	<b>1¼ tablespoons</b>	<b>1 tablespoon</b>
<b>Salt</b>	<b>¾ teaspoon</b>	<b>½ teaspoon</b>
<b>Whole wheat flour</b>	<b>1¼ cups</b>	<b>1 cup</b>
<b>Vital wheat gluten</b>	<b>¾ cup</b>	<b>½ cup</b>
<b>Barley flour</b>	<b>¾ cup</b>	<b>½ cup</b>
<b>Oat flour</b>	<b>¾ cup</b>	<b>½ cup</b>
<b>Almond flour</b>	<b>¾ cup</b>	<b>½ cup</b>
<b>Soy protein</b>	<b>2½ tablespoons</b>	<b>2 tablespoons</b>
<b>Yeast, active dry, instant or bread machine</b>	<b>2¼ teaspoons</b>	<b>2¼ teaspoons</b>

Place ingredients, in the order listed, in the bread pan fitted with the kneading paddle. Place the bread pan in the Cuisinart™ Convection Bread Maker. Press Menu and select Low Carb. Press Crust and select Medium (or to taste). Press Loaf and select dough size. Press Start to mix, knead, rise and bake. When cycle is completed, remove bread from machine and transfer to wire rack to cool. Bread slices best when allowed to cool.

*Nutritional information per serving (1 ounce):*

*Calories 55 (22% from fat) • carb. 7g • pro. 4g • fat 1g • sat. fat 0g • chol. 1mg • sod. 12mg • calc. 27mg • fiber 1g*

# Low-Carb Seed Bread

Low-Carb Cycle  
Delay Start Timer - No

<b><i>Ingredients</i></b>	<b><i>Large – 2 pounds</i></b>	<b><i>Medium – 1½ pounds</i></b>
Water, 80°–90°F	1 cup + 3 tablespoons	1 cup
Heavy cream, 90°	4 tablespoons	3 tablespoons
Splenda®	1 tablespoon + 1 teaspoon	1 tablespoon
Salt	¾ teaspoon	½ teaspoon
Flax seed oil	2½ tablespoons	2 tablespoons
Whole wheat flour	1¼ cups	1 cup
Almond flour	1 cup	¾ cup
Oat flour	¾ cup	½ cup
Brown rice flour	¾ cup	½ cup
Vital wheat gluten	¼ cup	2 tablespoons
Flax seeds	2½ tablespoons	2 tablespoons
Sesame seeds	2½ tablespoons	2 tablespoons
Poppy seeds	2½ teaspoons	2 teaspoons
Yeast, active dry, instant or bread machine	2½ teaspoons	2½ teaspoons

Place ingredients, in the order listed, in the bread pan fitted with the kneading paddle. Place the bread pan in the Cuisinart™ Convection Bread Maker. Press Menu and select Low Carb. Press Crust and select Medium (or to taste). Press Loaf and select dough size. Press Start to mix, knead, rise and bake. When cycle is completed, remove bread from machine and transfer to wire rack to cool. Bread slices best when allowed to cool.

*Nutritional information per serving (1 ounce):*

*Calories 80 (31% from fat) • carb. 10g • pro. 4g • fat 3g • sat. fat 1g • chol. 2mg • sod. 41mg • calc. 33mg • fiber 1g*

# Lower-Carb Bacon and Cheese Bread

Low-Carb Cycle  
Delay Start Timer - No

<b><i>Ingredients</i></b>	<b><i>Large – 2 pounds</i></b>	<b><i>Medium – 1½ pounds</i></b>
<b>Water, 80°–90°F</b>	<b>1 cup + 2 tablespoons</b>	<b>1¼ cups</b>
<b>Part-skim ricotta cheese</b>	<b>8 tablespoons</b>	<b>6 tablespoons</b>
<b>Salt</b>	<b>½ teaspoon</b>	<b>½ teaspoon</b>
<b>Whole wheat flour</b>	<b>¾ cup</b>	<b>½ cup</b>
<b>Barley flour</b>	<b>½ cup</b>	<b>½ cup</b>
<b>Soy flour</b>	<b>¾ cup</b>	<b>½ cup</b>
<b>Vital wheat gluten</b>	<b>¾ cup</b>	<b>½ cup</b>
<b>Oat flour</b>	<b>½ cup</b>	<b>½ cup</b>
<b>Almond flour</b>	<b>½ cup</b>	<b>¼ cup</b>
<b>Splenda® sweetener</b>	<b>1 tablespoon</b>	<b>2½ teaspoons</b>
<b>Shredded Cheddar cheese</b>	<b>4 ounces</b>	<b>3 ounces</b>
<b>Grated Asiago cheese</b>	<b>3 tablespoons</b>	<b>4½ teaspoons</b>
<b>Bacon, diced and cooked</b>	<b>8 medium slices</b>	<b>6 medium slices</b>
<b>Yeast, active dry, instant or bread machine</b>	<b>3 teaspoons</b>	<b>2¼ teaspoons</b>

Place ingredients, in the order listed, in the bread pan fitted with the kneading paddle. Place the bread pan in the Cuisinart™ Convection Bread Maker. Press Menu and select Low Carb. Press Crust and select Medium (or to taste). Press Loaf and select dough size. Press Start to mix, knead, rise and bake. When cycle is completed, remove bread from machine and transfer to wire rack to cool. Bread slices best when allowed to cool.

*Nutritional information per serving (1 ounce):*

*Calories 125 (41% from fat) • carb. 10g • pro. 9g • fat 6g • sat. fat 3g • chol. 13mg • sod. 159mg • calc. 95mg • fiber 2g*

# Cheesy Gluten-Free Loaf

Gluten-Free Cycle  
Delay Start Timer - No

<b>Ingredients</b>	<b>Large – 2 pounds</b>	<b>Medium – 1½ pounds</b>
Lowfat milk, 80°–90°F	1¾ cups	1½ cups
Olive oil	3 tablespoons	2 tablespoons
Eggs, large, at room temperature*	2	2
Honey	3 tablespoons	2 tablespoons
Cider vinegar	1 teaspoon	¾ teaspoon
Salt	1½ teaspoons	1 teaspoon
Brown rice flour	2 cups	1½ cups
Potato starch	1 cup	¾ cup
Tapioca flour	½ cup	½ cup
Garfava flour	¼ cup	2 tablespoons
Quinoa flour	¼ cup	2 tablespoons
Xanthan gum	2½ teaspoons	2 teaspoons
Gelatin	¾ teaspoon	½ teaspoon
Shredded provolone cheese	½ cup + 2 tablespoons	¼ cup
Shredded mozzarella cheese	½ cup + 2 tablespoons	¼ cup
Grated Parmesan cheese	¼ cup	2 tablespoons
Yeast, active dry, instant or bread machine	2¼ teaspoons	2¼ teaspoons

Add the milk, oil, eggs, honey and cider vinegar to the bread pan fitted with the kneading paddle. Stir the remaining ingredients together, except for the yeast, in a separate mixing bowl to incorporate and then add to the bread pan. Add yeast to the bread pan last. Place the bread pan in the Cuisinart™ Convection Bread Maker. Press Menu and select Gluten Free. Press Crust and select Medium (or to taste). Press Loaf and select dough size. Press Start to mix, knead, rise and bake. While the dough is kneading, scrape the sides of the bread pan with a rubber spatula to fully incorporate ingredients. When cycle is completed, remove bread from machine and transfer to wire rack to cool. Bread slices best when allowed to cool.

\* Gently and safely warm cold eggs by placing whole eggs in a bowl and covering with moderately hot tap water for 10 minutes.

Nutritional information per serving (1 ounce):

Calories 113 (27% from fat) • carb. 17g • pro. 4g • fat 4g • sat. fat 1g • chol. 23mg • sod. 153mg • calc. 62mg • fiber 1g

Download from [www.Somaterials.com](http://www.Somaterials.com). All Manuals Search And Download.

# Gluten-Free Apple, Cheddar, Walnut Bread

Gluten-Free Cycle  
Delay Start Timer - No

<b>Ingredients</b>	<b>Large – 2 pounds</b>	<b>Medium – 1½ pounds</b>
Lowfat milk, 80°–90°F	1½ cups	1 cup + 1 tablespoon
Unsalted butter, ½-inch pieces at room temperature	2 tablespoons	1½ tablespoons
Honey	2 tablespoons	1½ tablespoons
Eggs, large, at room temperature*	2	2
Cider vinegar	¼ teaspoon	¼ teaspoon
Salt	1½ teaspoons	1 teaspoon
Brown rice flour	1½ cups	1 cup + 1 tablespoon
Potato starch	¼ cup	½ cup
Tapioca flour	¼ cup	¼ cup
Quinoa flour	2 tablespoons	1½ tablespoons
Garfava flour	2 tablespoons	1½ tablespoons
Shredded Cheddar cheese	¼ cup	¼ cup
Chopped dried apples	¼ cup	¼ cup
Chopped walnuts	¼ cup	¼ cup
Xanthan gum	2 teaspoons	1½ teaspoons
Gelatin	½ teaspoon	½ teaspoon
Yeast, active dry, instant or bread machine	2¼ teaspoons	2¼ teaspoons

Add the milk, butter, honey, eggs and cider vinegar to the bread pan fitted with the kneading paddle. Stir the remaining ingredients together, except for the yeast, in a separate mixing bowl to incorporate and then add to the bread pan. Add yeast to the bread pan last. Place the bread pan in the Cuisinart™ Convection Bread Maker. Press Menu and select Gluten Free. Press Crust and select Medium (or to taste). Press Loaf and select dough size. Press start to mix, knead, rise and bake. While the dough is kneading, scrape the sides of the bread pan with a rubber spatula to fully incorporate ingredients. When cycle is completed, remove bread from machine and transfer to wire rack to cool. Bread slices best when allowed to cool.

\* Gently and safely warm cold eggs by placing whole eggs in a bowl and covering with moderately hot tap water for 10 minutes.

*Nutritional information per serving (1 ounce):*

*Calories 127 (29% from fat) • carb. 19g • pro. 5g • fat 4g • sat. fat 1g • chol. 25mg • sod. 195mg • calc. 71mg • fiber 1g*

Download from [www.Somanuals.com](http://www.Somanuals.com). All Manuals Search And Download.



# Gluten-Free Hazelnut Bread

Gluten-Free Cycle  
Delay Start Timer - No

<b>Ingredients</b>	<b>Large – 2 pounds</b>	<b>Medium – 1½ pounds</b>
Lowfat milk, 80°–90°F	1½ cups	1 cup + 1 tablespoon
Unsalted butter, ½-inch pieces at room temperature	4 tablespoons	3 tablespoons
Maple syrup (not pancake syrup)	4 tablespoons	3 tablespoons
Eggs, large, at room temperature*	2	1
Cider vinegar	1 teaspoon	¾ teaspoon
Salt	2 teaspoons	1½ teaspoons
Brown rice flour	1¾ cups	1½ cups
Cornstarch	1 cup	¾ cup
Potato starch	1 cup	¾ cup
Tapioca flour	½ cup	½ cup
Amaranth flour	½ cup	½ cup
Chopped hazelnuts	½ cup	½ cup
Xanthan gum	2¼ teaspoons	2 teaspoons
Gelatin	1¼ teaspoons	1 teaspoon
Yeast, active dry, instant or bread machine	2¼ teaspoons	2¼ teaspoons

Add the milk, butter, maple syrup, eggs and cider vinegar to the bread pan fitted with the kneading paddle. Stir the remaining ingredients together, except for the yeast, in a separate mixing bowl to incorporate and then add to the bread pan. Add yeast to the bread pan last. Place the bread pan in the Cuisinart™ Convection Bread Maker. Press Menu and select Gluten Free. Select dough size. Press Start to mix, knead, rise and bake. While the dough is kneading, scrape the sides of the bread pan with a rubber spatula to fully incorporate ingredients. When cycle is completed, remove bread from machine and transfer to wire rack to cool. Bread slices best when allowed to cool.

\* Gently and safely warm cold eggs by placing whole eggs in a bowl and covering with moderately hot tap water for 10 minutes.

*Nutritional information per serving (1 ounce):*

*Calories 117 (24% from fat) • carb. 20g • pro. 2g • fat 3g • sat. fat 1g • chol. 14mg • sod. 158mg • calc. 23mg • fiber 1g*

# Gluten-Free Molasses Walnut Bread

Gluten-Free Cycle  
Delay Start Timer - No

<b>Ingredients</b>	<b>Large – 2 pounds</b>	<b>Medium – 1½ pounds</b>
Lowfat milk, 80°–90°F	1¾ cups	1½ cups
Unsalted butter, ½-inch pieces at room temperature	4 tablespoons	3 tablespoons
Molasses	4 tablespoons	3 tablespoons
Eggs, large, at room temperature*	2	1
Cider vinegar	1 teaspoon	¾ teaspoon
Salt	2 teaspoons	1½ teaspoons
Garfava flour	1½ cups	1 cup
Tapioca flour	1 cup	¾ cup
Sorghum flour	¾ cup	½ cup
Cornstarch	¾ cups	½ cup + 1 tablespoon
Potato starch	¼ cup	2 tablespoons
Chopped walnuts	¾ cup	½ cup + 1 tablespoon
Xanthan gum	2¼ teaspoons	2 teaspoons
Gelatin	1¼ teaspoons	1 teaspoon
Yeast, active dry, instant or bread machine	2¼ teaspoons	2¼ teaspoons

Place the milk, butter, molasses, eggs and cider vinegar in the bread pan fitted with the kneading paddle. Stir the remaining ingredients together, except for the yeast, in a separate mixing bowl to incorporate and then add to the bread pan. Add the yeast to the bread pan last. Place the bread pan in the Cuisinart™ Convection Bread Maker. Press Menu button and Select Gluten Free. Select dough size. Press Start to mix, knead, rise and bake. While the dough is kneading, scrape the sides of the bread pan with a rubber spatula to fully incorporate ingredients. When cycle is completed, remove bread from machine and transfer to wire rack to cool. Bread slices best when allowed to cool.

\* Gently and safely warm cold eggs by placing whole eggs in a bowl and covering with moderately hot tap water for 10 minutes.

*Nutritional information per serving (1 ounce):*

*Calories 98 (33% from fat) • carb. 15g • pro. 3g • fat 4g • sat. fat 1g • chol. 14mg • sod. 161mg • calc. 45mg • fiber 2g*

# Gluten-Free Nut and Seed Bread

Gluten-Free Cycle  
Delay Start Timer - No

<b>Ingredients</b>	<b>Large – 2 pounds</b>	<b>Medium – 1½ pounds</b>
Lowfat milk, 80°–90°F	1¾ cups	1½ cups
Unsalted butter, ½-inch pieces at room temperature	4 tablespoons	3 tablespoons
Molasses	4 tablespoons	3 tablespoons
Eggs, large, at room temperature*	2	1
Cider vinegar	1 teaspoon	¾ teaspoon
Salt	2 teaspoons	1½ teaspoons
Garfava flour	1½ cups	1 cup
Tapioca flour	1 cup	¾ cup
Sorghum flour	¾ cup	½ cup
Cornstarch	¾ cups	½ cup + 1 tablespoon
Potato starch	¼ cup	2 tablespoons
Mixed chopped nuts + seeds (walnuts, pecans, sunflower seeds, pumpkin seeds)	¾ cup	½ cup + 1 tablespoon
Currants	¼ cup	2 tablespoons
Xanthan gum	2½ teaspoons	2 teaspoons
Gelatin	1¼ teaspoons	1 teaspoon
Yeast, active dry, instant or bread machine	2¼ teaspoons	2¼ teaspoons

Add the milk, butter, molasses, eggs and cider vinegar to the bread pan fitted with the kneading paddle. Stir the remaining ingredients together, except for the yeast, in a separate mixing bowl to incorporate and then add to the bread pan. Add the yeast to the bread pan last. Place the bread pan in the Cuisinart™ Convection Bread Maker. Press Menu and select Gluten Free. Select dough size. Press Start to mix, knead, rise and bake. While the dough is kneading, scrape the sides of the bread pan with a rubber spatula to fully incorporate ingredients. When cycle is completed, remove bread from machine and transfer to wire rack to cool. Bread slices best when allowed to cool.

\* Gently and safely warm cold eggs by placing whole eggs in a bowl and covering with moderately hot tap water for 10 minutes.

*Nutritional information per serving (1 ounce):*

*Calories 105 (34% from fat) • carb. 15g • pro. 3g • fat 4g • sat. fat 1g • chol. 14mg • sod. 161mg • calc. 46mg • fiber 2g*  
Download from [www.Somanuals.com](http://www.Somanuals.com). All Manuals Search And Download.

# Gluten-Free Rye Bread

Gluten-Free Cycle  
Delay Start Timer - No

<b>Ingredients</b>	<b>Large – 2 pounds</b>	<b>Medium – 1½ pounds</b>
Lowfat milk, 80°–90°F	2 cups	1½ cups
Unsalted butter, ½-inch pieces at room temperature	4 tablespoons	3 tablespoons
Eggs, large, at room temperature*	2	2
Cider vinegar	1 teaspoon	¾ teaspoon
Orange zest	1 teaspoon	¾ teaspoon
Salt	2 teaspoons	1½ teaspoons
Brown rice flour	1 cup	¾ cup
Garfava flour	1 cup	¾ cup
Cornstarch	½ cup	½ cup
Potato starch	½ cup	½ cup
Sorghum flour	½ cup	½ cup
Quinoa flour	¼ cup	2 tablespoons
Brown sugar, packed	¼ cup	2 tablespoons
Caraway seeds	5 teaspoons	1½ tablespoons
Xanthan gum	2½ teaspoons	2 teaspoons
Gelatin	¾ teaspoon	½ teaspoon
Yeast, active dry, instant or bread machine	2¼ teaspoons	2¼ teaspoons

Add the milk, butter, eggs and cider vinegar to the bread pan fitted with the kneading paddle. Stir the remaining ingredients together, except for the yeast, in a separate mixing bowl to incorporate and then add to the bread pan. Add the yeast to the bread pan last. Place the bread pan in the Cuisinart™ Convection Bread Maker. Press Menu and select Gluten Free. Select dough size. Press Start to mix, knead, rise and bake. While the dough is kneading, scrape the sides of the bread pan with a rubber spatula to fully incorporate ingredients. When cycle is completed, remove from bread pan and place on wire rack to cool completely for best slicing results.

\* Gently and safely warm cold eggs by placing whole eggs in a bowl and covering with moderately hot tap water for 10 minutes.

*Nutritional information per serving (1 ounce):*

*Calories 87 (26% from fat) • carb. 13g • pro. 3g • fat 3g • sat. fat 1g • chol. 23mg • sod. 163mg • calc. 29mg • fiber 2g*  
Download from [www.Somanuals.com](http://www.Somanuals.com). All Manuals Search And Download.

# French Bread Baguettes

Dough/Pizza Dough Cycle

Delay Start Timer – Yes

<b>Ingredients</b>	<b>Large – 2 pounds (3 loaves)</b>	<b>Medium – 1½ pounds (2 loaves)</b>	<b>Small – 1 pound (1 or 2 loaves)</b>
<b>Water, 80°–90°F</b>	<b>1½ cups</b>	<b>1½ cups</b>	<b>¾ cup</b>
<b>Salt</b>	<b>2 teaspoons</b>	<b>1½ teaspoons</b>	<b>1 teaspoon</b>
<b>Granulated sugar</b>	<b>1 teaspoon</b>	<b>¾ teaspoon</b>	<b>½ teaspoon</b>
<b>Bread flour</b>	<b>4 cups</b>	<b>3 cups</b>	<b>2 cups</b>
<b>Wheat germ</b>	<b>3 tablespoons</b>	<b>2 tablespoons</b>	<b>1½ tablespoons</b>
<b>Yeast, active dry, instant or bread machine</b>	<b>2¼ teaspoons</b>	<b>1¾ teaspoons</b>	<b>1¼ teaspoons</b>

Place all ingredients, in the order listed, in the bread pan fitted with the kneading paddle and place in Cuisinart™ Convection Bread Maker. Press Menu and select Dough/Pizza Dough. Select dough size. Press Start to mix, knead and rise. When cycle is completed, remove dough, punch to deflate and let rest 10 minutes.

Divide dough into appropriate number of equal pieces, depending upon size prepared. Shape each piece of dough into a long narrow baguette and place on a baking sheet that has been dusted with cornmeal. Cover loosely with plastic wrap and let rise 30 to 40 minutes. While baguettes rise, place a pan of hot water on the bottom rack of the oven and preheat oven to 425°F.

Dust dough gently with additional flour. Make 4 diagonal slashes in each loaf about ¼-inch deep using a serrated knife. Bake bread in preheated oven 25 to 30 minutes until browned and hollow-sounding when tapped. When cycle is completed, remove bread from machine and transfer to wire rack to cool. Bread slices best when allowed to cool.

*Nutritional information per serving (1 ounce):*

*Calories 72 (3% from fat) • carb. 15g • pro. 2g • fat 0g • sat. fat 0g • chol. 0mg • sod. 177mg • calc. 4mg • fiber 1g*

# Bread-Machine Brioche

Dough/Pizza Dough Cycle  
Delay Start Timer – No

<b>Ingredients</b>	<b>Large – 2 pounds</b>	<b>Medium – 1½ pounds</b>	<b>Small – 1 pound</b>
Milk, regular or lowfat, 80°–90°F	½ cup	½ cup	¼ cup
Eggs, large, at room temperature*	4	3	2
Unsalted butter, cut in ½-inch pieces, at room temperature	8 tablespoons	6 tablespoons	4 tablespoons
Granulated sugar	2 tablespoons	1½ tablespoons	1 tablespoon
Powdered milk	2 tablespoons	1½ tablespoons	1 tablespoon
Salt	1½ teaspoons	1 teaspoon	¾ teaspoon
Bread flour	3¾ cups	2¾ cups + 1 tablespoon	1¾ cups + 2 tablespoons
Yeast, active dry, instant or bread machine	3 teaspoons	2¼ teaspoons	1½ teaspoons
<b>Egg wash – 1 large egg beaten with 1 tablespoon water</b>			

Place the milk, eggs, butter, sugar, powdered milk, salt, bread flour, and yeast, in the order listed, in the bread pan fitted with the kneading paddle. Place the bread pan in the Cuisinart™ Convection Bread Maker. Press Menu and select Dough/Pizza Dough. Select dough size. Press Start to mix, knead and rise. This dough is very soft; it is recommended to scrape the bowl after 10 minutes of kneading to ensure even distribution and mixing of ingredients. When dough cycle is completed, remove dough, punch to deflate and transfer to a well-buttered bowl. Cover with plastic wrap and refrigerate for 1 hour.

Deflate dough and divide into the number and size brioches desired. For 1 or 1½-pound brioche, remove ¼ of the dough. Shape the larger piece into a ball and press into a buttered 6-inch brioche mold. Press a hole in the center about 1 inch deep. Shape the smaller piece into a ball and place in the center hole. For individual brioches, follow the same shaping directions, and place in ½-cup brioche molds. Cover loosely with plastic wrap and let rise in a warm (90°F), draft-free place about 45 minutes. Preheat oven to 350°F.

Brush brioche(s) with egg wash. Bake in preheated oven for 15 to 20 minutes for individual brioches, and about 20 to 30 minutes for larger brioches, until rich golden in color and hollow-sounding when tapped. Remove from pans and transfer to wire rack to cool. Bread slices best when allowed to cool.

\*Gently and safely warm cold eggs by placing whole eggs in a bowl and covering with moderately hot tap water for 10 minutes.

*Nutritional information per serving (one 2-ounce brioche):*

*Calories 198 (35% from fat) • carb. 26g • pro. 6g • fat 8g • sat. fat 4g • chol. 69mg • sod. 222mg • calc. 36mg • fiber 1g*

# Cheddar Breadsticks

Dough/Pizza Dough Cycle

Delay Start Timer- yes

<b>Ingredients</b>	<b>Large – 40-45 sticks</b>	<b>Medium – 30 sticks</b>	<b>Small – 25 sticks</b>
<b>Water, 80°–90°F</b>	<b>1 cup</b>	<b>¾ cup</b>	<b>½ cup</b>
<b>Olive oil</b>	<b>6 tablespoons</b>	<b>½ cup</b>	<b>¼ cup</b>
<b>Salt</b>	<b>2 teaspoons</b>	<b>1½ teaspoons</b>	<b>¾ teaspoon</b>
<b>Granulated sugar</b>	<b>1 teaspoon</b>	<b>½ teaspoon</b>	<b>½ teaspoon</b>
<b>Bread flour</b>	<b>3¾ cups</b>	<b>3 cups</b>	<b>2¼ cups</b>
<b>Shredded Cheddar cheese</b>	<b>1¼ cups</b>	<b>1 cup</b>	<b>¾ cup</b>
<b>Paprika</b>	<b>1¼ teaspoons</b>	<b>1 teaspoon</b>	<b>¾ teaspoon</b>
<b>Yeast, active dry, instant or bread machine</b>	<b>2¼ teaspoons</b>	<b>2¼ teaspoons</b>	<b>2 teaspoons</b>

Place ingredients, in the order listed, in the bread pan fitted with the kneading paddle. Place the bread pan in the Cuisinart™ Convection Bread Maker. Press Menu and select Dough/Pizza Dough. Select dough size. Press Start to mix, knead and rise. When cycle is completed, remove dough from machine and transfer to a lightly floured surface. Preheat oven to 375°. Line baking sheets with parchment paper.

Roll the dough out into a rectangle, ¼-inch thick, 10 inches long and between 16 and 24 inches wide, depending on the dough size. Roll the rectangle so that its width runs from left to right. With a pizza cutter or sharp knife, cut strips that are each ½-inch wide. Twist each strip so it resembles a cheese straw. Place on parchment-lined baking sheet and cover with plastic and allow to rest for about 30 minutes. Once breadsticks have rested, brush with olive oil and bake until golden – about 15 to 20 minutes. Transfer to a wire rack to cool slightly and serve.

*Nutritional information per breadstick:*

*Calories 83 (36% from fat) • carb. 10g • pro. 3g • fat 3g • sat. fat 0g • chol. 2mg • sod. 136mg • calc. 29mg • fiber 0g*

# Sweet Potato Cloverleaf Rolls

Dough/Pizza Dough Cycle  
Delay Start Timer - No

<b>Ingredients</b>	<b>2 lbs. Dough – 18 rolls</b>	<b>1½ lbs. Dough – 12 rolls</b>	<b>1 lb. Dough – 8 rolls</b>
Sweet potato, peeled and cubed	12–14 ounces (1 cup mashed)	8–10 ounces (¾ cup mashed)	6–8 ounces (½ cup mashed)
<b>Reserved cooking water from sweet potatoes</b>			
Nonfat dry milk	½ cup	⅓ cup	¼ cup
Brown sugar, firmly packed	¼ cup	3 tablespoons	2 tablespoons
Unsalted butter, at room temperature, cut in ¼-inch pieces	¼ cup	3 tablespoons	2 tablespoons
Kosher or sea salt	1¼ teaspoons	1 teaspoon	¾ teaspoon
Bread flour	4 cups	3 cups	2 cups
Yeast, active dry, instant or bread machine	3 teaspoons	2 teaspoons	1 teaspoon
<b>Cooking spray</b>			
<b>Milk for brushing tops of rolls</b>			

Place the cubed sweet potatoes in a saucepan with water to cover by 1 inch. Bring to a boil, then reduce heat and simmer until potatoes are tender, about 15 to 20 minutes. Drain, reserving cooking water. Measure out necessary amount of reserved cooking water for size of recipe being prepared: ½ cup – ⅓ cup – ¼ cup and let cool to 90°F. Mash sweet potatoes and measure out necessary amount for size recipe being prepared: 1 cup – ¾ cup – ½ cup.

Place measured mashed sweet potatoes, measured cooking liquid, nonfat dry milk, brown sugar, butter, salt, bread flour and yeast in baking pan fitted with kneading paddle. Press Menu and select Dough/Pizza Dough. Select dough size. Press Start to mix, knead and rise. When dough is ready, remove from baking pan and deflate. Divide into 18 – 12 – 9 equal portions, depending on size recipe prepared. Lightly coat regular muffin tin (18-hole, 12-hole, 9-hole) with cooking spray. Divide each dough ball into 3 equal portions. Roll each piece into a small ball. Arrange 3 small dough balls in each muffin cup. Cover with plastic wrap and let rise until doubled, about 30 to 40 minutes. Preheat oven to 375°F. When rolls have doubled in size, brush tops with milk. Bake in preheated oven for 20 to 25 minutes, until lightly browned and hollow-sounding when tapped. Remove from muffin tins and serve warm. May be made ahead and reheated to serve.

*Nutritional information per roll:*

*Calories 199 (16% from fat) • carb. 36g • pro. 6g • fat 3g • sat. fat 2g • chol. 8mg • sod. 223mg • calc. 55mg • fiber 2g*



# Molasses Whole Wheat Rolls with Currants and Pecans

Dough/Pizza Dough Cycle

Delay Start Timer - No

<b>Ingredients</b>	<b>2 lbs. Dough – 16 rolls</b>	<b>1½ lbs. Dough – 12 rolls</b>	<b>1 lb. Dough – 8-10 rolls</b>
Milk, lowfat	½ cup + 2 tablespoons	½ cup	7 tablespoons
Water, 80°–90°F	½ cup + 2 tablespoons	½ cup	7 tablespoons
Butter, ½-inch pieces at room temperature	1½ tablespoons	1 tablespoon	1 tablespoon
Salt	1 teaspoon	¾ teaspoon	½ teaspoon
Molasses	2 tablespoons	1½ tablespoons	1 tablespoon
Whole wheat flour	2 cups	1½ cups	1 cup
Bread flour	2 cups	1½ cups	1¼ cups
Currants	½ cup + 2 tablespoons	½ cup	6 tablespoons
Chopped pecans	½ cup + 2 tablespoons	½ cup	6 tablespoons
Yeast, active dry, instant or bread machine	2¼ teaspoons	2¼ teaspoons	2 teaspoons

Place ingredients, in the order listed, in the bread pan fitted with the kneading paddle. Place the bread pan in the Cuisinart™ Convection Bread Maker. Press Menu and select Dough/Pizza Dough. Select dough size. Press Start to mix, knead and rise. When cycle is completed, remove dough from machine and transfer to a lightly floured surface. Preheat oven to 350°F. Divide the dough into the number of pieces that the recipe size indicates. Roll each piece into an oval and place on a baking sheet lined with parchment paper and cover with plastic. Allow to rest for about 30 minutes until the rolls have about doubled in size. Once rolls have doubled, snip 2–3 vents along top of each roll with sharp scissors and dust with whole wheat flour. Bake in preheated oven for about 20 to 25 minutes, until they are a dark golden. Once finished, transfer rolls to a wire cooling rack.

*Nutritional information per roll:*

*Calories 181 (23% from fat) • carb. 31g • pro. 5g • fat 5g • sat. fat 1g • chol. 3mg • sod. 156mg • calc. 45mg • fiber 3g*

# Pizza Dough

Dough/Pizza Dough Cycle  
Delay Start Timer - Yes

<b><i>Ingredients</i></b>	<b><i>Large – 2 pounds</i></b>	<b><i>Medium – 1½ pounds</i></b>	<b><i>Small – 1 pound</i></b>
<b>Water, 80°–90°F</b>	<b>1½ cups</b>	<b>1 cup</b>	<b>¾ cup</b>
<b>Honey or sugar</b>	<b>1 teaspoon</b>	<b>¾ teaspoon</b>	<b>½ teaspoon</b>
<b>Salt (sea or kosher)</b>	<b>2 teaspoons</b>	<b>1½ teaspoons</b>	<b>1 teaspoon</b>
<b>Extra virgin olive oil</b>	<b>2 tablespoons</b>	<b>1½ tablespoons</b>	<b>1 tablespoon</b>
<b>Bread flour*</b>	<b>3¾ cups</b>	<b>2¾ cups</b>	<b>1¾ cups</b>
<b>Whole wheat flour*</b>	<b>¾ cup</b>	<b>9 tablespoons</b>	<b>6 tablespoons</b>
<b>Yeast, active dry, instant or bread machine</b>	<b>2¼ teaspoons</b>	<b>1¾ teaspoons</b>	<b>1¼ teaspoons</b>

Place ingredients, in order listed, in bread pan fitted with kneading paddle. Place the bread pan in the Cuisinart™ Convection Bread Maker. Select Dough/Pizza Dough. Select dough size. Press Start to mix, knead and rise. When Dough Cycle is completed, deflate dough and use to make your favorite pizza.

\* May use all bread flour rather than using part whole wheat flour.

*Nutritional information per serving (1 ounce):*

*Calories 73 (14% from fat) • carb. 13g • pro. 2g • fat 1g • sat. fat 0g • chol. 0mg • sod. 147mg • calc. 4mg • fiber 1g*

## Herb Focaccia

Dough/Pizza Dough Cycle  
Delay Start Timer - Yes

<b><i>Ingredients for crust</i></b>	<b><i>Large – 2 pounds</i></b>	<b><i>Medium – 1½ pounds</i></b>	<b><i>Small – 1 pound</i></b>
<b>Water, 80°–90°F</b>	<b>1½ cups</b>	<b>1½ cups</b>	<b>¾ cup</b>
<b>Extra virgin olive oil</b>	<b>3 tablespoons</b>	<b>2 tablespoons + 1 teaspoon</b>	<b>1½ tablespoons</b>
<b>Italian herb blend</b>	<b>1 tablespoon</b>	<b>2¼ teaspoons</b>	<b>1½ teaspoons</b>
<b>Salt</b>	<b>2 teaspoons</b>	<b>1½ teaspoons</b>	<b>1 teaspoon</b>
<b>Bread flour</b>	<b>4¾ cups</b>	<b>3 cups + 3 tablespoons</b>	<b>2¾ cups</b>
<b>Yeast, active dry, instant or bread machine</b>	<b>2 teaspoons</b>	<b>1½ teaspoons</b>	<b>1 teaspoon</b>

Place all ingredients, in the order listed, in the bread pan fitted with the kneading paddle. Place the bread pan in the Cuisinart™ Convection Bread Maker. Select Dough/Pizza Dough. Select dough size. Press Start to mix, knead and rise. When cycle is completed remove dough from pan, punch to deflate and let rest 10 minutes before continuing.

<b><i>Ingredients for topping</i></b>	<b><i>15x10-inch focaccia</i></b>	<b><i>12x8-inch focaccia</i></b>	<b><i>8x6-inch focaccia</i></b>
<b>Extra virgin olive oil</b>	<b>4 tablespoons</b>	<b>3 tablespoons</b>	<b>2 tablespoons</b>
<b>Coarse kosher or sea salt</b>	<b>1 teaspoon</b>	<b>¾ teaspoon</b>	<b>½ teaspoon</b>
<b>Freshly grated Asiago, Parmesan or Grana Padano® cheese</b>	<b>½ cup</b>	<b>½ cup</b>	<b>¼ cup</b>
<b>Chopped fresh herbs (parsley, basil, oregano, thyme, marjoram) – loosely packed</b>	<b>½ cup</b>	<b>¼ cup</b>	<b>3 tablespoons</b>

Brush a jelly-roll pan with olive oil and sprinkle with cornmeal. After dough has rested, roll out on a lightly floured surface to the appropriate size and place on prepared pan. Cover loosely with plastic wrap and let rise in a warm place until about doubled in size, about 40 to 50 minutes.

Preheat oven to 450°F. With oiled fingertips, press indentations into the dough about 1 inch apart and ½-inch deep. Drizzle with olive oil. Sprinkle evenly with salt, cheese and herbs. Place in preheated oven and bake until deep golden and puffed with a crispy crust, about 10 to 20 minutes, depending on size.

*Nutritional information per serving (1 ounce):*

*Calories 99 (34% from fat) • carb. 13g • pro. 3g • fat 4g • sat. fat 1g • chol. 1mg • sod. 213mg • calc. 23mg • fiber 0mg*

# Soft Pretzels

Dough/Pizza Dough Cycle

Delay Start Timer - Yes

<b>Ingredients</b>	<b>Large – 16 pretzels</b>	<b>Medium – 12 pretzels</b>	<b>Small – 8 pretzels</b>
<b>Water, 80°–90°F</b>	<b>1¼ cups</b>	<b>1 cup</b>	<b>¾ cup</b>
<b>Salt</b>	<b>1 tablespoon + ¼ cup</b>	<b>2 teaspoons</b>	<b>1½ teaspoons</b>
<b>Brown sugar, firmly packed</b>	<b>1 tablespoon + 1 teaspoon</b>	<b>1 tablespoon</b>	<b>2½ teaspoons</b>
<b>Bread flour</b>	<b>4 cups</b>	<b>3¾ cups</b>	<b>2 cups + 6 tablespoons</b>
<b>Yeast, active dry, instant or bread machine</b>	<b>2¼ teaspoons</b>	<b>2¼ teaspoons</b>	<b>2 teaspoons</b>
<b>Water</b>	<b>2 cups</b>	<b>2 cups</b>	<b>2 cups</b>
<b>Baking soda</b>	<b>2 tablespoons</b>	<b>2 tablespoons</b>	<b>2 tablespoons</b>

Place the water, salt, brown sugar, bread flour and yeast (do not add the second amount of water or the baking soda) in the bread pan fitted with the kneading paddle. Place the bread pan in the Cuisinart™ Convection Bread Maker. Press Menu and select Dough/Pizza Dough. Select dough size. Press Start to mix, knead and rise.

When cycle is completed, remove dough from machine and transfer to a floured surface. Divide dough into equal pieces according to the specific recipe size. Roll each ball into a thin rope. Twist dough into a pretzel shape and place on a baking sheet lined with parchment paper. Cover with plastic and allow pretzels to rest for about 20 to 30 minutes.

Place 2 inches of water in a wide 5½ quart sauté pan and bring to a boil. Preheat oven to 425°F. Place the 2 cups of water and baking soda in a small bowl, stir and reserve.

Once pretzels have rested and water comes to a boil, carefully slide pretzels into the boiling water one at a time, flipping each after 1½ minutes. Boil for 3 minutes total. Allow pretzels to drain on a wire cooling rack. Dip each pretzel into the stirred baking soda solution and place back on parchment-lined baking sheet. Bake in the oven until dark and golden, approximately 15 to 20 minutes. When pretzels are finished, transfer to a wire cooling rack.

*Nutritional information per 2-ounce pretzel:*

*Calories 141 (4% from fat) • carb. 28g • pro. 5g • fat 1g • sat. fat 0g • chol. 0mg • sod. 939mg • calc. 8mg • fiber 1g*

# Whole Wheat Kalamata Bread

Dough/Pizza Dough Cycle  
Delay Start Timer - No

<b>Ingredients</b>	<b>2 lbs. Dough – 16 rolls</b>	<b>1½ lbs. Dough – 12 rolls</b>	<b>1 lb. Dough – 8-10 rolls</b>
<b>Milk, 80°–90°F</b>	<b>½ cup + 2 tablespoons</b>	<b>½ cup</b>	<b>6 tablespoons</b>
<b>Water, 80°–90°F</b>	<b>7½ tablespoons</b>	<b>6 tablespoons</b>	<b>4½ tablespoons</b>
<b>Olive oil</b>	<b>1½ tablespoons</b>	<b>1 tablespoon</b>	<b>1 tablespoon</b>
<b>Salt</b>	<b>1 teaspoon</b>	<b>¾ teaspoon</b>	<b>½ teaspoon</b>
<b>Granulated sugar</b>	<b>1 tablespoon + 1 teaspoon</b>	<b>1 tablespoon</b>	<b>2 teaspoons</b>
<b>Whole wheat flour</b>	<b>2 cups</b>	<b>1½ cups</b>	<b>1 cup</b>
<b>Bread flour</b>	<b>2 cups</b>	<b>1½ cups</b>	<b>1¼ cups</b>
<b>Kalamata olives, pitted and chopped</b>	<b>½ cup + 2 tablespoons</b>	<b>½ cup</b>	<b>6 tablespoons</b>
<b>Herbes de Provence</b>	<b>1¼ teaspoons</b>	<b>1 teaspoon</b>	<b>¾ teaspoon</b>
<b>Yeast, active dry, instant or bread machine</b>	<b>2¼ teaspoons</b>	<b>2¼ teaspoons</b>	<b>2 teaspoons</b>

Place ingredients, in the order listed, in the bread pan fitted with the kneading paddle. Place the bread pan in the Cuisinart™ Convection Bread Maker. Press Menu and Select Dough/Pizza Dough. Select dough size. Press Start to mix, knead and rise.

When cycle is completed, remove dough from machine and transfer to a lightly floured surface. Preheat oven to 350°F. Divide the dough into the number of pieces that the recipe size indicates. Roll each piece into an oval and place on a baking sheet lined with parchment paper and cover with plastic. Allow to rest for about 30 minutes until the rolls have about doubled in size. Once rolls have doubled, cut 2 small slashes across each roll with a serrated knife. Dust with whole wheat flour and bake in preheated oven for about 20 to 25 minutes, until they are a dark golden. Once finished, transfer rolls to a wire cooling rack.

**Note:** This recipe can also be shaped into large oval loaves. Follow the same directions for the rolls but shape the dough into one large oval-shaped loaf. If you are using the 2-lb. recipe, divide the dough into two equal pieces and shape each loaf. Place on baking sheet lined with parchment and wrap the loaf/loaves in plastic. Allow to rest for 30 minutes, until the loaf has doubled in size. When loaf is ready, slash the top diagonally 3 times across the top. Bake in preheated 350°F oven for approximately 25 to 30 minutes until it is dark golden and sounds hollow when rapped on the bottom. Once finished, remove from pan and transfer to wire rack to cool. Bread slices best when allowed to cool.

*Nutritional information per serving (1 ounce):*

*Calories 83 (28% from fat) • carb. 13g • pro. 2g • fat 3g • sat. fat 0g • chol. 0mg • sod. 232mg • calc. 15mg • fiber 1g*

# Garlic, Herb, and Cheese Knots

Dough/Pizza Dough Cycle

Delay Start Timer - No

<b>Ingredients</b>	<b>2 lbs. Dough – 16 rolls</b>	<b>1½ lbs. Dough – 12 rolls</b>	<b>1 lb. Dough – 8-10 rolls</b>
<b>Garlic, chopped</b>	<b>2 cloves</b>	<b>2 cloves</b>	<b>2 cloves</b>
<b>Italian herb seasoning blend</b>	<b>2 teaspoons</b>	<b>2 teaspoons</b>	<b>2 teaspoons</b>
<b>Water</b>	<b>1½ cups</b>	<b>1 cup</b>	<b>¾ cup</b>
<b>Olive oil, divided</b>	<b>2 tablespoons + 1 tablespoon</b>	<b>1½ tablespoons + 1 tablespoon</b>	<b>1 tablespoon + 1 teaspoon</b>
<b>Salt</b>	<b>1¼ teaspoons</b>	<b>1 teaspoon</b>	<b>¾ teaspoon</b>
<b>Bread flour</b>	<b>4 cups</b>	<b>3 cups</b>	<b>2¼ cups</b>
<b>Dry powdered milk</b>	<b>½ cup</b>	<b>¼ cup</b>	<b>2 tablespoons</b>
<b>Potato flakes</b>	<b>¼ cup</b>	<b>2 tablespoons</b>	<b>1½ tablespoons</b>
<b>Asiago cheese, grated</b>	<b>2 ounces</b>	<b>1½ ounce</b>	<b>1 ounce</b>
<b>Yeast, active dry, instant or bread machine</b>	<b>2¼ teaspoons</b>	<b>2 teaspoons</b>	<b>1¾ teaspoons</b>

In a small bowl combine the chopped garlic, Italian herbs, and 1 tablespoon of olive oil and mix well. Cover with plastic and reserve.

Place the remaining ingredients, in the order listed, in the bread pan fitted with the kneading paddle. Place the bread pan in the Cuisinart™ Convection Bread Maker. Press Menu and select the Dough/Pizza Dough. Select dough size. Press Start to mix, knead and rise.

When cycle is completed, remove dough from machine and transfer to a lightly floured surface. Preheat oven to 350°F. Divide the dough into the number of pieces that the recipe size indicates. Roll each into a 10-inch rope and shape into a knot. Place on parchment-lined baking sheet, cover lightly with plastic wrap and allow to rest for approximately 30 minutes. Bake in preheated oven for 15 to 18 minutes until lightly browned. Brush hot knots lightly with reserved herb/olive oil mixture; let cool 5 to 10 minutes before serving.

*Nutritional information per roll:*

*Calories 213 (22% from fat) • carb. 35g • pro. 6g • fat 5g • sat. fat 1g • chol. 5mg • sod. 312mg • calc. 78mg • fiber 1g*

# Onion Rye Rolls

Dough/Pizza Dough Cycle  
Delay Start Timer - No

<b>Ingredients</b>	<b>2 lbs. Dough – 16 rolls</b>	<b>1½ lbs. Dough – 12 rolls</b>	<b>1 lb. Dough – 8-10 rolls</b>
Buttermilk	¾ cup	9 tablespoons	6 tablespoons
Water, 80°–90°F	½ cup	6 tablespoons	¼ cup
Molasses	2½ tablespoons	2 tablespoons	4 teaspoons
Vegetable oil	1½ tablespoons	1 tablespoon + ½ teaspoon	2½ teaspoons
Salt	1½ teaspoons	1 teaspoon	¾ teaspoon
Finely chopped onions, patted dry	½ cup	½ cup	¼ cup
Bread flour	2½ cups	1½ cups + 2 tablespoons	1¼ cups
Rye flour	1 cup	¾ cup	½ cup
Rye flakes (rye cereal)	½ cup	¼ cup	3 tablespoons
Potato starch	½ cup	¼ cup	3 tablespoons
Yeast, active dry, instant or bread machine	2¼ teaspoons	1¼ teaspoons	1¼ teaspoons
Caraway seeds	1½ tablespoons	1 tablespoon + 1 teaspoon	2¼ teaspoons
Vital gluten flour	1 tablespoon	2¼ teaspoons	1½ teaspoons

Place all ingredients, in the order listed, in the bread pan fitted with the kneading paddle and place in the Cuisinart™ Convection Bread Maker. Press Menu and select Dough/Pizza Dough. Select dough size. Press Start to mix, knead and rise. When cycle is completed, remove dough from machine and transfer to a lightly floured surface. Dough will be sticky. With floured hands, knead dough lightly until no longer sticky, adding flour as necessary. Divide dough into 16–12–8 equal pieces. Let rest 5 minutes.

Line baking sheets with parchment paper. With well-floured hands, roll each small piece of dough into a ball, then shape into a round about 3 inches in diameter. Arrange evenly spaced on baking sheet. Cover with plastic wrap and let rise until light and about doubled in size, about 30 to 40 minutes. Preheat oven to 400°F. Dust rolls with flour and cut 2 parallel or crossed slashes into each roll, about ¼-inch deep. Bake rolls for 20 to 25 minutes, until browned and crusty. Transfer to a rack to cool completely before serving. These rolls are best when allowed to cool completely, but may be reheated to serve warm. They are very good when sliced to make a sandwich or as a burger bun.

*Nutritional information per roll:*

*Calories 174 (31% from fat) • carb. 26g • pro. 4g • fat 6g • sat. fat 3g • chol. 37mg • sod. 267mg • calc. 23mg • fiber 1g*

# Peanut Butter and Chocolate Rolls

Dough/Pizza Dough Cycle

Delay Start Timer – Not recommended (can substitute dry milk; see Tips and Hints, page 15 of Instructions)

<b>Ingredients</b>	<b>16 rolls</b>	<b>12 rolls</b>	<b>8 rolls</b>
<b>Lowfat milk, 80°–90°F</b>	<b>1 cup</b>	<b>¾ cup</b>	<b>½ cup</b>
<b>Peanut butter, crunchy or creamy</b>	<b>½ cup</b>	<b>½ cup</b>	<b>½ cup</b>
<b>Brown sugar, packed</b>	<b>3 tablespoons</b>	<b>2 tablespoons + 1 teaspoon</b>	<b>1½ tablespoons</b>
<b>Salt</b>	<b>½ teaspoon</b>	<b>¾ teaspoon</b>	<b>¼ teaspoon</b>
<b>Bread flour</b>	<b>2¾ cups</b>	<b>2 cups</b>	<b>1 cup + 6 tablespoons</b>
<b>Yeast, active dry, instant or bread machine</b>	<b>2¼ teaspoons</b>	<b>1¾ teaspoons</b>	<b>1½ teaspoons</b>
<b>Semisweet chocolate morsels</b>	<b>1 cup</b>	<b>¾ cup</b>	<b>½ cup</b>

Place milk, peanut butter, brown sugar, salt, bread flour, and yeast in the bread pan fitted with the kneading paddle. Place the bread pan in the Cuisinart™ Convection Bread Maker. Press Menu and select Dough/Pizza Dough. Select dough size. Press Start to mix, knead and rise. When cycle is completed, remove dough and punch to deflate. Let rest 10 minutes.

Divide dough into 16–12–8 equal portions. Shape into balls, then flatten to ¾-inch-thick rounds. Arrange on parchment-lined baking sheets equally spaced, no closer than 1 inch apart. Cover with plastic wrap and let rise until nearly doubled, about 35 to 45 minutes. Preheat oven to 375°F.

Bake rolls until browned and hollow-sounding when tapped, about 25 minutes. Let cool 15 to 20 minutes on a rack before serving – they are very tempting just out of the oven, but the chocolate morsels may be hot enough to cause a burn.

*Nutritional information per serving (one roll):*

*Calories 219 (34% from fat) • carb. 31g • pro. 5g • fat 8g • sat. fat 3g • chol. 1mg • sod. 80mg • calc. 27mg • fiber 3g*



# Cinnamon Swirl Rolls

Dough/Pizza Dough Cycle  
 Delay Start Timer – No (contains raw eggs and fresh milk)

<b>Ingredients</b>	<b>2½ pounds dough = 24 cinnamon swirl rolls</b>		
Lowfat milk, warmed to 80°–90°F	¾ cup	½ cup	½ cup
Eggs, large, at room temperature*	3	2	1
Unsalted butter, cut in ½-inch pieces, at room temperature	6 tablespoons	4 tablespoons	3 tablespoons
Granulated sugar	½ cup	½ cup	¼ cup
Salt	1 teaspoon	¾ teaspoon	½ teaspoon
Vanilla extract	1½ teaspoons	1½ teaspoons	¾ teaspoon
Bread flour	4 cups	3 cups	2 cups
Cornstarch	¾ cup	½ cup	½ cup
Yeast, active dry, instant or bread machine	2½ teaspoons	1½ teaspoons	1½ teaspoons

\* Gently and safely warm cold eggs by placing whole eggs in a bowl and covering with moderately hot tap water for 10 minutes.

## Filling

<b>Ingredients</b>	<b>2½ pounds dough = 24 cinnamon swirl rolls</b>		
Brown sugar, packed	½ cup	½ cup	¼ cup
Granulated sugar	¼ cup	3 tablespoons	2 tablespoons
Cinnamon	2½ tablespoons	1 tablespoon + 2½ teaspoons	1 tablespoon + 1 teaspoon
Butter, unsalted, melted	4 tablespoons	3 tablespoons	2 tablespoons

Place the milk, eggs, unsalted butter, granulated sugar, salt, vanilla, flour, cornstarch, and yeast in the bread pan fitted with the kneading paddle. Place the bread pan in the Cuisinart™ Convection Bread Maker. Select Dough/Pizza Dough. Select dough size. Press Start to mix, knead and rise. When cycle is completed remove dough and punch to deflate. For large and medium recipes, divide into 2 equal portions. Let rest 10 minutes. Place the filling ingredients in a small bowl and stir with a whisk until well blended; reserve. Lightly coat 2 ten-inch round/2 nine-inch round/1 ten-inch round cake pan(s) with cooking spray and reserve.

Roll the dough out into rectangles 12 inches wide and ½-inch thick. Brush each rectangle with melted butter to within one inch of one long side and to the ends of the other 3 sides, and sprinkle evenly with sugar/cinnamon mixture. Roll as for a jelly roll, ending with the unbuttered side. Pinch along long side to seal. Cut with a serrated knife into 12/9/6 equal portions. Arrange in prepared pans, cover with plastic wrap, and let rise 35 to 40 minutes. Preheat oven to 350°F.

Bake for 25 to 30 minutes, until puffed with golden tops, and hollow-sounding when tapped.

Combine frosting ingredients and stir with a whisk until smooth (this may also be done in a food processor fitted with the metal “s” blade, or with a hand mixer).

Let cool 20 to 25 minutes before frosting. Spread or drizzle cream cheese frosting to taste.

## Cream Cheese Frosting

<i><b>Ingredients</b></i>	<i><b>2½ pounds dough = 24 cinnamon swirl rolls</b></i>		
<b>Lowfat cream cheese</b>	<b>4 ounces</b>	<b>3 ounces</b>	<b>2 ounces</b>
<b>Unsalted butter, at room temperature</b>	<b>¼ cup</b>	<b>3 tablespoons</b>	<b>2 tablespoons</b>
<b>Vanilla extract</b>	<b>1 teaspoon</b>	<b>¾ teaspoon</b>	<b>½ teaspoon</b>
<b>Powdered sugar, sifted</b>	<b>1½ cups</b>	<b>1½ cups</b>	<b>¾ cup</b>
<b>Lowfat milk</b>	<b>1 tablespoon</b>	<b>2¼ teaspoons</b>	<b>1½ teaspoons</b>

*Nutritional information per serving (one roll):*

*Calories 239 (31% from fat) • carb. 37g • pro. 4g • fat 8g • sat. fat 5g • chol. 43mg • sod. 138mg • calc. 36mg • fiber 1g*

# Basic Sweet Dough

Dough/Pizza Dough  
 Delay Start Timer – No (contains fresh dairy products and eggs)

<b>Ingredients</b>	<b>2 pounds dough</b>	<b>1½ pounds dough</b>	<b>1 pound dough</b>
<b>Eggs, large, at room temperature*</b>	<b>3</b>	<b>2</b>	<b>1</b>
<b>Water, 80°–90°F</b>	<b>¼ cup + 3½ tablespoons</b>	<b>6 tablespoons</b>	<b>4½ tablespoons</b>
<b>Sour cream</b>	<b>6 tablespoons</b>	<b>4½ tablespoons</b>	<b>3 tablespoons</b>
<b>Unsalted butter, at room temperature, cut in ½-inch pieces</b>	<b>6 tablespoons</b>	<b>4½ tablespoons</b>	<b>3 tablespoons + 2 teaspoons</b>
<b>Granulated sugar</b>	<b>6 tablespoons</b>	<b>4½ tablespoons</b>	<b>3 tablespoons</b>
<b>Bread flour</b>	<b>4¼ cups</b>	<b>3 cups + 1 tablespoon</b>	<b>2½ cups</b>
<b>Yeast, active dry, instant or bread machine</b>	<b>1 tablespoon</b>	<b>2¼ teaspoons</b>	<b>1½ teaspoons</b>

Place all ingredients, in order shown, in bread pan fitted with the kneading paddle. Place the bread pan in the Cuisinart™ Convection Bread Maker. Press Menu and select Dough/Pizza Dough. Press Start to mix, knead and rise dough. When dough has risen and cycle is completed, remove dough from pan, punch to deflate and let rest 10 minutes before continuing. This dough may be used to make your favorite sweet breakfast/brunch treats.

\* Gently and safely warm cold eggs by placing whole eggs in a bowl and covering with moderately hot tap water for 10 minutes.

*Nutritional information per serving (one ounce):*

*Calories 105 (31% from fat) • carb. 15g • pro. 3g • fat 4g • sat. fat 2g • chol. 15mg • sod. 8mg • calc. 10mg • fiber 0g*

## Apricot Cheese Danish Braid

<b>Ingredients</b>	<b>2 pounds = 2 Danish Braids</b>	<b>1½ pounds = 1 Braid</b>	<b>1 pound = 1 Braid</b>
<b>Basic Sweet Dough, page 63</b>			
<b>Cream cheese, cut in ½-inch pieces, at room temperature</b>	<b>8 ounces</b>	<b>6 ounces</b>	<b>4 ounces</b>
<b>Granulated sugar</b>	<b>¼ cup</b>	<b>3 tablespoons</b>	<b>2 tablespoons</b>
<b>Cornstarch</b>	<b>2 tablespoons</b>	<b>4 teaspoons</b>	<b>1 tablespoon</b>
<b>Egg, large, at room temperature*</b>	<b>1</b>	<b>3 tablespoons (1 medium)</b>	<b>2 tablespoons (½ beaten egg – 1 small)</b>
<b>Pure vanilla extract</b>	<b>1 teaspoon</b>	<b>¾ teaspoon</b>	<b>½ teaspoon</b>
<b>Apricot preserves</b>	<b>12 tablespoons, divided</b>	<b>9 tablespoons, divided</b>	<b>6 tablespoons</b>
<b>Egg wash – 1 large egg beaten with 1 tablespoon water</b>			

Place cream cheese, sugar, cornstarch, egg, and vanilla in a medium bowl and whisk until smooth (this may also be done in a food processor fitted with the metal “s” blade or with a hand mixer). Cover and refrigerate until ready to use.

For 2-pound and 1½-pound recipes, divide dough into 2 equal pieces. Roll out dough into a rectangle 18x12 inches for 2-pound size or 14x10-inches for 1½-pound size. Place on a parchment-lined baking sheet. Spread cream cheese filling over the center third (lengthwise portion) of rectangle and top with 6 (4½) tablespoons apricot preserves. Cut 1-inch wide strips from edge of filling to edge of dough along 18-inch sides. Begin braid by folding top row toward filling. Alternately fold strips at an angle from each side across filling toward opposite side. Fold bottom row toward filling and finish by stretching last strip and tucking under. Preheat oven to 350°F.

Cover and let rise until nearly doubled. Brush with egg wash. Bake in preheated 350°F oven for 30 to 40 minutes until golden brown and filling is set. Remove from oven. Slide parchment and braid onto a wire rack, and pull parchment out from under the braid. Allow to cool. Serve plain, dust with powdered sugar, or drizzle with vanilla glaze.

\* Gently and safely warm cold eggs by placing whole eggs in a bowl and covering with moderately hot tap water for 10 minutes.

## Vanilla Glaze

Place ½ cup sifted powdered sugar in a bowl with 2 teaspoons powdered sugar and ½ teaspoon vanilla extract. Add milk, a few drops at a time, until mixture is a consistency that can be drizzled.

*Nutritional information per serving (1 ounce):*

*Calories 158 (35% from fat) • carb. 22g • pro. 4g • fat 6g • sat. fat 3g • chol. 41mg • sod. 39mg • calc. 17mg • fiber 1g*

# Artisan Dough Cycle

When using the Artisan Dough cycle, please remember that for this cycle, the liquids and other ingredients should be cool. Follow the temperature recommendations of the recipe. It is also important that the unit not be in a sunny, warm place while the Artisan Dough cycle is being used. The idea is to have long, cool rises to develop the flavors and texture of the dough.

## Rustic Baguette

Artisan Dough Cycle

<b><i>Ingredients</i></b>	<b><i>About 1½ pounds dough</i></b>
<b>Water, 60°–70°F</b>	<b>1 cup</b>
<b>Extra virgin olive oil</b>	<b>1 tablespoon</b>
<b>Sea salt</b>	<b>½ teaspoons</b>
<b>Granulated sugar</b>	<b>1 teaspoon</b>
<b>Bread flour</b>	<b>3 cups</b>
<b>Whole wheat flour</b>	<b>½ cup</b>
<b>Rye flour</b>	<b>2 tablespoons</b>
<b>Yeast, active dry, instant or bread machine</b>	<b>2 teaspoons</b>

Place all ingredients, in the order listed, in the bread pan fitted with the kneading paddle. Place the bread pan in the Cuisinart™ Convection Bread Maker. Press Menu and select Artisan Dough. Press Start to mix, knead and rise. When cycle is completed remove dough from pan and transfer to a well-floured surface. Punch to deflate and let rest 10 minutes before continuing.

Preheat oven to 425°F. Divide dough into 2 equal pieces. Roll out into long cylindrical baguette shape. Place on baking sheet lined with parchment, cover with plastic and allow to rest for about 30 minutes.

Slash the baguettes diagonally 3 times evenly across the top of the loaf. If desired, dust with additional bread flour. Bake in preheated oven until golden and even, about 25 to 30 minutes. Bread will sound hollow when tapped. Remove from pan and transfer to wire rack to cool. Bread slices best when allowed to cool.

*Nutritional information per serving (1 ounce):*

*Calories 76 (11% from fat) • carb. 14g • pro. 2g • fat 1g • sat. fat 0g • chol. 0mg • sod. 147mg • calc. 4mg • fiber 1g*

Download from [www.Somanuals.com](http://www.Somanuals.com). All Manuals Search And Download.

# Artisan Focaccia/Pizza

## Artisan Dough Cycle

<b><i>Ingredients</i></b>	<b><i>About 1½ pounds dough</i></b>
<b>Water, 60°–70°F</b>	<b>1½ cups</b>
<b>Sea salt</b>	<b>2½ teaspoons</b>
<b>Honey</b>	<b>2 teaspoons</b>
<b>Bread flour</b>	<b>3½ cups</b>
<b>Semolina flour</b>	<b>½ cup</b>
<b>Yeast, active dry, instant or bread machine</b>	<b>2 teaspoons</b>

Place all ingredients, in the order listed, in the bread pan fitted with the kneading paddle. Place the bread pan in the Cuisinart™ Convection Bread Maker. Press Menu and select Artisan Dough. Press Start to mix, knead and rise. When cycle is complete, remove dough from pan and transfer to a well-floured surface. Punch to deflate and let rest 10 minutes before continuing.

Follow the similar recipes in the Dough/Pizza Dough section for preparation of focaccia.

*Nutritional information per serving (1 ounce):*

*Calories 58 (4% from fat) • carb. 12g • pro. 2g • fat 0g • sat. fat 0g • chol. 0mg • sod. 184mg • calc. 3mg • fiber 0g*

# Buttermilk Whole Wheat Walnut Boule

Artisan Dough Cycle

Time Delay - No

## ***Ingredients for 24-hour poolish (starter)***

***Large 2¾ pounds***

**Water – cool**

**½ cup**

**Active dry or instant yeast**

**½ teaspoon**

**Bread flour**

**½ cup**

**Whole wheat flour**

**½ cup**

Place ingredients in a medium mixing bowl and stir vigorously until the mixture resembles a thick batter. Scrape the sides of the bowl with a rubber spatula and cover the bowl with plastic wrap. Place in a moderately warm, draft-free location until the poolish has doubled. Allow the poolish to ferment for 12 to 24 hours at room temperature before using.

## ***Ingredients***

***Large 2¾ pounds***

**Water, 60°–70°F**

**1 cup + 1 tablespoon**

**Buttermilk, 60°–70°F**

**1 cup + 1 tablespoon**

**Sea salt**

**¾ teaspoon**

**Honey**

**2 tablespoons**

**Bread flour**

**2¾ cups**

**Whole wheat flour**

**2¾ cups**

**Chopped walnuts**

**¾ cup**

**Yeast, active dry, instant or bread machine**

**½ teaspoon**

When the poolish is ready, add remaining ingredients, in the order listed, to the bread pan fitted with the kneading paddle. Place the bread pan in the Cuisinart™ Convection Bread Maker. Press Menu and select Artisan Dough. Press Start to mix, knead and rise. When cycle is completed remove dough from pan and transfer to a well-floured surface. Punch to deflate and let rest 10 minutes before continuing.

Preheat oven to 375°F.

Divide the dough into 2 pieces. Shape each piece into a round. With the dough cupped in your hands, roll, seamed edges down, on the counter until the underside is smooth. Place on baking sheets lined with parchment and cover boules with plastic. Allow to rest for about 30 to 40 minutes until the boules have about doubled in size.

Dust dough round with whole wheat flour and cut a cross approximately 3 inches long in the top of the loaf, cutting about ¼-inch into the loaf. Bake in preheated oven for about 25 to 30 minutes, until they are a dark golden and sound hollow when tapped. When finished, remove from pan and transfer to wire rack to cool. Bread slices best when allowed to cool.

*Nutritional information per serving (1 ounce):*

*Calories 79 (18% from fat) • carb. 14g • pro. 3g • fat 2g • sat. fat 0g • chol. 0mg • sod. 47mg • calc. 13mg • fiber 1g*



# Cranberry Pistachio Boule

## Artisan Dough Cycle

<b><i>Ingredients</i></b>	<b><i>2 Pounds</i></b>
<b>Water, 60°–70°F</b>	<b>1½ cups</b>
<b>Maple syrup (not pancake syrup)</b>	<b>3 tablespoons</b>
<b>Walnut or almond oil</b>	<b>2 tablespoons</b>
<b>Salt</b>	<b>2 teaspoons</b>
<b>Bread flour</b>	<b>1¾ cups</b>
<b>Whole wheat flour</b>	<b>1¾ cups</b>
<b>Yeast, active dry, or instant</b>	<b>2¼ teaspoons</b>
<b>Shelled pistachios or walnuts</b>	<b>¾ cup</b>
<b>Dried cranberries</b>	<b>¾ cup</b>

Place all ingredients, in the order listed, in the bread pan fitted with the kneading paddle. Press Menu and select Artisan Dough. Press Start to mix, knead and rise. When cycle is completed remove dough from pan and transfer to a well-floured surface. Punch to deflate and let rest 10 minutes before continuing.

Line a baking sheet with parchment paper or a nonstick baking liner and dust with cornmeal. Shape dough into a round. With the dough cupped in your hands, roll, seamed edges down, on the counter until the underside is smooth. Flatten into a round, 10 inches in diameter. Cover with plastic wrap and let rise until doubled in size, about 60 minutes.

Fifteen minutes before baking, preheat oven to 425°F. Dust dough round with flour and cut a cross approximately 3 inches long in the top of the loaf, cutting about ¼ inch into the loaf. Place in the hot oven and bake for 15 minutes. Reduce oven temperature to 375°F. Bake for an additional 20 minutes, until the bread is a rich brown, and sounds hollow when tapped. When finished, remove from pan and transfer to wire rack to cool. Bread slices best when allowed to cool.

*Nutritional information per serving (1 ounce):*

*Calories 87 (28% from fat) • carb. 12g • pro. 2g • fat 3g • sat. fat 0g • chol. 0mg • sod. 148mg • calc. 10mg • fiber 1g*

# Hazelnut and Apricot Artisan Loaf

## Artisan Dough Cycle

<b><i>Ingredients</i></b>	<b><i>About 2 pounds dough</i></b>
<b>Water, 60°–70°F</b>	<b>1½ cups</b>
<b>Sea salt</b>	<b>2 teaspoons</b>
<b>Honey</b>	<b>1 tablespoon</b>
<b>Bread flour</b>	<b>2⅞ cups</b>
<b>Whole wheat flour</b>	<b>½ cup</b>
<b>Barley flour</b>	<b>½ cup</b>
<b>Yeast, active dry, or instant</b>	<b>2½ teaspoons</b>
<b>Hazelnuts</b>	<b>½ cup</b>
<b>Dried apricots, chopped</b>	<b>¾ cup</b>

Place all the water, sea salt, honey, bread flour, whole wheat flour, barley flour, and yeast, in the order listed, in the bread pan fitted with the kneading paddle. Place the bread pan in the Cuisinart™ Convection Bread Maker. Press Menu and select Artisan Dough. Press Start to mix, knead and rise. When cycle is completed remove dough from pan and transfer to a well-floured surface. Punch to deflate and let rest 10 minutes before continuing.

Preheat oven to 425°F.

Roll the dough into a rectangle that is approximately 16x12 inches. Sprinkle the hazelnuts and apricots evenly along the surface of the dough. Roll dough into a cylindrical shape that is 3 inches wide. Pinch the ends to shape the loaf. Place on baking sheet lined with parchment, cover with plastic and let it rest for about 30 minutes.

Slash the loaf diagonally 4 to 5 times along the top of the loaf and dust lightly with flour. Bake in preheated oven until golden and even, about 25 to 30 minutes. When finished, remove from pan and transfer to wire rack to cool. Bread slices best when allowed to cool.

*Nutritional information per service (1 ounce):*

*Calories 65 (18% from fat) • carb. 12g • pro. 2g • fat 1g • sat. fat 0g • chol. 0mg • sod. 148mg • calc. 7mg • fiber 1g*

# Semolina Loaf

Artisan Dough Cycle

<b><i>Ingredients</i></b>	<b><i>About 2 pounds dough</i></b>
<b>Water, 60°–70°F</b>	<b>2 cups</b>
<b>Olive oil</b>	<b>3 tablespoons</b>
<b>Sea salt</b>	<b>1½ teaspoons</b>
<b>Granulated sugar</b>	<b>4 teaspoons</b>
<b>Bread flour</b>	<b>2 cups</b>
<b>Semolina flour</b>	<b>2 cups</b>
<b>Vital wheat gluten</b>	<b>4 teaspoons</b>
<b>Yeast, active dry, or instant</b>	<b>2 teaspoons</b>

Place all ingredients, in the order listed, in the bread pan fitted with the kneading paddle. Place the bread pan in the Cuisinart™ Convection Bread Maker. Press Menu and select Artisan Dough. Press Start to mix, knead and rise. When cycle is completed remove dough from pan and transfer to a well-floured surface. Punch to deflate and let it rest 10 minutes before continuing.

Preheat oven to 425°F.

Divide dough into 2 equal pieces. Shape each piece into a round. With the dough cupped in your hands, roll, seamed edges down, on the counter until the underside is smooth. Place on prepared baking trays lined with parchment paper and cover with plastic wrap and let rest for 30 to 40 minutes, until the loaf has doubled in size.

When ready to bake, dust dough round with flour and cut a cross approximately 3 inches long in the top of the loaf, cutting about ¼-inch into the loaf. Bake in preheated oven for 25 to 30 minutes, until it is golden brown and sounds hollow when tapped. When finished, remove from pan and transfer to wire rack to cool. Bread slices best when allowed to cool.

*Nutritional information per serving (1 ounce):*

*Calories 83 (17% from fat) • carb. 14g • pro. 3g • fat 2g • sat. fat 0g • chol. 0mg • sod. 147mg • calc. 3mg • fiber 1g*

# Challah Loaf

Sweet Breads Cycle  
Delay Start Timer – No

<b>Ingredients</b>	<b>Large – 2 pounds</b>	<b>Medium – 1½ pounds</b>	<b>Small – 1 pound</b>
<b>Water</b>	<b>1 cup</b>	<b>¾ cup</b>	<b>½ cup + 2 tablespoons</b>
<b>Unsalted butter, ½-inch pieces at room temperature</b>	<b>½ cup + 2 tablespoons</b>	<b>½ cup</b>	<b>¼ cup</b>
<b>Eggs, large, at room temperature*</b>	<b>2</b>	<b>1</b>	<b>1</b>
<b>Salt</b>	<b>1¼ teaspoons</b>	<b>1 teaspoon</b>	<b>¾ teaspoon</b>
<b>Granulated sugar</b>	<b>3 tablespoons + 2 teaspoons</b>	<b>3 tablespoons</b>	<b>2 tablespoons + 1 teaspoon</b>
<b>Bread flour</b>	<b>3¾ cups</b>	<b>3 cups</b>	<b>2¼ cups</b>
<b>Yeast, active dry, instant or bread machine</b>	<b>2¼ teaspoons</b>	<b>2¼ teaspoons</b>	<b>2 teaspoons</b>

Place ingredients, in the order listed, in the bread pan fitted with the kneading paddle. Place the bread pan in the Cuisinart™ Convection Bread Maker. Press Menu and select Sweet Breads. Press Crust and select Medium (or to taste). Press Loaf and select dough size. Press Start to mix, knead, rise and bake. When cycle is completed, remove bread from machine and transfer to wire rack to cool. Bread slices best when allowed to cool.

\* Gently and safely warm cold eggs by placing whole eggs in a bowl and covering with moderately hot tap water for 10 minutes.

**To prepare using Rapid Sweet Breads cycle:** Select Rapid Sweet Breads, medium crust, loaf size.  
Use rapid rise yeast in place of standard yeast in recipe and add vital wheat gluten (optional – aids in rise).

<b>Ingredients</b>	<b>Large – 2 pounds</b>	<b>Medium – 1½ pounds</b>	<b>Small – 1 pound</b>
<b>Rapid rise yeast</b>	<b>3 teaspoons</b>	<b>2½ teaspoons</b>	<b>2 teaspoons</b>
<b>Vital wheat gluten (optional)</b>	<b>2 teaspoons</b>	<b>1½ teaspoons</b>	<b>1 teaspoon</b>

*Nutritional information per serving (1 ounce):*

*Calories 128 (29% from fat) • carb. 20g • pro. 3g • fat 4g • sat. fat 2g • chol. 27mg • sod. 202mg • calc. 7mg • fiber 1g*

# Panettone Loaf

Sweet Breads Cycle  
Delay Start Timer – No

<b>Ingredients</b>	<b>Large – 2 pounds</b>	<b>Medium – 1½ pounds</b>	<b>Small – 1 pound</b>
<b>Milk</b>	¾ cup	½ cup	½ cup
<b>Unsalted butter, ½-inch pieces at room temperature</b>	½ cup	¼ cup	2 tablespoons
<b>Eggs, large, at room temperature*</b>	2	2	1
<b>Orange zest</b>	3½ teaspoons	3 teaspoons	2 teaspoons
<b>Salt</b>	1 teaspoon	¾ teaspoon	½ teaspoon
<b>Granulated sugar</b>	½ cup	¼ cup	2 tablespoons
<b>Bread flour</b>	3 cups + 6 tablespoons	2¾ cups	2 cups
<b>Anise seed</b>	1¼ teaspoons	1 teaspoon	¾ teaspoon
<b>Ground nutmeg</b>	¾ teaspoon	½ teaspoon	¼ teaspoon
<b>Mixed fruit (both dried and candied citrus)</b>	1 cup	¾ cup	½ cup
<b>Pine nuts</b>	¾ cup	½ cup	¼ cup
<b>Yeast, active dry, instant or bread machine</b>	2¼ teaspoons	2¼ teaspoons	2 teaspoons

Place ingredients, in the order listed, in the bread pan fitted with the kneading paddle. Place the bread pan in the Cuisinart™ Convection Bread Maker. Press Menu and select Sweet Breads. Press Crust and select Medium (or to taste). Press Loaf and select dough size. Press Start to mix, knead, rise and bake. When cycle is completed, remove bread from machine and transfer to wire rack to cool. Bread slices best when allowed to cool.

\* Gently and safely warm cold eggs by placing whole eggs in a bowl and covering with moderately hot tap water for 10 minutes.

**To prepare using Rapid Sweet Breads cycle:** Select Rapid Sweet Breads, medium crust, loaf size.

Use rapid rise yeast in place of standard yeast in recipe and add vital wheat gluten (optional – aids in rise).

<b>Ingredients</b>	<b>Large – 2 pounds</b>	<b>Medium – 1½ pounds</b>	<b>Small – 1 pound</b>
<b>Rapid rise yeast</b>	3 teaspoons	2½ teaspoons	2 teaspoons
<b>Vital wheat gluten (optional)</b>	2 teaspoons	1½ teaspoons	1 teaspoon

*Nutritional information per serving (1 ounce):*

*Calories 115 (33% from fat) • carb. 16g • pro. 4g • fat 4g • sat. fat 2g • chol. 23mg • sod. 83mg • calc. 14mg • fiber 1g*  
Download from [www.somanuals.com](http://www.somanuals.com). All Manuals Search And Download.

# Rich Raisin Loaf

Sweet Breads Cycle  
Delay Start Timer – No

<b>Ingredients</b>	<b>Large – 2 pounds</b>	<b>Medium – 1½ pounds</b>	<b>Small – 1 pound</b>
<b>Milk</b>	¾ cup	½ cup	¼ cup
<b>Unsalted butter, ½-inch pieces at room temperature</b>	½ cup	¼ cup	2 tablespoons
<b>Eggs, large, at room temperature*</b>	2	2	1
<b>Salt</b>	1 teaspoon	¾ teaspoon	½ teaspoon
<b>Granulated sugar</b>	3 tablespoons + 2 teaspoons	3 tablespoons	2 tablespoons + 1 teaspoon
<b>Bread flour</b>	3¾ cups	3 cups	2¾ cups
<b>Raisins</b>	¾ cup	½ cup	¼ cup
<b>Yeast, active dry, instant or bread machine</b>	2¼ teaspoons	2¼ teaspoons	2 teaspoons

Place the milk, butter, eggs, salt, sugar, bread flour, and yeast, in the order listed, in the bread pan fitted with the kneading paddle. Place the bread pan in the Cuisinart™ Convection Bread Maker. Press Menu and select Sweet Breads. Press Crust and select Medium (or to taste). Press Loaf and select dough size. Press Start to mix, knead, rise and bake. When Mix-in's tone sounds, add raisins. If desired, when pause tone sounds, remove dough and paddle. Shape dough into a ball and replace in bread pan. Press Start to continue. When cycle is completed, remove bread from machine and transfer to wire rack to cool. Bread slices best when allowed to cool.

\* Gently and safely warm cold eggs by placing whole eggs in a bowl and covering with moderately hot tap water for 10 minutes.

**To prepare using Rapid Sweet Breads cycle:** Select Rapid Sweet Breads, medium crust, loaf size.

Use rapid rise yeast in place of standard yeast in recipe and add vital wheat gluten (optional – aids in rise).

<b>Ingredients</b>	<b>Large – 2 pounds</b>	<b>Medium – 1½ pounds</b>	<b>Small – 1 pound</b>
<b>Rapid rise yeast</b>	3 teaspoons	2½ teaspoons	2 teaspoons
<b>Vital wheat gluten (optional)</b>	2 teaspoons	1½ teaspoons	1 teaspoon

*Nutritional information per serving (1 ounce):*

*Calories 105 (24% from fat) • carb. 17g • pro. 3g • fat 3g • sat. fat 1g • chol. 23mg • sod. 82mg • calc. 13mg • fiber 1g*

# Stollen Loaf

Sweet Breads Cycle  
Delay Start Timer – No

<b>Ingredients</b>	<b>Large – 2 pounds</b>	<b>Medium – 1½ pounds</b>	<b>Small – 1 pound</b>
Milk, lowfat	1 cup	¾ cup	¾ cup
Unsalted butter, ½-inch pieces at room temperature	½ cup + 2 tablespoons	½ cup	¼ cup
Eggs, large, at room temperature*	2	2	1
Lemon zest	3 teaspoons	2 teaspoons	1½ teaspoons
Salt	1 teaspoon	¾ teaspoon	½ teaspoon
Granulated sugar	½ cup	¼ cup	2 tablespoons
Bread flour	3½ cups + 2 tablespoons	3 cups + 2 tablespoons	2¼ cups
Ground cinnamon	1¼ teaspoons	1 teaspoon	¾ teaspoon
Ground nutmeg	¾ teaspoon	½ teaspoon	¼ teaspoon
Yeast, active dry, instant or bread machine	2¼ teaspoons	2¼ teaspoons	2 teaspoons
Raisins	¾ cup	½ cup	¾ cup
Slivered almonds	¾ cup	½ cup	¾ cup

Place the milk, butter, eggs, zest, salt, sugar, bread flour, cinnamon, nutmeg, and yeast, in the order listed, in the bread pan fitted with the kneading paddle. Place the bread pan in the Cuisinart™ Convection Bread Maker. Press Menu and select Sweet Breads. Press Crust and select Medium (or to taste). Press Loaf and select dough size. Press Start to mix, knead, rise, and bake. When Mix-in's tone sounds, add raisins and slivered almonds. If desired, when Pause tone sounds, remove dough and paddle. Shape dough into a ball and replace in bread pan. Press Start to continue. When cycle is completed, remove bread from machine and transfer to wire rack to cool. Bread slices best when allowed to cool.

\* Gently and safely warm cold eggs by placing whole eggs in a bowl and covering with moderately hot tap water for 10 minutes.

**To prepare using Rapid Sweet Breads cycle:** Select Rapid Sweet Breads, medium crust, loaf size.

Use rapid rise yeast in place of standard yeast in recipe and add vital wheat gluten (optional – aids in rise).

<b>Ingredients</b>	<b>Large – 2 pounds</b>	<b>Medium – 1½ pounds</b>	<b>Small – 1 pound</b>
Rapid rise yeast	3 teaspoons	2½ teaspoons	2 teaspoons
Vital wheat gluten (optional)	2 teaspoons	1½ teaspoons	1 teaspoon

Nutritional information per serving (1 ounce):

Calories 144 (36% from Dairy) and 19% from Saturated Fats. All other ingredients. See 25 Aug 2016. 34g • calc. 30mg • fiber 1g

# Sally Lunn Bread

Sweet Breads Cycle  
Delay Start Timer – No

<b>Ingredients</b>	<b>Large – 2 pounds</b>	<b>Medium – 1½ pounds</b>	<b>Small – 1 pound</b>
Evaporated lowfat milk, 80°–90°F	½ cup	½ cup	¼ cup
Eggs, large, at room temperature*	4	3	2
Unsalted butter, ½-inch pieces at room temperature	6 tablespoons	4½ tablespoons	3 tablespoons
Granulated sugar	¼ cup	3 tablespoons	2 tablespoons
Salt	1 teaspoon	¾ teaspoon	½ teaspoon
Bread flour	4 cups	3 cups	2 cups
Nonfat dry milk	¼ cup	3 tablespoons	2 tablespoons
Yeast, active dry, instant or bread machine	2 teaspoons	1½ teaspoons	1 teaspoon

Place all ingredients, in the order listed, in the bread pan fitted with the kneading paddle. Place in the Cuisinart™ Convection Bread Maker. Press Menu and select Sweet Breads. Press Crust and select Medium (or to taste). Press Loaf and select dough size. Press Start to mix, knead, rise and bake. If desired, when pause tone sounds, remove dough and paddle. Shape dough into a ball and replace in bread pan. Press Start to continue. When cycle is completed, remove bread from machine and transfer to wire rack to cool. Bread slices best when allowed to cool.

\* Gently and safely warm cold eggs by placing whole eggs in a bowl and covering with moderately hot tap water for 10 minutes.

**To prepare using Rapid Sweet Breads cycle:** Select Rapid Sweet Breads, medium crust, loaf size.

Use rapid rise yeast in place of standard yeast in recipe and add vital wheat gluten (optional – aids in rise).

<b>Ingredients</b>	<b>Large – 2 pounds</b>	<b>Medium – 1½ pounds</b>	<b>Small – 1 pound</b>
Rapid rise yeast	3 teaspoons	2½ teaspoons	2 teaspoons
Vital wheat gluten (optional)	2 teaspoons	1½ teaspoons	1 teaspoon

*Nutritional information per serving (1 ounce):*

*Calories 101 (26% from fat) • carb. 15g • pro. 4g • fat 3g • sat. fat 2g • chol. 32mg • sod. 91mg • calc. 27mg • fiber 0g*



# “Apple Pie” Bread

Sweet Breads Cycle  
Delay Start Timer – No

<b>Ingredients</b>	<b>Large – 2 pounds</b>	<b>Medium – 1½ pounds</b>	<b>Small – 1 pound</b>
Milk, lowfat, 80°–90°F	1 cup	¾ cup + 2 tablespoons	½ cup + 1 tablespoon
Eggs, large, at room temperature*	3	2	1
Unsalted butter, ½-inch pieces at room temperature	3 tablespoons	2 tablespoons + 1 teaspoon	1½ tablespoons
Brown sugar, packed	¼ cup	3 tablespoons	2 tablespoons
Salt	1½ teaspoons	1½ teaspoons	¾ teaspoon
Bread flour	4¼ cups	3¾ cups	2¾ cups
Yeast, active dry, instant or bread machine	2¼ teaspoons	1¾ teaspoons	1½ teaspoons
Dried apples, packed	½ cup	½ cup	¼ cup
Walnuts, chopped	½ cup	¼ cup	3 tablespoons
Raisins, packed	½ cup	¼ cup	3 tablespoons

Place the milk, eggs, butter, brown sugar, salt, bread flour, and yeast, in the order listed, in the bread pan fitted with the kneading paddle. Place in bread pan in the Cuisinart™ Convection Bread Maker. Press Menu and select Sweet Breads. Press Crust and select Medium (or to taste). Press Loaf and select dough size. Press Start to mix, knead, and rise. When Mix-in's tone sounds, add dried apples, walnuts and raisins. When pause signal sounds, remove dough and kneading paddle if desired, reshape dough and replace in bread pan. Press Start to continue. When cycle is completed, remove bread from machine and transfer to wire rack to cool. Bread slices best when allowed to cool.

\* Gently and safely warm cold eggs by placing whole eggs in a bowl and covering with moderately hot tap water for 10 minutes.

**To prepare using Rapid Sweet Breads cycle:** Select Rapid Sweet Breads, medium crust, loaf size.

Use rapid rise yeast in place of standard yeast in recipe and add vital wheat gluten (optional – aids in rise).

<b>Ingredients</b>	<b>Large – 2 pounds</b>	<b>Medium – 1½ pounds</b>	<b>Small – 1 pound</b>
Rapid rise yeast	3 teaspoons	2½ teaspoons	2 teaspoons
Vital wheat gluten (optional)	2 teaspoons	1½ teaspoons	1 teaspoon

*Nutritional information per serving (one ounce):*

*Calories 105 (26% from fat) • carb. 16g • pro. 3g • fat 3g • sat. fat 1g • chol. 21mg • sod. 122mg • calc. 19mg • fiber 1g*

# “Chocolate Chip Cookie” Bread

Sweet Breads Cycle  
Delay Start Timer – No

<b>Ingredients</b>	<b>Large – 2 pounds</b>	<b>Medium – 1½ pounds</b>	<b>Small – 1 pound</b>
Milk, lowfat, 80°–90°F	¾ cup	9 tablespoons	6 tablespoons
Eggs, large, at room temperature*	3	2	1
Vanilla extract	1½ teaspoons	1½ teaspoons	¾ teaspoon
Unsalted butter, ½-inch pieces at room temperature	2 tablespoons	4½ teaspoons	1 tablespoon
Brown sugar, packed	¼ cup	3 tablespoons	2 tablespoons
Salt	1 teaspoon	¾ teaspoon	½ teaspoon
Bread flour	3¼ cups	2¾ cups	1¾ cups
Yeast, active dry, instant or bread machine	2¼ teaspoons	1¾ teaspoons	1½ teaspoons
Graham cracker crumbs	¾ cup	½ cup	½ cup
Nonfat dry milk	3 tablespoons	6½ teaspoons	1½ tablespoons
Semisweet chocolate morsels	¾ cup	½ cup	½ cup
Chopped walnuts or pecans	½ cup	½ cup	¼ cup

Place the milk, eggs, vanilla, butter, brown sugar, salt, bread flour, graham cracker crumbs and yeast, in the order listed, in the bread pan fitted with the kneading paddle. Place in bread pan in the Cuisinart™ Convection Bread Maker. Press Menu and select Sweet Breads. Press Crust and select Medium (or to taste). Press Loaf to select dough size. Press Start to mix, knead, and rise. When Mix-in's tone sounds, add chocolate morsels and nuts. When pause signal sounds, remove dough and kneading paddle if desired, reshape dough and replace in bread pan. Press Start to continue. When cycle is completed, remove bread from machine and transfer to wire rack to cool. Bread slices best when allowed to cool.

\* Gently and safely warm cold eggs by placing whole eggs in a bowl and covering with moderately hot tap water for 10 minutes.

**To prepare using Rapid Sweet Breads cycle:** Select Rapid Sweet Breads, medium crust, loaf size.

Use rapid rise yeast in place of standard yeast in recipe and add vital wheat gluten (optional – aids in rise).

<b>Ingredients</b>	<b>Large – 2 pounds</b>	<b>Medium – 1½ pounds</b>	<b>Small – 1 pound</b>
Rapid rise yeast	3 teaspoons	2½ teaspoons	2 teaspoons
Vital wheat gluten (optional)	2 teaspoons	1½ teaspoons	1 teaspoon

Nutritional information per serving (1 ounce):

Calories 88 (29% from fat) • carb. 13g • pro. 3g • fat 3g • sat. fat 1g • chol. 22mg • sod. 26mg • calc. 25mg • fiber 0g

Download from [www.Somaterials.com](http://www.Somaterials.com). All Manuals Search And Download.

# Jams, Sauces, Chutneys

Your Cuisinart™ Convection Bread Maker makes delicious jams, preserves and chutneys. This section includes some of our test kitchen's favorite recipes – or use your own favorites – to accompany the wonderful breads you'll bake with the bread maker.

---

## Cranberry Sauce

Makes 2 cups

- 3 cups fresh or frozen cranberries, rinsed (remove and discard any stems)**
- 1 cup granulated sugar**
- ½ cup cranberry juice**
- 1½ teaspoons pure vanilla extract**
- 1 teaspoon grated orange zest**

Place the cranberries, sugar, juice, vanilla, and zest in a medium bowl. Stir to combine. Transfer to the bread pan fitted with the kneading paddle. Place the bread pan in the Cuisinart™ Convection Bread Maker. Press Menu and select Jam. Press Start. Scrape the sides of the pan when tone beeps sound at 5 and 10 minutes into the cycle. Transfer cranberry sauce to clean jars. Let cool, then cover and refrigerate. Keeps refrigerated 4 to 6 weeks.

*Nutritional information per serving (2 tablespoons):*

*Calories 28 (1% from fat) • carb. 7g • pro. 0g • fat 0g • sat. fat 0g • chol. 0mg • sod. 0mg • calc. 1 mg • fiber 0g*

## “Berried” Applesauce

Makes about 3 cups chunky-style applesauce

- 2 pounds apples, peeled, cored, quartered and thinly sliced (¼-inch)**
- 1 cup (5 ounces) quartered strawberries**
- ¾ cup blueberries**
- ½ cup apple cider or unsweetened apple juice**
- ½ cup granulated sugar or Splenda®**
- 2 tablespoons fresh lemon juice**

Place the apples, strawberries, blueberries, cider, Splenda®, and lemon juice in a medium bowl. Stir to combine. Transfer to the bread pan fitted with the kneading paddle. Place the bread pan in the Cuisinart™ Convection Bread Maker. Press Menu and select Jam. Press Start. Scrape the sides of the pan when tone beeps at 5 and 10 minutes into the cycle.

Serve warm or transfer “Berried” Applesauce to a resealable container. Let cool, then cover and refrigerate. Keeps refrigerated about 1 week.

*Nutritional information per serving (¼ cup made with granulated sugar):*

*Calories 89 (3% from fat) • carb. 23g • pro. 0g • fat 0g • sat. fat 0g • chol. 0mg • sod. 1mg • calc. 6mg • fiber 2g*

## Tomato Chutney

Makes about 4 cups

- 1 can (14–15 ounce) diced tomatoes, with juices
- 6 ounces finely chopped (¼-inch) onion (about 1 cup)
- 5 ounces finely chopped (¼-inch) green pepper (1 cup)
- 1 cup packed light brown sugar
- ½ cup diced (¼-inch) apple
- ½ cup golden raisins
- ½ cup cider vinegar
- 3 tablespoons powdered pectin
- 2 tablespoons tomato paste
- 1 teaspoon kosher salt
- 1 teaspoon freshly ground black pepper
- 1 teaspoon Tabasco® or other hot sauce
- ½ teaspoon dry mustard
- ¼ teaspoon ground allspice

Place all ingredients in a medium bowl and stir to blend. Transfer to the bread pan fitted with the kneading paddle. Place the bread pan in the Cuisinart™ Convection Bread Maker. Press Menu and select Jam. Press Start. Scrape the sides of the pan when tone beeps at 5 and 10 minutes into the cycle.

When complete, spoon into clean dry jars. Let cool, then cover. Store in refrigerator for up to 6 weeks.

*Nutritional information per serving (1 tablespoon):*

*Calories 46 (1% from fat) • carb. 12g • pro. 0g • fat 0g • sat. fat 0g • chol. 0mg  
• sod. 96mg • calc. 10mg • fiber 0g*

## Tart Pink Grapefruit Marmalade

Makes 3 cups

- 2½ pounds small to medium pink grapefruit (about 4)
- 1½ cups granulated sugar \*
- ¼ cup orgeat syrup\*\*
- 1 box (1.75 ounces) powdered pectin

Peel grapefruit using a sharp knife. Slice the bitter white pith from the peel, leaving just a thin layer on the peel. Discard bitter white pith. Cut the peel into thin (¼-inch thick) slices and place in a medium bowl. Cut the grapefruit into sections, removing the membrane and seeds. Add the sections and any accumulated juices to the bowl. Stir in sugar. Cover and refrigerate for 24 hours – this is to tenderize the grapefruit peel.

Stir the orgeat and pectin into the macerated grapefruit peel and sections. Transfer to the bread pan fitted with the kneading paddle. Place the bread pan in the Cuisinart™ Convection Bread Maker. Press Menu and select Jam. Press Start. Scrape the sides of the pan when tone beeps at 5 and 10 minutes into the cycle.

Transfer marmalade to clean jars. Let cool, then cover and refrigerate. Keeps refrigerated for 4 to 6 weeks.

\*This makes a tart, English-style marmalade. For a sweeter marmalade, increase the sugar to 2 cups and the orgeat to ½ cup.

\*\*Orgeat syrup is an almond-flavored syrup most often used in cocktails such as the MaiTai or Scorpion. It can be found in most well-stocked grocery stores with the drink mixers.

*Nutritional information per serving (1 tablespoon):*

*Calories 32 (1% from fat) • carb. 8g • pro. 0g • fat 0g • sat. fat 0g • chol. 0mg  
• sod. 3mg • calc. 3mg • fiber 0g*

## Peach, Mango, Papaya and Apricot Jam

Makes about 3 cups

- 1 cup (8 ounces) diced (½-inch) peaches**
- 1 cup (6 ounces) diced (½-inch) mango**
- 1 cup (6 ounces) diced (½-inch) papaya**
- ½ cup (4 ounces) dried apricots, cut in quarters**
- 1¼ cups granulated sugar**
- 3 tablespoons fresh lemon juice**
- ¼ cup powdered pectin**

Place all ingredients in a medium bowl and stir. Transfer to the bread pan fitted with the kneading paddle. Place the bread pan in the Cuisinart™ Convection Bread Maker. Press Menu and select Jam. Press Start. Scrape the sides of the pan when tone beeps at 5 and 10 minutes into the cycle.

Transfer jam to clean jars. Let cool, then cover and refrigerate. Keeps refrigerated 4 to 6 weeks.

*Nutritional information per serving (1 tablespoon):*

*Calories 36 (1% from fat) • carb. 9g • pro. 0g • fat 0g • sat. fat 0g • chol. 3mg  
• sod. 3mg • calc. 3mg • fiber 0g*

## Strawberry Rhubarb Jam

Makes about 3 cups

- 1 pound fresh strawberries, stemmed and quartered or halved**
- 12 ounces fresh rhubarb, cut in ½-inch slices**
- ¾ cup granulated sugar**
- ½ cup packed brown sugar**
- ¼ cup powdered pectin**
- ½ teaspoon ground cinnamon**

Place half the strawberries in a bowl with ¼ cup of the granulated sugar. Use a potato masher or fork to mash roughly – it should be slightly chunky with some liquid. Add remaining ingredients and stir to combine. Transfer the bread pan fitted with the kneading paddle. Place the bread pan in the Cuisinart™ Convection Bread Maker. Press Menu and select Jam. Press Start. Scrape the sides of the pan when tone beeps at 5 and 10 minutes into the cycle.

Transfer jam to clean jars. Let cool, then cover and refrigerate. Keeps refrigerated 4 to 6 weeks.

*Nutritional information per serving (1 tablespoon):*

*Calories 24 (2% from fat) • carb. 6g • pro. 0g • fat 0g • sat. fat 0g • chol. 0mg  
• sod. 3mg • calc. 9mg • fiber 0g*

## Pear and Ginger Preserves

Makes 2 cups

- 1** pound thinly sliced pears (weigh after peeling and coring)
- 1** cup granulated sugar
- ¼** cup powdered pectin
- 3** tablespoons fresh lemon juice
- 2-3** tablespoons candied ginger bits (to taste)
- 1** teaspoon grated fresh lemon zest
- ¼** teaspoon powdered ginger

Place the pears, sugar, pectin, lemon juice, candied ginger, zest, and powdered ginger in a medium bowl. Stir to combine. Transfer to the bread pan fitted with the kneading paddle. Place the bread pan in the Cuisinart™ Convection Bread Maker. Press Menu and select Jam. Press Start. Scrape the sides of the pan when tone beeps at 5 and 10 minutes into the cycle.

Transfer Pear and Ginger Preserves to clean jars. Let cool, then cover and refrigerate. Keeps refrigerated 4 to 6 weeks.

*Nutritional information per serving (1 tablespoon):*

*Calories 43 (1% from fat) • carb. 11g • pro. 0g • fat 0g • sat. fat 0g • chol. 0mg  
• sod. 4mg • calc. 5mg • fiber 0g*

## Blueberry Lime Jam

Makes 3 cups

- 6** cups fresh blueberries
- 1½** cups granulated sugar
- 1** package (1.75 ounce) powdered pectin
- ¼** cup fresh lime juice
- 1** teaspoon grated fresh lime zest

Place the blueberries, sugar, pectin, lime juice, and zest in a medium bowl. Stir to combine. Transfer to the bread pan fitted with the kneading paddle. Place the bread pan in the Cuisinart™ Convection Bread Maker. Press Menu and select Jam. Press Start. Scrape the sides of the pan when tone beeps at 5 and 10 minutes into the cycle.

Transfer Blueberry Lime Jam to clean jars. Let cool, then cover and refrigerate. Keeps refrigerated 4 to 6 weeks.

*Nutritional information per serving (1 tablespoon):*

*Calories 35 (2% from fat) • carb. 9g • pro. 0g • fat 0g • sat. fat 0g • chol. 0mg  
• sod. 3mg • calc. 1mg • fiber 1g*

## Plum Cassis Jam

Makes about 3 cups

- 2 pounds plums, pitted and cut into ¼-inch slices**
- ¾ cup granulated sugar**
- ½ cup crème de cassis liqueur**
- ¼ cup fresh lemon juice**
- 1 package (1.75 ounce) powdered pectin**
- 1 teaspoon cinnamon**

Place the sliced plums, sugar, cassis, lemon juice, pectin, and cinnamon in a medium bowl. Stir to combine. Transfer to the bread pan fitted with the kneading paddle. Place the bread pan in the Cuisinart™ Convection Bread Maker. Press Menu and select Jam. Press Start. Scrape the sides of the pan when tone beeps at 5 and 10 minutes into the cycle.

Transfer Plum Cassis Jam to clean jars. Let cool, then cover and refrigerate. Keeps refrigerated 4 to 6 weeks.

*Nutritional information per serving (1 tablespoon):*

*Calories 33 (3% from fat) • carb. 8g • pro. 0g • fat 0g • sat. fat 0g • chol. 0mg  
• sod. 2mg • calc. 2mg • fiber 0g*

## Cherry Bounce Jam

Makes about 3 cups

- 1½ pounds pitted sweet dark cherries (thaw if using frozen)**
- ¾ cup granulated sugar**
- 3 tablespoons Kirschwasser**
- 3 tablespoons fresh lemon juice**
- 1 package (1.75 ounce) powdered pectin**
- ½ teaspoon ground allspice**

Place the cherries, sugar, Kirschwasser, lemon juice, pectin, and allspice in a medium bowl. Stir to combine. Transfer to the bread pan fitted with the kneading paddle. Place the bread pan in the Cuisinart™ Convection Bread Maker. Press Menu and select Jam. Press Start. Scrape the sides of the pan when tone beeps at 5 and 10 minutes into the cycle.

Transfer Cherry Bounce Jam to clean jars. Let cool, then cover and refrigerate. Keeps refrigerated 4 to 6 weeks.

*Nutritional information per serving (1 tablespoon):*

*Calories 27 (1% from fat) • carb. 6g • pro. 0g • fat 0g • sat. fat 0g • chol. 0mg  
• sod. 3mg • calc. 3mg • fiber 0g*

## Tips and Hints for Last-Minute Loaves

When making Last-Minute Loaves it is important to remember a few things:

These breads are best consumed within 2 hours after preparing.

Allow the bread to cool before cutting to allow the structure to develop properly. Or allow to remain in the Bread Maker for the 60-Minute Keep Warm cycle before serving.

When preparing these loaves, bring all solid ingredients to room temperature and liquids to 100°F.

It is necessary to use rapid rise yeast when making Last-Minute Loaves – do not substitute instant or bread machine yeast for the rapid rise yeast.

The texture and rise of the bread is greatly improved by adding vital wheat gluten to the mixture – in a pinch it can be left out, but keep it on hand for Last-Minute Loaves.

For a more classic/traditional bread, any of the following recipes may be made on the White cycle – use instant or bread machine yeast, reduce the amount of yeast used to 2 teaspoons, and omit the vital wheat gluten. To prepare using the Rapid White cycle, use 2 teaspoons rapid rise yeast, and add 1 to 2 teaspoons vital wheat gluten to enhance the rising.



## Last-Minute White Loaf

<b><i>Ingredients</i></b>	<b><i>Large – 2 pounds</i></b>	<b><i>Medium – 1½ pounds</i></b>
<b>Water, 100°F</b>	<b>1½ cups</b>	<b>1½ cups</b>
<b>Vegetable oil or melted unsalted butter</b>	<b>1 tablespoon</b>	<b>2¼ teaspoons</b>
<b>Salt</b>	<b>2 teaspoons</b>	<b>1½ teaspoons</b>
<b>Sugar</b>	<b>2 teaspoons</b>	<b>1½ teaspoons</b>
<b>Bread flour</b>	<b>4 cups</b>	<b>3 cups</b>
<b>Vital wheat gluten</b>	<b>2 teaspoons</b>	<b>1½ teaspoons</b>
<b>Rapid rise yeast</b>	<b>4 teaspoons</b>	<b>3 teaspoons</b>

Place all ingredients, in order listed, in bread pan fitted with kneading paddle. Place the bread pan in the Cuisinart™ Convection Bread Maker. Press Menu and select Last Minute Loaf. Press Start to mix, knead, rise and bake. Remove from bread pan when done and allow to cool for 1 hour or allow to remain in bread maker for 60-Minute Keep Warm Cycle before serving.

*Nutritional information per serving (1 ounce):*

*Calories 70 (9% from fat) • carb. 13g • pro. 3g • fat 1g • sat. fat 0g • chol. 0mg • sod. 148mg • calc. 3mg • fiber 0g*

## Last-Minute “Pesto” Loaf

<b><i>Ingredients</i></b>	<b><i>Large – 2 pounds</i></b>	<b><i>Medium – 1½ pounds</i></b>
<b>Water, 100°F</b>	<b>1½ cups</b>	<b>1½ cups</b>
<b>Extra virgin olive oil</b>	<b>2 tablespoons</b>	<b>2¼ teaspoons</b>
<b>Granulated sugar</b>	<b>2 teaspoons</b>	<b>1½ teaspoons</b>
<b>Salt</b>	<b>1½ teaspoons</b>	<b>1½ teaspoons</b>
<b>Bread flour</b>	<b>4¾ cups</b>	<b>3 cups + 1½ tablespoons</b>
<b>Vital wheat gluten</b>	<b>4 teaspoons</b>	<b>3 teaspoons</b>
<b>Freshly grated Parmesan or Grana Padano® cheese</b>	<b>½ cup</b>	<b>½ cup</b>
<b>Dried basil</b>	<b>1 tablespoon</b>	<b>2¼ teaspoons</b>
<b>Walnuts, toasted, chopped</b>	<b>½ cup</b>	<b>½ cup</b>
<b>Rapid rise yeast</b>	<b>4 teaspoons</b>	<b>3 teaspoons</b>

Place all ingredients, in order listed, in bread pan fitted with kneading paddle. Place the bread pan in the Cuisinart™ Convection Bread Maker. Press Menu and select Last Minute Loaf. Press Start to mix, knead, rise and bake. Remove from bread pan when done and allow to cool for 1 hour or allow to remain in bread maker for 60-Minute Keep Warm Cycle before serving.

*Nutritional information per serving (1 ounce):*

*Calories 96 (25% from fat ) • carb. 14g • pro. 3g • fat 3g • sat. fat 1g • chol. 1mg • sod. 129mg • calc. 25mg • fiber 1g*

# Salsa and Cheese Last-Minute Loaf

Makes 1 loaf, about 2 pounds

<b><i>Ingredients</i></b>	<b><i>Large – 2 pounds</i></b>	<b><i>Medium – 1½ pounds</i></b>
<b>Prepared (purchased – medium heat) salsa, warmed to 100°F</b>	<b>1¾ cups</b>	<b>1¼ cups + 1 tablespoon</b>
<b>Flavorful olive oil</b>	<b>3 tablespoons</b>	<b>2 tablespoons + 1 teaspoon</b>
<b>Grated sharp or extra-sharp Cheddar cheese</b>	<b>½ cup</b>	<b>¼ cup</b>
<b>Bread flour</b>	<b>4 cups</b>	<b>3 cups</b>
<b>Vital wheat gluten</b>	<b>4 teaspoons</b>	<b>3 teaspoons</b>
<b>Rapid rise yeast</b>	<b>4 teaspoons</b>	<b>3 teaspoons</b>

Place all ingredients, in order listed, in bread pan fitted with kneading paddle. Place the bread pan in the Cuisinart™ Convection Bread Maker. Press Menu and select Last Minute Loaf. Press Start to mix, knead, rise and bake. Remove from bread pan when done and allow to cool for 1 hour or allow to remain in bread maker for 60-Minute Keep Warm Cycle before serving.

*Nutritional information per serving (1 ounce):*

*Calories 93 (21% from fat) • carb. 14g • pro. 4g • fat 2g • sat. fat 0g • chol. 2mg • sod. 118mg • calc. 28mg • fiber 1g*

## Last-Minute Corn Loaf

<b><i>Ingredients</i></b>	<b><i>Large – 2 pounds</i></b>	<b><i>Medium – 1½ pounds</i></b>
<b>Canned creamed corn</b>	<b>1¼ cups</b>	<b>¾ cup</b>
<b>Lowfat milk</b>	<b>½ cup</b>	<b>¼ cup</b>
<b>Unsalted butter, ½-inch pieces at room temperature</b>	<b>2 tablespoons</b>	<b>4½ teaspoons</b>
<b>Granulated sugar</b>	<b>2 teaspoons</b>	<b>1½ teaspoons</b>
<b>Salt</b>	<b>1 teaspoon</b>	<b>¾ teaspoon</b>
<b>Bread flour</b>	<b>3½ cups</b>	<b>2¾ cups</b>
<b>Yellow cornmeal</b>	<b>¾ cup</b>	<b>½ cup + 1 tablespoon</b>
<b>Vital wheat gluten</b>	<b>4 teaspoons</b>	<b>3 teaspoons</b>
<b>Rapid rise yeast</b>	<b>4 teaspoons</b>	<b>3 teaspoons</b>

Combine corn, milk and butter and warm to 100°F. Place all ingredients, in order listed, in bread pan fitted with kneading paddle. Place the bread pan in the Cuisinart™ Convection Bread Maker. Press Menu and select Last Minute Loaf. Press Start to mix, knead, rise and bake. Remove from bread pan when done and allow to cool for 1 hour or allow to remain in bread maker for 60-Minute Keep Warm Cycle before serving.

*Nutritional information per serving (1 ounce):*

*Calories 83 (13% from fat) • carb. 16g • pro. 2g • fat 1g • sat. fat 1g • chol. 2mg • sod. 118mg • calc. 10mg • fiber 1g*

## Last-Minute Cinnamon Raisin Yogurt Bread

<b><i>Ingredients</i></b>	<b><i>Large – 2 pounds</i></b>	<b><i>Medium – 1½ pounds</i></b>
<b>Fat-free plain yogurt</b>	<b>¾ cup</b>	<b>½ cup + 1 tablespoon</b>
<b>Lowfat milk</b>	<b>¾ cup</b>	<b>½ cup + 1 tablespoon</b>
<b>Unsalted butter, ½-inch pieces at room temperature</b>	<b>2 tablespoons</b>	<b>4½ teaspoons</b>
<b>Brown sugar, packed</b>	<b>2 tablespoons</b>	<b>4½ teaspoons</b>
<b>Salt</b>	<b>1½ teaspoons</b>	<b>1½ teaspoons</b>
<b>Cinnamon</b>	<b>1 teaspoon</b>	<b>¾ teaspoon</b>
<b>Bread flour</b>	<b>4 cups</b>	<b>3 cups</b>
<b>Vital wheat gluten</b>	<b>4 teaspoons</b>	<b>3 teaspoons</b>
<b>Rapid rise yeast</b>	<b>4 teaspoons</b>	<b>3 teaspoons</b>
<b>Raisins, not packed</b>	<b>½ cup</b>	<b>½ cup</b>

Place all ingredients, in order listed, in bread pan fitted with kneading paddle. Place the bread pan in the Cuisinart™ Convection Bread Maker. Press Menu and select Last Minute Loaf. Press Start to mix, knead, rise and bake. Remove from bread pan when done and allow to cool for 1 hour or allow to remain in bread maker for 60-Minute Keep Warm Cycle before serving.

*Nutritional information per serving (1 ounce)*

*Calories 85 (12% from fat) • carb. 16g • pro. 3g • fat 1g • sat. fat 1g • chol. 2mg • sod. 116mg • calc. 20mg • fiber 1g*

Notes: \_\_\_\_\_  
\_\_\_\_\_  
\_\_\_\_\_  
\_\_\_\_\_  
\_\_\_\_\_  
\_\_\_\_\_  
\_\_\_\_\_  
\_\_\_\_\_  
\_\_\_\_\_  
\_\_\_\_\_  
\_\_\_\_\_  
\_\_\_\_\_  
\_\_\_\_\_  
\_\_\_\_\_  
\_\_\_\_\_  
\_\_\_\_\_  
\_\_\_\_\_  
\_\_\_\_\_  
\_\_\_\_\_  
\_\_\_\_\_  
\_\_\_\_\_  
\_\_\_\_\_  
\_\_\_\_\_  
\_\_\_\_\_  
\_\_\_\_\_  
\_\_\_\_\_  
\_\_\_\_\_  
\_\_\_\_\_  
\_\_\_\_\_  
\_\_\_\_\_  
\_\_\_\_\_  
\_\_\_\_\_  
\_\_\_\_\_  
\_\_\_\_\_  
\_\_\_\_\_  
\_\_\_\_\_  
\_\_\_\_\_



# Cuisinart™

## INSTRUCTION BOOKLET

Recipe  
Booklet  
Reverse Side



**Cuisinart™ Convection Bread Maker**

**CBK-200**

For your safety and continued enjoyment of this product, always read the instruction book carefully before using.

G IB-5859A







---

# IMPORTANT SAFEGUARDS

When using electrical appliances, basic safety precautions should always be followed including the following:

- 1. READ ALL INSTRUCTIONS, PRODUCT LABELS AND WARNINGS BEFORE USING THIS BREAD MAKER.**
2. Do not touch hot surfaces; carry the unit by handles. Always use oven mitts when handling hot material, and allow metal parts to cool before cleaning. Allow the bread maker to cool thoroughly before putting in or taking off parts.
3. When unit is not in use and before cleaning, unplug the bread maker from wall outlet. Let the bread maker cool down thoroughly before assembling or disassembling it.
4. To protect against risk of electrical shock, do not immerse the appliance or plugs in water or other liquids.
5. Close supervision is always necessary when this or any appliance is used near children or incapacitated persons.
6. Do not allow anything to rest on the power cord. Do not plug in cord where people may walk or trip on it. Unplug this bread maker from the wall outlet before you go out for a trip or long excursion.
7. Do not operate this or any appliance with a frayed or damaged cord, or plug, or after the appliance malfunctions or is dropped or has been damaged in any manner. Take appliance to the nearest authorized service facility for examination, repair or electrical or mechanical adjustment.
8. Do not let the cord dangle over the edge of a table or counter or touch hot surfaces. Do not place on an unsteady or cloth-covered surface.
9. Avoid contact with moving parts.
10. Do not use attachments not recommended by the manufacturer. They may cause fire, electric shock or injury.
11. Do not use outdoors or for commercial purposes.
12. Do not place the appliance near a hot gas or electric burner, or in a heated oven.
13. Keep power cord away from the hot surface of this bread maker. Do not put any flammable object on the hot surface of this bread maker.
14. Place this bread maker a minimum of 2 inches away from wall or any other object.
15. Do not use this bread maker for other than its intended use.
16. When plugging or unplugging this bread maker, be sure not to touch the plug blades with your fingers.
17. To unplug, press and hold the Stop/Pause button for 1–3 seconds, grip plug and pull from wall outlet. Never pull on the cord.
18. Use of extension cords: A short power supply cord has been provided to reduce the risk of injury resulting from becoming entangled in or tripping over a longer cord. Extension cords are available from hardware stores and may be used with care. The cord should be arranged so that it will not drape over the counter or tabletop where it can be pulled by children or tripped over accidentally. If the appliance is of the grounded type, the extension cord should be grounding-type 3-wire cord.
19. Electric power: If electric circuit is overloaded with other appliances, your bread maker may not operate properly. This bread maker should be operated on a separate electrical circuit from other operating appliances.

**THIS UNIT IS INTENDED FOR  
HOUSEHOLD USE ONLY**

**READ AND SAVE THESE  
INSTRUCTIONS**

## SPECIAL CORD SET INSTRUCTIONS

### NOTICE

This appliance has a polarized plug (one blade is wider than the other). To reduce the risk of electric shock, this plug will fit in a polarized outlet only one way. If the plug does not fit fully in the outlet, reverse the plug. If it still does not fit, contact a qualified electrician. Do not modify the plug in any way.

### CONTENTS

Important Safeguards	1
Introduction	2
Parts and Features	2
Before First Use	3
Control Panel	3
Operating Instructions	3
Power Failure Backup	5
Program Options	6
Types of Bread	8
Cycles of Breadmaking	9
Timetable	10–13
Measuring Ingredients	13
Loading Ingredients into the Bread Pan	13
Measurement/Conversion Chart	13
Cleaning and Care	14
Tips and Hints	14
Troubleshooting	16
Bread Maker Pantry	17
Warranty	19

### INTRODUCTION

Get ready to enjoy warm, fresh, homemade bread whenever you want it! Your new Cuisinart™ Convection Bread Maker makes it easy, and even lets you program your baking for some breads up to 12 hours in advance. Decide which of our fabulous recipes you want to try, or use a family favorite.

Then just add ingredients and select a menu option, crust color and loaf size. We'll do the rest! We've included recipes for our Low-Carb and Gluten-Free menu options, as well as a variety of other breads, doughs and jams.

### PARTS AND FEATURES

- Removable lid:** brushed stainless steel with polished chrome rim
- Viewing window:** Glass viewing window
- Side handles:** Elegant, chrome side handles
- Control Panel:** Easy push button controls; 16 menu options, 3 crust colors, and 3 loaf sizes for over 100 choices
- LCD display:** Indicates program selections and baking cycles
- Removable bread pan with handle:** Horizontal loaf, nonstick
- Kneading paddle:** Removable, nonstick paddle
- Baking chamber**
- Heating element** (not shown)
- Power cord** (not shown)
- Measuring Spoon**
- Measuring Cup**

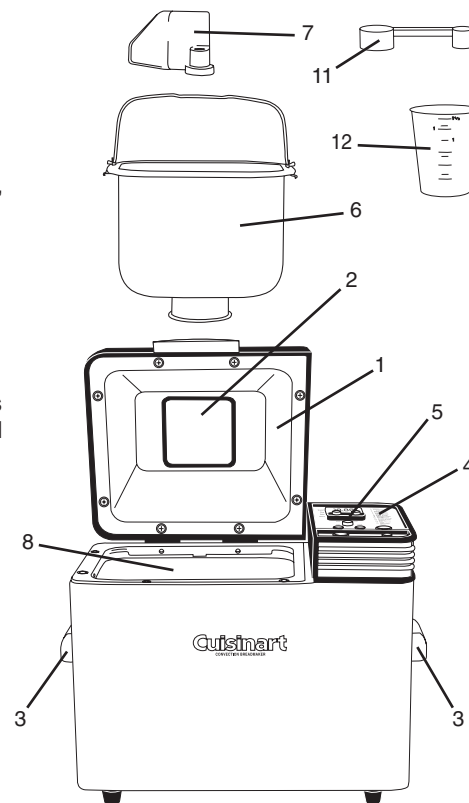

## BEFORE FIRST USE

Remove all packaging and any promotional labels or stickers from your bread maker. Be sure that all parts (page 2) of your new bread maker have been unpacked before discarding any packaging materials. You may want to keep the box and packing materials for use at a later date.

Before using your Cuisinart™ Convection Bread Maker for the first time, remove all protective paper and wrapping. Wipe housing with a damp cloth to remove any dust from the warehouse or shipping. Wash inside of lid with sponge or damp cloth.

## CONTROL PANEL

**Display Window** – Indicates your menu selection, current baking cycle, loaf size, crust color and baking time.

**Delay Start Timer** – The Cuisinart™ Convection Bread Maker allows you to program baking for a later time. Just set the Delay Start Timer for a finish-time up to 12 hours later.

**Mix-ins** – This audible signal will alert user when to add extra ingredients, such as fruits and nuts, during the second kneading cycle.

The red LED indicator will be on when the Mix-ins feature is activated; off when it's deactivated. Press the button once to deactivate the Mix-ins feature. The Mix-ins feature automatically defaults to on except for Low Carb, Quick Breads, Gluten Free and Last Minute Loaf.

**Please note:** There are no Mix-ins signals for Low Carb, Quick Bread, Gluten Free or Last Minute Loaf program options. Mix-ins must be added at the very beginning of the cycle with other basic ingredients.

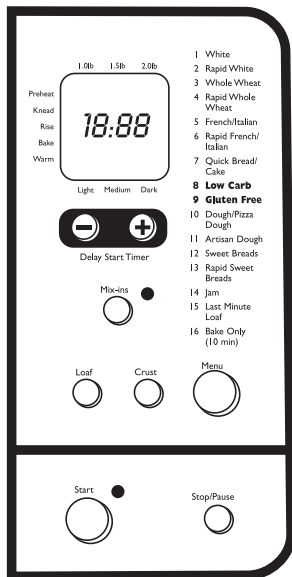

**Menu** – The Cuisinart™ Convection Bread Maker offers 16 different menu cycles. Press the Menu button to scroll through and select a cycle. The numbers on the LCD will correspond with the numbers on the control panel. Please see list of program options on pages 6–7 for reference.

**Crust** – Press Crust to select desired crust color. An indicator arrow will appear above the color selected: Light, Medium or Dark. The machine automatically defaults to Medium.

**Loaf** – Press Loaf to select desired loaf size: (1 LB, 1.5 LB or 2 LB)

An indicator arrow will appear below the size selected. The machine will automatically default to 2 LB.

Some menu cycles are limited to certain loaf options, and the LCD panel will display accordingly. Please see selection options on pages 6–7 for all available combinations.

**Start** – Press Start to start the program selected, and to resume after Pause. The red LED indicator will remain on during the Preheat, Knead, Rise and Bake cycle. The LED indicator will flash on/off during the Keep Warm function.

If you hear a beep after pressing a button, the beep is indicating an invalid choice. For example, Crust selection is not available for Dough, Jam and Bake Only programs. There will be an error beep if the Crust button is pressed after selecting these menu options.

**Stop/Pause** – Press this button once to pause the cycle. This will pause the machine for a maximum of 15 minutes, after which the unit will resume the set menu program. To reactivate before 15 minutes, simply press Start again.

**Press this button once and hold for three seconds to stop machine.**

## OPERATING INSTRUCTIONS

1. Remove bread pan and attach kneading paddle.
2. Properly measure all ingredients into the bread pan in the exact order they are listed. Always put the liquids in first, the dry ingredients in next, and the yeast last. Yeast cannot be allowed to touch wet ingredients.

Please refer to the measuring and loading ingredients sections (page 13) for instructions.

- Insert the bread pan back into the baking chamber. Press firmly so that the bread pan fits securely within the two brackets.
- Close the lid and connect power cord to standard electrical outlet.
- Choose Menu option. Press Menu and scroll through the 16 menu cycles until you reach your preferred cycle. The corresponding menu number will be indicated on the LCD screen. Please note: You will need to scroll through the list again if you pass your preferred cycle.

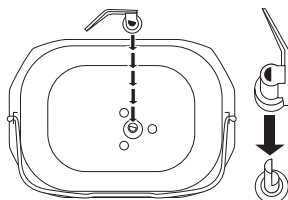
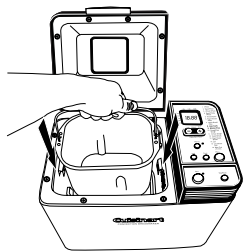

- Select Crust color – Press Crust to choose your preferred crust: Light, Medium or Dark. The Cuisinart™ Convection Bread Maker will automatically default to medium crust.  
**Please note:** the crust control feature will not operate for Dough, Jam and Bake Only cycles. If you choose an invalid option, you will hear an error beep.
- Select Loaf Size – Press Loaf to choose your preferred dough size: 1, 1.5 or 2 LB. The Cuisinart™ Convection Bread Maker will automatically default to a 2 LB loaf size.

**Please note:** the Loaf control feature will not operate for all menu options, such as Jam and Bake Only cycles. Gluten-free and Low-Carb settings do not offer 1-pound setting. If you choose an invalid option, you will hear an error beep.

**See a full list of Program Options (page 6).**

- Mix-ins feature – There are some wonderful recipes for fruit and nut breads, olive loaf, cheese bread, and so on, which require mix-in ingredients such as fruit and nuts, to be added after basic ingredients are kneaded.

The Mix-ins option will automatically default to on except for Low Carb, Quick Bread, Gluten Free or Last Minute Loaf programs. Press Mix-ins once if you choose to deactivate this feature. The LED light will indicate whether the signal is on or off. The signal can be set or deactivated anytime before the second knead cycle.

The Mix-ins signal will sound (if activated) at 14 minutes before the end of the second knead. This signal consists of a series of four sets of 5 long beeps each.

When you hear the signal, carefully open the bread maker lid and add any additional mix-ins the recipe requires. Gently close the lid to continue baking.

**Please note:** There are no Mix-ins signals for Low Carb, Quick Bread, Gluten Free or Last Minute Loaf program options. Mix-ins must be added at the very beginning of the cycle with other basic ingredients.

- You can press Start at this stage or activate Delay Start Timer.

**Never use the delay feature if your recipe includes ingredients which can spoil (eggs, milk or milk products, meat, fish, and so on).**

See Tips and Hints (pages 14–15) for important advice on using this feature.

The Cuisinart™ Convection Bread Maker gives you the convenient option of choosing the exact time your bread will be fresh and warm and ready to eat! Your bread maker has a delay setting up to 12 hours. **The time you set relates to the finish-time of baking the loaf.** Simply set the Delay Start Timer the number of hours ahead that you want the loaf to finish. Press the + or – buttons to set time for completion up to 12 hours later. Press to increase or decrease time by 10-minute increments or hold either button down for continuous movement.

In other words, if you decide in the morning that you would like a warm loaf of bread for dinner at 7 pm, simply set the Delay Start Timer the number of hours ahead to the time you want the loaf to finish. If it's 8 in the morning you can place your ingredients in the bread maker and set the delay timer to read 11:00. At 7 pm, eleven hours later, the end bake signal will sound to let you know that the bread is ready.

10. Press Start to begin baking process. An indicator arrow on the LCD will indicate the current function: Preheat, Knead, Rise, Bake, Keep Warm.

The first knead cycle will actually mix the basic ingredients. Three kneads are standard for most bread settings. The first knead is a few minutes, followed by a longer knead. There are periods of resting in which the unit will not be active except for the countdown display. These are rise cycles.

Once you choose a menu program and press Start, the unit will automatically take care of each step for you until the loaf finishes baking. If you choose a recipe with mix-ins such as fruits and nuts, the unit will signal the time to add these ingredients and the Mix-ins light will flash. See operating instruction #8 (page 4).

11. Remove paddle signal: For your convenience, there will be an audible signal before the last rise cycle, indicating the point at which the mixing/kneading is complete, and the paddle can be removed (to avoid a small hole in the bottom of your baked loaf).

Signal consists of a series of three sets of 6 quick beeps each.

If you want to remove the paddle at this time, or remove and re-shape the dough before replacing in bread pan, press Pause. Using oven mitts, open the lid and remove the bread pan by the handles. Close lid. The bread machine will pause for 15 minutes before automatically resuming.

Take the dough from pan and remove paddle. Form dough into a neat ball and replace in center of bread pan. Replace pan in bread maker. As soon as you replace bread pan and dough in machine, press Start again to resume baking program.

If you plan to remove the dough and reshape in another pan for baking in your conventional oven, this signal is an indication of the appropriate time for that too. Be sure to press Stop to reset the machine before it continues on to Rise, Bake and Keep Warm cycles. (Machine would automatically resume after 15 minutes.)

12. When the baking cycle is complete the end bake signal will sound. The bread display window will indicate unit is in Warm cycle and time will read 00:00.

Using oven mitts, open the lid and remove the bread pan by the handle. **Please note:** If you do not Stop the machine and remove your bread, the bread maker will automatically switch to its keep warm feature. Your bread will be kept warm for 60 minutes to prevent your loaf from becoming soggy. For optimal results, we recommend removing your loaf as soon as the baking cycle is complete, and letting it cool on a baking rack.

**Please note:** The keep warm function will not operate for any Dough, Jam and Bake Only cycles.

13. Remove bread from pan – Using oven mitts, grab the bottom of the bread pan, move handle aside, and shake until the bread is released.

For best results, allow the loaf to cool on a wire rack for 20 to 30 minutes prior to cutting.

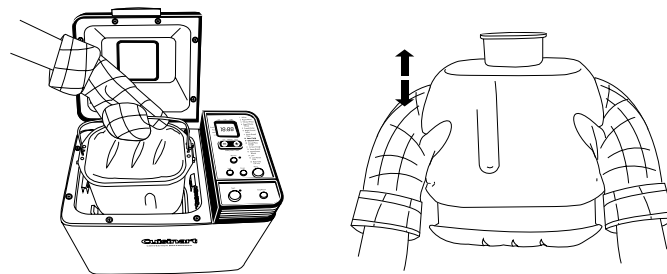

**Please note:** Be sure to remove the kneading paddle from the finished loaf. **Caution: the kneading paddle will be extremely hot.**

## POWER FAILURE BACKUP

This unit is equipped with a power failure backup system. In case of any disruption of power supply, the unit will store in memory the stage of bread making cycle and resume once power is restored. The power backup feature can maintain memory for a power failure up to 15 minutes.

---

## PROGRAM OPTIONS

Select from these Bread/Dough Cycles:

1. White Bread Light (1 LB)
2. White Bread Light (1.5 LB)
3. White Bread Light (2 LB)
4. White Bread Medium (1 LB)
5. White Bread Medium (1.5 LB)
6. White Bread Medium (2 LB)
7. White Bread Dark (1 LB)
8. White Bread Dark (1.5 LB)
9. White Bread Dark (2 LB)
10. White Bread Rapid Light (1 LB)
11. White Bread Rapid Light (1.5 LB)
12. White Bread Rapid Light (2 LB)
13. White Bread Rapid Medium (1 LB)
14. White Bread Rapid Medium (1.5 LB)
15. White Bread Rapid Medium (2 LB)
16. White Bread Rapid Dark (1 LB)
17. White Bread Rapid Dark (1.5 LB)
18. White Bread Rapid Dark (2 LB)
19. Whole Wheat Bread Light (1 LB)
20. Whole Wheat Bread Light (1.5 LB)
21. Whole Wheat Bread Light (2 LB)
22. Whole Wheat Bread Medium (1 LB)
23. Whole Wheat Bread Medium (1.5 LB)
24. Whole Wheat Bread Medium (2 LB)
25. Whole Wheat Bread Dark (1 LB)
26. Whole Wheat Bread Dark (1.5 LB)
27. Whole Wheat Bread Dark (2 LB)
28. Whole Wheat Bread Rapid Light (1 LB)
29. Whole Wheat Bread Rapid Light (1.5 LB)
30. Whole Wheat Bread Rapid Light (2 LB)
31. Whole Wheat Bread Rapid Medium (1 LB)
32. Whole Wheat Bread Rapid Medium (1.5 LB)
33. Whole Wheat Bread Rapid Medium (2 LB)
34. Whole Wheat Bread Rapid Dark (1 LB)
35. Whole Wheat Bread Rapid Dark (1.5 LB)
36. Whole Wheat Bread Rapid Dark (2 LB)
37. French/Italian Bread Light (1 LB)
38. French/Italian Bread Light (1.5 LB)
39. French/Italian Bread Light (2 LB)
40. French/Italian Bread Medium (1 LB)
41. French/Italian Bread Medium (1.5 LB)
42. French/Italian Bread Medium (2 LB)
43. French/Italian Bread Dark (1 LB)
44. French/Italian Bread Dark (1.5 LB)
45. French/Italian Bread Dark (2 LB)
46. French/Italian Bread Rapid Light (1 LB)
47. French/Italian Bread Rapid Light (1.5 LB)
48. French/Italian Bread Rapid Light (2 LB)
49. French/Italian Bread Rapid Medium (1 LB)



- 
50. French/Italian Bread Rapid Medium (1.5 LB)
  51. French/Italian Bread Rapid Medium (2 LB)
  52. French/Italian Bread Rapid Dark (1 LB)
  53. French/Italian Bread Rapid Dark (1.5 LB)
  54. French/Italian Bread Rapid Dark (2 LB)
  55. Quick Bread/Cake Light (1 LB)
  56. Quick Bread/Cake Light (1.5 LB)
  57. Quick Bread/Cake Light (2 LB)
  58. Quick Bread/Cake Medium (1 LB)
  59. Quick Bread/Cake Medium (1.5 LB)
  60. Quick Bread/Cake Medium (2 LB)
  61. Quick Bread/Cake Dark (1 LB)
  62. Quick Bread/Cake Dark (1.5 LB)
  63. Quick Bread/Cake Dark (2 LB)
  64. Gluten-Free Light (1.5 LB)
  65. Gluten-Free Light (2 LB)
  66. Gluten-Free Medium (1.5 LB)
  67. Gluten-Free Medium (2 LB)
  68. Gluten-Free Dark (1.5 LB)
  69. Gluten-Free Dark (2 LB)
  70. Low-Carb Light (1.5 LB)
  71. Low-Carb Light (2 LB)
  72. Low-Carb Medium (1.5 LB)
  73. Low-Carb Medium (2 LB)
  74. Low-Carb Dark (1.5 LB)
  75. Low-Carb Dark (2 LB)
  76. Dough/Pizza Dough (1 LB)
  77. Dough/Pizza Dough (1.5 LB)
  78. Dough/Pizza Dough (2 LB)
  79. Artisan Dough
  80. Sweet Breads Light (1 LB)
  81. Sweet Breads Light (1.5 LB)
  82. Sweet Breads Light (2 LB)
  83. Sweet Breads Medium (1 LB)
  84. Sweet Breads Medium (1.5 LB)
  85. Sweet Breads Medium (2 LB)
  86. Sweet Breads Dark (1 LB)
  87. Sweet Breads Dark (1.5 LB)
  88. Sweet Breads Dark (2 LB)
  89. Sweet Breads Rapid Light (1 LB)
  90. Sweet Breads Rapid Light (1.5 LB)
  91. Sweet Breads Rapid Light (2 LB)
  92. Sweet Breads Rapid Medium (1 LB)
  93. Sweet Breads Rapid Medium (1.5 LB)
  94. Sweet Breads Rapid Medium (2 LB)
  95. Sweet Breads Rapid Dark (1 LB)
  96. Sweet Breads Rapid Dark (1.5 LB)
  97. Sweet Breads Rapid Dark (2 LB)
  98. Jam
  99. Last-Minute Loaf Medium (1.5 LB)
  100. Last-Minute Loaf Medium (2.0 LB)
  101. Bake Only

---

## TYPES OF BREAD

**White** – The white bread cycle uses primarily white flour.

**Whole wheat bread** – Whole wheat bread is a yeast bread that is made with a significant portion of whole wheat flour (50% or more), rather than with all white bread flour. Breads made from whole wheat flour are more nutritious because the flour is milled from the entire wheat berry (including the bran and the germ). Using whole wheat flour produces a bread that is brown to dark brown in color (when all whole wheat flour is used), and the breads are more flavorful and healthful than breads made with refined white flours (even though “lost” nutrients are added back into white flours).

**French/Italian** – French/Italian breads require special timing and temperatures to achieve that wonderful crispy, nicely browned crust.

**Quick bread** – (Referred to as batter breads in some cookbooks.) Cake-like in texture, they are usually baked in a shaped pan such as a muffin tin or loaf pan. They are a batter-type bread rather than a yeast dough, and get their leavening from baking powder, baking soda and eggs. Mix-ins must be added at the very beginning of the cycle with other basic ingredients.

If a quick bread is a little moist on top when baking is complete (moisture will depend on ingredients of the quick bread), leave it in the bread maker for an extra 10 to 15 minutes with no heat, and it will continue baking – this is called “after cooking.”

**Sweet bread** – The Sweet Breads settings are for baking breads with high amounts of sugar, fats and proteins, all of which tend to increase browning.

**Low-carb** – Low-carb baking is unique in its ingredients. Because low/lower-carb breads are low in sugar, the baking time is different. It is also important not to over-mix or over-knead when preparing low/lower-carb breads. Our exclusive low-carb setting assures proper kneading and baking times. Mix-ins must be added at the very beginning of the cycle with other basic ingredients.

**Gluten-free** – One in approximately 100 people has an allergy or sensitivity to gluten. Since gluten is found in most flours used in traditional bread baking, the ingredients to create gluten-free breads are unique. While they are “yeast breads,” the doughs are generally wetter and more like a batter. It is also important not to over-mix or over-knead gluten-free doughs. There is only

one rise, and due to the high moisture content, baking time is increased. Our exclusive gluten-free setting makes it easy to get the right results. Mix-ins must be added at the very beginning of the cycle with other basic ingredients.

**Dough/pizza dough** – There are two ways for preparing dough in the bread maker, if you intend to bake your bread, rolls, cakes, and so on, in your conventional oven.

Our Dough/pizza dough cycle mixes ingredients, kneads and takes the dough through the first rise cycle. It is appropriate for almost any dough recipe (except gluten-free or low-carb) and ideal for pizza or pretzel dough.

It is intended that dough will be removed, deflated and shaped by hand and allowed to rise 1 or 2 more times out of the bread maker (see pages 49–64 for recipes).

Alternatively, you can choose a specific bread type from the menu options, and remove the dough when the signal before last rise sounds. This will take you through two rise cycles.

This method is suitable for any alternate loaf shape, round loaf, dinner rolls, braided challah bread, and so on. Last rise will take place outside the bread maker.

**Artisan dough** – This cycle allows the preparation of artisan breads. There are several long, slow, cool rises that will enhance the development of texture, taste and crust in the final shaped and baked bread.

**Rapid** – Rapid cycle options are provided for a number of menu choices: white bread, wheat bread, French/Italian and quick bread. The time saving is achieved with the use of rapid rise yeast. Any rapid cycle must be used with a recipe using rapid rise yeast, or the bread will not rise and bake properly. Almost any recipe can be modified by replacing standard yeast with an equal or larger amount of rapid rise yeast.

**Jams and chutneys** – The bread maker is a great cooking environment for homemade jams and chutneys. The paddle automatically keeps the ingredients stirring through the process. The heating element is placed in a way that the contents of the pot will not get burned. We provide recipes starting on page 79 to get you started. They make a wonderful complement to freshly baked bread!

---

Note: During jam cycle, tones will sound at 5 minutes and 10 minutes into program, as a recommendation to clear sides of the pan with a spatula.

**Last-minute Loaf** – The Last-Minute Loaf is a fast bake cycle, which goes through kneading, rising and baking in approximately an hour. Mix-ins must be added at the very beginning of the cycle with other basic ingredients.

**Please note: Because they are added at the beginning, there will be no signal indicating mix-ins.**

This function can come in handy when you cannot plan ahead for bread making. The Last-Minute Loaf cycle requires the use of rapid rising yeast. Recipes begin on page 84 of recipe section. **The kneading and rising of this cycle is suitable for white bread recipes.** Allow it to cool before cutting or allow to remain in the bread maker for 60 minutes on Keep Warm cycle before serving.

**Bake Only** – This menu setting activates the bread maker for bake function only, and can be set in 10-minute intervals up to 90 minutes. You can use this setting if you want the finished loaf to have darker crust color (this will only require a few extra minutes, so keep your eye on the loaf). Bake Only can also be used to bake store-purchased doughs.

## CYCLES OF BREAD MAKING

**Knead** – There are typically 3 knead cycles for most bread types. The first knead cycle will actually mix the ingredients. Mix-ins can be added during the second knead. The one or two other short knead cycles will punch the dough down before the rise cycles.

**Rise** – There are periods of resting in which the unit will not be active except for the countdown display. These are rise cycles. A good rise is as important to the flavor of your bread as kneading and baking. During the rise, the machine will appear inactive – the dough is “at work”.

**Bake** – The Cuisinart™ Convection Bread Maker will regulate the baking time and temperature according to the individual recipe.

**Convection feature** – A fan circulates air throughout baking cycles for better overall browning and crispier crust. The convection feature runs during Bake Only and Keep Warm only.

**Warm** – The Keep Warm cycle allows you to leave the finished bread in the machine to serve warm. It also helps keep the crust from becoming soggy if not removed from the machine immediately after baking. Some crusts will darken slightly in Keep Warm mode. For best results it is recommended to remove finished loaf as soon as baking cycle is complete. Cool on a baking rack.

## AUDIBLE TONES

**Mix-ins** – The signal consists of a series of four sets of 5 long beeps each at 14 minutes before the end of the second knead (page 4, #8).

**Remove Paddle** – The signal consists of a series of three sets of 6 quick beeps before last rise (page 5, #11).

**Baking Cycle Complete** – At the end of the baking cycle a series of 10 beeps will sound when the cycle is done (page 5, #12).

**Keep Warm Function** – There will be a series of 12 beeps after the completion of the keep warm function.

**Jam Program Only** – Tones will sound at 5 minutes and 10 minutes into program (page 8) as a recommendation to clean sides of the pan with a spatula.

**Error Beep** – There will be an error beep if you press an invalid function (page 4, #6 and #7).

# TIMETABLE FOR THE CUISINART™ CONVECTION BREAD MAKER

AUDIBLE TONES\*

NO.	Cycle	Crust	Size	Preheat	Knead 1	Knead 2	Rise 1	Knead 3	Rise 2	Knead 4	Rise 3	Bake	Total	Keep Warm	Mix-ins	Remove Paddle	
1	White	Light	1.0LB	0MIN	3MIN	31MIN	26MIN	15SEC	25MIN	15SEC	55MIN	37M	2:57	60	2:37	1:32	
			1.5LB	0MIN	3MIN	31MIN	26MIN	15SEC	25MIN	15SEC	55MIN	40M	3:00	60	2:40	1:35	
			2.0LB	0MIN	3MIN	31MIN	26MIN	15SEC	25MIN	15SEC	55MIN	43M	3:03	60	2:43	1:38	
		Medium	Light	1.0LB	0MIN	3MIN	31MIN	26MIN	15SEC	25MIN	15SEC	55MIN	45M	3:05	60	2:45	1:40
				1.5LB	0MIN	3MIN	31MIN	26MIN	15SEC	25MIN	15SEC	55MIN	50M	3:10	60	2:50	1:45
				2.0LB	0MIN	3MIN	31MIN	26MIN	15SEC	25MIN	15SEC	55MIN	55M	3:15	60	2:55	1:50
		Dark	Light	1.0LB	0MIN	3MIN	31MIN	26MIN	15SEC	25MIN	15SEC	55MIN	60M	3:20	60	3:00	1:55
				1.5LB	0MIN	3MIN	31MIN	26MIN	15SEC	25MIN	15SEC	55MIN	65M	3:25	60	3:05	2:00
				2.0LB	0MIN	3MIN	31MIN	26MIN	15SEC	25MIN	15SEC	55MIN	70M	3:30	60	3:10	2:05
2	Rapid White	Light	1.0LB	0MIN	3MIN	31MIN	26MIN	15SEC	55MIN	0SEC	0MIN	37M	2:32	60	2:12	1:32	
			1.5LB	0MIN	3MIN	31MIN	26MIN	15SEC	55MIN	0SEC	0MIN	40M	2:35	60	2:15	1:35	
			2.0LB	0MIN	3MIN	31MIN	26MIN	15SEC	55MIN	0SEC	0MIN	43M	2:38	60	2:18	1:38	
		Medium	Light	1.0LB	0MIN	3MIN	31MIN	26MIN	15SEC	55MIN	0SEC	0MIN	45M	2:40	60	2:20	1:40
				1.5LB	0MIN	3MIN	31MIN	26MIN	15SEC	55MIN	0SEC	0MIN	50M	2:45	60	2:25	1:45
				2.0LB	0MIN	3MIN	31MIN	26MIN	15SEC	55MIN	0SEC	0MIN	55M	2:50	60	2:30	1:50
		Dark	Light	1.0LB	0MIN	3MIN	31MIN	26MIN	15SEC	55MIN	0SEC	0MIN	60M	2:55	60	2:35	1:55
				1.5LB	0MIN	3MIN	31MIN	26MIN	15SEC	55MIN	0SEC	0MIN	65M	3:00	60	2:40	2:00
				2.0LB	0MIN	3MIN	31MIN	26MIN	15SEC	55MIN	0SEC	0MIN	70M	3:05	60	2:45	2:05
3	Whole Wheat	Light	1.0LB	30MIN	3MIN	25MIN	80MIN	15SEC	31MIN	15SEC	46MIN	40M	4:15	60	3:31	1:26	
			1.5LB	30MIN	3MIN	25MIN	80MIN	15SEC	31MIN	15SEC	46MIN	44M	4:19	60	3:35	1:30	
			2.0LB	30MIN	3MIN	25MIN	80MIN	15SEC	31MIN	15SEC	46MIN	48M	4:23	60	3:39	1:34	
		Medium	Light	1.0LB	30MIN	3MIN	25MIN	80MIN	15SEC	31MIN	15SEC	46MIN	45M	4:20	60	3:36	1:31
				1.5LB	30MIN	3MIN	25MIN	80MIN	15SEC	31MIN	15SEC	46MIN	50M	4:25	60	3:41	1:36
				2.0LB	30MIN	3MIN	25MIN	80MIN	15SEC	31MIN	15SEC	46MIN	55M	4:30	60	3:46	1:41
		Dark	Light	1.0LB	30MIN	3MIN	25MIN	80MIN	15SEC	31MIN	15SEC	46MIN	54M	4:29	60	3:45	1:40
				1.5LB	30MIN	3MIN	25MIN	80MIN	15SEC	31MIN	15SEC	46MIN	60M	4:35	60	3:51	1:46
				2.0LB	30MIN	3MIN	25MIN	80MIN	15SEC	31MIN	15SEC	46MIN	64M	4:39	60	3:55	1:50
4	Rapid Whole Wheat	Light	1.0LB	5MIN	3MIN	25MIN	30MIN	15SEC	46MIN	0SEC	0MIN	40M	2:29	60	2:10	1:26	
			1.5LB	5MIN	3MIN	25MIN	30MIN	15SEC	46MIN	0SEC	0MIN	44M	2:33	60	2:14	1:30	
		Medium	Light	1.0LB	5MIN	3MIN	25MIN	30MIN	15SEC	46MIN	0SEC	0MIN	48M	2:37	60	2:18	1:34
				1.5LB	5MIN	3MIN	25MIN	30MIN	15SEC	46MIN	0SEC	0MIN	45M	2:34	60	2:15	1:31
				2.0LB	5MIN	3MIN	25MIN	30MIN	15SEC	46MIN	0SEC	0MIN	50M	2:39	60	2:20	1:36

\*Audible tones will sound at specified time listed in chart above as a reminder to add Mix-ins or remove paddle.

															AUDIBLE TONES*	
NO.	Cycle	Crust	Size	Preheat	Knead 1	Knead 2	Rise 1	Knead 3	Rise 2	Knead 4	Rise 3	Bake	Total	Keep Warm	Mix-ins	Remove Paddle
			2.0LB	5MIN	3MIN	25MIN	30MIN	15SEC	46MIN	0SEC	0MIN	55M	2:44	60	2:25	1:41
		Dark	1.0LB	5MIN	3MIN	25MIN	30MIN	15SEC	46MIN	0SEC	0MIN	54M	2:43	60	2:24	1:40
			1.5LB	5MIN	3MIN	25MIN	30MIN	15SEC	46MIN	0SEC	0MIN	60M	2:49	60	2:30	1:46
			2.0LB	5MIN	3MIN	25MIN	30MIN	15SEC	46MIN	0SEC	0MIN	64M	2:53	60	2:34	1:50
5	French/Italian	Light	1.0LB	0MIN	3MIN	30MIN	32MIN	15SEC	30MIN	15SEC	55MIN	42M	3:12	60	2:53	1:37
			1.5LB	0MIN	3MIN	30MIN	32MIN	15SEC	30MIN	15SEC	55MIN	53M	3:23	60	3:04	1:48
			2.0LB	0MIN	3MIN	30MIN	32MIN	15SEC	30MIN	15SEC	55MIN	64M	3:34	60	3:15	1:59
		Medium	1.0LB	0MIN	3MIN	30MIN	32MIN	15SEC	30MIN	15SEC	55MIN	62M	3:32	60	3:13	1:57
			1.5LB	0MIN	3MIN	30MIN	32MIN	15SEC	30MIN	15SEC	55MIN	66M	3:36	60	3:17	2:01
			2.0LB	0MIN	3MIN	30MIN	32MIN	15SEC	30MIN	15SEC	55MIN	70M	3:40	60	3:21	2:05
		Dark	1.0LB	0MIN	3MIN	30MIN	32MIN	15SEC	30MIN	15SEC	55MIN	65M	3:35	60	3:16	2:00
			1.5LB	0MIN	3MIN	30MIN	32MIN	15SEC	30MIN	15SEC	55MIN	72M	3:42	60	3:23	2:07
			2.0LB	0MIN	3MIN	30MIN	32MIN	15SEC	30MIN	15SEC	55MIN	74M	3:44	60	3:25	2:09
6	Rapid French/Italian	Light	1.0LB	0MIN	3MIN	30MIN	26MIN	15SEC	55MIN	0SEC	0MIN	42M	2:36	60	2:17	1:37
			1.5LB	0MIN	3MIN	30MIN	26MIN	15SEC	55MIN	0SEC	0MIN	53M	2:47	60	2:28	1:48
			2.0LB	0MIN	3MIN	30MIN	26MIN	15SEC	55MIN	0SEC	0MIN	64M	2:58	60	2:39	1:59
		Medium	1.0LB	0MIN	3MIN	30MIN	26MIN	15SEC	55MIN	0SEC	0MIN	62M	2:56	60	2:37	1:57
			1.5LB	0MIN	3MIN	30MIN	26MIN	15SEC	55MIN	0SEC	0MIN	66M	3:00	60	2:41	2:01
			2.0LB	0MIN	3MIN	30MIN	26MIN	15SEC	55MIN	0SEC	0MIN	70M	3:04	60	2:45	2:05
		Dark	1.0LB	0MIN	3MIN	30MIN	26MIN	15SEC	55MIN	0SEC	0MIN	65M	2:59	60	2:40	2:00
			1.5LB	0MIN	3MIN	30MIN	26MIN	15SEC	55MIN	0SEC	0MIN	72M	3:06	60	2:47	2:07
			2.0LB	0MIN	3MIN	30MIN	26MIN	15SEC	55MIN	0SEC	0MIN	74M	3:08	60	2:49	2:09
7	Quick Bread/Cake	Light	1.0LB	0MIN	3MIN	5MIN	0MIN	0SEC	0MIN	0SEC	0MIN	73M	1:21	22	N/A	1:13
			1.5LB	0MIN	3MIN	5MIN	0MIN	0SEC	0MIN	0SEC	0MIN	97M	1:45	22	N/A	1:37
			2.0LB	0MIN	3MIN	5MIN	0MIN	0SEC	0MIN	0SEC	0MIN	118M	2:06	22	N/A	1:58
		Medium	1.0LB	0MIN	3MIN	5MIN	0MIN	0SEC	0MIN	0SEC	0MIN	75M	1:23	22	N/A	1:15
			1.5LB	0MIN	3MIN	5MIN	0MIN	0SEC	0MIN	0SEC	0MIN	99M	1:47	22	N/A	1:39
			2.0LB	0MIN	3MIN	5MIN	0MIN	0SEC	0MIN	0SEC	0MIN	120M	2:08	22	N/A	2:00
		Dark	1.0LB	0MIN	3MIN	5MIN	0MIN	0SEC	0MIN	0SEC	0MIN	77M	1:25	22	N/A	1:17
			1.5LB	0MIN	3MIN	5MIN	0MIN	0SEC	0MIN	0SEC	0MIN	101M	1:49	22	N/A	1:41
			2.0LB	0MIN	3MIN	5MIN	0MIN	0SEC	0MIN	0SEC	0MIN	122M	2:10	22	N/A	2:02
8	Low Carb	Light	1.5LB	3MIN	4MIN	9MIN	15MIN	10SEC	75MIN	0SEC	0MIN	73M	2:59	60	N/A	2:28
			2.0LB	3MIN	4MIN	9MIN	15MIN	10SEC	75MIN	0SEC	0MIN	82M	3:08	60	N/A	2:37

\*Audible tones will sound at specified time listed in chart above as a reminder to add Mix-ins or remove paddle.

															AUDIBLE TONES*	
NO.	Cycle	Crust	Size	Preheat	Knead 1	Knead 2	Rise 1	Knead 3	Rise 2	Knead 4	Rise 3	Bake	Total	Keep Warm	Mix-ins	Remove Paddle
		Medium	1.5LB	3MIN	4MIN	9MIN	15MIN	10SEC	75MIN	0SEC	0MIN	75M	3:01	60	N/A	2:30
			2.0LB	3MIN	4MIN	9MIN	15MIN	10SEC	75MIN	0SEC	0MIN	84M	3:10	60	N/A	2:39
		Dark	1.5LB	3MIN	4MIN	9MIN	15MIN	10SEC	75MIN	0SEC	0MIN	77M	3:03	60	N/A	2:32
			2.0LB	3MIN	4MIN	9MIN	15MIN	10SEC	75MIN	0SEC	0MIN	86M	3:12	60	N/A	2:41
9	Gluten Free	Light	1.5LB	8MIN	4MIN	19MIN	48MIN	0SEC	0MIN	0SEC	0MIN	78M	2:37	60	N/A	2:06
			2.0LB	8MIN	4MIN	19MIN	48MIN	0SEC	0MIN	0SEC	0MIN	83M	2:42	60	N/A	2:11
		Medium	1.5LB	8MIN	4MIN	19MIN	48MIN	0SEC	0MIN	0SEC	0MIN	80M	2:39	60	N/A	2:08
			2.0LB	8MIN	4MIN	19MIN	48MIN	0SEC	0MIN	0SEC	0MIN	85M	2:44	60	N/A	2:13
		Dark	1.5LB	8MIN	4MIN	19MIN	48MIN	0SEC	0MIN	0SEC	0MIN	82M	2:41	60	N/A	2:10
			2.0LB	8MIN	4MIN	19MIN	48MIN	0SEC	0MIN	0SEC	0MIN	87M	2:46	60	N/A	2:15
10	Dough/Pizza Dough	N/A	1.0LB	0MIN	3MIN	24MIN	58MIN	0SEC	0MIN	0SEC	0MIN	0M	1:25	N/A	1:12	N/A
			1.5LB	0MIN	3MIN	27MIN	60MIN	0SEC	0MIN	0SEC	0MIN	0M	1:30	N/A	1:14	N/A
			2.0LB	0MIN	3MIN	32MIN	65MIN	0SEC	0MIN	0SEC	0MIN	0M	1:40	N/A	1:19	N/A
11	Artisan Dough	N/A	N/A	0MIN	5MIN	35MIN	70MIN	1SEC	85MIN	10SEC	110MIN	0M	5:05	N/A	4:39	N/A
12	Sweet Breads	Light	1.0LB	0MIN	3MIN	31MIN	31MIN	15SEC	30MIN	15SEC	50MIN	52M	3:17	60	2:57	1:22
			1.5LB	0MIN	3MIN	31MIN	31MIN	15SEC	30MIN	15SEC	50MIN	54M	3:19	60	2:59	1:24
			2.0LB	0MIN	3MIN	31MIN	31MIN	15SEC	30MIN	15SEC	50MIN	56M	3:21	60	3:01	1:26
		Medium	1.0LB	0MIN	3MIN	31MIN	31MIN	15SEC	30MIN	15SEC	50MIN	54M	3:19	60	2:59	1:24
			1.5LB	0MIN	3MIN	31MIN	31MIN	15SEC	30MIN	15SEC	50MIN	57M	3:22	60	3:02	1:27
			2.0LB	0MIN	3MIN	31MIN	31MIN	15SEC	30MIN	15SEC	50MIN	60M	3:25	60	3:05	1:30
		Dark	1.0LB	0MIN	3MIN	31MIN	31MIN	15SEC	30MIN	15SEC	50MIN	58M	3:23	60	3:03	1:28
			1.5LB	0MIN	3MIN	31MIN	31MIN	15SEC	30MIN	15SEC	50MIN	61M	3:26	60	3:06	1:31
			2.0LB	0MIN	3MIN	31MIN	31MIN	15SEC	30MIN	15SEC	50MIN	64M	3:29	60	3:09	1:34
13	Rapid Sweet Breads	Light	1.0LB	0MIN	3MIN	31MIN	31MIN	15SEC	50MIN	0SEC	0MIN	52M	2:47	60	2:27	1:42
			1.5LB	0MIN	3MIN	31MIN	31MIN	15SEC	50MIN	0SEC	0MIN	54M	2:49	60	2:29	1:44
			2.0LB	0MIN	3MIN	31MIN	31MIN	15SEC	50MIN	0SEC	0MIN	56M	2:51	60	2:31	1:46
		Medium	1.0LB	0MIN	3MIN	31MIN	31MIN	15SEC	50MIN	0SEC	0MIN	54M	2:49	60	2:29	1:44
			1.5LB	0MIN	3MIN	31MIN	31MIN	15SEC	50MIN	0SEC	0MIN	57M	2:52	60	2:32	1:47
			2.0LB	0MIN	3MIN	31MIN	31MIN	15SEC	50MIN	0SEC	0MIN	60M	2:55	60	2:35	1:50
		Dark	1.0LB	0MIN	3MIN	31MIN	31MIN	15SEC	50MIN	0SEC	0MIN	58M	2:53	60	2:33	1:48
			1.5LB	0MIN	3MIN	31MIN	31MIN	15SEC	50MIN	0SEC	0MIN	61M	2:56	60	2:36	1:51
			2.0LB	0MIN	3MIN	31MIN	31MIN	15SEC	50MIN	0SEC	0MIN	64M	2:59	60	2:39	1:54
14	Jam			0MIN	0MIN	15MIN	0MIN	0SEC	0MIN	0SEC	0MIN	70M	1:25	20	N/A	NA

\*Audible tones will sound at specified time listed in chart above as a reminder to add Mix-ins or remove paddle.

NO.	Cycle	Crust	Size	Pre-Heat	Knead 1	Knead 2	Rise 1	Knead 3	Rise 2	Knead 4	Rise 3	Bake	Total	Keep Warm
15	Last Minute Loaf	Medium	1.5LB	0MIN	1MIN	10MIN	0MIN	0SEC	0MIN	0SEC	11MIN	37M	0:59	60
			2.0LB	0MIN	1MIN	10MIN	0MIN	0SEC	0MIN	0SEC	14MIN	40M	1:05	60
16	Bake Only			0MIN	0MIN	0MIN	0MIN	0SEC	0MIN	0SEC	0MIN	10M	0:10	60

AUDIBLE TONES*	
Mix-ins	Remove Paddle
N/A	0:48
1:02	0:54
N/A	NA

\*Audible tones will sound at specified time listed in chart above as a reminder to add Mix-ins or remove paddle.

## MEASURING INGREDIENTS

**Important note: The MOST important rule of making bread: Use exact measurements. This is the key to successful bread baking.**

With wet ingredients, use only liquid measuring cups with the cups/ounces marked clearly on the side. After filling the measuring cup, place it on a flat surface and view it at eye level to make sure the amount of liquid is exact. Liquids must be room temperature.

With dry ingredients fill a dry measuring cup with a spoon and then level off the measurement with the back of a knife or a spatula to make sure the measurement is exact. Never use the cup to scoop the ingredients directly from container (for example, flour). By scooping, you could add up to one tablespoon of extra ingredients. Do not pack down.

## LOADING INGREDIENTS INTO THE BREAD PAN

**Important Note: The SECOND MOST important rule of making bread: Put the ingredients into the bread maker in the EXACT order given in the recipe.** This means:

- FIRST, liquid ingredients – room temperature
- SECOND, dry ingredients
- LAST, yeast – Yeast must be separate from wet ingredients. Create a small crater in dry ingredients using your finger or a spoon, and place yeast within the crater. Make sure yeast is fresh.

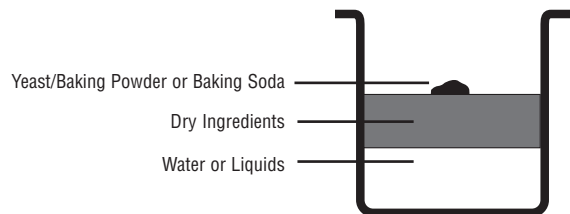

Also, make sure ALL ingredients are at room temperature, unless otherwise noted (that is, between 75°–90°F). Temperatures too cool or too warm can affect the way the bread rises and bakes. Note: Water should not be warm, or it will affect rising.

Last, it's a good idea to start with fresh ingredients. Fresh flour and fresh yeast are critical.

See troubleshooting section (pages 16–17) to learn more.

## MEASUREMENT/CONVERSION CHART

1½ teaspoons	= ½ tablespoon	8 tablespoons	= ½ cup
3 teaspoons	= 1 tablespoon	12 tablespoons	= ¾ cup
½ tablespoon	= 1½ teaspoons	16 tablespoons	= 1 cup
2 tablespoons	= ⅓ cup	¾ cup	= ¼ cup + 2 tablespoons
4 tablespoons	= ¼ cup	¾ cup	= ½ cup + 2 tablespoons
5 tablespoons + 1 teaspoon	= ⅓ cup	¾ cup	= ¾ cup + 2 tablespoons

---

## CLEANING INSTRUCTIONS

**Caution:** Do not put the bread maker in water or in a dishwasher. Do not use benzene, scrubbing brushes or chemical cleaners, as these will damage the machine. Use only a mild, nonabrasive cleanser to clean the outside of the bread maker.

**Baking pan and kneading paddle** – Pan and kneading blade are fully immersible and dishwasher safe. Do not use metal utensils with the baking pans as they will damage the nonstick surface.

**Baking chamber** – Remove all bread crumbs by wiping them away with a slightly damp cloth or clean pastry brush. DO NOT bend the heating element, which is located on the inside of the bread maker. Unplug machine before cleaning.

**Lid** – Wipe inside of lid with sponge or damp cloth. Lid should not be immersed in water.

**Outer Housing** – Use only a mild, nonabrasive cleanser to clean the outside of the bread maker.

**Control Panel** – Wipe with a slightly damp cloth as necessary. Take care not to allow water or cleaning fluids under buttons of control panel.

## CARING FOR YOUR BREAD MAKER

Keep your bread maker clean at all times.

**Caution:** Do not use metal utensils with the bread maker, as they will damage the non-stick pan and other parts.

Don't worry if the color of the baking pan changes over time. The color change is a result of steam and other moisture and does not affect the machine's performance.

If you have trouble removing the kneading paddle from bread pan, place warm water in the bread pan for 10 to 15 minutes – this will loosen the blade.

## TIPS AND HINTS

**For higher altitudes** – Flour is drier at higher altitude levels and will absorb more liquid – use less flour in the recipe. Pay attention to the dough as it mixes and kneads – if it appears dry, add more of the same liquid used in the recipe.

Doughs prepared and baked at higher altitude levels will tend to rise faster – use less yeast, a bit more salt, and a little less sugar to help counteract this phenomenon.

Bread rises higher in high altitudes – try reducing the recommended amount of yeast by  $\frac{1}{4}$ – $\frac{1}{2}$  teaspoon. If bread still rises too high, reduce yeast by another  $\frac{1}{4}$  teaspoon the next time you try the recipe.

Adding a little more salt will retard the yeast action and promote slower, more even rising.

Add vital gluten or lecithin. This will help to stabilize the structure of the bread and make it less likely to fall or collapse. Lecithin can be purchased in most health food stores or natural food markets.

For further information, try contacting the State Extension Service of a "high altitude" state.

### Usage

Bread machine baking is affected by the temperature and humidity of the day – this is often the cause of varied dough consistency and results. On a humid day, the best method of measuring is to weigh the flour. A cup of white bread flour weighs 5 ounces/140grams. A cup of whole wheat flour weighs 4 ounces/120 grams.

If you do not have a scale (electronic works best for measuring flour), let your eye and hands guide you in adding more flour or liquid as necessary. Dough should be smooth and not cling to fingers when touched.

Additional amounts of flour or liquid should be added 1 teaspoon at a time.

Giving the kneading paddle a light coating with a nonstick cooking spray, shortening or vegetable oil may make it easier to remove if it bakes into a loaf.



**Important:** If using perishable fresh ingredients such as dairy products, eggs, chopped fruits or vegetables, do not use the Delay Start Timer feature. Some dairy products and eggs may be substituted by using dried ingredients such as dried egg powders, dried buttermilk, or dry milk. Add the water to the machine first, then add the dried substitution after the flour to keep them separate. If you substitute these dried ingredients and have no other fresh, perishable ingredients in your bread recipe, you may then use the Delay Start Timer feature.

Use top quality ingredients to make your bread-machine breads.

Measure all ingredients accurately and have them ready before adding to bread pan. This is known as *mise en place* and helps to ensure that you measure each ingredient correctly, and do not find that you get down to the last (or nearly last) ingredient and find that it is not available in the pantry.

When measuring ingredients use liquid measuring utensils for liquids and dry measures for dry ingredients. Stir all “flours” first, spoon into dry measure and level off using the flat side of a knife or spatula – do not pack down. See detailed instructions on page 13.

Add ingredients to the pan in this order – liquids, melted or softened butter, salt and sugars (including honey, molasses, barley syrup), herbs, flours, dried milk, vital wheat gluten (if using), yeast. Do not allow the yeast to touch the wet ingredients. See detailed instructions on page 13.

Temperature of ingredients is important in bread machine baking. Ideal temperatures are between 75°–90°F. Use an instant-read thermometer to check the temperatures. Cold ingredients should be allowed to come to room temperature. Liquids and butter may be combined and placed in a microwave on the defrost setting to warm without heating too hot.

When adapting a recipe, do not omit the little amounts of ½ teaspoon or less – they are essential to the chemical composition of the bread.

Vital wheat gluten can be added to recipes to improve loaf height, texture and structure – particularly with whole grain flours, or breads using whole wheat, oat flour or rye flours. It also aids in rising when using the Rapid Rise cycles, and is essential to the Last-Minute Loaves.

It is especially important to keep yeast separate from salt if using Delay Start Timer feature – add salt with the liquids and the yeast last on top of the flour. See page 13.

Nuts and seeds, raisins and dried fruits, shredded cheeses, chocolate morsels, and any other additions to the dough should be added when the Mix-in signal sounds except for Low Carb, Quick Bread, Gluten Free, and Last Minute Loaf programs.

For a more uniform loaf of bread, remove the dough when you hear the remove paddle signal, then remove the kneading paddle and reshape the dough into a neat loaf. This will ensure a more uniformly shaped loaf of bread, particularly with the smaller 1-and 1½-pound loaves.

Use the Whole Wheat program when baking breads containing not only whole wheat flour, but other heavy flours that will require a longer knead and rise – an example of this would be pumpernickel bread.

All breads slice best when allowed to cool for a minimum of 30 minutes (preferably longer) before slicing. If you wish to serve bread warm, wrap in foil and heat in oven. (However, we recommend serving a Last-Minute Loaf warm).

For quick breads/batter breads, spray the bottom and halfway up the sides of the bread pan with cooking spray before adding ingredients, to assist in release. Loosen the loaf with a plastic spatula before turning out.

### **Amounts/Sizes/Ingredients**

For white breads and any recipe calling for a white flour (unless it is a quick/batter bread requiring cake flour), the best flour to use is bread flour, which has a higher protein content.

A general formula for a 1½-pound bread machine loaf is: 3 cups bread flour, 1½ – 1¾ cups liquid, 1 teaspoon salt, 1 teaspoon sugar, 1¾ – 2 teaspoons yeast. Use this as your basic formula and make adjustments from there.

In general, a 2-cup flour recipe will produce a loaf that is about 1 pound, a 3-cup flour recipe will produce a loaf that is about 1½ pounds, and a 4-cup flour recipe will produce a loaf that is about 2 pounds. Some recipes will have slightly larger or smaller amounts of flour for each size, and with Mix-ins, they may weigh more than 1 pound, 1½ pounds or 2 pounds.

---

You should not use more than 5 cups flour total in the bread machine.

If you are adapting a recipe, and your mathematical measurements become something odd such as half of an egg, use a small egg as a replacement for half. A large egg is generally equal to about ¼ cup.

It is important to measure ingredients accurately – do not be tempted to omit small amounts such as ½ teaspoon. Baking is chemistry, and changing the formula by even this small amount can change the final product significantly.

A pinch of ginger or a bit of vitamin C can give a boost to the yeast and help it to grow better.

Too much cinnamon or garlic can counteract the rising properties of yeast. Also in this category of “yeast destroyers” are too much citrus zest and alcohol.

Always add nuts at the Mix-in signal. Adding them too early may result in their becoming too finely ground.

## TROUBLESHOOTING

**Dough Does Not Rise Properly** – Check expiration date of yeast. Make certain yeast is fresh and properly stored (sealed, in a cool dark place).

Liquid may have been too hot and killed yeast or liquid may have been too cool and yeast did not activate completely – liquids should be between 75 – 90° for best bread machine results.

Delay Start feature used, but ingredients were in bread pan in improper order. See page 13.

**Short loaves** – Not enough sugar in recipe.

Not enough yeast. Yeast was old or improperly stored.

Delay Start feature used and ingredients not placed in bread pan properly. Salt came into contact with yeast and killed yeast.

Loaves with whole wheat and/or whole grain flours will not be as tall as those made with bread flour.

**Sunken, uneven tops of loaves** – High humidity or high room temperature. Do not place bread machine in sunny window.

On high humidity days, try increasing the flour by one tablespoon per cup of flour used.

**Underbaked, gummy texture** – Dough too wet. When baking next loaf of same bread, watch dough and add flour 1–2 teaspoons at a time.

Too much whole grain or whole grain flour used.

Bread pan too small for recipe.

**Collapsed loaf** – Dough too wet. When baking next loaf of same bread, watch dough and add flour 1–2 teaspoons at a time.

Water not proper temperature.

Ingredients not in proper proportions – be sure to measure dry ingredients correctly by stirring flours first, spooning into measuring cup, then leveling.

**Open texture** – Dough too wet. When baking next loaf of same bread, watch dough and add flour 1–2 teaspoons at a time.

Too much yeast was used.

Salt was omitted or incorrectly under measured.

**Dense, heavy texture** – Dough too dry. When baking next loaf of same bread, watch dough consistency and add water/liquid 1 teaspoon at a time.

This may occur when substituting lowfat products such as fat-free milk or egg replacers, light butter or margarine, fat-free sour cream or cream cheese.

Not enough sugar in recipe.

Not enough yeast used. May need to add dough enhancer or vital gluten flour.

**Kneading paddle embedded in the loaf** – If you are nearby when the signal before last rise sounds, you can remove the kneading paddle, reshape the loaf and replace.

**Small amount of smoke/burning smell from machine** – Most often this is caused by spilled ingredients. If it is bad, unplug machine, clean carefully (**Caution: interior of machine is hot**), then plug machine in again to continue. Program will be stored in memory for a maximum of 15 minutes if unplugged. Otherwise “flour dust” will burn off on its own. Clean completely when machine is unplugged and cool.

---

## ERROR CODES

**HHH or EEE** with continuous beeps:  
Please contact your nearby service center.

**E00 or E01** (with 3 beeps when started):

**E00** indicates ambient temperature is too low (-20°C) to bake bread.

**E01** indicates the temperature of the bread maker is too high to bake bread. This usually occurs when trying to make two successive loaves. The unit should cool from baking cycle before starting to knead a new loaf. Let the unit cool for 10 minutes prior to starting a new loaf.

## BREAD MAKER PANTRY

To be able to prepare breads quickly and easily in your Cuisinart™ Convection Bread Machine, we suggest keeping some basics on hand. Depending on the types of breads you and your family prefer, you may also want to have some of the other items readily available. Not all the ingredients listed are in the recipes, but can be added to improve taste and texture.

**All-Purpose Flour** – Can be bleached or unbleached – we prefer unbleached. For the bread machine, all-purpose flour would be used for the Quick Breads (also referred to as batter breads in some cookbooks). Can also be used to make yeast breads, but bread flour with its higher protein and gluten levels will give you better results.

**Ascorbic Acid (Vitamin C)** – Acts as a preservative, deterring mold and bacteria growth. Adding a little ascorbic acid to Artisan Breads (Doughs) will enable the yeast to work longer, producing a more flavorful, well-textured bread. Professional bakers often add it to French breads, boules, and baguettes when preparing the dough. A crushed (powdered) vitamin C tablet may be used. Use about ¼ teaspoon per 3 cups flour.

**Bread Flour** – An unbleached flour high in protein and gluten. This is the most basic flour for the bread machine and should be used rather than unbleached all-purpose flour for yeast breads.

**Cake Flour** – A very soft flour with low protein. Do not use cake flour for yeast breads unless a recipe specifically requires it. It is most often used to make very tender cakes and pastries.

**Dry Milk** – (fat-free or regular) When loading ingredients add powdered milk along with flour. Using dry milk instead of fresh milk enables you to use the Delay feature. Dry milk is also added to breads (often along with fresh milk/milk products) to increase nutritional value.

**Eggs** – Add taste, richness and color to breads. They act as emulsifiers and aid in keeping breads fresh and moist. Do not ever use with Delay Feature unless using powdered egg or powdered egg white and adding with flour. Egg washes (egg beaten with water or milk) are used with some Dough Only recipes to brush on shaped dough after rising, before baking, to add color and shine to finished baked goods.

**Fats (assorted)** – (unsalted butter, olive oil, vegetable oil) – Add taste, texture and moisture to breads. Most French breads do not have added fats. We suggest using unsalted butter or a good quality olive oil for recipes calling for butter or olive oil.

**Garlic** – In small amounts, garlic aids development of the yeast – but too much garlic will cause the yeast and bread structure to collapse.

**Ginger (powdered)** – Boosts yeast activity and keeps it working longer. Also aids in keeping breads fresh. Use about ¼ teaspoon per 3 cups flour – this small amount will not affect flavor.

**Lecithin** – May be added to bread to maintain freshness and moisture. It also works with gluten to produce a lighter bread. It is derived from either soy or egg yolks and comes in either liquid or granular form.

**Non-Diastatic Malt** – This gives breads better structure, and can make them softer, more tender and give them a longer shelf life. Add ½–1 teaspoon per 3 cups flour. It is a necessary ingredient for making bagel dough.

**Nuts, Seeds, Raisins** – Add flavor, nutrition and texture to breads. May be added to just about any bread recipe where flavors are appropriate.

**Powdered Buttermilk** – A shelf-stable essence of buttermilk without the milk solids. Acts as a preservative and retards the growth of bacteria and mold.

**Salt** – Salt is a necessary part of a yeast bread recipe – it not only adds or enhances flavor, but it controls the yeast and aids in the rising of the dough. Table salt, sea salt or kosher salt can be used. Sea salt and kosher salt

---

are more flavorful, and if a recipe specifies their use, we suggest using the recommended salt.

**Self-Rising Flour** – This flour would not be used in a bread machine. Self-rising flour is an all-purpose flour to which leavener (baking powder) and salt have been added. In traditional baking it is most often used for biscuits, scones, shortcakes, pancakes or waffles.

**Sweeteners** – Granulated sugar, brown sugar, honey, molasses, maple syrup, non-diatstatic malt syrup and golden syrup stimulate yeast growth and development.

**Vital Gluten Flour** – A very high-protein flour made from hard wheat and treated to remove most of the starch. For regular yeast bread baking, vital gluten flour is used primarily as an additive to enhance doughs made with low glens such as rye flour. When making rapid rise breads, add vital gluten flour for a better rise in the shorter rising time. Vital gluten flour is a necessity for the Last-Minute Loaves.

**Whole Wheat Flour** – Contains the wheat germ of the flour, giving it a higher fiber, nutritional, and fat content. Once thought of as “health food” breads that were heavy and dense, breads made with all or part whole wheat flour are the most nutritious and can be light-textured and appealing. Purchase good quality whole wheat flour, and store in refrigerator or freezer to prevent from turning rancid. Bring to room temperature before using for bread machine recipes unless using Delay Feature.

**Yeast** – For most bread machine recipes, we recommend active dry, instant or bread machine yeast. The “Instant” type yeast is milled slightly finer and produced at lower temperatures resulting in fewer “dead” cells. It gives very good results in the bread machine. Rapid rise yeast or quick rise yeast is specifically for the shorter/rapid/last minute cycles, as it helps to shorten the rising cycle – adding vital gluten as well will aid in its rise.

## GLUTEN-FREE INGREDIENTS

To make gluten-free bread, a variety of flours and ingredients is necessary to develop a product that resembles wheat bread in taste and texture for slicing, toasting, and making sandwiches. All of the following ingredients can be found at your local health food store or in a natural foods grocery store.

They are also easily found and ordered on-line. There are also several commercial brands of gluten-free bread mixes which can be used successfully.

**Brown rice flour** – milled from the whole rice kernel, brown rice flour is high in fiber, vitamins and minerals. It is very versatile.

**White rice flour** – milled from polished white rice, white rice flour is also considered a very versatile flour in gluten-free baking because it has a rather mild, undetectable flavor. It also blends well with other flours.

**Garbanzo bean flour** – milled from garbanzo beans and high in protein, garbanzo bean flour imparts a rich and sweet flavor in baked goods when combined with other flours.

**Garfava flour** – milled from both garbanzo and fava beans and high in protein, garfava flour adds the needed protein to gluten-free breads. However, it does have a strong, distinct flavor, so must be combined with other flours in recipes.

**Soy flour** – milled from roasted soybeans and high in quality protein, soy flour has a characteristic nutty flavor. It is recommended to combine soy flour with other flours when baking.

**Buckwheat flour** – Buckwheat is not actually wheat at all. Buckwheat flour does have a high protein content and a nutty, assertive flavor. It should definitely be combined with other flours for baking.

**Rye flour** – Rye flour has a lower gluten (protein) content than its white and wheat counterparts. This means one must use white or wheat flours in combination with rye when baking bread. Combining flours ensures the loaf will rise well.

**Semolina flour** – Semolina is ground from hard wheat. It is pale yellow in color and resembles corn meal. Semolina flour has a very high gluten or protein content. It is used in both making pasta and bread.

**Sorghum flour** – Sorghum is a millet-like grain that is very nutritious. Sorghum flour imparts a faint, sweet flavor to gluten-free products. It needs to be combined with other flours for baking.

**Potato starch** – Great supplementary flour to use in gluten-free baking. Potato starch is also used as a thickener for sauces and soups.

---

**Potato flour** – Heavier than potato starch, potato flour can be used in a similar way but it does carry more of a potato taste.

**Cornstarch** – A good combining ingredient in gluten-free baking – its taste is undetectable.

**Amaranth flour** – High in both protein and fiber, amaranth flour is also a good source of calcium. It has a nutty flavor and combines well with other gluten-free flours.

**Quinoa flour** – Quinoa, considered the most nutritious grain, is high in protein, calcium and iron.

**Xanthan gum** – Used as a thickening agent in gluten-free baking, xanthan gum is used as a binder and to retain moisture. Xanthan gum also adds to the volume of the bread. Can be replaced by guar gum. (Tip: Xanthan gum is also a good and natural way to keep blended vinaigrettes, dressings and marinades emulsified after blending.)

**Gelatin** – Although it is not necessary in gluten-free baking, gelatin adds protein and gives elasticity to bread. (If you are a vegetarian, you may not wish to use gelatin, as it is derived from meat.)

**Tapioca flour** – Grain-free flour that is derived from cassava root. Tapioca flour is starchy and imparts a slightly sweet flavor.

**Cider vinegar** – or dough enhancer (powder containing ascorbic acid) – improves texture of the bread as well as shelf life.

## WARRANTY

### Three-Year Limited Warranty

This warranty supersedes all previous warranties on the Cuisinart™ Convection Bread Maker. This warranty is available to consumers only. You are a consumer if you own a Cuisinart™ Convection Bread Maker that was purchased at retail for personal, family, or household use. Except as otherwise required under applicable state law, this warranty is not available to retailers or other commercial purchasers or owners. We warrant that your Cuisinart™ Convection Bread Maker will be free of defects in material or workmanship under normal home use for three years from the date of original

purchase. We suggest that you complete and return the enclosed product registration card promptly to facilitate verification of the date of original purchase. However, return of this product registration card does not eliminate the need for the consumer to maintain the original proof of purchase in order to obtain the warranty benefits. In the event that you do not have proof of purchase, the purchase date for purposes of this warranty will be the date of manufacture.

If your Cuisinart™ Convection Bread Maker should prove to be defective within the warranty period, we will repair it or, if we think it necessary, replace it. To obtain warranty service, please call our Consumer Service Center toll-free at 1-800-726-0190, or write to:

Cuisinart  
150 Milford Road  
East Windsor, NJ 08520

To facilitate the speed and accuracy of your return, please enclose \$10.00 for shipping and handling of the product. Please also be sure to include a return address, daytime phone number, description of the product defect, product serial number (stamped on bottom of product base), and any other information pertinent to the product's return.

Please pay by check or money order. (California residents need only supply proof of purchase and should call 1-800-720-0190 for shipping instructions).

NOTE: For added protection and secure handling of any Cuisinart® product that is being returned, we recommend you use a traceable, insured delivery service. Cuisinart cannot be held responsible for in-transit damage or for packages that are not delivered to us. Lost and/or damaged products are not covered under warranty.

Your Cuisinart™ Convection Bread Maker has been manufactured to strict specifications and has been designed for use with the Cuisinart™ Convection Bread Maker accessories and replacement parts. These warranties expressly exclude any defects or damages caused by accessories, replacement parts, or repair service other than those that have been authorized by Cuisinart.

These warranties do not cover any damage caused by accident, misuse, shipment, or other than ordinary household use. These warranties exclude

---

all incidental or consequential damages. Some states do not allow the exclusion or limitation of incidental or consequential damages, so the foregoing limitation may not apply to you.

### **California Residents Only**

California law provides that for In-Warranty Service, California residents have the option of returning a nonconforming product (A) to the store where it was purchased or (B) to another retail store which sells Cuisinart brand products of the same type. The retail store shall then, according to its preferences, either repair the product, refer the consumer to an independent repair facility, replace the product, or refund the purchase price less the amount directly attributable to the consumer's prior usage of the product. If either of the above two options does not result in appropriate relief to the consumer, consumer may then take the product to an independent repair facility if service or repair can be economically accomplished.\*

Cuisinart and not the consumer will be responsible for the reasonable cost of such service, repair, replacement, or refund for nonconforming products under warranty.

California residents may also, according to their preference, return nonconforming products directly to Cuisinart for repair or, if necessary, replacement by calling our Consumer Service Center toll-free at 1-800-726-0190. Cuisinart will be responsible for the cost of the repair, replacement, and shipping and handling for such nonconforming products under warranty.

### **Before Returning Your Cuisinart Product**

If you are experiencing problems with your Cuisinart® product, we suggest that you call our Consumer Service Center at 1-800-726-0190 before returning the product for servicing. Often, our Consumer Service Representatives can help solve the problem without having the product serviced. If servicing is needed, a representative can confirm whether the product is under warranty and direct you to the nearest service location.

\*Important: If the nonconforming product is to be serviced by someone other than Cuisinart's Authorized Service Center, please remind the servicer to call our Consumer Service Center at 1-800-726-0190 to ensure that the problem

is properly diagnosed, the product is serviced with the correct parts, and to ensure that the product is still under warranty.

© 2005 Cuisinart  
Cuisinart® is a registered trademark of Cuisinart  
150 Milford Road  
East Windsor, NJ 08520  
Printed in China  
05CU26258

Version no.: <u>CBK200 IB-5859A</u>
Size : <u>229MM(W)X152MM(H)</u> (OLD-SAME AS IB-5859 118PP)
Material: <u>COVER:157GSM MATT ARTPAPER</u> <u>INSERT:120GSM GLOSS ARTPAPER</u>
Binding: <u>WIRE-O BINDING</u>
Coating: <u>VARNISHING IN COVER</u>
Color: <u>COVER:(4C+0C)</u> <u>INSIDE:(1C+1C)</u>
Date: <u>2005-08-04</u>
Hugo Description : <u>IB-5859A(0,1) BOOK</u> OPERATOR:YAN
Hugo code : <u>ELC0303IB-1/7A7</u>

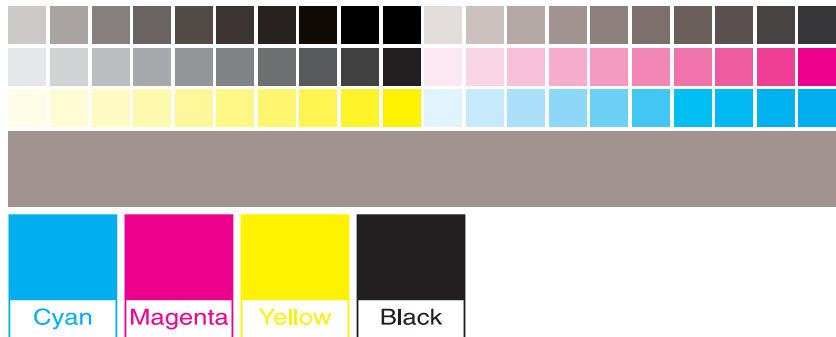

## Free Manuals Download Website

<http://myh66.com>

<http://usermanuals.us>

<http://www.somanuals.com>

<http://www.4manuals.cc>

<http://www.manual-lib.com>

<http://www.404manual.com>

<http://www.luxmanual.com>

<http://aubethermostatmanual.com>

Golf course search by state

<http://golfingnear.com>

Email search by domain

<http://emailbydomain.com>

Auto manuals search

<http://auto.somanuals.com>

TV manuals search

<http://tv.somanuals.com>