

Cuisinart®

INSTRUCTION AND RECIPE BOOKLET



Smart Stick® Hand Blender

CSB-77

For your safety and continued enjoyment of this product,
always read the instruction book carefully before using.

Download from [Www.Somanuals.com](http://www.somanuals.com). All Manuals Search And Download.

IMPORTANT SAFEGUARDS

When using an electrical appliance, basic safety precautions should always be followed including the following:

1. **READ ALL INSTRUCTIONS.**
2. To protect against electrical shock, do not put the motor body, cord or electrical plug of this hand blender in water or other liquid. The detachable blending shaft of this appliance has been designed for immersion into water or other liquids. Never submerge any other portion of this unit. If hand blender falls into liquid, remove immediately. **Do not reach into the liquid without unplugging the unit first.**
3. This appliance should not be used by children. To avoid possible accidental injury, close supervision is necessary when any appliance is used by or near children.
4. **Unplug from outlet when not in use, before putting on or taking off parts, and before cleaning. To unplug, grasp plug and pull from electrical outlet. Never pull cord.**
5. Avoid contacting with moving parts.
6. During operation keep hands, hair, clothing, as well as spatulas and other utensils away from attachments and any mixing container, to reduce risk of injury to persons, and/or damage to the appliance. A spatula may be used, but must be used only when the unit is not operating.
7. Do not operate any appliance with a damaged cord or plug, or after the appliance has malfunctioned or has been dropped or damaged in any way or is not operating properly. Return the appliance to the nearest Cuisinart Repair Center for examination, repair, or mechanical or electrical adjustment.
8. Remove detachable shaft from the blender before washing the blades or shaft.
9. **Blades are SHARP. Handle carefully when removing, inserting or cleaning. Exercise the same care when removing, inserting or reversing the cutting blade for the chopper attachment.**
10. When mixing liquids, especially hot liquids, use a tall container or make small quantities at a time to reduce spillage, splattering and possibility of injury from burning.
11. To reduce the risk of injury, never place chopper/grinder attachment cutting blade on base without first putting prep bowl properly in place.
12. Be certain the chopper/grinder attachment cover is securely locked in place before operating appliance. Do not attempt to remove cover until blade has stopped rotating.
13. Check prep bowl for presence of foreign objects before using.
14. The use of attachments or accessories not recommended by Cuisinart may cause fire, electrical shock, or risk of injury.

15. Do not use outdoors, or use for other than intended use.
16. Do not let any cord hang over the edge of the table or counter. Do not let cord contact hot surfaces, including stovetop.
17. Make sure the appliance is off, the motor has stopped completely, and the appliance is unplugged from outlet before putting on or taking off attachments, and before cleaning.
18. To reduce the risk of fire or electrical shock, do not operate any heating appliance beneath the mounting unit.
19. Maximum rating of 200W is based on the chopper/grinder attachment that draws the greatest power.
20. Do not operate your appliance in an appliance garage or under a wall cabinet. **When storing in an appliance garage always unplug the unit from the electrical outlet.** Not doing so could create a risk of fire, especially if the appliance touches the walls of the garage or the door touches the unit as it closes.

SAVE THESE INSTRUCTIONS FOR HOUSEHOLD USE ONLY

NOTICE

This appliance has a polarized plug (one blade is wider than the other). As a safety feature, this plug will fit in a polarized outlet only one way. If the plug does not fit fully in the outlet, reverse the plug. If it still does not fit, contact a qualified electrician. Do not attempt to defeat this safety feature.

CONTENTS

Important Safeguards	2
Unpacking Instructions	4
Features and Benefits	4
Whisk Tips	5
Diagram	6
Assembly	7
Blending Attachment	7
Chopper/Grinder Attachment	7
Reversible Blade	8
Whisk Attachment	10
Operation	11
Blending & Mixing	11
Whisking	11
Chopping/Grinding	12
Cleaning and Maintenance	12
Tips and Hints	14
Frequent Uses for Chopper/Grinder Chart	15
Recipes	16
Warranty	28

UNPACKING INSTRUCTIONS

Place the package containing the Cuisinart® Smart Stick® Hand Blender on a sturdy surface. Unpack the Smart Stick® Hand Blender from its box by removing the upper protective insert. Gently slide the unit from the box. Remove all support materials from the box and replace the upper insert. Save packaging for possible repacking of the unit.

Note: The blending blade is extremely sharp. Use caution when removing and unpacking the storage stand.

Before using the Cuisinart® Smart Stick® Hand Blender for the first time, we recommend that you wipe the unit with a clean, damp cloth to remove any dirt or dust. Dry it thoroughly with a soft absorbent cloth. Handle carefully; wash each individual blade assembly, mixing container and detachable shaft by hand or in the dishwasher. Dry thoroughly before use. Read all instructions completely for detailed operating procedures.

FEATURES AND BENEFITS

1. **One-Touch On/Off Button:** Allows you to activate the hand blender at the touch of a button. Simply press and hold down on the toggle switch to blend or pulse. Once the button is released, blending will stop.
2. **Comfort Handle:** The handle allows you to control the hand blender with ease.
3. **Motor Body Housing**
4. **Detachable Shaft:** Pressing the release button on the back of the unit will detach the shaft for easy cleaning.
5. **Blending Attachment with Stainless Steel Blade and Blade Guard:** This attachment easily snaps into the motor body housing. The permanently mounted stainless blade is partially covered by a stainless housing that keeps splashing to a minimum.
6. **Whisk Attachment:** Whisk attachment snaps into the motor body housing. This attachment is great for whipping cream, egg whites and other delectable treats.
7. **Chopper/Grinder Attachment with reversible blade:** Chop, mince and grind with the Cuisinart® Chopper/Grinder attachment. Chopper/Grinder attaches to the blender motor body in place of the blender shaft or whisk attachment.
8. **Mixing Beaker:** 2-cup mixing beaker is microwave - and dishwasher safe. Use this container to blend drinks, shakes, salad dressings and more. Designed for easy gripping and drip-free pouring.

WHISK TIPS

Use the whisk attachment for beating heavy cream or egg whites. It may also be used for whisking eggs for scrambled eggs or fluffy omelets.

BEATING EGG WHITES

When beating egg whites use a very clean metal or glass bowl, never plastic. Plastic can contain hidden oils and fats that can ruin the delicate egg white foam. To help stabilize the egg whites add 1/8 teaspoon of cream of tartar per egg white prior to beating them. (If using a copper bowl omit the cream of tartar.) Beat the egg whites until soft peaks form that do not droop. Beating the egg whites longer causes them to dry out and become even less stable. When adding sugar to beaten egg whites add it slowly when soft peaks just begin to form and then continue beating to form soft peaks that don't droop.

BEATING HEAVY CREAM

When beating heavy cream, if possible and if time allows, use a chilled bowl, and chill the whisk attachment. The best shaped bowl for whipping cream is one that is deep with a rounded bottom. The cream should come out of the refrigerator just before whipping. Hold the whisk attachment so that it is just skimming the surface, and whip until the cream begins to thicken and develop some body; then immerse the whisk totally into the cream. Whipped cream may be used at either soft or firm peaks depending on preference. It may be flavored as desired. For best results, whip cream just before using.

If it must be whipped ahead, add a whipped cream stabilizer such as Oetker® Whip It™.

Oetker® is a registered trademark owned by Dr. August Oetker Nahrungsmittel, KG, LP.

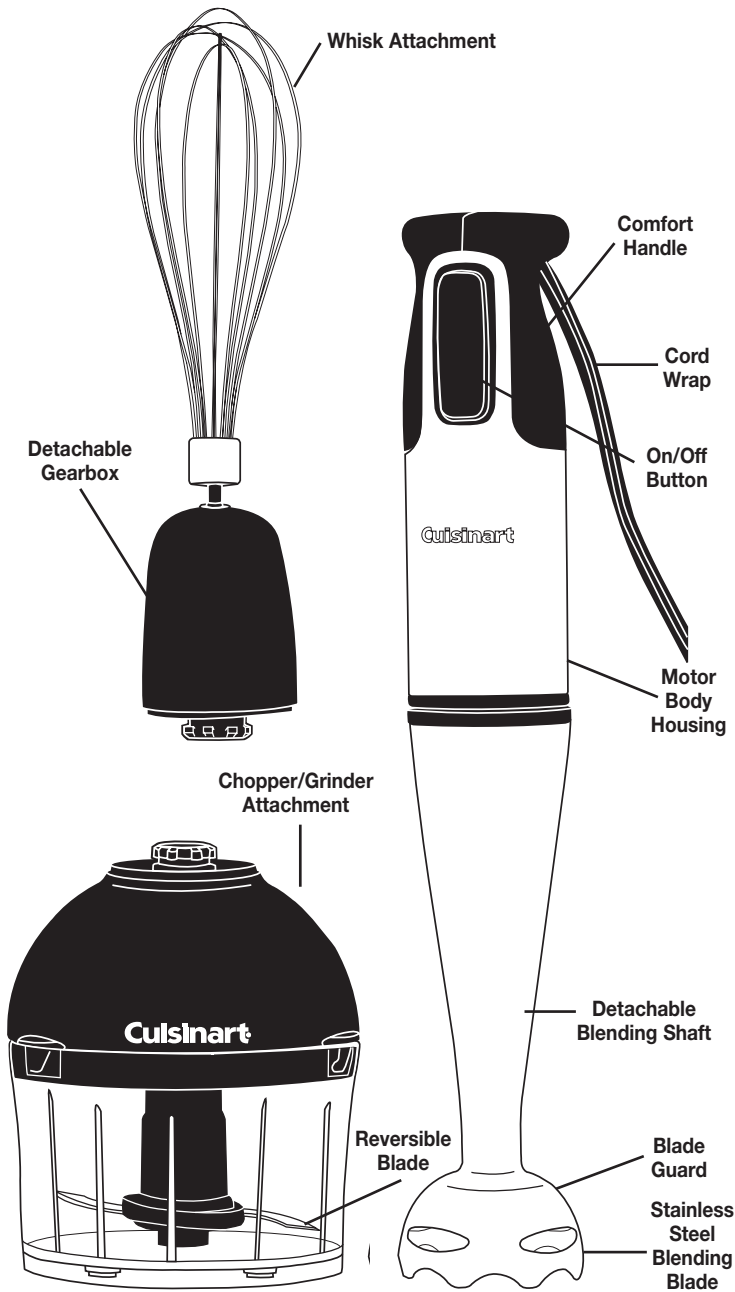

ASSEMBLY

BLENDING ATTACHMENT

1. Align the motor body with the blending attachment and slide the pieces together until you hear and feel the pieces click together. It may be helpful to press the release button when assembling.



CHOPPER/GRINDER ATTACHMENT

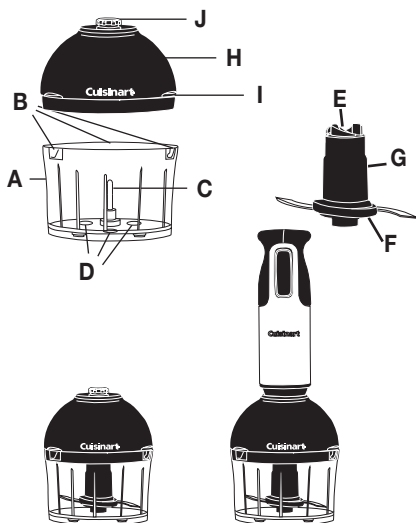

- A. Chopper/Grinder Prep Bowl
- B. Cover Slots (3) for Attaching Cover
- C. Metal Blade Assembly Shaft
- D. Rubber Feet
- E. Blade Assembly
- F. Blade Ring with Reversible Blade
- G. Plastic Blade Sheath
- H. Chopper/Grinder Cover
- I. Lift Tabs
- J. Chopper/Grinder Spline

REVERSIBLE BLADE

The Cuisinart® Smart Stick® Hand Blender chopper/grinder attachment is equipped with a reversible blade. This blade is sharp on one side and blunt on the other. The blade is attached to a plastic ring which slides over the plastic blade sheath, so it can be easily turned over to select the appropriate blade. To reverse the blade: see detailed instructions below. Frequent Uses for Chopper/Grinder (page 15).

Before you process any food, assemble the blender parts.

1. Put the prep bowl on a flat, dry, stable surface. It should be close to an electrical outlet of the same voltage as stated on the rating plate on the Smart Stick® Hand Blender.
2. The metal blade assembly shaft (C) is attached to the bottom of the prep bowl. If not already in place, slide the fully assembled blade assembly (E) over the top of the metal blade assembly shaft.

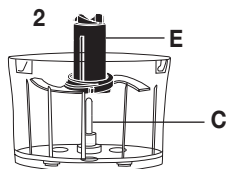

- 2a. Putting together the blade assembly: Connect the blade ring (F) to the plastic blade sheath (G). Line up the blade ring opening with the plastic sheath. Let the blade ring slide to the bottom of the plastic sheath. **HOLD THE BLADE RING BY THE CENTRAL HUB HOLDING RIBS (grips) (K) ONLY. DO NOT TOUCH THE RAZOR-SHARP BLADES.**

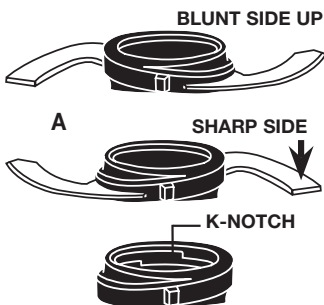

Note these important features of the blade ring. The blade ring can be placed over the plastic blade sheath in two different ways:

If you hold it this way (A), you will see the word “Sharp” on the blade. Assemble the blade this side up to use the sharp edge. (See the section on processing food for information about when to use the sharp edge.)

If you hold it this way (B), you will see no writing on the blade. Assemble the blade this side up to use the blunt edge. (See the section on processing food, for information about when to use the blunt edge.)

There are notches (C) on opposite sides of the interior of the hub. These fit over ridges on the sides of the plastic blade sheath.

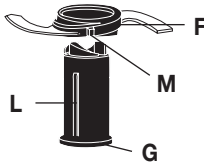

Pick up the blade ring by its hub holding ribs (grips) and turn it very slightly clockwise. This locks it in place on the plastic blade sheath and prevents it from sliding up during processing.

3. Connect the Smart Stick® Hand Blender motor body to the top of the chopper/grinder attachment cover. Align the spline in the chopper/grinder cover's drive shaft with the ribbed opening on the underside of the motor body. When aligned properly, slide the two pieces together until they mate. You will feel and hear a slight click. It may be helpful to press the rubber release button when sliding these pieces together.

4. With the hand blender in place, locate the chopper/grinder cover and put it on top of the prep bowl.

- 4a. Be sure that the 3 ridges (cover slots) at the top of the prep bowl line up with the 3- knotches in the underside of the chopper/grinder cover, and that the cover is seated all around the top of the prep bowl.

- 4b. Rotate cover clockwise to secure it to the prep bowl.

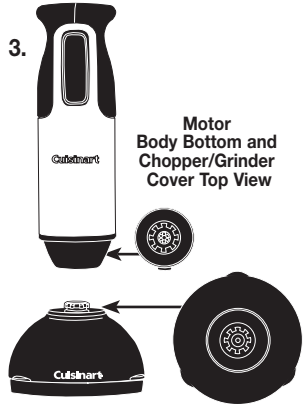

4a.

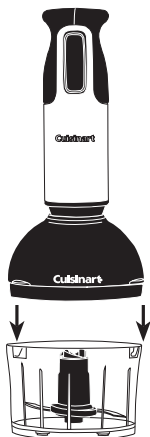

4b.

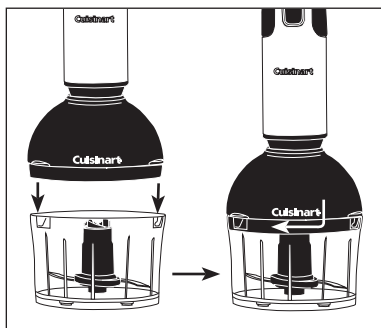

5. Plug the power cord of the Smart Stick® Hand Blender into an electrical outlet.
6. Put one hand on the cover of the chopper/grinder attachment, while gripping the Smart Stick® Hand Blender motor body handle with the other. Press the High or Low button with your fingers to start the motor and run the chopper/grinder.
To turn the unit off, remove your fingers from the selected button.
7. WHEN THE BLADE STOPS MOVING, unplug the Smart Stick® Hand Blender, remove the motor body from the chopper/grinder cover, and remove the cover from the prep bowl.

WHISK ATTACHMENT

1. Align the end of the whisk (A) with the small opening of the whisk gearbox (B).
2. Push end into opening until it locks into position (C).
3. Align the motor body with the assembled whisk attachment and slide the pieces together until you hear and feel the pieces click together. It may be helpful to press the release button when assembling.



OPERATION

BLENDING & MIXING

The specially designed blade is for mixing and stirring all kinds of foods, including salad dressings, powdered drink products, and sauces. It is ideal for combining dry ingredients, and can be used to emulsify mayonnaise, too.

This blade mixes and stirs while adding only a minimum of air to your mixture. A gentle up-and-down motion is all you need to make the most flavorful, full-bodied liquid recipes. Be careful never to remove the Cuisinart® Smart Stick® Hand Blender from the liquid while in operation.

1. Insert the blending attachment into the motor body.
(See Assembly for Blending Attachment, page 7.)
2. Plug electrical cord into an electrical wall socket.
3. Insert blending shaft into mixture to be blended.
4. Press and hold the ON/OFF button. The hand blender will continue to run as long as the switch is pressed in. To turn hand blender OFF, release the ON/OFF button and the motor will stop.
5. Do not hold the button ON for longer than 50 seconds at a time.
6. Unplug immediately after use.

WHISKING

1. Insert the whisk attachment into the motor body. (See Assembly for Whisk Attachment, page 10.)
2. Plug electrical cord into an electrical wall socket.
3. Insert the whisk into mixture to be blended.
4. Press and hold the ON/OFF button. The hand blender will continue to run as long as the switch is pressed in. To turn hand blender OFF, release the ON/OFF button and the motor will stop.
5. Do not hold the button ON for longer than 20 seconds at a time.
See Recipes.
6. Unplug immediately after use.

CHOPPING AND GRINDING

Processing Food

1. Put the prep bowl firmly on a flat sturdy surface like a countertop. Be sure the blade is assembled to use the blade edge that is appropriate for the food to be processed.
2. Put food into the prep bowl. Be sure the food is cut into small pieces, and the bowl is not overloaded.
3. Put the chopper/grinder cover on top of the prep bowl. Be sure the cover is properly seated.
4. Press the ON/OFF button on the Smart Stick® Hand Blender.
5. Do not operate the chopper/grinder attachment for longer than 15 seconds at a time.

Note: Due to the powerful motor provided with this unit, Cuisinart recommends using one hand to support the chopper/grinder during operation.

6. When you have finished processing the food, stop the machine by taking your fingers off the ON/OFF button.
7. WHEN THE BLADE STOPS MOVING, remove the Smart Stick® Hand Blender motor body from the chopper/grinder cover, and remove the cover from the chopper/grinder.
8. Unplug the unit.
9. Carefully remove the blade assembly, holding it by the gripping ridges on the plastic sheath. NEVER TOUCH THE BLADE ITSELF.
10. Remove food with the spatula.

Note: Do not operate the Smart Stick® Chopper/Grinder attachment without food in the prep bowl.

CLEANING AND MAINTENANCE

SMART STICK® HAND BLENDER

Always clean the Smart Stick® motor body and blending shaft thoroughly after using.

Remove the blending shaft from the motor body. Clean the motor body only with a sponge or damp cloth. Do not use abrasive cleaners which could scratch the surface. To clean the blending shaft, wash by hand in hot water using mild detergent. Be mindful of the permanently mounted razor sharp edges.

Never immerse the motor body in water.

When the appliance has malfunctioned or has been dropped or damaged in any way or is not operating properly, return the appliance to the nearest Cuisinart Repair Center for examination, repair or mechanical or electrical adjustment.

Any other servicing should be performed by an authorized service representative.

CHOPPER/GRINDER ATTACHMENT

To simplify cleaning, rinse the prep bowl, cover, and blade immediately after use, so that food won't dry onto them. Wash blade ring, plastic sheath, and prep bowl in warm soapy water. Rinse and dry. Wipe the underside of the chopper/grinder cover with a sponge or damp cloth to remove any food. **Do not submerge the cover in water or put in the dishwasher.** Wash the blade carefully. Avoid leaving it in soapy water where it could disappear from sight.

If you have a dishwasher, you can wash the prep bowl blade assembly on the upper shelf. Insert the prep bowl upside down. Put the blade in the cutlery basket. Unload the dishwasher carefully to avoid contact with the sharp blade. Wipe the motor body and top of the cover with a damp sponge or cloth. Dry it immediately. **Never submerge the motor body or the cover in water or other liquid.**

The Smart Stick® chopper/grinder attachment is intended for HOUSEHOLD USE ONLY. Any service, other than cleaning and normal user maintenance, should be performed by an authorized Cuisinart Service Representative.

WHISK ATTACHMENT

To clean your whisk attachment, simply release the attachment from the motor body housing. Once the whisk is removed, detach the metal whisk from the gearbox by pulling pieces apart.

To clean the gearbox, simply wipe with a damp cloth.

To clean the metal whisk, wash with warm, soapy water or in the dishwasher.

Do not submerge the gearbox in water or any other liquid.

TIPS AND HINTS

1. Liquid should come within an inch of where the shaft attaches to the motor housing.
2. Some spices may scratch the chopper/grinder attachment.
3. When using with a nonstick cooking surface, be careful not to scratch the coating with the hand blender.
4. Do not immerse motor body housing, chopper/grinder cover, or whisk gearbox in water or any other liquid.
5. Cut most solid foods into ½-inch cubes for easy blending. Suggestion: use chopper/grinder for chopping and grinding solid foods.
6. Pour liquid ingredients into the mixing container first, unless recipe instructs otherwise.
7. To avoid splashing, don't turn the hand blender on until the blade is beneath the surface of the mixture and do not pull the hand blender out of the mixture while blender is running.
8. Do not let hand blender stand in a hot pot on stove while not in use.
9. Do not put fruit pits, bones, or other hard material into the blending mixture, as these are liable to damage the blades.
10. Do not fill mixing containers too full. The level of mixture will rise when blending, and can overflow.
11. Adding liquids that are warm, not cold, facilitates blending solids with liquids.
12. For recipes calling for ice, use crushed ice (not whole cubes) for best results.
13. Using a gentle up-and-down motion is the best way to blend and incorporate ingredients uniformly.
14. To avoid spatter, turn the hand blender off and let the blade stop completely before lifting the unit out of the mixture you are processing.
15. To whip air into a mixture, always hold the blade just under the surface.
16. To make a soup creamy in texture, use the hand blender to purée the soup solids to the desired consistency using a gentle up-and-down motion right in the saucepan. You can quickly change your soup into a thick and creamy blend.
17. If you are making a dip or spread, it is not necessary to process completely into a smooth purée; leave some texture for interest.
18. When making compound butters, remove the butter from the refrigerator and let it come to room temperature before blending in the ingredients.

FREQUENT USES FOR CHOPPER/GRINDER

Ingredient	Suggested Blade	Comments
Baby foods (always consult a pediatrician or family physician for appropriate food recommendations)	Sharp Blade	Place small amounts of cooked foods into chopper/grinder bowl. Add small amount of appropriate liquid. Pulse to chop, then hold to blend
Bread Crumbs - fresh or dry (day old)	Sharp Blade	Pulse to chop, then process until desired consistency is reached
Hard Cheese (Asiago, Locatelli, Parmesan, Romano, etc.) (Not recommended for softer cheeses unless making a dip or dressing)	Dull Blade	Cut into .25 inch pieces. Pulse to chop then process until desired consistency is reached
Chocolate	Dull Blade	Cut into .5 inch pieces; may chill in freezer for 3 minutes before chopping. Pulse to chop, then process, no more than 1 ounce at a time, until desired texture is reached.
Creamy Dressing and Dips	Sharp Blade	Place ingredients in chopper/grinder bowl; do not cover or spill on stem. Use pulse action to chop, then continuous - hold action to blend to desired consistency.
Garlic	Sharp Blade	Peel up to six cloves. Pulse to chop
Root Ginger (fresh)	Sharp Blade	Peel, cut into .5 inch pieces. Pulse to chop .5 ounce at a time
General Spices (dill, poppy, star anise, etc.)	Dull Blade	Pulse to chop until desired consistency. Pulse with sharp blade to get a fine chop
Herbs (fresh)	Sharp Blade	.5 cup; must be clean/dry. Pulse to chop
Nuts	Dull Blade	Shelled, toast first for best flavor. Pulse to chop, process up to .5 cup at a time, until desired consistency is reached. May be processed to nut-butter stage.
Onion	Sharp Blade	Peel, cut into 1/2 inch pieces. Pulse to chop, up to 1/2 cup at a time, until desired chop is reached.
Vegetables (cooked)	Sharp Blade	Cut into .5 inch pieces; pulse to chop, up to 1/2 cup at a time. Add cooking liquid, stock or milk to process to a puree. It is not recommended for making mashed potatoes.
Vegetables (uncooked)	Sharp Blade	Peel as needed, cut into 1/2 inch pieces. Peel celery with peeler to remove tough strings. Chop/process up to a 1/2 cup at a time.
Meat	Sharp Blade	6 oz. or 175g, cut into .5 inch pieces
Simple Blending	Dull Blade	

SMOOTHIES AND DRINKS

Blueberry Banana Anti-Oxidant Smoothie

Makes 2 cups

- ¾ cup soy milk or fat-free milk**
- 14 grams soy protein powder (or soy protein isolate)**
- 1 cup frozen blueberries**
- 1 small (4½ ounces) banana, sliced**
- 1 teaspoon flaxseed oil**
- 1–2 teaspoons honey (optional)**

Put soy milk, protein powder, blueberries, banana, flaxseed oil and honey if using into mixing bowl. Insert the hand blender, making sure the protective guard is submerged. Blend, using a gentle up-and-down motion until ingredients are combined, about 35 seconds.

Nutritional information per cup (made without honey):
Calories 159 (17% from fat) • carb. 26g • pro. 9g • fat 3g
• sat. fat 0g • chol. 0mg • sod. 12mg • calc. 89mg • fiber 4g

Strawberry Kiwi Smoothie

Makes one 14-ounce smoothie

- 1 cup frozen strawberries, partly thawed**
- 1 kiwi, peeled, cut into eighths**
- ½ cup fat-free vanilla yogurt**
- ½ cup fat-free milk**
- 1 tablespoon honey**

Put ingredients into mixing bowl. Insert the blender, making sure the protective guard is submerged. Blend, using a gentle up-and-down motion until ingredients are well combined, about 30–35 seconds.

Nutritional information per smoothie:
Calories 286 (2% from fat) • carb. 63g • pro. 11g • fat 1g
• sat. fat 0g • chol. 4mg • sod. 133mg • calc. 371mg • fiber 6g

Frozen Coffee Frappé

Makes one 12-ounce shake

- 1¾ cups coffee ice cream or ice milk**
- ½ cup strong brewed coffee (may use espresso)**
- 2 tablespoons fat-free milk**

Put ingredients into mixing bowl. Insert blender, making sure the protective guard is submerged. Blend, using an up-and-down motion until ingredients are well combined, about 20–30 seconds.

For a thicker style milkshake:

In mixing bowl put 1 cup coffee ice cream. Add ¼ cup brewed coffee and 1 tablespoon of fat-free milk. Blend using the same technique as above.

For a Mudslide variation:

Add 1 tablespoon each of Irish Cream liqueur and Kahlúa®.

Nutritional information per shake:

*Calories 215 (44% from fat) • carb. 26g • pro. 5g • fat 11g
• sat. fat 7g • chol. 45mg • sod. 105mg • calc. 172mg • fiber 0g*

Kahlúa® is a registered trademark owned by the Kahlua Company.

Peach Margarita

Makes 2 cups

- 1 cup frozen peaches**
- 1 cup citrus juice (orange, lime, lemon in any combination)**
- ⅓ cup good quality tequila**
- ½ tablespoon Triple Sec or Grand Marnier®**
- 1–2 teaspoons granulated sugar**

Put ingredients into mixing bowl. Insert the blender, making sure the protective guard is submerged. Blend, using an up-and-down motion until ingredients are combined, about 30 seconds.

Nutritional information per cup:

*Calories 177 (0% from fat) • carb. 25g • pro. 1g • fat 0g
• sat. fat 0mg • chol. 0mg • sod. 2mg • calc. 9mg • fiber 2g*

Grand Marnier® is a registered trademark owned by the Société des Produits Marnier-LaPostolle.

Mexican Hot Chocolate

We made our hot chocolate with fat-free milk and it was a big hit.
For a richer chocolate, make it with whole or reduced-fat milk.
Now and then indulgence is good for the soul.

Makes 12 to 16 servings

- 2 quarts fat-free milk**
- 3-inch cinnamon sticks**
- 20 ounces bittersweet chocolate (your favorite),
broken into chunks**
- 1 tablespoon pure vanilla extract**

Combine the milk and cinnamon sticks in a 3¾ quart Cuisinart® saucepan. Cook over medium heat, stirring constantly to heat until steamy and just beginning to bubble around the edges. Reduce heat to low and simmer for 10 minutes to infuse the cinnamon flavor into the milk. Stir in the chocolate chunks. When chocolate has melted, remove cinnamon sticks and stir in vanilla. Insert the blender and process about 1 minute using a gentle up-and-down motion. Continue blending until the mixture is creamy and frothy. Spoon into cups or mugs and top with a dollop of freshly whipped cream if desired.

For Hot Cinnamon Mocha, add 3–4 tablespoons instant espresso powder to the milk when steeping with the cinnamon sticks.

Nutritional information per serving:

*Calories 215 (52% from fat) • carb. 23g • pro. 7g • fat 14g
• sat. fat 8g • chol. 2mg • sod. 68mg • calc. 184mg • fiber 1g*

SOUPS, SAUCES, DIPS AND SPREADS

Asparagus Soup

Makes 2½ cups

- 2 ounces shallot, peeled**
- 1 tablespoon unsalted butter**
- 1 garlic clove, peeled and crushed**
- 1½ pounds fresh asparagus, tough ends removed**
- 3 ounces red potato, peeled, cut into ½-inch dice**
- ¼ cup dry white wine**
- 1½ cups fat-free low-sodium chicken broth**
- ¾ teaspoon kosher salt**
- ¼ teaspoon freshly ground pepper**
- ¼ teaspoon dried basil**
- ¼ cup heavy cream (optional)**

Insert the blade assembly, sharp side up in the prep bowl. Put the shallot into the prep bowl, insert the blender, making sure the protective guard is submerged. Pulse 10 times to finely chop.

Melt butter in a 3-quart saucepan over medium low heat. Sweat the shallots and crushed garlic over medium-low heat for about 5 minutes. Do not allow the shallots and garlic to brown.

While shallots are cooking, cut the asparagus into ½-inch pieces and reserve the tips. When shallots are soft, add asparagus and potato to saucepan and cook for about 6 minutes longer, until asparagus is bright in color. Add wine and raise the heat to bring the wine to a boil. Reduce the wine until a scant tablespoon remains. Add chicken stock. Bring to a boil and then reduce heat to low. Simmer for about 20 minutes until the vegetables are soft. Insert the blender into the saucepan, making sure the protective guard is submerged. Blend, using a gentle up-and-down motion until ingredients are well combined, about 40 - 50 seconds. Season with salt, pepper and basil. Stir in cream if using.

While soup is cooking bring 2 cups of water to a boil. Add the asparagus tips and cook for 2 minutes until bright green. Drain and immediately plunge into an ice-water bath to stop cooking.

Serve soup hot, garnished with reserved asparagus tips.

Nutritional information per ½ - cup serving:

*Calories 81 (28% from fat) • carb. 10g • pro. 4g • fat 3g
• sat. fat 1g • chol. 6mg • sod. 525mg • calc. 36mg • fiber 2g*

Curried Cauliflower Soup

Makes 5 cups

- 1** **tablespoon olive oil**
- 4** **ounces leeks, washed and trimmed, dark green parts removed, sliced**
- 1** **teaspoon curry powder**
- ¼** **teaspoon turmeric**
- ½** **teaspoon kosher salt**
- 1** **head of cauliflower (about 1¾ pounds) cut into small florets**
- 3½** **ounces red potato, peeled, cut into ½-inch cubes**
- ½** **cup white wine**
- 3½** **cups chicken stock or vegetable stock**
- 1** **teaspoon lemon or lime juice**

Put a 4-quart saucepan over medium heat and add olive oil. Sweat leeks for about 6–8 minutes until very soft. Add curry powder, turmeric, and salt to leek mixture and cook for about 1–2 minutes. Add cauliflower florets and potato. Stir to coat with spices and cook for another 5 minutes to soften slightly. Add white wine and increase heat to bring to a boil. Reduce the wine until there is a scant amount left. Add stock just to cover. Bring to a boil and then reduce heat to medium low. Simmer for about 25 minutes or until the vegetables are very soft.

Insert the hand blender into the saucepan, making sure the protective guard is submerged. Blend, using an up-and-down motion until ingredients are well combined, about 45–50 seconds. Add lemon juice. Taste and adjust seasoning accordingly.

Nutritional information per ½ - cup serving:
Calories 71 (22% from fat) • carb. 10g • pro. 4g • fat 2g
• sat. fat 0g • chol. 0mg • sod. 350mg • calc. 39mg • fiber 3g

Sweet Red Pepper Coulis

This multipurpose sauce is great for chicken, fish, crab cakes, and pastas.

Makes 2½ cups

- 1** **tablespoon olive oil**
- 1** **medium yellow onion, peeled, roughly chopped**
- 6** **garlic cloves, peeled and smashed**
- 3** **medium red peppers (about 6 ounces each), roughly chopped**
- ½** **teaspoon kosher salt**
- ¼** **teaspoon freshly ground pepper**
- ¼** **cup dry white wine**
- ¼** **cup chicken stock**

Heat the olive oil in a 2½-quart saucepan over medium-low heat. Add the onion, garlic, red peppers, salt, and pepper and stir to coat. Reduce heat to low, cover loosely and sweat vegetables slowly until softened, about 15–20 minutes. Take care that the vegetables do not pick up any color.

When vegetables are soft, add wine and increase the temperature so that the wine comes to a boil. Reduce the wine until about 1 tablespoon remains. Add stock and bring to a boil. Reduce heat to medium low and simmer for about 10 minutes. Insert the blender into the saucepan, making sure the protective guard is submerged. Blend, using an up-and-down motion until ingredients are smooth and well combined, about 50 - 60 seconds.

Nutritional information per ½ - cup serving:
Calories 41 (33% from fat) • carb. 5g • pro. 1g • fat 2g
• sat. fat 0g • chol. 0mg • sod. 148mg • calc. 13mg • fiber 1g

Green Chile Sauce

This sauce is excellent served with your favorite Mexican dish—or use it as a base for a delicious southwestern stew.

Makes 2¼ cups

- 1½** **pounds Anaheim or green New Mexican chiles**
- 1** **small onion (approximately 3¼ ounces), cut into quarters**
- 1** **large garlic clove, peeled**
- 1** **jalapeño pepper (approximately ½ ounces), cut in half, seeds and stem removed**
- 1** **tablespoon unsalted butter**
- 1** **tablespoon flour**
- 1½** **cups chicken stock**
- ¾** **teaspoon kosher salt**

Preheat oven to 450°F. Put peppers on a baking sheet and roast until very dark and skin is coming away from the pepper, about 30 minutes. Put roasted peppers into a mixing bowl and cover with plastic wrap in order for the skins to loosen, about 15 minutes.

Insert the blade assembly in the prep bowl. Put the onion, garlic, and jalapeño into the prep bowl and pulse approximately 8 times to a rough chop.

Peel the cooled peppers, discarding all skin, seeds, and stems. Place in prep bowl and pulse 6 times to chop.

Place a 3½ - quart sauté pan over medium heat and add the butter. Add the onion, garlic and jalapeño mixture and sauté for about 4–5 minutes and soft. Stir in chopped chiles and cook for another minute. Add flour and stir and cook for 2 minutes. Add stock and bring to a boil. Add salt and reduce to a simmer for about 25 minutes. Insert the blender into the saucepan, making sure the protective guard is submerged. Blend, using an up-and-down motion until ingredients are well combined, about 40–60 seconds, until the sauce reaches desired consistency.

Nutritional information per ¼ - cup serving:

Calories 39 (35% from fat) • carb. 5g • pro. 1g • fat 2g

• sat. fat 1g • chol. 3mg • sod. 476mg • calc. 59mg • Fiber 1g

Garden Vegetable Tomato Sauce

A fresh and healthy pasta sauce that is excellent served with whole-wheat pasta and topped with crumbled feta cheese.

Makes 4 cups

- 1** **tablespoon olive oil**
- 4** **ounces yellow onion, cut into quarters**
- 2** **garlic cloves, peeled and crushed**
- 3½** **ounces red pepper, cut into 1-inch pieces**
- 3** **ounces eggplant, peeled and cut into 1-inch pieces**
- 3** **ounces zucchini, cut into 1-inch pieces**
- 3** **ounces summer squash, cut into 1-inch pieces**
- 1** **small carrot, peeled and cut into ½-inch pieces**
- ¼** **cup dry white wine**
- 1** **sprig fresh thyme**
- ¾** **teaspoon salt**
- 1** **can (28 ounces) diced tomatoes**

Insert the blade assembly in the prep bowl. Put the onion into the prep bowl and pulse approximately 8 times to a rough chop.

Heat the olive oil in a 3-quart saucepan over medium heat. Add the chopped onion and the crushed garlic to the pan and reduce heat to low. One at a time, put the remaining vegetables into the prep bowl and chop with 8 even pulses and then add to the pan, stirring between each addition. After carrot is added, stir and allow vegetables to cook over low heat for about 15 minutes.

Add white wine and reduce wine to 1 tablespoon. Add thyme, salt, and tomatoes. Simmer for 25 minutes longer.

Insert the blender into the saucepan, making sure the protective guard is submerged. Blend, using an up-and-down motion until ingredients are well combined, about 50–60 seconds.

Nutritional information per ¼ - cup serving:

*Calories 60 (25% from fat) • carb. 9g • pro. 2g • fat 2g
• sat. fat 0g • chol. 0mg • sod. 351mg • calc. 29mg • fiber 3g*

Basic Vinaigrette

Use this basic vinaigrette as a guide and change your vinegar/oil flavors to come up with appropriate combinations to create exciting salads. You may add other flavors such as crushed or roasted garlic, chopped shallots, fresh or dried herbs, sun-dried tomatoes, honey, lemon juice, or flavored vinegars.

Makes 1 cup

¼ cup wine vinegar
1 tablespoon Dijon mustard
¾ cup salad or olive oil
kosher salt and freshly ground pepper to taste

Put all ingredients into a mixing bowl. Process until combined, about 10–15 seconds. Keep unused portions in an airtight container in the refrigerator up to 2 weeks.

Nutritional analysis per tablespoon:

*Calories 91 (98% from fat) • carb. 0g • pro. 0g • fat 10g
• sat. fat 1g • chol. 0mg • sod. 23mg • calc. 0mg • fiber 0g*

Creamy Parmesan & Roasted Garlic Dressing

Similar to a Caesar dressing, but made with roasted garlic to give the dressing a more mellow flavor.

Makes about 1½ cups

1 ounce Parmigiano-Reggiano cheese, cut into ½ -inch cubes
4 garlic clove roasted*
2 tablespoons fresh lemon juice
2 tablespoons red or white wine vinegar
2 tablespoons lowfat mayonnaise or pasteurized liquid egg product (such as EggBeaters®)
1 tablespoon Dijon mustard
1 tablespoon anchovy paste
1 teaspoon Worcestershire sauce
1 teaspoon freshly ground pepper
1 cup extra virgin olive oil
Tabasco® or other hot sauce (to taste)

Insert the blade assembly in the prep bowl. Put the cheese cubes into the prep bowl. Pulse to chop, 10 times, then process to chop finely, about 15–20 seconds. Add remaining ingredients to prep bowl. Process for about 30–40 seconds, until creamy and totally emulsified.

Nutritional analysis per tablespoon:

*Calories 53 (89% from fat) • carb. 1g • pro. 1g • fat 5g
• sat. fat 1g • chol. 4mg • sod. 82mg • calc. 18mg • fiber 0g*

*To roast garlic: Put 12 or more peeled cloves into a double thickness of aluminum foil, toss with a tablespoon of olive oil and fold the foil to seal. Roast in a 375°F oven for 30–40 minutes, until tender and browned. If you do not wish to roast the garlic, you may blanch it until tender.

Egg Beaters® is a registered trademark owned by Nabisco Inc.

Mayonnaise

Make quick mayonnaise in just moments.

Makes about 1¼ cups

- ¼ cup pasteurized liquid egg product (such as EggBeaters®)**
- 1 tablespoon fresh lemon juice**
- ½ tablespoon Dijon mustard**
- 1 cup vegetable oil**
- ¼ teaspoon kosher salt**
- ¼ teaspoon ground white pepper**

Put all ingredients in to a mixing bowl in order listed. Insert blender holding blade against bottom of container and process until mixture begins to thicken, about 15 seconds. Continue processing with a gentle up-and-down motion until thick, about 20–30 seconds longer.

Nutritional information per tablespoon:

*Calories 98 (98% from fat) • carb. 0g • pro. 0g • fat 11g
• sat. fat 1g • chol. 2mg • sod. 29mg • calc. 1mg • fiber 0g*

Mango Salsa

Mango salsa is excellent served over grilled fish such as salmon, tuna, swordfish or scallops, and grilled chicken, duck or pork tenderloin. It can also be served like traditional tomato salsa with tortilla chips.

Makes 1 cup

- ¼ red bell pepper (about 1 ounce), cut into ½-inch pieces (¼ cup)**
- 1 small garlic clove, peeled**
- ½ jalapeño pepper, stemmed and seeded, cut into ½-inch pieces**
- ½ small red onion (about 1½ ounces), peeled, cut into ½-inch pieces**
- 1 mango (12–14 ounces), peeled and pitted, cut in ½-inch pieces**
- ½ tablespoons fresh cilantro leaves**

-
- 2** **teaspoons fresh lime juice**
 - 1½** **teaspoons rice vinegar (may use raspberry or white balsamic vinegar)**
 - ½** **teaspoon honey**

Insert the blade assembly in the prep bowl. Put the red bell pepper pieces into the prep bowl and use the pulse to coarsely chop, 6–8 pulses. Transfer to a 1-quart bowl and reserve. Add the garlic, jalapeño pepper and onion to the prep bowl, pulse 5 to 10 times to chop. Remove and add to chopped red pepper. Add mango and cilantro to prep bowl and pulse until mango reaches desired chopped consistency, about 10 to 20 pulses. Transfer to the bowl with the chopped red pepper and reserve. Stir in the lime juice, vinegar, and honey. Cover and let sit for 30 minutes to allow the flavors to blend. If not using immediately, cover and refrigerate. Mango Salsa is best when served the day it is prepared, but may be prepared up to one day ahead. Remove from the refrigerator 30 minutes before serving for best flavor.

Nutritional information per ¼ - cup serving:

*Calories 45 (3% from fat) • carb. 12g • pro. 1g • fat 0g
• sat. fat 0g • chol. 0mg • sod. 28mg • calc. 11mg • fiber 1g*

Guacamole

An all-time favorite, served with guacamole with tortilla chips or vegetable crudités.

Makes ⅔ cups

- 1** **garlic clove, peeled and smashed**
- 1** **green onion, trimmed and cut into ½-inch pieces**
- ½** **jalapeño pepper, cored, seeded and cut into ½-inch pieces**
- 1** **ripe avocado (about 10 ounces), peeled and pitted, cut into ¾-inch chunks**
- 1** **tablespoon fresh lime juice**
- ¼** **teaspoon cumin**
- ¼** **teaspoon powdered coriander**
- ¼** **teaspoon kosher salt**

Insert the blade assembly in the prep bowl. Put the garlic, green onion and jalapeño pepper into the prep bowl. Pulse to chop, 10–12 times. Add avocado, lime juice, cumin, coriander and salt. Pulse to chop avocado, 10 times, then process continuously until desired consistency is reached, stopping every 20 to 30 seconds to scrape the bowl.

Transfer to a serving bowl, cover with plastic wrap placed directly on the guacamole and refrigerate for 30 minutes before serving, to allow the flavors to blend.

Nutritional analysis per tablespoon:

*Calories 25 (72% from fat) • carb. 2g • pro. 0g • fat 2g
• sat. fat 0g • chol. 0mg • sod. 65mg • calc. 3mg • fiber 1g*

Roasted Pepper Tapenade

Makes 1 cup

- 1** small garlic clove, peeled
- 1** jar (12-ounces) of roasted peppers, drained, cut into 1-inch pieces
- ½** sun-dried tomato (oil packed)
- 2** tablespoons green pimento-stuffed olives, drained
- ½** teaspoon fresh thyme
- ½** teaspoon extra virgin olive oil
- pinch salt
- pinch pepper

Insert the blade assembly in the prep bowl. Put garlic into the prep bowl and process for 10–15 seconds; scrape bowl.

Add remaining ingredients to prep bowl and pulse evenly 10–15 times to reach desired consistency. Season to taste. Serve with crackers or crostini.

Nutritional information per ¼ - cup serving:

*Calories 50 (42% from fat) • carb. 5g • pro. 1g • fat 2g
• sat. fat 0g • chol. 0mg • sod. 481mg • calc. 16mg • fiber 1g*

White Bean Spread

Makes 1¼ cups

- 1** small garlic clove, peeled
- 6** fresh sage leaves
- ½** ounce tomato
- 1** can (19 ounces) cannellini beans (or other white beans), rinsed and drained
- 2** teaspoons extra virgin olive oil
- ½** teaspoon kosher salt
- fresh ground pepper to taste

Insert the blade assembly in the prep bowl. Put garlic into the prep bowl and process for 30 seconds. Add sage and pulse 4 times. Add tomato and pulse 4 times. Add remaining ingredients to prep bowl and pulse evenly 6–10 times to reach desired consistency. Season to taste. Serve with crackers or as a topping for bruschetta. For a smoother spread, add 2–4 tablespoons water and process until smooth and creamy.

Nutritional information per ¼ - cup serving:

*Calories 120 (15% from fat) • carb. 20g • pro. 6g • fat 2g
• sat. fat 0g • chol. 0mg • sod. 239mg • calc. 67mg • fiber 4g*

Tomato and Basil Topping

Makes 1 cup

- 1** small garlic clove, peeled
- 1½** tablespoons fresh basil leaves
- 1** pint grape tomatoes
- 3** teaspoons extra virgin olive oil
- ½** teaspoon salt

Insert the blade assembly in the prep bowl. Put garlic into the prep bowl and run for 30 seconds. Add basil and pulse 4 times.

Add remaining ingredients to prep bowl and pulse about 10–15 times to reach desired consistency. Season to taste. Serve as topping for bruschetta.

Nutritional information per serving:

*Calories 50 (61% from fat) • carb. 4g • pro. 1g • fat 4g
• sat. fat 1g • chol. 0mg • sod. 301mg • calc. 8mg • fiber 1g*

DESSERTS

Chocolate Pistachio Macaroons

A change from the traditional almond macaroon.

Makes about 30 cookies

- ¾** cup granulated sugar
- ½** cup shelled pistachios, unsalted
- ¼** cup Dutch processed cocoa
- 4** large egg whites
- 1** cup mini-chocolate morsels

Preheat oven to 325°F. Line two 15 x 11½-inch baking sheets with parchment paper.

Insert the blade assembly into the prep bowl. Put ¼ cup of the sugar and the pistachios in the prep bowl and process for 30–40 seconds until finely ground. Add cocoa and pulse 6 times to incorporate.

Put egg whites in a glass or stainless mixing bowl. Insert the blender fitted with the whisk attachment and beat whites. After 1½ minutes add the batter remaining ½ cup of sugar. Whites should reach firm peaks after 3 minutes.

Fold the pistachio and cocoa mixture into the egg whites in three increments with a rubber spatula. Gently fold in the chocolate morsels, taking care not to deflate the batter.

Drop the batter in spoonfuls (2 tablespoons) onto the prepared baking sheets. Bake in preheated 325°F oven for 35–40 minutes, until the cookies lift easily from the baking sheet and cookie bottoms are smooth.

Transfer the parchment with the cookies from the hot pan to a cool surface. Peel off the paper and store in airtight container once cooled.

Nutritional information per macaroon:
Calories 76 (38% from fat) • carb. 11g • pro. 1g • fat 3g
• sat. fat 1g • chol. 0mg • sod. 11mg • calc. 4mg • fiber 2g

Sweet Whipped Cream

Sweetened whipped cream is the perfect finish for just about any dessert, or spoon a dollop over coffee or hot chocolate.

Makes 2 cups

1¼ cups heavy cream, chilled
2 tablespoons granulated sugar
1½ teaspoons pure vanilla extract

Put the cream, sugar, and vanilla into a large stainless or glass mixing bowl. Insert the blender fitted with the whisk attachment. Start the blender but be careful to have the whisk just skim the surface of the cream. Blend until the cream gains some body and then move the blender in an up-and-down motion throughout the bowl. Whipped cream will reach soft peaks between 50 - 60 seconds.

Nutritional information per serving (2 tablespoons):
Calories 70 (86% from fat) • carb. 2g • pro. 0g • fat 7g
• sat. fat 4g • chol. 25mg • sod. 7mg • calc. 12mg • fiber 0g

Cocoa Whipped Cream: Place 1¼ cups heavy cream, 3 tablespoons granulated sugar, 1 tablespoon unsweetened cocoa, and 1 teaspoon vanilla in mixing bowl. Whip as directed.

Berry Coulis

This versatile dessert sauce could not be easier.

Makes 1¼ cup

1 frozen mixed berries, thawed (12-ounces)
¼ cup granulated sugar
½ teaspoon fresh lemon juice

Put all ingredients in a 2½- quart saucepan. Over medium heat bring mixture to a simmer and cook for about 5 minutes to melt the sugar. Insert the blender into the saucepan, making sure the protective guard is submerged. Blend, using an up-and-down motion, until ingredients are well combined, about 30–40 seconds. Strain the sauce through a fine mesh strainer and serve.

Nutritional information per ¼ - cup serving:
Calories 86 (4% from fat) • carb. 22g • pro. 0mg • fat 0g
• sat. fat 0g • chol. 0mg • sod. 25mg • calc. 14mg • fiber 4g

WARRANTY

LIMITED THREE-YEAR WARRANTY

This warranty is available to consumers only. You are a consumer if you own a Cuisinart® Smart Stick® Hand Blender that was purchased at retail for personal, family or household use. Except as otherwise required under applicable law, this warranty is not available to retailers or other commercial purchasers or owners.

We warrant that your Cuisinart® Smart Stick® Hand Blender will be free of defects in materials and workmanship under normal home use for 3 years from the date of original purchase.

We recommend that you visit our website, **www.cuisinart.com** for a fast, efficient way to complete your product registration. However, product registration does not eliminate the need for the consumer to maintain the original proof of purchase in order to obtain the warranty benefits. In the event that you do not have proof of purchase date, the purchase date for purposes of this warranty will be the date of manufacture.

If your Cuisinart® Smart Stick® Hand Blender should prove to be defective within the warranty period, we will repair it, or if we think necessary, replace it. To obtain warranty service, simply call our toll-free number 1-800-726-0190 for additional information from our Customer Service Representatives or send the defective product to Customer Service at

Cuisinart
7811 North Glen Harbor Blvd.
Glendale, AZ 85307.

To facilitate the speed and accuracy of your return, please enclose \$10.00 for shipping and handling of the product.

Please pay by check or money order (California residents need only supply proof of purchase and should call 1-800-726-0190 for shipping instructions).

NOTE: For added protection and secure handling of any Cuisinart product that is being returned, we recommend you use a traceable, insured delivery service. Cuisinart cannot be held responsible for in-transit damage or for packages that are not delivered to us. Lost and/or damaged products are not covered under warranty.

Please be sure to include your return address, daytime phone number, description of the product defect, product model # (located on bottom of product), original date of purchase, and any other information pertinent to the product's return.

CALIFORNIA RESIDENTS ONLY

California law provides that for In-Warranty Service, California residents have the option of returning a nonconforming product

(A) to the store where it was purchased or

(B) to another retail store that sells Cuisinart products of the same type.

The retail store shall then, at its discretion, either repair the product, refer the consumer to an independent repair facility, replace the product, or refund the purchase price less the amount directly attributable to the consumer's prior usage of the product. If either of the above two options

does not result in the appropriate relief to the consumer, the consumer may then take the product to an independent repair facility if service or repair can be economically accomplished. Cuisinart and not the consumer will be responsible for the reasonable cost of such service, repair, replacement, or refund for nonconforming products under warranty.

California residents may also, according to their preference, return nonconforming products directly to Cuisinart for repair, or if necessary, replacement, by calling our Consumer Service Center toll-free at 1-800-726-0190.

Cuisinart will be responsible for the cost of the repair, replacement, and shipping and handling for such products under warranty.

BEFORE RETURNING YOUR CUISINART® PRODUCT

If you are experiencing problems with your Cuisinart® product, we suggest that you call our Cuisinart® Service Center at 1-800-726-0190 before returning the product to be serviced. If servicing is needed, a Representative can confirm whether the product is under warranty and direct you to the nearest service location.

Your Cuisinart® Smart Stick® Hand Blender has been manufactured to the strictest specifications and has been designed for use only in 120 volt outlets and only with authorized accessories and replacement parts. This warranty expressly excludes any defects or damages caused by attempted use of this unit with a converter, as well as use with accessories, replacement parts or repair service other than those authorized by Cuisinart. This warranty does not cover any damage caused by accident, misuse, shipment or other than ordinary household use. This warranty excludes all incidental or consequential damages. Some states do not allow the exclusion or limitation of these damages, so these exclusions may not apply to you. You may also have other rights, which vary from state to state.

Important: If the nonconforming product is to be serviced by someone other than Cuisinart's Authorized Service Center, please remind the servicer to call our Consumer Service Center at 1-800-726-0190 to ensure that the problem is properly diagnosed, the product is serviced with the correct parts, and the product is still under warranty.

Cuisinart®

SAVOR THE GOOD LIFE®



Coffeemakers



Blenders



Juicers



Cookware



Tools and
Gadgets

Cuisinart offers an extensive assortment of top quality products to make life in the kitchen easier than ever. Try some of our other countertop appliances and cookware.

www.cuisinart.com

Other trademarks or service marks referred to herein are the trademarks or service marks of their respective owners.

©2011 Cuisinart
150 Milford Road
East Windsor, NJ 08520
Printed in China
11CE126215

IB-5338C

Free Manuals Download Website

<http://myh66.com>

<http://usermanuals.us>

<http://www.somanuals.com>

<http://www.4manuals.cc>

<http://www.manual-lib.com>

<http://www.404manual.com>

<http://www.luxmanual.com>

<http://aubethermostatmanual.com>

Golf course search by state

<http://golfingnear.com>

Email search by domain

<http://emailbydomain.com>

Auto manuals search

<http://auto.somanuals.com>

TV manuals search

<http://tv.somanuals.com>