

Cuisinart®

INSTRUCTION
BOOKLET



CLASSIC STYLE, CHROME FINISH 4-Slice Electronic Toaster

CPT-90C

TABLE OF CONTENTS:

Important Safeguards	Pg 2
Introduction	Pg 2
Features and Benefits	Pg 3
Use and Care	Pg 4
Browning Notes, Specialty Uses	Pg 4
Two Slice Toasting	Pg 5
Single Slice Toasting	Pg 5
Custom Settings	Pg 5
Defrost Button	Pg 5
Reheat Button	Pg 6
Cleaning and Maintenance	Pg 6
Warranty	Pg 7

IMPORTANT SAFEGUARDS

When using an electrical appliance, basic safety precautions should always be followed including the following:

1. **Read all instructions.**
2. **Do not touch hot surfaces. Use handles or knobs.**
3. To protect against electrical shock, do not place any part of the toaster in water or other liquid. See instructions for cleaning.
4. Close supervision is necessary when any appliance is used by or near children.
5. **UNPLUG FROM OUTLET WHEN NOT IN USE AND BEFORE CLEANING.** Allow to cool before cleaning or handling.
6. Do not operate any appliance with a damaged cord or plug or after the appliance has malfunctioned or has been dropped or damaged in any way or if it is not operating properly. Return the toaster to the nearest Cuisinart Repair Center for examination, repair,

mechanical or electrical adjustment.

7. The use of accessory attachments not recommended by Cuisinart may cause injury.
8. Do not use outdoors.
9. Do not let cord hang over the edge of the table or countertop or touch hot surfaces.
10. Do not place toaster on or near a hot gas or electric burner or in a heated oven.
11. To disconnect, turn any control to "OFF", then remove plug from wall outlet.
12. Do not use this toaster for other than intended use.
13. **Oversize foods, metal foil packages or utensils must not be inserted in the toaster as they may involve a risk of fire or electric shock.**
14. **A fire may occur if the toaster is covered or touching flammable materials, including curtains, draperies, walls and the like when in operation. Do not operate under wall cabinets.**

15. Do not attempt to dislodge food when the toaster is plugged into electrical outlet.

16. To avoid possibility of fire, do not leave toaster unattended during use. Unplug when not in use.

SAVE THESE INSTRUCTIONS

SPECIAL CORD SET INSTRUCTIONS

A short power-supply cord is provided to reduce the risks resulting from becoming entangled in or tripping over a longer cord.

Longer extension cords are available and may be used if care is exercised in their use.

If a long extension cord is used, the marked electrical rating of the extension cord must be at least as great as the electrical rating of the

appliance, and the longer cord should be arranged so that it will not drape over the counter top or table top where it can be pulled on by children or tripped over.

NOTICE

This appliance has a polarized plug (one blade is wider than the other). As a safety feature, this plug will fit into a polarized outlet only one way. If the plug does not fit fully into the outlet, reverse the plug. If it still does not fit, contact a qualified electrician. Do not attempt to defeat this safety feature.

INTRODUCTION

In the tradition of Cuisinart, the 4-Slice Classic Style Electronic Toaster meets our strict performance standards. The handsome chrome-plated design combines the warm memories of yesterday with the quality of today's technology.

This attractive toaster makes quick work of breakfast for two or more. Long wide slots toast a variety of items from long slices of Italian bread, to small English Muffins, to fresh homemade breads. Bagels too! Our energy-saving switch turns off the back slot when you only need one or two slices toasted. Our Extra Lift feature brings toasted breads close to the top of the toaster making it easy to remove small items, like English Muffins. We also include the convenient Reheat and Defrost features, with LED displays.

Thank you for bringing a Cuisinart® Classic Style Electronic Toaster home with you. We believe strongly enough in our toaster to give you a three year limited warranty, but we believe you'll keep our toaster a lot longer than that, because we're working hard to bring you better toast and cooking convenience.

FOR HOUSEHOLD USE ONLY

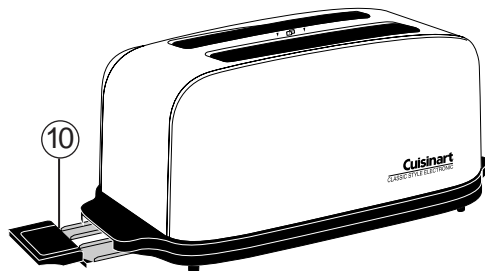
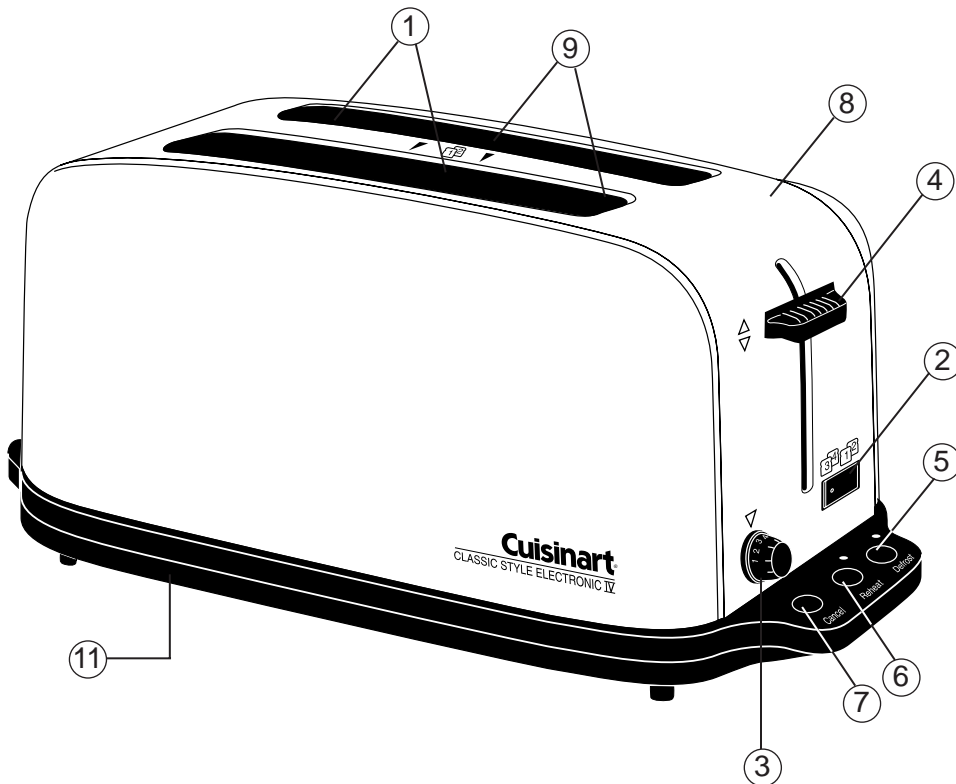

FEATURES AND BENEFITS

MODEL CPT-90C

1. Wide...Long Toasting Slots:

1-3/8" Wide Toaster Slot is 10" long. Large toasting slots hold a variety of breads, from English Muffins, to thick homemade slices to long slices of Italian bread. Bagels too! Easily holds 4 regular size slices.

2. Slice Control Switch:

Energy Saving Switch that shuts off the back heater when toasting only one or two slices, to prevent overtoasting.

3. Browning Control:

Easy to grip rotary dial sets desired toast color from light to dark, with six browning levels.

4. Extra Lift Carriage Control Lever:

Push down to lower bread into slot and start toaster. Push up to bring toast close to the top of the toaster, making it easy to remove smaller foods.

5. Defrost Control:

Defrosts and then toasts frozen breads by adding time to the toast cycle. LED Indicator lights when selected.

6. Reheat Control:

Reheats without browning or toasting. LED Indicator lights when selected.

7. Cancel Control:

Interrupts toasting process.

8. Always Even™ Shade Control:

Electronic control constantly monitors toaster's internal temperature to provide consistent toasting results from one use to the next. Heating elements deliver uniform heat for even browning.

9. Self-Centering Bread Racks:

Centers all shapes & sizes of bread in the middle of toaster chamber for more even toasting results.

10. Slide-out Crumb Tray:

Removes easily to clean crumbs from bottom of toaster.

11. Cord Storage:

Takes up excess cord and keeps countertop neat.

USE AND CARE

Unwind the power cord. Check that the crumb tray is in place and that there is nothing in the toaster slot. Plug power cord into the wall outlet.

1. Insert slice(s) of bread.

Be sure that multiple slices do not overlap and that the bread carriage is in the up position.

2. Set the Browning Control.

Turn the rotary Browning Dial to the desired position. Toast gets darker as the dial is turned clockwise from left to right. The Browning Dial can be adjusted either before or after pressing down the Carriage / Start Lever.

Setting	Color
1-2	light
3-4	medium
5-6	dark

3. Set Slice Control Switch.

If toasting one or two slices, use the front slot. Set the 2-position rocker switch to the 1 Slice/2 Slice [1²] setting. When toasting three or four slices, set the switch to the 3 Slice/4 Slice [3⁴] position. Switch is located on the right side of the toaster above the Defrost button.

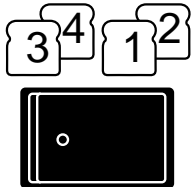

4. Begin Toasting.

Press the Carriage Control Lever until it locks into the down position. The toaster will start.

5. Select Custom Settings.

If desired, select the Defrost or Reheat Setting after the Carriage Control Lever is pushed down. If no special settings are selected, the toaster will brown your toast based on the selection you made with the browning dial.

Defrost - To defrost, then toast. Adds time to the toast cycle for defrosting.

Reheat - For reheating pre-toasted bread.

When choosing these special settings a red LED light will come on above the selected feature button.

6. To Stop Toasting.

When the toasting cycle is finished, the toast will be raised. If you wish to stop the cycle before it is finished, simply press the Cancel Button. You can also lift up the Carriage Control Lever to stop the cycle.

7. To Remove Toast.

Lift the Extra-Lift Carriage Control until it reaches its highest point. This is especially useful when toasting smaller breads.

Helpful Browning Notes:

Toasting is a combination of cooking and drying of the bread. Therefore, differences in moisture level from one bread to another can result in varying toasting times.

- For slightly dry bread, use a lower setting than you normally would.
- For very fresh bread or whole wheat bread, use a darker setting than normal.
- Breads with very uneven surfaces (such as English Muffins) will require a higher browning setting.

- Thickly cut pieces of bread and bagels will take longer to toast, sometimes significantly longer, since more moisture must be evaporated from the bread before toasting can occur. Very thick pieces may require two cycles.

- When toasting raisin breads, fruit breads, or fruit muffins, remove any loose fruit, etc. from the surface of the bread before placing into the toaster. This will help prevent them from falling into the toaster or sticking on the guard wires in the slot.

- Before toasting bagels, slice each bagel into two equal halves.

- Most 4-slice toasters generate so much heat that when 2 slices are toasted, they can be overtoasted. By positioning the Slice Control Switch in the 1-Slice/2-Slice position [1²], the Cuisinart® 4-Slice Toaster generates less heat and better toasting results.

- A single slice of toast requires less toasting time than two slices of bread. To prevent overtoasting of a single slice, put bread in the front slot, set the Slice Control Switch to the 1-Slice/2-Slice position [1²], and set the Browning Control to a lighter setting than you normally would. Each chamber is designed for 2 slices of bread. By lowering the toasting time for a single slice, your toast won't get too brown.

Notes on Specialty Uses:

Toaster Pastries.

Exercise caution with toaster pastries. The filling can become quite hot long before the surface of the pastry becomes browned. A low setting should be sufficient. Never leave toaster pastries unattended while toasting or warming. Avoid iced pastries. The icing can melt onto the interior of the toaster and can burn as well.

English Muffins & Thick Sliced Breads.

Requires longer toasting time than regular breads. We suggest that you increase the darkness setting on the Browning Dial to increase the toasting time.

Long Slices of Bread.

If your bread slice is so long that a toaster slot can only accommodate a single slice, we suggest that you set the Browning Control to a lighter setting than you normally would.

Frozen Breads.

The following breads and pastries should be defrosted and warmed using the Defrost Button:

Frozen Waffles, Pancakes, French Toast and Bagels



Press the Defrost Button when defrosting and toasting waffles, pancakes, French toast and bagel halves. For best results use a few toasting cycles at a low setting. A single longer toasting time can result in waffles, pancakes or French toast that are toasted on the outside but cool or soggy on the inside.

Tips:

- Never force foods into the Toasting Slot. Foods should fit freely between the guard (guide) wires.
- Do not place buttered breads or frosted pastries in the toaster, as it could create a fire hazard.
- Uneven toasting is usually due to bread slices of uneven thickness.
- Never insert hard objects into the toasting slot.
- After use, unplug your toaster from the electrical outlet.

Two-Slice Toasting:

Most 4-slice toasters generate so much heat that when 2 slices are toasted the bread can be overtoasted. For two slices of regular size bread, follow these steps:

1. Set the Slice Control Switch to the 1-Slice/2-Slice position . This will reduce the amount of heat generated and give better toasting results.
2. Put both slices of bread in the front toaster slot. This is the slot on the side of the toaster with the Cuisinart name on it. Putting the Slice Control Switch in the 1-Slice/2-Slice position turns OFF the back chamber. 
3. Start the toaster as you normally would (Push down the carriage control lever).

Single Slice Toasting:

A single slice of toast requires less toasting time than two slices of bread. Each chamber is designed for 2 slices of regular size bread. Lower the toast time for a single slice by turning the Browning Dial to a lighter setting. This will prevent overtoasting the bread slice. For one slice of regular sized bread, follow these steps:

1. Set the Slice Control Switch to the 1-Slice/2-Slice position . This will turn off the back chamber to reduce the amount of heat generated, and give better toasting results.
2. Put the slice of bread in the front toaster slot. This is on the side of the toaster with the Cuisinart name on it. It is also marked with arrows ▼ which point to the front slot.
3. Set the Browning Control to a lighter setting than you normally would for 2 slices.
4. Start the toaster as you normally would (Push down the carriage control lever).

CUSTOM SETTINGS

Defrost Button

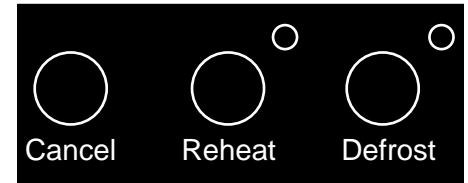

The Defrost Button is designed to first defrost and then toast the bread, by extending the toasting cycle slightly.

1. Insert slice(s) of bread:

Be sure that multiple slices do not overlap and the carriage is in the up position.

2. Set the Browning Control:

Select desired browning level from light to dark with rotary browning dial.

3. Set the Slice Control Switch to the 1 Slice/2 Slice or 3 Slice/4 Slice position, as needed.

4. Press the Carriage Control Lever down until it locks into position.

5. Press the Defrost Button.

The LED will illuminate when this feature is selected.

To stop cycle:

When the Defrost and Toast Cycle is complete, the toaster will raise the bread. If you wish to stop the cycle before it is finished, simply press the Cancel Button to interrupt at any time. To remove toast, lift the Extra-Lift Carriage Control until it reaches its highest point. This is especially useful when toasting smaller breads.

Reheat Button

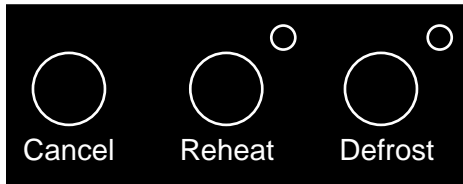

The Reheat feature allows you to reheat toasted bread without browning or toasting.

1. Insert slice(s) of bread:

Be sure that multiple slices do not overlap and the carriage is in the up position.

2. Set the Slice Control Switch to the 1 Slice/2 Slice¹2 or 3 Slice/4 Slice³4 position, as needed.

3. Press the Carriage Control Lever until it locks into position.

4. Press the Reheat Button.

You do not have to set the Browning Dial as this cycle will not brown or toast the bread.

To stop cycle:

When the Reheat Cycle is complete, the toaster will raise the bread. If you wish to stop the cycle before it is finished, simply press the Cancel Button to interrupt or lift up on the Carriage Control Lever. To remove toast, lift the Extra-Lift Carriage Control until it reaches its highest point. This is especially useful when toasting smaller breads.

CLEANING AND MAINTENANCE

Always allow the toaster to cool completely before cleaning.

1. Always unplug the toaster from the electrical outlet.

2. Do not use abrasive cleansers. Simply wipe the exterior with a clean damp cloth and dry thoroughly. Apply any cleansing agent to a cloth, not to the toaster, before cleaning.

3. To remove crumbs, slide out the Crumb Tray and discard crumbs. Wipe clean and replace. Never operate the toaster without the Crumb Tray in place.

4. To remove any pieces of bread remaining in the toaster, turn the toaster upside down and gently shake. Never insert any hard or sharp instruments into the slot as this could damage the toaster and cause a safety hazard.

5. Never wrap the cord around the outside of the toaster. Use the cord storage cleats on the underside of the toaster.

FOR HOUSEHOLD USE ONLY

CUISINART® CLASSIC STYLE TOASTER 3 YEAR LIMITED WARRANTY

This limited warranty is available to consumers only. You are a consumer if you own a Cuisinart® Toaster which was purchased at retail for personal, family or household use. This warranty is not available to retailers or other commercial purchasers or owners.

We warrant that your Cuisinart® Toaster will be free of defects in materials and workmanship under normal home use for three years from the original date of purchase.

We suggest you complete and return the enclosed warranty registration card promptly. However, return of the card is not a condition of this warranty and does not eliminate the need for the consumer to maintain the original receipt of purchase.

If your unit should prove to be defective within the warranty period, we will repair or replace it at our option, without charge to you. To obtain warranty service, contact: Cuisinart Canada, 156 Parkshore Drive, Brampton, Ont. L6T 5M1 or call toll-free: 1-800-472-7606.

To facilitate the speed and accuracy of your return, please also enclose \$7.00 for shipping and handling of the product. Please be sure to include a return address, description of the product defect, product serial number and any other information pertinent to the product's return. Please pay by cheque or money order.

Your Cuisinart® Toaster has been manufactured to the strictest specifications and has been designed for use with authorized Cuisinart® accessories and replacement parts. This warranty expressly excludes any defects or damages caused by accessories, replacement

parts or repair service other than those which have been authorized by Cuisinart. This limited warranty does not cover any damage caused by accident, misuse, shipment or other than ordinary household use.

THIS WARRANTY EXCLUDES ALL INCIDENTAL OR CONSEQUENTIAL DAMAGES. ALL APPLICABLE IMPLIED WARRANTIES, INCLUDING THE IMPLIED WARRANTY OF MERCHANTABILITY AND FITNESS FOR A PARTICULAR PURPOSE, GIVEN TO YOU BY LAW, ARE HEREBY LIMITED IN DURATION TO THIS WARRANTY.

If you have any questions about the safety features of your Cuisinart® Toaster, please call us, toll-free, at 1-800-472-7606.

© 2000 Cuisinart
Cuisinart® is a registered trademark
of Cuisinart
Cuisinart Canada
156 Parkshore Drive
Brampton Ont. L6T 5M1
Printed in China
IB-2696-CAN-C
97CC13523

Free Manuals Download Website

<http://myh66.com>

<http://usermanuals.us>

<http://www.somanuals.com>

<http://www.4manuals.cc>

<http://www.manual-lib.com>

<http://www.404manual.com>

<http://www.luxmanual.com>

<http://aubethermostatmanual.com>

Golf course search by state

<http://golfingnear.com>

Email search by domain

<http://emailbydomain.com>

Auto manuals search

<http://auto.somanuals.com>

TV manuals search

<http://tv.somanuals.com>