

SPECIFICATIONS

Television System:	NTSC
Receiving channel:	181 channel tuner (Frequency synthesized tuning)
Audio output:	2 speakers of 5W each
Audio output mode:	RF-MONO
Antenna impedance:	75 ohm terminal
Output terminal:	Video input 1vp-p/75 Ohm, audio input 400mV
Closed caption:	NTSC/M receiving time (cc1-cc4/tt1-tt4)
OSD Language:	English/French
Power:	AC 120V, 50/60 Hz
Measurements (Length Width Height):	20" – 590 x 475 x 449 (mm)
Net Weight:	20" – 20 kg
Accessories:	one remote control one instruction manual two batteries (AAA)



TV2040 20" VIRTUAL FLAT TV Colour Television



TROUBLESHOOTING GUIDE

Should this unit exhibit a problem, check the following before seeking service:

Symptoms	Solution	Try different channel, if it is okay, it is probably a station trouble	Check aerial connections on back of set	Check aerial for broken wires	Re-orient aerial (if indoor type)	Probably local interference, such as an appliance	Adjust fine tuning control	Adjust brightness control	Adjust contrast control	Check if station is broadcasting in colour	Adjust colour control	Check if system switch is correct	Check if on/off switch is on	Check Batteries in Remote control
No picture, no sound		•	•	•			•					•	•	
Poor sound, picture OK		•			•	•	•					•		
Poor picture, sound OK		•	•	•	•	•	•	•				•		
Weak picture		•	•	•	•		•					•		
Blurred picture		•		•	•							•		
Double image		•	•	•	•		•							
Lines in picture		•		•	•	•	•							
Distorted picture		•		•	•		•					•		
Weak reception of some channels		•	•	•	•	•	•					•		
Horizontal lines in picture				•	•									
Picture rolls vertically		•		•	•	•						•		
Poor colour		•	•	•	•	•	•	•		•	•	•		
No colour in picture		•	•	•	•		•			•	•	•		
Erratic performance from remote control														•
Remote Control does not work														•
On Screen Display control outside the screen												•		

OPERATION MANUAL

Please read these instructions carefully
Before operating this product

INTRODUCTION

Thank you for purchasing our product. To ensure that you fully understand the capabilities of this television set, please read this entire manual carefully, and keep it handy for future reference.

INSTALLATION

- Locate the TV set in a room where direct light does not reflect on the screen. Total darkness or a reflection on the picture screen can cause eye strain. Soft and indirect lighting is recommended for comfortable viewing.
- Allow enough space between the TV set and the wall to permit ventilation. Avoid excessively warm locations to prevent possible damage to the cabinet or premature component failure.
- Never connect this TV set to DC supply or any other power supply than the one indicated in SPECIFICATIONS section.
- Do not install the TV set in a location near heat sources such as a radiator, air ducts, and direct sunlight or in a closed area without proper ventilation.
- Do not cover the ventilation openings when using the TV set.

CAUTION

Never tamper with any components inside the set or adjust any controls other than those mentioned in this manual. All television receivers are high voltage instruments and the tube is manufactured using a vacuum process. If the tube is broken, glass fragments will be violently expelled. Scratching or chipping of the tube is dangerous and should be avoided. When cleaning the television ensure the set is unplugged and use only a dry soft cloth to remove the dust. During a thunder storm unplug both the power cord and aerial plug to protect the set from damage. Only a qualified technician should attempt any adjustments or repairs inside the television.

IMPORTANT SAFETY INFORMATION

WARNING: TO PREVENT FIRE OR SHOCK HAZARD, DO NOT EXPOSE THIS APPLIANCE TO RAIN OR MOISTURE.



The lightning flash with arrowhead symbol, within an equilateral triangle is intended to alert the user to the presence of uninsulated dangerous voltage within the product's enclosure that may be of sufficient magnitude to constitute a risk of electric shock.



The exclamation point within an equilateral triangle is intended to alert the user to the presence of important operating and maintenance (servicing) instructions in the literature accompanying the appliance.

6. FINE

1. Press P+ or P- button to select the FINE option.
2. Press V+ or V- button to make fine tuning for the current channel.



7. AUTO SEARCH

1. Press P+ or P- button to select AUTO SEARCH option.
2. Press V+ button to start automatic searching program.

- ☺ Note: You can stop searching by pressing V- button, or wait until all the programs are searched and stored.
If you set CATV in option 3 (TV/CATV), the AUTO SEARCH only search CATV signal. If you want to search TV program, please set TV option first.



Function menu

Press the MENU button repeatedly to select the FUNCTION menu.

1. LANGUAGE

1. Press P+ or P- button to select LANGUAGE option.
2. Press V+ or V- button to select the language for OSD menu.
There are ENGLISH, FRENCH



2. CLOSED CAPTION

1. Press P+ or P- button to select CLOSED CAPTION option.
2. Press V+ or V- button to open CCD then select CCD mode, like C1, C2, ...

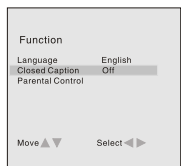

3. PARENTAL CONTROL (OPTIONAL)

1. Press P+ or P- button to select PARENTAL CONTROL option.
2. Press V+ or V- button to enter V-CHIP menu.

- ☺ Note: This function is optional, only available in USA and Canada.
DEFAULT PASSWORD IS 0000.

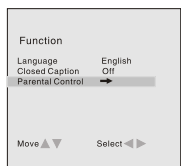

Tuning menu

Press the MENU button repeatedly to select the FUNCTION menu.

1. CHANNEL

1. Press P+ or P- button to select CHANNEL option.
2. Press V+ or V- button to change the channel directly.

 Note: The position you set is for the following options.

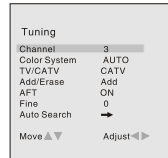

2. COLOR SYSTEM

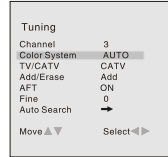
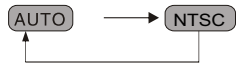

1. Press P+ or P- button to select COLOR SYSTEM option.
2. Press V+ or V- button to select the color system for the current channel as following:



3. TV/CATV

1. Press P+ or P- button to select TV/CATV option.
2. Press V+ or V- button to select the TV signal mode: TV or CATV

4. ADD/ERASE

1. Press P+ or P- button to select ADD/ERASE option.
2. If you set ADD, the current channel (for example, channel 3) will display when you press P- or P+ button or this channel button ( button) during watching TV.
3. If you set ERASE, the current channel (for example, channel 3) will disappear when you press P- or P+ button during watching TV, if you directly press this channel button ( button), there is no signal in this channel, and the color of the channel No. is red.

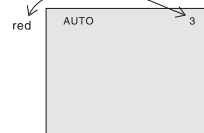
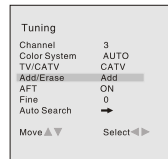

5. AFT

1. Press P+ or P- button to select the AFT option.
2. Press V+ or V- button to enable or disable AFT function (Auto Frequency Tracking).

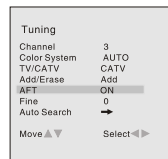

IMPORTANT SAFEGUARDS

- 1. READ INSTRUCTIONS**
All the safety and operating instructions should be read before the unit is operated.
- 2. RETAIN INSTRUCTIONS**
The safety and operating instructions should be retained for future reference.
- 3. HEED WARNINGS**
All warnings on the unit and in the operating instructions should be adhered to.
- 4. FOLLOW INSTRUCTIONS**
All operating and use instructions should be followed.
- 5. CLEANING**
Unplug this unit from the wall outlet before cleaning. Do not use liquid cleaners or aerosol cleaners.
- 6. ATTACHMENTS**
The manufacturer of this unit does not make any recommendations for attachments, as they may cause hazards.
- 7. WATER AND MOISTURE**
Do not use this unit near water. For example, near a bathtub, washbowl, kitchen sink, laundry tub, in a wet basement, or near a swimming pool.
- 8. ACCESSORIES**
Do not place this unit on an unstable cart, stand, tripod, bracket, or table. The unit may fall, causing serious injury and serious damage to the unit.

An appliance and cart combination should be moved with care. Quick stops, excessive force, and uneven surfaces may cause the appliance and cart combination to overturn.
- 9. VENTILATION**
Slots and openings in the cabinet back or bottom are provided for ventilation, and to ensure reliable operation of the unit, and to protect it from overheating. These openings must not be blocked or covered; the openings should never be blocked by placing the unit on a bed, sofa, rug, or other similar surface. This unit should never be placed near or over a radiator or heat source. This unit should not be placed in a built-in installation such as a bookcase or rack unless proper ventilation is provided or the manufacturer's instructions have been adhered to.

PORTABLE CART WARNING
(symbol provided by RETAC)



- 10. POWER SOURCE**
This unit should be operated only from the type of power source indicated on the rating plate. If you are not sure of the type of power supply to your home, consult your appliance dealer or local power company. For units intended to operate from battery power, or other sources, refer to the respective pages in this User Manual for their operating instructions.

- 11. GROUNDING OR POLARIZATION**
This unit is equipped with a polarized alternating current line plug (plug having one blade wider than the other). This plug will fit into the power outlet only one way. This is a safety feature. If you are unable to insert the plug fully into the outlet, try reversing the plug. If the plug should still fail to fit, contact your electrician to replace your obsolete outlet. Instead of the polarized alternating-current line plug, your unit may be equipped with a 3-wire grounding-type plug (a plug having a third grounding pin). This plug will only fit into a grounding-type power outlet. This too, is a safety feature. If you are unable to insert the plug into the outlet, contact your electrician to replace your obsolete outlet. Do not defeat the safety purpose of the grounding-type plug.
- 12. POWER-CORD PROTECTION**
Power-supply cords should be routed so that they are not likely to be walked on or pinched by items placed upon or against them, paying particular attention to cords at plugs, convenience receptacles, and the point where they exit from the appliance.
- 13. LIGHTNING**
To protect your unit from a lightning storm, or when it is left unattended and unused for long periods of time, unplug it from the wall outlet and disconnect the antenna or cable system. This will prevent damage to the unit due to lightning and power line surges.
- 14. POWER LINES**
An outside antenna system should not be located in the vicinity of overhead power lines or other electric light or power circuits, or where it can fall onto or against such power lines or circuits. When installing an outside antenna system, extreme care should be taken to keep from touching such power lines or circuits, as contact with them might be fatal.
- 15. OVERLOADING**
Do not overload wall outlets and extension cords, as this can result in a risk of fire or electric shock.
- 16. OBJECT AND LIQUID ENTRY**
Do not push objects through any openings in this unit, as they may touch dangerous voltage points or short out parts that could result in fire or electric shock. Never spill or spray any type of liquid into the unit.
- 17. OUTDOOR ANTENNA GROUNDING**
If an outside antenna or cable system is connected to the unit, be sure the antenna or cable system is grounded to provide some protection against voltage surges and built-up static charges. Section 8 10 of the National Electrical Code (NEC), ANSI/NFPA 70, provides information with respect to proper grounding of the mast and supporting structure, grounding of the lead-in wire to an antenna discharge unit, size of grounding conductors, location of antenna discharge unit, connection to grounding electrodes, and requirements for the grounding electrode. See figure below.

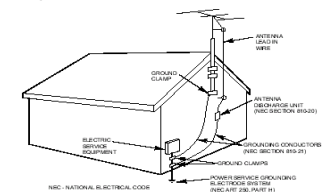

EXAMPLE OF ANTENNA GROUNDING AS PER NATIONAL ELECTRICAL CODE

18. SERVICING

Do not attempt to service this unit yourself as opening or removing covers may expose you to dangerous voltage or other hazards. Refer all servicing to qualified service personnel.

19. DAMAGE REQUIRING SERVICE

Unplug this unit from the wall outlet and refer servicing to qualified service personnel under the following conditions:

- When the power-supply cord or plug is damaged.
- If liquid has been spilled, or objects have fallen into the unit.
- If the unit has been exposed to rain or water.
- If the unit does not operate normally by following the operating instructions. Adjust only those controls that are covered by the operating instructions, as an improper adjustment of other controls may result in damage and will often require extensive work by a qualified technician to restore the unit to its normal operation.
- If the unit has been dropped or the cabinet has been damaged.
- When the unit exhibits a distinct change in performance, this indicates a need for service.

20. REPLACEMENT PARTS

When replacement parts are required, be sure the service technician uses replacement parts specified by the manufacturer or those that have the same characteristics as the original part. Unauthorized substitutions may result in fire, electric shock or other hazards.

21. SAFETY CHECK

Upon completion of any service or repairs to this unit, ask the service technician to perform safety checks to determine that the unit is in proper operating condition.

22. HEAT

The product should be situated away from heat sources such as radiators, heat registers, stoves, or other products (including amplifiers) that produce heat.

23. CONNECTING

When you connect the product to other equipment, turn off the power and unplug all of the equipment from the wall outlet. Failure to do so may cause an electric shock and serious personal injury. Read the owner's manual of the other equipment carefully and follow the instructions when making any connections.

24. NOTE TO CABLE TV SYSTEM INSTALLER

This reminder is provided to call the Cable TV system installer's attention to Article 820-40 of the NEC that provides guidelines for proper grounding and, in particular, specifies that the cable ground shall be connected to the grounding system of the building, as close to the point of cable entry as practical.

25. DISCONNECTING

To disconnect the main POWER, you must unplug the power cord from the AC outlet. The power switch DOES NOT completely disconnect power.



Timer menu

Press the MENU button repeatedly to select the TIMER menu.

1. OFF-TIME

- Press P+ or P- button to select OFF-TIME option.
- Press V+ or V- button to set the frequency of timer: OFF, ONCE, EVERY
- Press P+ or P- button to select the sub-option of OFF-TIME.
- Press V+ or V- button to set the time set the time for the TV by minute, press and holding V+ or V- to set the time by ten-minute.

Note: This function will only work when OFF TIMER is not OFF and CLOCK is set.



2. ON-TIME

- Press P+ or P- button to select ON-TIME option.
- Press V+ or V- button to set the frequency of timer: OFF, ONCE, EVERY
- Press P+ or P- button to select the sub-option of ON-TIME.
- Press V+ or V- button to set the time set the time for the TV by minute, press and holding V+ or V- to set the time by ten-minute.

Note: This function will only work when OFF TIME is not OFF and CLOCK is set.



3. TV/CATV & CHANNEL

- Press P+ or P- button to select TV/CATV option then choose TV or CATV mode.
- Press P+ or P- button to select CHANNEL option.
- Press V+ or V- button to set the channel when TV on.
- The TV will display the selected channel when the TV is on.

Note: This function will only work when ON-TIME is set and CLOCK is set.

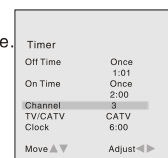

4. CLOCK

- Press P+ or P- button to select CLOCK option.
- Press V+ or V- button to set the time for the TV by minute, press and holding V+ or V- to set the time by ten-minute.

Note: Only when CLOCK is set, other options in this menu can be available.

Note: All the settings in this TIMER menu won't be saved when the TV set is shut down by power switch in front panel or power input-off.



THE CAUSES OF INTERFERENCE

Incorporated in your TV set is the most up-to-date technology to eliminate interference. Local radiation however, can create disturbances which in turn, can noticeably affect the picture. Proper installation and a good antenna are your best safeguards against these disturbances.

Interference

Moving ripples across the screen are caused by nearby transmitting or receiving shortwave radio equipment.

Diathermy

Herringbone pattern and partial picture loss can result from the operation of diathermy equipment from a nearby medical center or hospital.

Snow

Weak TV signals from long distant stations result in an unsteady picture and give the effect of falling snow. An antenna adjustment or antenna amplifier may be needed.

Ghost

Multiple images caused by TV signals reflected back from surrounding buildings, hills, aircraft, etc. are minimized by proper antenna positioning.

Car Ignition

Nearby cars and electrical motors can cause small streaks across the picture or make the picture roll.

OPERATION OF MAIN MENU

When pressing Menu button, TV displays the following menus in turn:

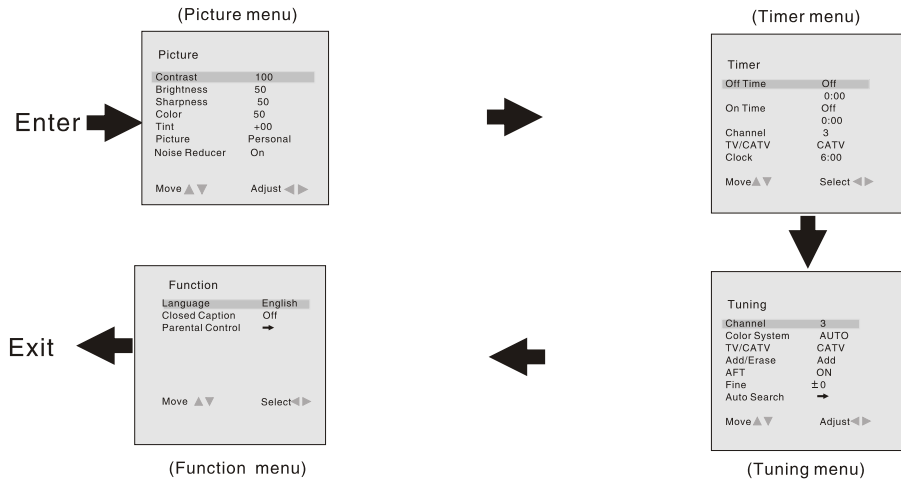

Picture menu

1. Press the MENU button repeatedly to select the PICTURE menu.
2. Press P+ or P- button to select the BRIGHT option, when the option is selected, the background color of this option is different from others.
3. Press V+ or V- button to adjust/select the value.
4. In the same way, the values of other options can be adjusted/selected.

😊 Note: When the BACKGROUND is ON, the screen will be blue without signal input.





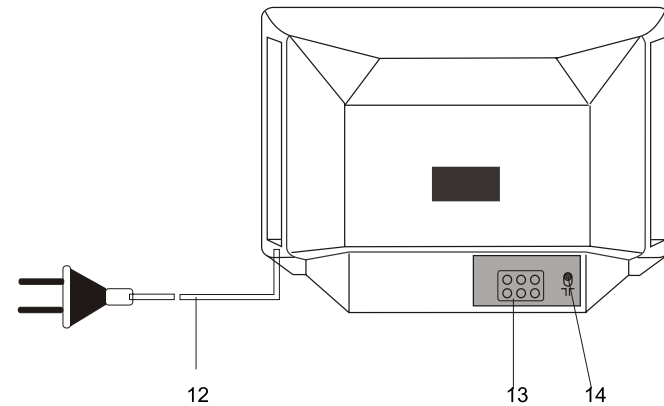
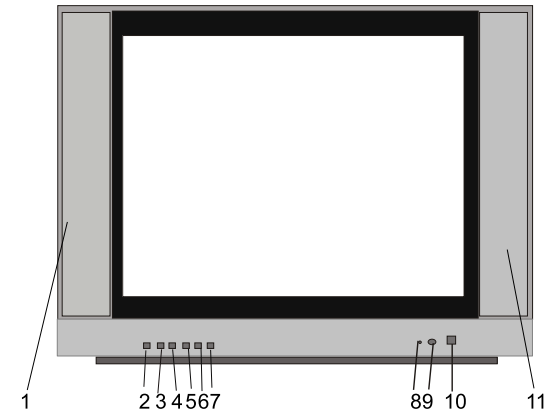



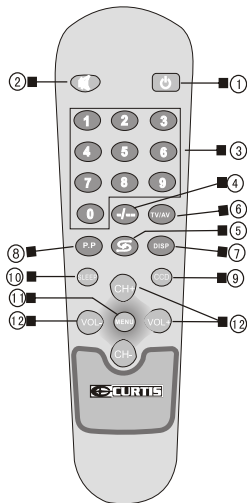



LOCATION & FUNCTION OF CONTROL PANEL

1. Speaker
2. TV/AV Selector
3. Menu Button
4. Volume Down Button
5. Volume Up Button
6. Channel Down Button
7. Channel Up Button
8. Power Indicator
9. Remote Sensor
10. Main Power Switch
11. Speaker
12. AC power Cord
13. Audio/Video-input and output jacks
14. Antenna terminal (75 ohms)



LOCATION & FUNCTION OF REMOTE CONTROL



<p>1. POWER SWITCH</p>  <p>When press this button, TV switches on from the state of STANDBY. When press this button again, TV will turn back to the state of STANDBY.</p>	<p>2. MUTE BUTTON</p>  <p>When press this button, the sound will be muted, press it again, the sound will resume.</p>
<p>3. CHANNEL-CHOOSING BUTTON (0-9)</p>  <p>Press any digit button to choose a channel. (0-9)</p>	<p>4. TWO OR THREE DIGITS BUTTON</p>  <p>When press the two or three digit button, the screen displays --/-- then enter the digits of the channel you want.</p>
<p>5. REVIEW BUTTON</p>  <p>When press this button, the current channel will return to the one you watch last time.</p>	<p>6. TV/AV SWITCH BUTTON(TV/AV)</p>  <p>When press this button, the TV and AV state can switch from each other.</p>
<p>7.DISPLAY BUTTON(LOCK)</p>  <p>When press this button, some information will display on the screen, such as color system, channel No.. Pressing this button for 4 seconds to lock the current channel, repeat it again to unlock it.</p>	<p>8. PICTURE MODE BUTTON</p>  <p>When press this button, you can select the one of the five modes as the following order: STANDARD, MILD, VIVID, DYNAMIC, PERSONAL.</p>
<p>9. CCD BUTTON</p>  <p>When press this button, you can select CCD on or CCD off</p>	<p>10.SLEEP BUTTON</p>  <p>When press this button, you can set the sleep timer as the follows: OFF-120-110-100.....10</p>
<p>11. MAIN MENU BUTTON</p>  <p>When press this button, you can enter the MENU. (see page 6 for detail.)</p>	<p>12. CHANNEL AND VOLUME BUTTON</p>  <p>When press this button, you can choose the channel up or down, you may also adjust the volume up or down.</p>

Step 6 Automatic channel preset

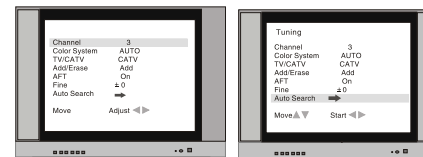

1. Press the MENU button times to select the TUNNING menu.
2. Press P+ or P- button and let the arrow point to AUTO-SEARCH.
3. Press V+ button to start searching the channels automatically.
4. After search and memorise finishing, the channel number "0" will be displayed at the upright of the screen, then you can enjoy your watching.



- ☺ NOTES: 1. All the available channels will be memory automatically while the auto-search finishes.
2. You can also use the remote control to finish this operation.
3. If you want to set the channels by yourself, see page 8 for more detail.

Step 7 Now it is ready for watching

Are you ready now.....

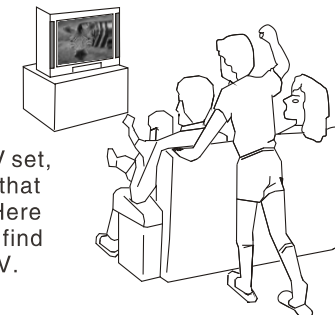

To enjoy the full features of your TV set, please read this manual carefully so that you can operation this set skillfully. Here is some tips in the following, you can find out more during your life with color TV.

Step 8 Some useful tips to you

- ☺ This TV set can memorize 181 channels.
- ☺ This TV has the function that displays the blue background with no noise.
- ☺ This TV has the function that switch off automatically. (after the signal disable for ten minutes the TV will switch off automatically and stay the stage of standby)
- ☺ In case that electricity is cut when watching TV, switch off the power. If you finish watching TV, please switch off the power. (ref. the picture 1) Not just press the POWER button on the remote control.
- ☺ If you don't watch TV for a long time or you are going to away from home, Please pull the plug from the socket. (ref. the picture 2)
- ☺ To protect your eyes, the least distance of watching TV is 3 times of the diagonal of the screen. (ref. Picture 3)

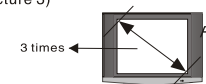

PREPARATION

Step 1 Connect to the antenna

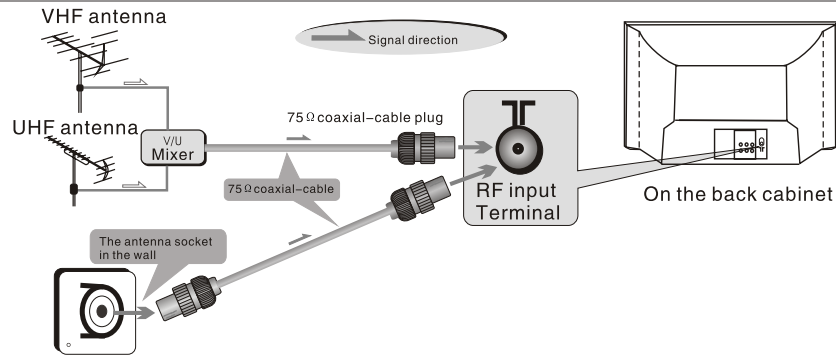

Step 2 Connect to the audio/video equipment

Audio/Video equipment can be connected to sockets of Audio input/output and Video input/output.

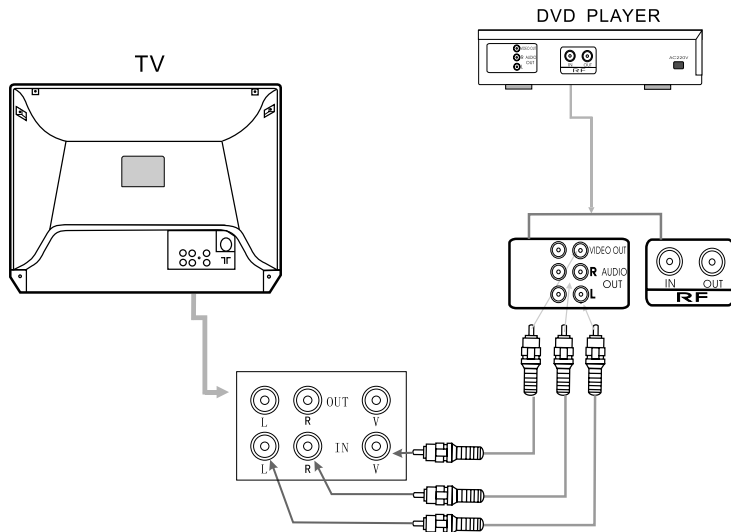

6

Step 3 Connect to the Power

Insert the power cord plug to the socket

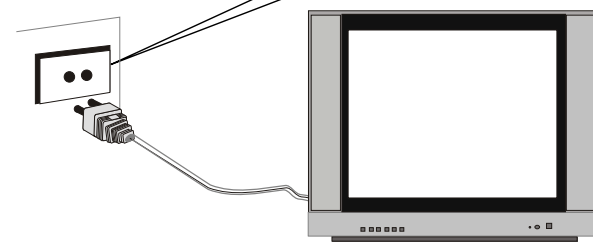

Step 4 Battery installation(remote control unit)

- 1.Remove the battery cover
 - 2.Insert 2x1.5V AAA batteries making sure the polarity(+ or-)of the batteries matches the polarity marks inside the unit.
 - 3.Replace the battery.
- Replace the batteries when the TV begins to show the following symptoms: operation is unsteady or erratic, sometimes the TV set doesn't function by remote control .

☺ NOTES:

- 1)Alkaline batteries are recommended
- 2)Remove batteries when they are exhausted or if the remote controller is not to be used for in a long time.
- 3)Never combine the new battery with the used one .



Step 5 Turn on the TV

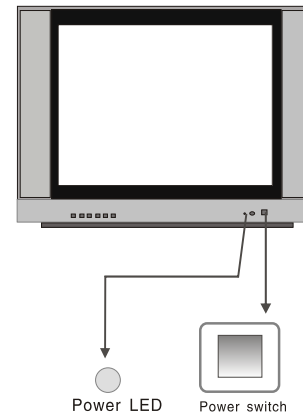

1. Plug the power cord into the wall socket, power LED lights up at stand by mode.
2. Press the POWER switch to turn on/off the power.

7

Free Manuals Download Website

<http://myh66.com>

<http://usermanuals.us>

<http://www.somanuals.com>

<http://www.4manuals.cc>

<http://www.manual-lib.com>

<http://www.404manual.com>

<http://www.luxmanual.com>

<http://aubethermostatmanual.com>

Golf course search by state

<http://golfingnear.com>

Email search by domain

<http://emailbydomain.com>

Auto manuals search

<http://auto.somanuals.com>

TV manuals search

<http://tv.somanuals.com>