



VoIP Singlewire-enabled Ceiling Speaker Operations Guide

Part Number
011102*, RAL 9002, Gray White, Standard
011103, RAL 9003, Signal White, Optional
*Replaces the 011065 number.

Document Part #930320C
for Firmware Version 1.2.1

CyberData Corporation
2555 Garden Road
Monterey, CA 93940
(831) 373-2601

VoIP Singlewire-enabled Ceiling Speaker Operations Guide 930320C

Part

011102*, RAL 9002, Gray White, Standard

011103, RAL 9003, Signal White, Optional

*Replaces the 011065 number.

COPYRIGHT NOTICE:

© 2010, CyberData Corporation, ALL RIGHTS RESERVED.

This manual and related materials are the copyrighted property of CyberData Corporation. No part of this manual or related materials may be reproduced or transmitted, in any form or by any means (except for internal use by licensed customers), without prior express written permission of CyberData Corporation. This manual, and the products, software, firmware, and/or hardware described in this manual are the property of CyberData Corporation, provided under the terms of an agreement between CyberData Corporation and recipient of this manual, and their use is subject to that agreement and its terms.

DISCLAIMER: Except as expressly and specifically stated in a written agreement executed by CyberData Corporation, CyberData Corporation makes no representation or warranty, express or implied, including any warranty or merchantability or fitness for any purpose, with respect to this manual or the products, software, firmware, and/or hardware described herein, and CyberData Corporation assumes no liability for damages or claims resulting from any use of this manual or such products, software, firmware, and/or hardware. CyberData Corporation reserves the right to make changes, without notice, to this manual and to any such product, software, firmware, and/or hardware.

OPEN SOURCE STATEMENT: Certain software components included in CyberData products are subject to the GNU General Public License (GPL) and Lesser GNU General Public License (LGPL) "open source" or "free software" licenses. Some of this Open Source Software may be owned by third parties. Open Source Software is not subject to the terms and conditions of the CyberData COPYRIGHT NOTICE or software licenses. Your right to copy, modify, and distribute any Open Source Software is determined by the terms of the GPL, LGPL, or third party, according to who licenses that software.

Software or firmware developed by CyberData that is unrelated to Open Source Software is copyrighted by CyberData, subject to the terms of CyberData licenses, and may not be copied, modified, reverse-engineered, or otherwise altered without explicit written permission from CyberData Corporation.

TRADEMARK NOTICE: CyberData Corporation and the CyberData Corporation logos are trademarks of CyberData Corporation. Other product names, trademarks, and service marks may be the trademarks or registered trademarks of their respective owners.



Phone: (831) 373-2601
Technical Support Ext. 333
support@cyberdata.net
Fax: (831) 373-4193
Company and product information at www.cyberdata.net

Revision History

Revision	Date Released	Description of Changes
A	12/18/2009	This is the first release of the manual.
B	5/27/2010	Adds information about the following 01 numbers: 011102*, RAL 9002, Gray White, Standard 011103, RAL 9003, Signal White, Optional *Replaces the 011065 number.
C	6/25/2010	Updates firmware version to 1.2.1. Updates Figure 2-6, "Running the V2 Speaker with Auxiliary Power" with new 01 part numbers for the auxiliary speaker.

Important Safety Instructions

1. Read these instructions.
2. Keep these instructions.
3. Heed all warnings.
4. Follow all instructions.
5. Do not use this apparatus near water.
6. Clean only with dry cloth.
7. Do not block any ventilation openings. Install in accordance with the manufacturer's instructions.
8. Do not install near any heat sources such as radiators, heat registers, stoves, or other apparatus (including amplifiers) that produce heat.
9. Do not defeat the safety purpose of the polarized or grounding-type plug. A polarized plug has two blades with one wider than the other. A grounding type plug has two blades and a third grounding prong. The wide blade or the third prong are provided for your safety. If the provided plug does not fit into your outlet, consult an electrician for replacement of the obsolete outlet.
10. Protect the power cord from being walked on or pinched particularly at plugs, convenience receptacles, and the point where they exit from the apparatus.
11. Only use attachments/accessories specified by the manufacturer.
12. Refer all servicing to qualified service personnel. Servicing is required when the apparatus has been damaged in any way, such as power-supply cord or plug is damaged, liquid has been spilled or objects have fallen into the apparatus, the apparatus has been exposed to rain or moisture, does not operate normally, or has been dropped.
13. Prior to installation, consult local building and electrical code requirements.



GENERAL ALERT

Warning

Electrical Hazard: This product should be installed by a licensed electrician according to all local electrical and building codes.





GENERAL ALERT

Warning

Electrical Hazard: To prevent injury, this apparatus must be securely attached to the floor/wall in accordance with the installation instructions.

Pictorial Alert Icons

	<p>General Alert</p> <p><i>This pictorial alert indicates a potentially hazardous situation. This alert will be followed by a hazard level heading and more specific information about the hazard.</i></p>
	<p>Ground</p> <p><i>This pictorial alert indicates the Earth grounding connection point.</i></p>

Hazard Levels

Danger: Indicates an imminently hazardous situation which, if not avoided, will result in death or serious injury. This is limited to the most extreme situations.

Warning: Indicates a potentially hazardous situation which, if not avoided, could result in death or serious injury.

Caution: Indicates a potentially hazardous situation which, if not avoided, could result in minor or moderate injury. It may also alert users against unsafe practices.

Notice: Indicates a statement of company policy (that is, a safety policy or protection of property).

The safety guidelines for the equipment in this manual do not purport to address all the safety issues of the equipment. It is the responsibility of the user to establish appropriate safety, ergonomic, and health practices and determine the applicability of regulatory limitations prior to use. Potential safety hazards are identified in this manual through the use of words **Danger**, **Warning**, and **Caution**, the specific hazard type, and pictorial alert icons.

Abbreviations and Terms

Abbreviation or Term	Definition
A-law	A standard companding algorithm, used in European digital communications systems to optimize, i.e., modify, the dynamic range of an analog signal for digitizing.
AVP	Audio Video Profile
Cat 5	TIA/EIA-568-B Category 5
DHCP	Dynamic Host Configuration Protocol
LAN	Local Area Network
LED	Light Emitting Diode
Mbps	Megabytes per Second.
NTP	Network Time Protocol
PBX	Private Branch Exchange
PoE	Power over Ethernet (as per IEEE 802.3af standard)
RTP	Real-time Transport Protocol
RTFM	Reset Test Function Management
Talkback	Two-way communication enabled
TFTP	Trivial File Transfer Protocol
u-law	A companding algorithm, primarily used in the digital telecommunication
UC	Unified Communications
VoIP	Voice over Internet Protocol

Contents

Chapter 1 Product Overview	1
1.1 How to Identify This Product	2
1.2 Installation	3
1.3 Product Features	3
1.4 Supported Protocols	4
1.5 Product Specifications	4
1.6 Dimensions	5
Chapter 2 Installing the Singlewire-enabled Speaker	6
2.1 Parts List	6
2.2 Device Configuration	7
2.2.1 Connect Power to the Speaker	7
2.2.2 Installation Options	10
2.2.3 Confirm that the Speaker is Operational and Linked to the Network	12
2.2.4 Confirm the IP Address, Test the Audio, and Check the Volume	13
2.2.5 Adjust the Volume	14
2.2.6 How to Set the Factory Default Settings	15
2.3 Configure the Speaker Parameters	16
2.3.1 Log in to the Configuration Home Page	17
2.4.1 Reboot the Singlewire-enabled Speaker	22
2.5 Identifying and Testing a Ceiling Speaker when Using InformaCast 4.0 or Later	23
Appendix A Mounting the Speaker	29
A.1 Mount the Speaker	29
Appendix B Setting up a TFTP Server	32
B.1 Set up a TFTP Server	32
B.1.1 In a LINUX Environment	32
B.1.2 In a Windows Environment	32
Appendix C Troubleshooting/Technical Support	33
C.1 Frequently Asked Questions (FAQ)	33
C.2 Documentation	33
C.3 Contact Information	34
C.4 Warranty	34
C.4.1 Warranty & RMA Returns within the United States	35
C.4.2 Warranty & RMA Returns Outside of the United States	35
C.4.3 Spare in the Air Policy	35
C.4.4 Return and Restocking Policy	35
C.4.5 Warranty and RMA Returns Page	35
Index	36

1 Product Overview

The CyberData Singlewire-enabled Speaker is a Power-over-Ethernet (PoE 802.3af) and Voice-over-IP (VoIP) public address loudspeaker that easily connects into existing local area networks with a single CAT5 cable connection. The speaker is compatible with Singlewire's InformaCast software. Its small footprint and low height allows the speaker to be discretely mounted almost anywhere.

Note The version of InformaCast needs to be 4.0 or higher.

Note Prior to installation, create a plan for the locations of your speakers.



GENERAL ALERT

General Alert

Consult local building and electrical code requirements prior to installation.

1.1 How to Identify This Product

To identify the VoIP Singlewire-enabled Ceiling Speaker, look for a model number label similar to the one shown in [Figure 1-1](#). The model number on the label should be one of the following:

- **011102***, RAL 9002, Gray White, Standard Color
- **011103**, RAL 9003, Signal White, Optional Color

*Replaces 011065.

Figure 1-1. Model Number Label

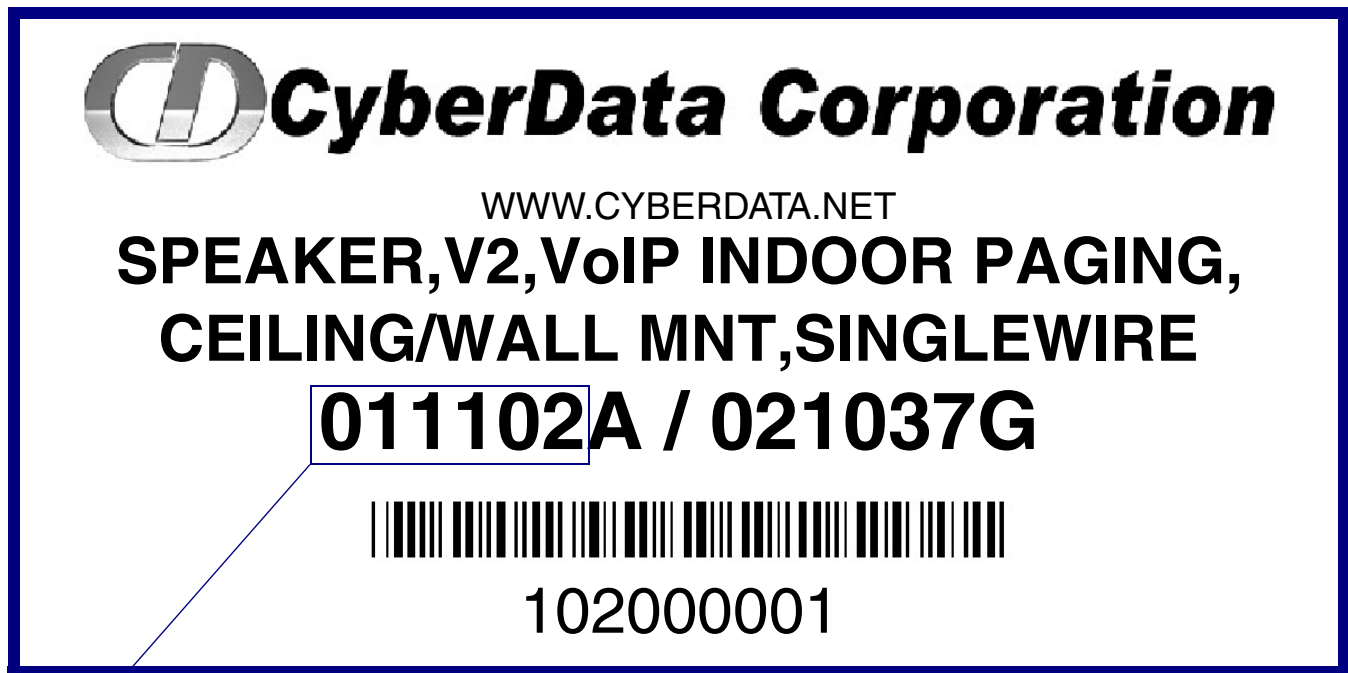

Model number

1.2 Installation

Figure 1-2 illustrates a typical configurations for the Singlewire-enabled Speaker.

Figure 1-2. Typical Installation

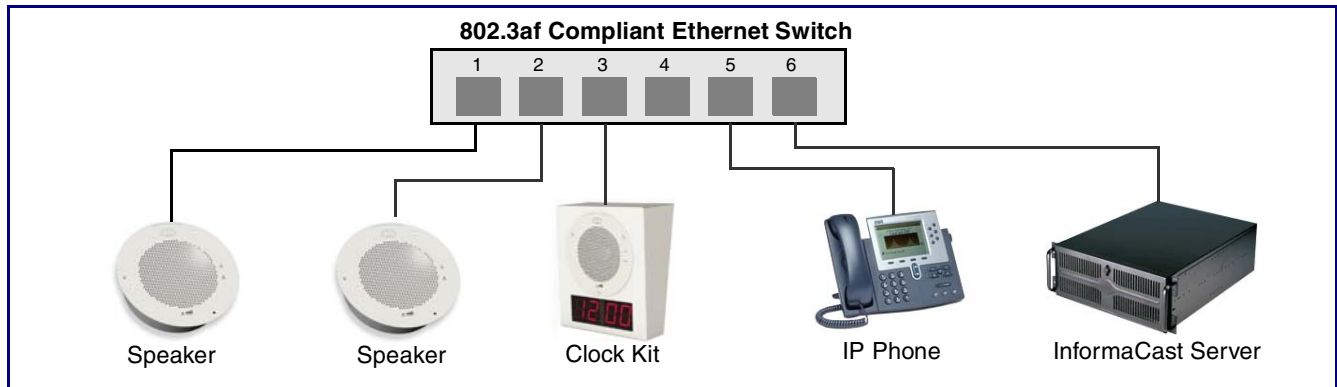

See the following sections for other installation options:

- [Section 2.2.1.3, "Running the Singlewire-enabled Speaker with Auxiliary Power"](#)
- [Section 2.2.2.1, "Singlewire-enabled Speaker with Extra Speaker Connection"](#)
- [Section 2.2.2.2, "Singlewire-enabled Speaker with Line Out"](#)

1.3 Product Features



- *Web-based firmware upgradeable*
- *Small footprint*
- *High efficiency speaker driver*
- *PoE 802.3af Enabled (Powered-over-Ethernet)*
- *Network and external speaker volume control*
- *Auto detect for CyberData Clock kit*

1.4 Supported Protocols

The Singlewire-enabled Speaker supports:

- Multicast
- DHCP Client
Dynamically assigns IP addresses in addition to the option to use static addressing.
- InformaCast Version 4.0 and greater
- TFTP Client
Facilitates Web-based firmware upgrades of the latest speaker capabilities.
- RTP
- Audio Encodings
PCMU (G.711 mu-law)
PCMA (G.711 A-law)
Packet Time 20 ms

1.5 Product Specifications

Category	Specification
Sensitivity	96dB/1W/1M S.P. Level
Output	10 Watts Peak Power
Operating temperature	-30 to 55 C (-22 to 131 F)
Port baud rate	10/100 Mbps
Protocol	Singlewire InformaCast 4.0 and higher
Power Input	PoE 802.3af (as per IEEE 802.3af standard from a UL listed power source)
Payload types	G711, A-law and μ -law
Regulatory compliance	FCC Class B, CE
Warranty	2 years limited
Dimensions	9" x 2.4"
Weight	2.8 lbs./shipping weight of 3.8 lbs. (1.3 kg/shipping weight of 1.7 kg)
Part number	011102

1.6 Dimensions

Figure 1-3 shows the dimensions for the Singlewire-enabled Speaker.

Figure 1-3. Dimensions

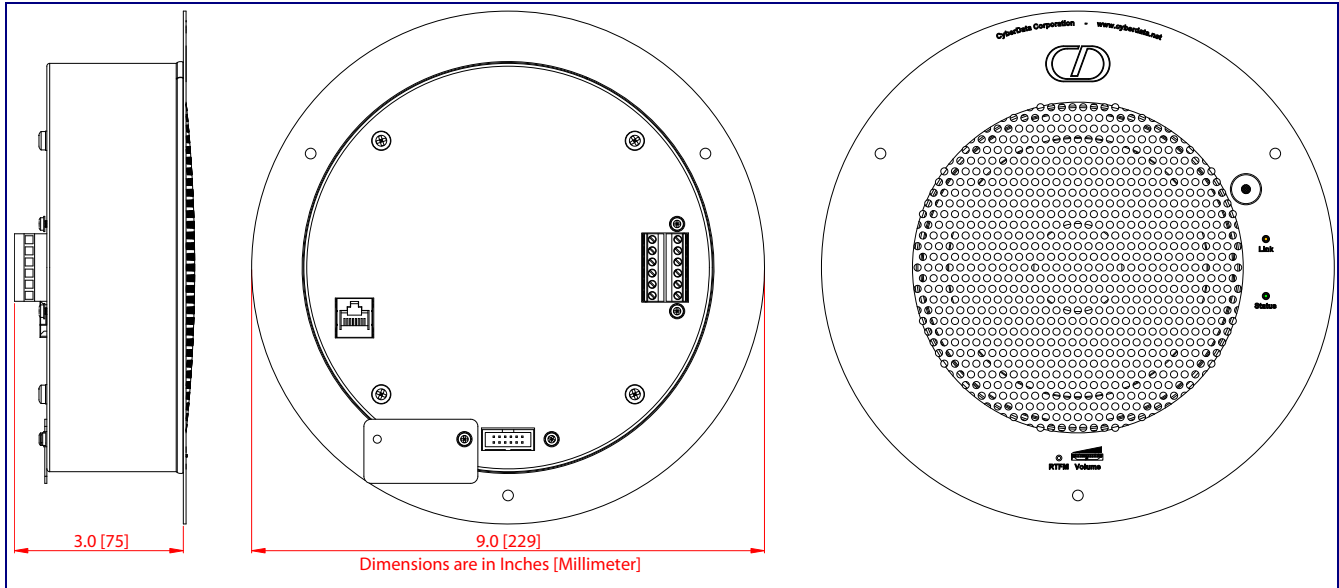



2 Installing the Singlewire-enabled Speaker

2.1 Parts List

Table 2-1 illustrates the parts for each speaker and includes kits for the drop ceiling and drywall mounting.

Note The installation template for the Singlewire-enabled Speaker is located on the *Installation Quick Reference Guide* that is included in the packaging with each speaker.

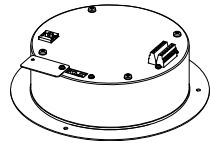
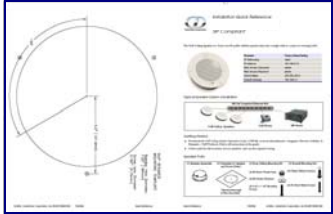
Table 2-1. Parts

Quantity	Part Name	Illustration
1	Singlewire-enabled Speaker Assembly	
1	Installation Quick Reference Guide	
1	Speaker Mounting Accessory Kit (Part #070054A)	

2.2 Device Configuration

Set up and configure each speaker *before* you mount it.

CyberData delivers each speaker with the following factory default values:

Table 2-2. Factory Network Default Settings—Default of Network

Parameter	Factory Default Setting
IP Addressing	DHCP
IP Address ^a	10.10.10.10
Web Access Username	admin
Web Access Password	admin
Subnet Mask ^a	255.0.0.0
Default Gateway ^a	10.0.0.1

a. Default if there is not a DHCP server present.

2.2.1 Connect Power to the Speaker

Figure 2-4 through Figure 2-6 illustrates how to connect power to the Singlewire-enabled Speaker.

2.2.1.1 Singlewire-enabled Speaker to a 802.3af Compliant PoE Switch

Figure 2-4 illustrates how to connect the Singlewire-enabled Speaker to a 802.3af compliant PoE switch via a Cat 5 Ethernet cable.

Figure 2-4. Singlewire-enabled Speaker to a 802.3af Compliant PoE Switch

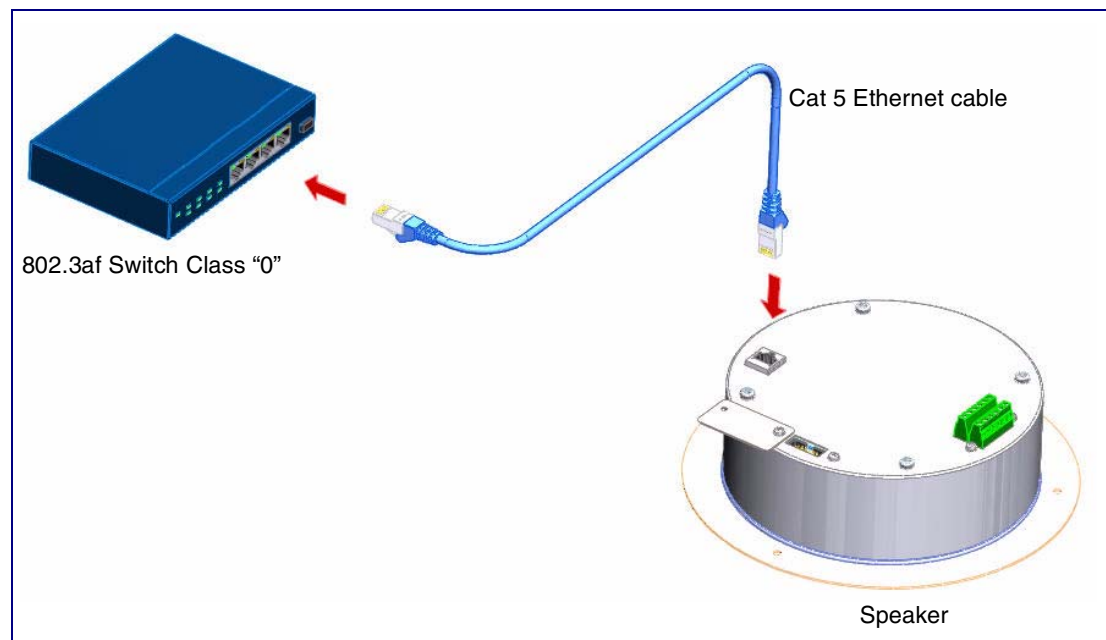

2.2.1.2 Singlewire-enabled Speaker (with PoE Injector) to a 802.3af Compliant PoE Switch

In [Figure 2-5](#), if a PoE switch is not available, you will need a PoE Injector, part #010867A (ordered separately). A PoE Injector is a power supply solution for those who have a standard Non PoE Switch.

Figure 2-5. Singlewire-enabled Speaker (with PoE Injector) to a Non PoE Switch

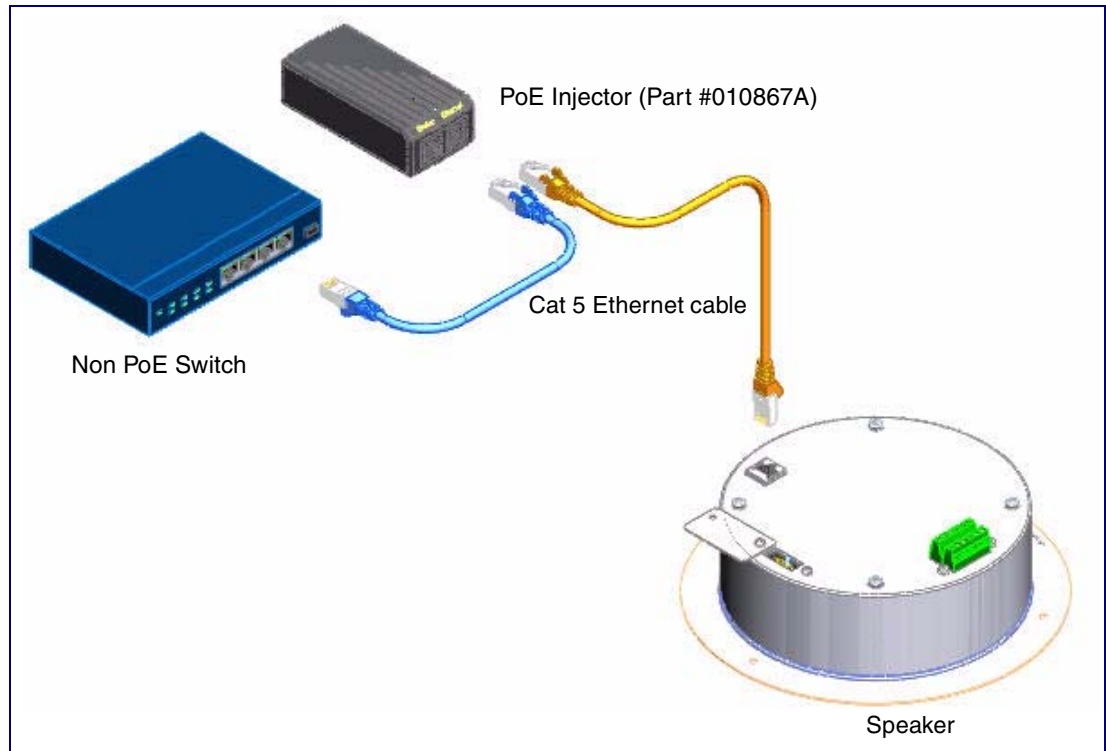

2.2.1.3 Running the Singlewire-enabled Speaker with Auxiliary Power

In [Figure 2-6](#), the power for the Singlewire-enabled Speaker can either come from an 802.3af Network connection or from an external source.

Figure 2-6. Running the V2 Speaker with Auxiliary Power

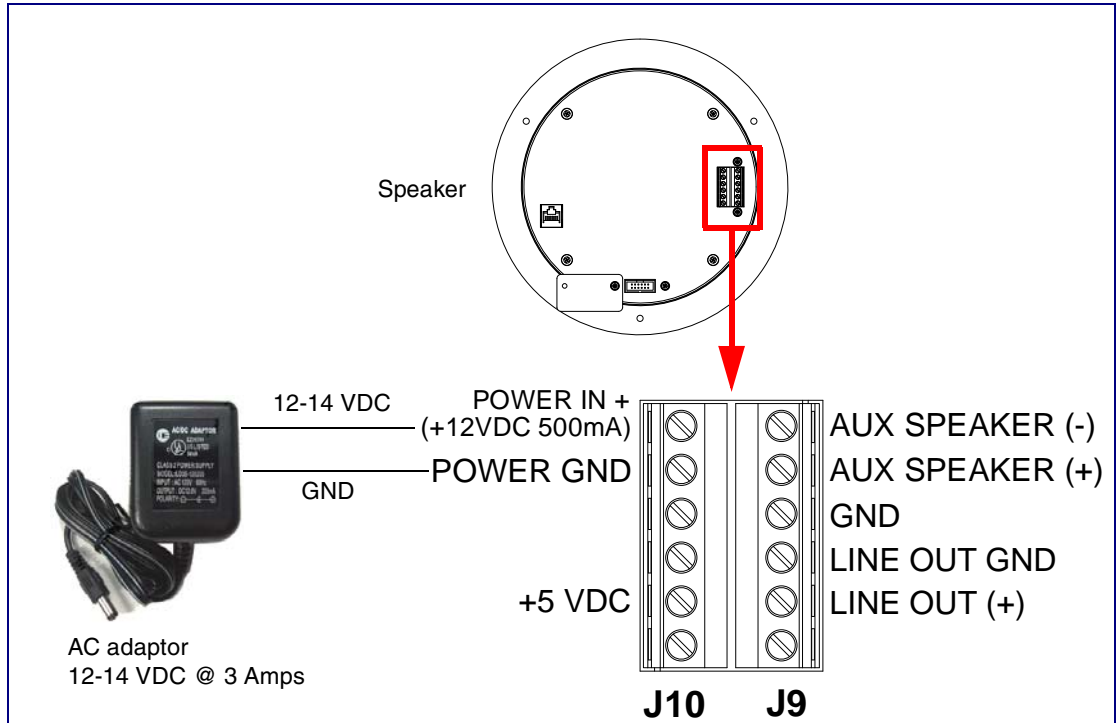

2.2.2 Installation Options

Figure 2-7 through Figure 2-8 illustrates various installation options for the Singlewire-enabled Speaker.

2.2.2.1 Singlewire-enabled Speaker with Extra Speaker Connection

In Figure 2-7, the Singlewire-enabled Speaker supports an amplified audio output for a second analog speaker. While the total speaker wattage is the same, by connecting a low cost analog speaker, additional coverage can be realized.

Speaker Setup When using the second speaker connection, the digital volume control needs to be set to less than level 8 while making pages. Some adjustment of this value may be required depending on the specific PoE switch.

Figure 2-7. Singlewire-enabled Speaker with Extra Speaker Connection

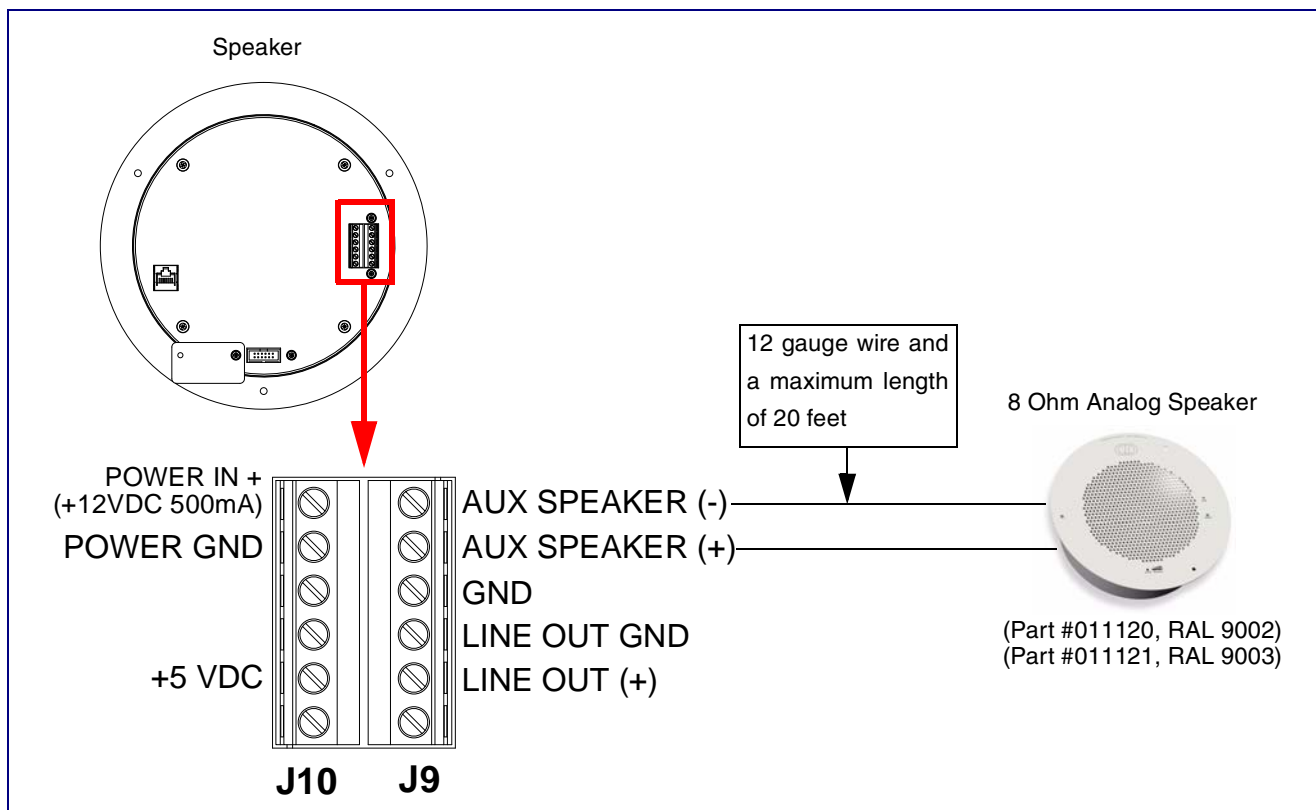

2.2.2.2 Singlewire-enabled Speaker with Line Out

In [Figure 2-8](#), for areas that require more speaker volume, the Singlewire-enabled Speaker can be connected directly to an auxiliary amplifier to drive additional horns or speakers. This is done through the line-out connection.

Figure 2-8. Singlewire-enabled Speaker with Line Out

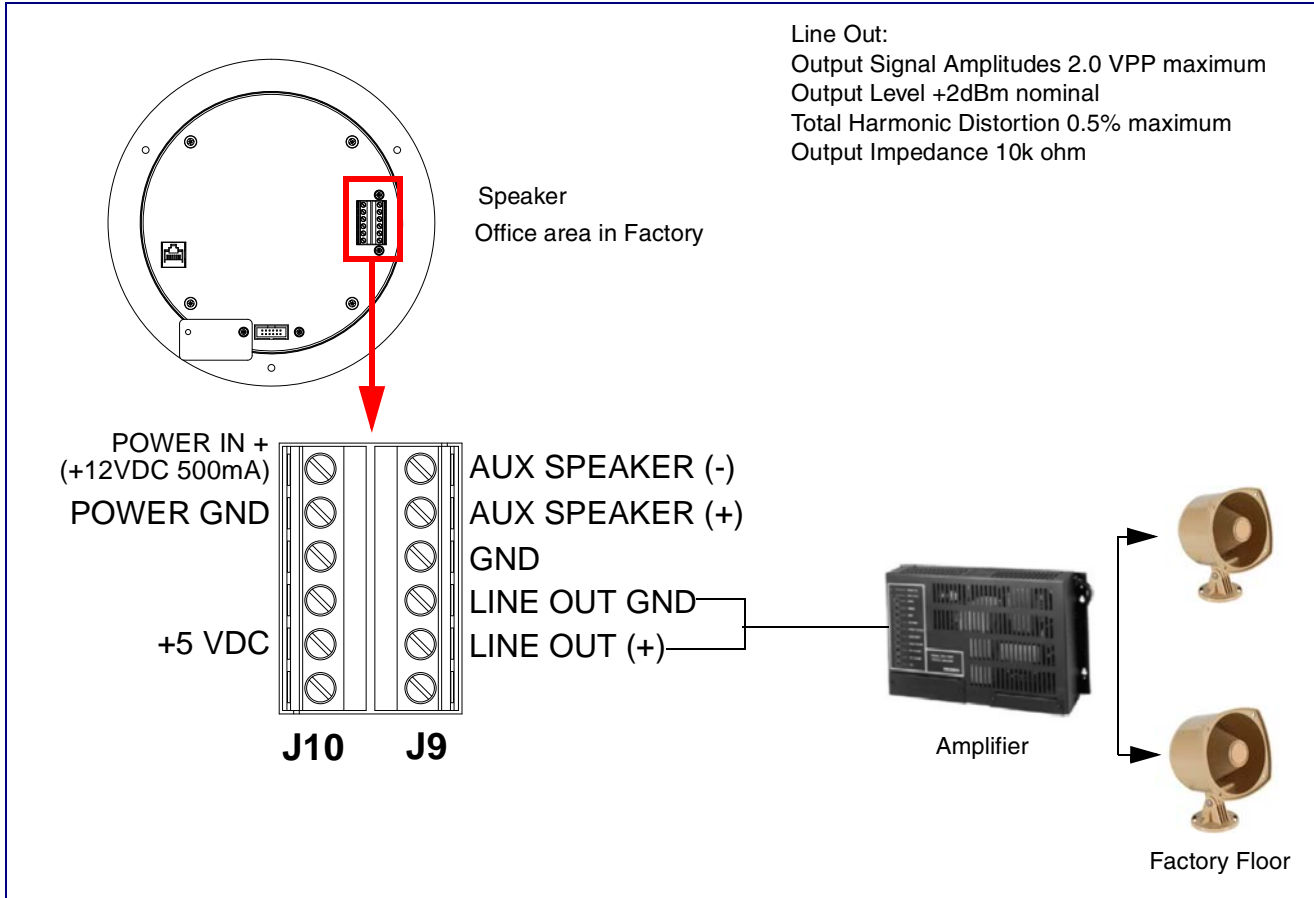

2.2.3 Confirm that the Speaker is Operational and Linked to the Network

After connecting the speaker to the 802.3af compliant Ethernet hub, the LEDs on the speaker face confirm that the speaker is operational and linked to the network.

Figure 2-9. Status and Activity LEDs

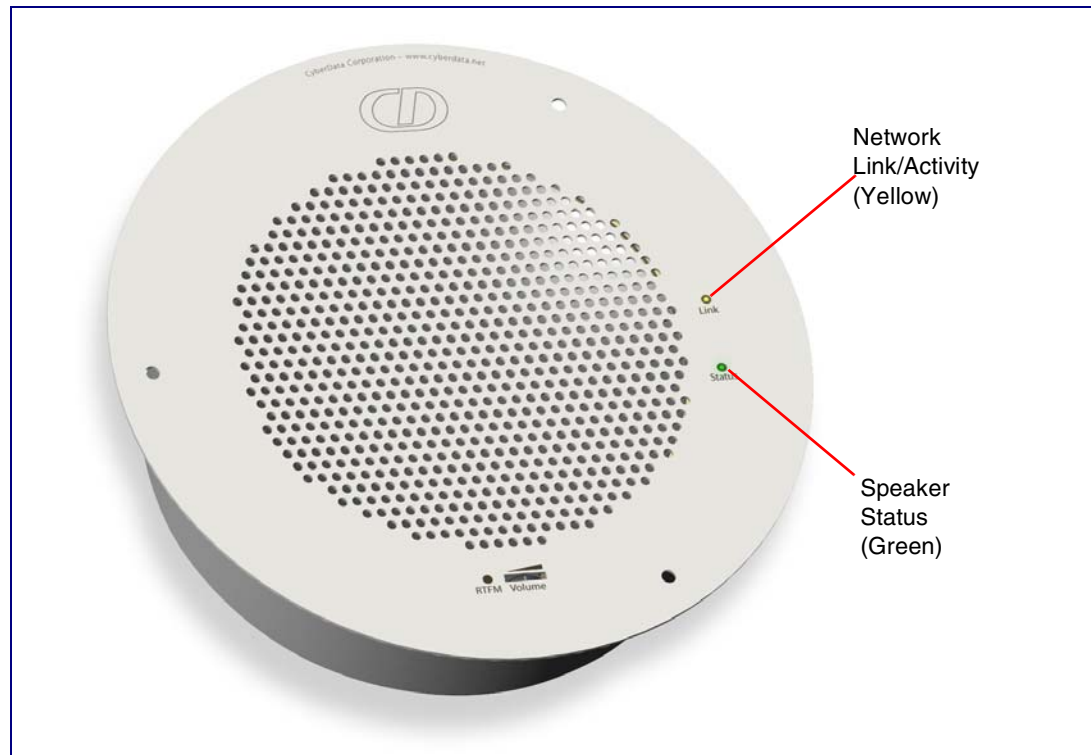

2.2.3.1 Status LED

After supplying power to the speaker:

1. The green power/status LED and the yellow network LED comes on immediately.
2. After about 23 seconds with a static IP address (or 27 seconds if the board is set to use DHCP), the green LED will blink twice to indicate that the board is fully booted.

Note If the board is set to use DHCP and there is not a DHCP server available on the network, it will try five times with a three second delay between tries and eventually fall back to the programmed static IP address (by default 10.10.10.10). This process will take approximately 80 seconds.

2.2.3.2 Link LED

- The **Link** LED is illuminated when the network link to the speaker is established.
- The **Link** LED blinks to indicate network traffic.

2.2.4 Confirm the IP Address, Test the Audio, and Check the Volume

2.2.4.1 Reset Test Function Management (RTFM) Switch

When the speaker is operational and linked to the network, use the Reset Test Function Management (RTFM) switch (Figure 2-10) on the speaker face to announce and confirm the speaker's IP Address, test that the audio is working, and check the volume.

Figure 2-10. RTFM Switch



To announce a speaker's current IP address:

1. Press and release the RTFM switch within a five second window.
2. When you hear the IP address announcement, check the speaker volume.

Note The speaker will use DHCP to obtain the new IP address (DHCP-assigned address or default to 10.10.10.10 if a DHCP server is not present).

Note Pressing and holding the RTFM switch for longer than five seconds will restore the speaker to the factory default settings.

2.2.5 Adjust the Volume

To adjust the speaker volume, turn the **Volume** control dial (Figure 2-11) on the speaker face.

Note The Singlewire-enabled Speaker has two volume controls: **Networked-based** (as controlled by the Singlewire protocol from InformaCast) and **External** (volume knob).

Figure 2-11. Volume Control

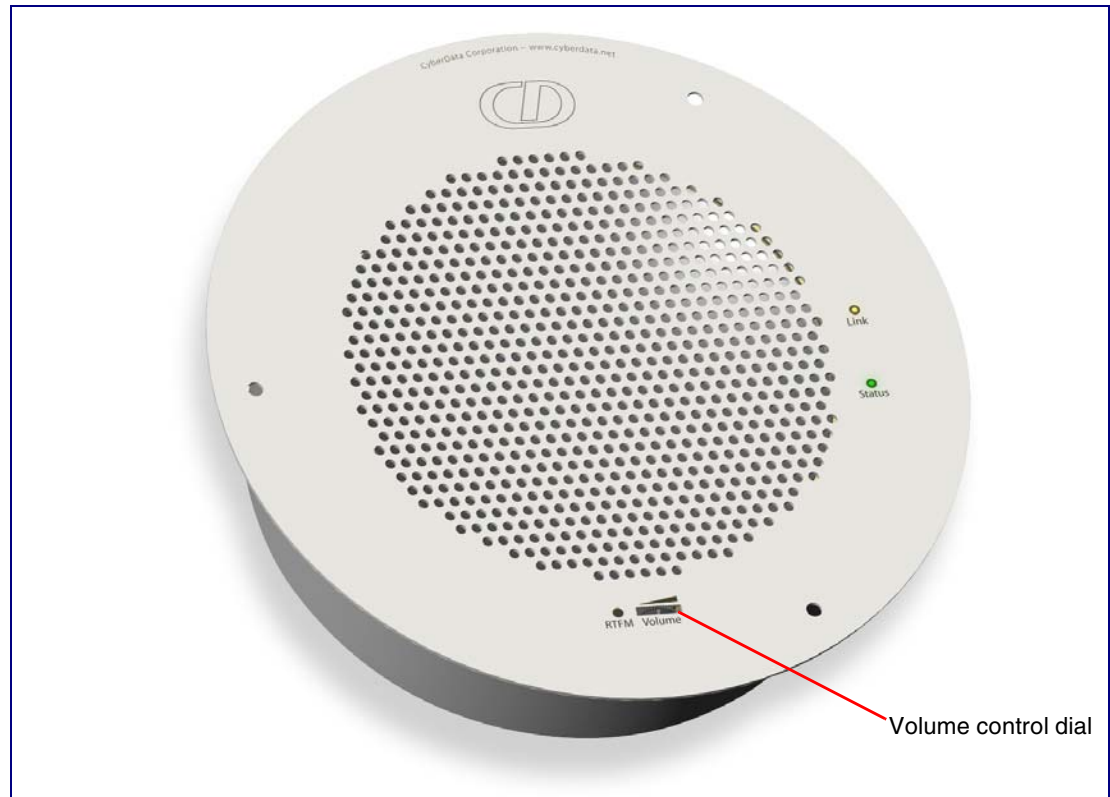

2.2.6 How to Set the Factory Default Settings

2.2.6.1 RTFM Switch

When the speaker is operational and linked to the network, use the Reset Test Function Management (RTFM) switch (Figure 2-12) on the speaker face to set the factory default settings.

Figure 2-12. RTFM Switch



To set the factory default settings:

1. Press and hold the **RTFM** switch for more than five seconds.
2. The speaker announces that it is restoring the factory default settings.

Note The speaker will use DHCP to obtain the new IP address (DHCP-assigned address or default to 10.10.10.10 if a DHCP server is not present).

2.3 Configure the Speaker Parameters

To configure the speaker online, use a standard web browser.

Configuration of the speaker is taken care of by the InformaCast server. If an InformaCast server can not be found, the speaker will return to factory defaults as shown in [Table 2-3](#).

Table 2-3. Factory Network Default Settings—Default of Network

Parameter	Factory Default Setting
IP Addressing	DHCP
IP Address ^a	10.10.10.10
Web Access Username	admin
Web Access Password	admin
Subnet Mask ^a	255.0.0.0
Default Gateway ^a	10.0.0.1

a. Default if there is not a DHCP server present.

2.3.1 Log in to the Configuration Home Page

1. Open your browser to the Singlewire-enabled Speaker IP address. This can be found within the InformaCast Server Test Menu.

Note If the network does not have access to a DHCP server, the device will default to an IP address of 10.10.10.10.

Note Make sure that the PC is on the same IP network as the Singlewire-enabled Speaker.

2. When prompted, use the following default **Web Access Username** and **Web Access Password** to access the **Home Page** (Figure 2-13):

Web Access Username: **admin**

Web Access Password: **admin**

Figure 2-13. Home Page





The screenshot shows the 'Cyberdata Singlewire Speaker' configuration page. On the left, there are two buttons: 'Home' and 'Update Firmware'. The main content area is divided into two sections: 'Device Settings' and 'Current Settings'. The 'Device Settings' section contains three input fields: 'Change Username' (with 'admin' entered), 'Change Password', and 'Re-enter Password'. The 'Current Settings' section displays various system parameters. At the bottom of the settings area, there are 'Save' and 'Reboot' buttons.

Device Settings	
Change Username:	admin
Change Password:	
Re-enter Password:	

Current Settings	
Serial Number:	123456789
Mac Address:	00:20:f7:ff:cb:bc
Firmware Version:	v1.1.4
IP Addressing:	dhcp
IP Address:	10.10.0.205
Subnet Mask:	255.0.0.0
DNS Server 1:	68.87.76.178
DNS Server 2:	
Boot Time:	2009/12/17 13:40:46
Current Time:	2009/12/17 13:42:20
InformaCast Server:	10.0.1.95
Configuration File:	InformaCastSpeaker.cfg
B'casts Accepted:	0
B'castss Rejected:	0
B'casts Active:	0
RTP Packets Rx'd:	0
Clock Status:	INSTALLED
Clock Firmware:	v1.1.4

3. On the **Home Page**, review the setup details and navigation buttons described in [Table 2-4](#).

Table 2-4. Home Page Overview

Web Page Item	Description
Device Settings	
Change Username	Type in this field to change the username (25 character limit).
Change Password	Type in this field to change the password (19 character limit).
Re-enter Password	Type the password again in this field to confirm the new password (19 character limit).
Current Settings	
Serial Number	Shows the device serial number.
Mac Address	Shows the device Mac address.
Firmware Version	Shows the current firmware version.
IP Addressing	Shows the current IP addressing setting (DHCP or Static).
IP Address	Shows the current IP address.
Subnet Mask	Shows the current subnet mask address.
DNS Server 1	Shows the current DNS Server 1 address.
DNS Server 2	Shows the current DNS Server 2 address.
Boot Time	Shows the boot time.
Current Time	Shows the current time.
InformaCast Server	Shows the InformaCast Server IP address.
Configuration File	Shows the configuration file.
B'casts Accepted	Shows the number of B'casts accepted.
B'casts Rejected	Shows the number of B'casts rejected.
B'casts Rejected	Shows the number of active B'casts.
RTP Packets Rx'd	Shows the number of RTP packets Rx'd.
Clock Status	Shows the current clock status.
Clock Firmware	Shows the current clock firmware version.
	Link to the Home page.
	Link to the Update Firmware page.
	Click the Save button to save your configuration settings. Note: You need to reboot for changes to take effect.
	Click on the Reboot button to reboot the system.

2.4 Upgrade the Firmware and Reboot the Singlewire-enabled Speaker

To upload the Singlewire-enabled Speaker firmware from your PC:

1. Set up a TFTP server.

If you do not already have a TFTP server running on your network, see [Appendix B, "Setting up a TFTP Server"](#).

2. Retrieve the latest Singlewire-enabled Speaker firmware from the Singlewire-enabled Speaker **Downloads** page at:
<http://www.cyberdata.net/products/voip/digitalanalog/singlewirespeaker/downloads.html>
3. Unzip the Singlewire-enabled Speaker version file. This file may contain the following:
 - Firmware file
 - Release notes
4. Copy the firmware files to be upgraded to the appropriate TFTP server directory:
 - c:\tftp-root\for Windows
 - /tftpboot/for Linux
5. Log in to the Singlewire-enabled Speaker home page as instructed in [Section 2.3.1, "Log in to the Configuration Home Page"](#).

- Click the **Update Firmware** button to open the **Upgrade Firmware** page. See [Figure 2-14](#).

Figure 2-14. Firmware Upgrade Page

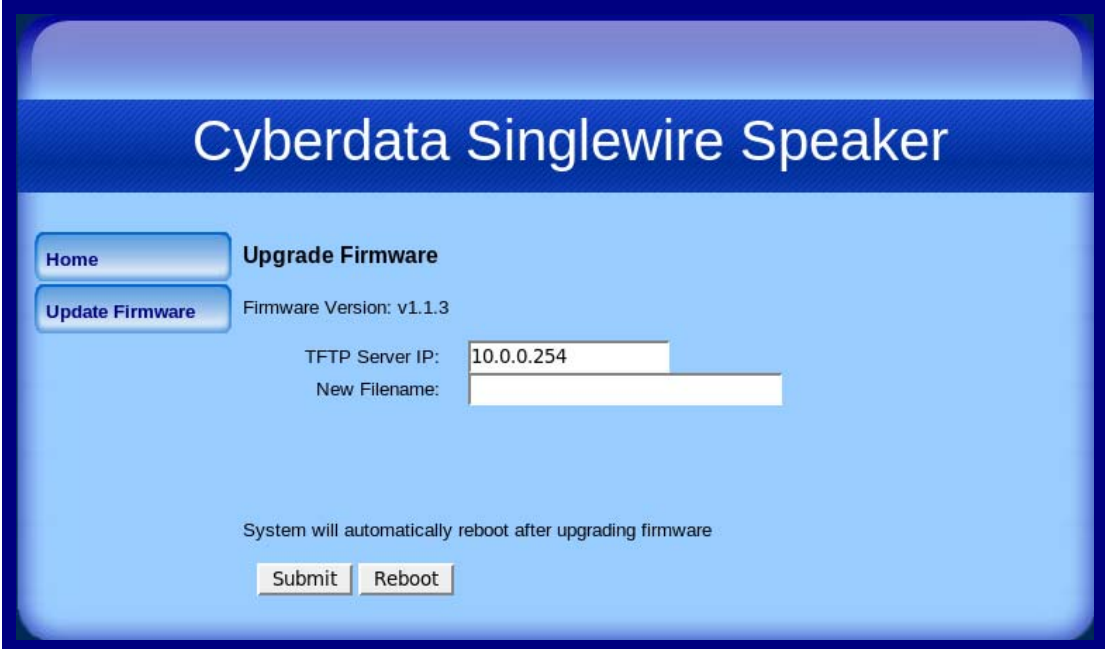

Cyberdata Singlewire Speaker

Home Upgrade Firmware

Update Firmware Firmware Version: v1.1.3

TFTP Server IP: 10.0.0.254

New Filename:

System will automatically reboot after upgrading firmware

Submit Reboot





Note [Figure 2-14](#) shows the factory default settings.

- Enter the IP address of your TFTP server into the **TFTP Server IP** parameter field.
- Enter the firmware filename of the file to be uploaded into the **New Filename** parameter field.
For example, kernel filename **201-image-spk-sip.bin**.
- Click **Upload File**.

Note This starts the upload process. Once the Singlewire-enabled Speaker has uploaded the file, the **Uploading Firmware** countdown page appears, indicating that the firmware is being written to flash. The Singlewire-enabled Speaker will automatically reboot when the upload is complete. When the countdown finishes, the **Upgrade Firmware** page will refresh. The uploaded firmware filename should be displayed in the system configuration (indicating successful upload and reboot).

Table 2-5 shows the web page items on the **Upgrade Firmware** page.

Table 2-5. Firmware Upgrade Parameters

Web Page Item	Description
Firmware Version	Shows the current firmware version.
TFTP Server IP address	Enter the IP address of your TFTP server into the TFTP Server IP parameter field (15 character limit).
New Filename	Use this field to enter the new file name for the kernel or application firmware file that you are uploading (25 character limit).
	Link to the Home page.
	Link to the Update Firmware page.
	Click on the Submit button to automatically upload the selected firmware and reboot the system.
	Click on the Reboot button to reboot the system.

2.4.1 Reboot the Singlewire-enabled Speaker

To reboot a Singlewire-enabled Speaker, log in to the web page as instructed in [Section 2.3.1, "Log in to the Configuration Home Page"](#).

1. Click **Update Firmware** to open the **Upgrade Firmware** page ([Figure 2-15](#)).

Figure 2-15. Reboot System Section

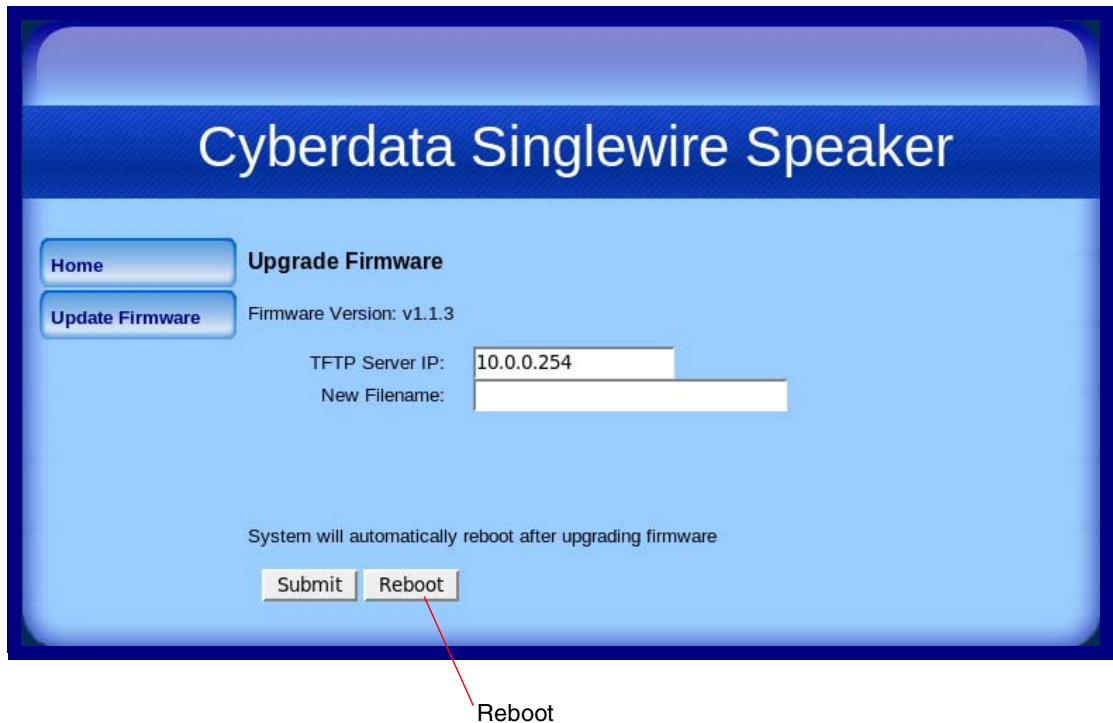

2. Click **Reboot**. A normal restart will occur and you will see the following Reboot page.

Figure 2-16. Reboot Page



2.5 Identifying and Testing a Ceiling Speaker when Using InformaCast 4.0 or Later

This section describes the basic process for identifying and testing the CyberData IP Ceiling speaker when using Singlewire's InformaCast software version 4.0 or later.

Note If you have questions or need help, please consult your InformaCast documentation and or contact the CyberData support team.

Note CyberData's support is limited to IP endpoint functionality when used with an InformaCast system.

To add the Singlewire-enabled Speaker to the InformaCast server:

1. Click **Edit IP Speakers** on the **Main Screen** of the **Singlewire Informacast Server Web Interface**.

Figure 2-17. Main Screen of the Singlewire InformaCast Server Web Interface

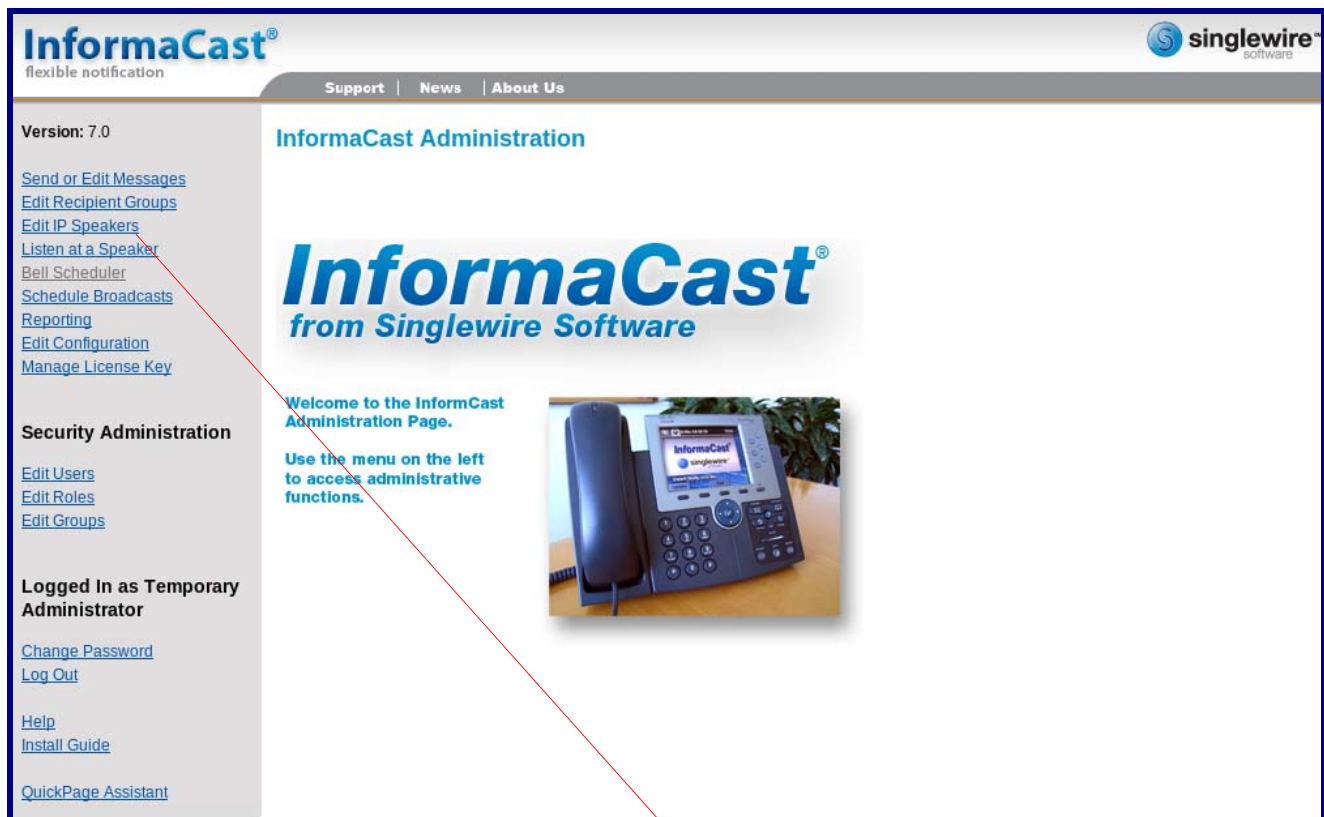

Edit IP Speakers

2. On the **IP Speaker Configuration** page, InformaCast will indicate that it has detected new speakers. Click **View**.

Figure 2-18. IP Speaker Configuration Page

InformaCast
flexible notification

singlewire
software

Support | News | About Us

Version: 7.0

[Send or Edit Messages](#)
[Edit Recipient Groups](#)
[Edit IP Speakers](#)
[Listen at a Speaker](#)
[Bell Scheduler](#)
[Schedule Broadcasts](#)
[Reporting](#)
[Edit Configuration](#)
[Manage License Key](#)

Security Administration
[Edit Users](#)
[Edit Roles](#)
[Edit Groups](#)

Logged In as Temporary Administrator
[Change Password](#)
[Log Out](#)
[Help](#)
[Install Guide](#)
[QuickPage Assistant](#)

InformaCast Administration: IP Speaker Configuration

InformaCast has detected new IP Speakers on the network. [View](#)

Filter:

There are no IP Speakers known to InformaCast.

You can reboot IP speakers using these options:

Only selected speakers will be rebooted. The number of selected speakers is shown above.

This will attempt to reboot all speakers that have registered with InformaCast, whether they are listed on this page or are "new" speakers.

You can adjust IP speaker volume using these options:

Volume Adjustment:

Only selected speakers will have their volume adjusted. The number of selected speakers is shown above.

This will attempt to adjust the volume of all configured speakers.

If you have many IP Speakers to define, they can be imported from a Comma Separated Values file, exported from a spreadsheet. Please refer to the InformaCast documentation regarding the format of the CSV file, or visit the [Help Page](#) (under "Tools") to find an Excel spreadsheet you can start

InformaCast has detected new speakers.

View

3. The **IP Speaker Configuration** page will show four newly detected speakers. Click **Test**.

Figure 2-19. IP Speaker Configuration Page

InformaCast
flexible notification

singlewire software

Support | News | About Us

Version: 7.0

[Send or Edit Messages](#)
[Edit Recipient Groups](#)
[Edit IP Speakers](#)
[Listen at a Speaker](#)
[Bell Scheduler](#)
[Schedule Broadcasts](#)
[Reporting](#)
[Edit Configuration](#)
[Manage License Key](#)

Security Administration
[Edit Users](#)
[Edit Roles](#)
[Edit Groups](#)

Logged In as Temporary Administrator
[Change Password](#)
[Log Out](#)
[Help](#)
[Install Guide](#)
[QuickPage Assistant](#)

InformaCast Administration: IP Speaker Configuration

0

MAC address	Registration Status	Action
0020f7002dc2	Registered at Thu Dec 17 12:05:55 GMT-07:00 2009 (can record), IP=10.10.1.190	Add Test
0020f7002dc3	Registered at Thu Dec 17 12:05:52 GMT-07:00 2009 (can record), IP=10.10.0.192	Add Test
0020f7002dc4	Registered at Thu Dec 17 12:06:12 GMT-07:00 2009 (can record), IP=10.10.1.191	Add Test
0020f7002dc5	Registered at Thu Dec 17 12:05:59 GMT-07:00 2009 (can record), IP=10.10.0.193	Add Test

[View](#) configured speakers.

Test

4. On the **Test IP Speaker** page, Enter a number into the **Test duration** field.
5. Click **Test**.
6. You will hear a tone from the speaker being testing.
7. After the test, click **Cancel** to return to the **IP Configuration** page.

Figure 2-20. Test IP Speaker Page

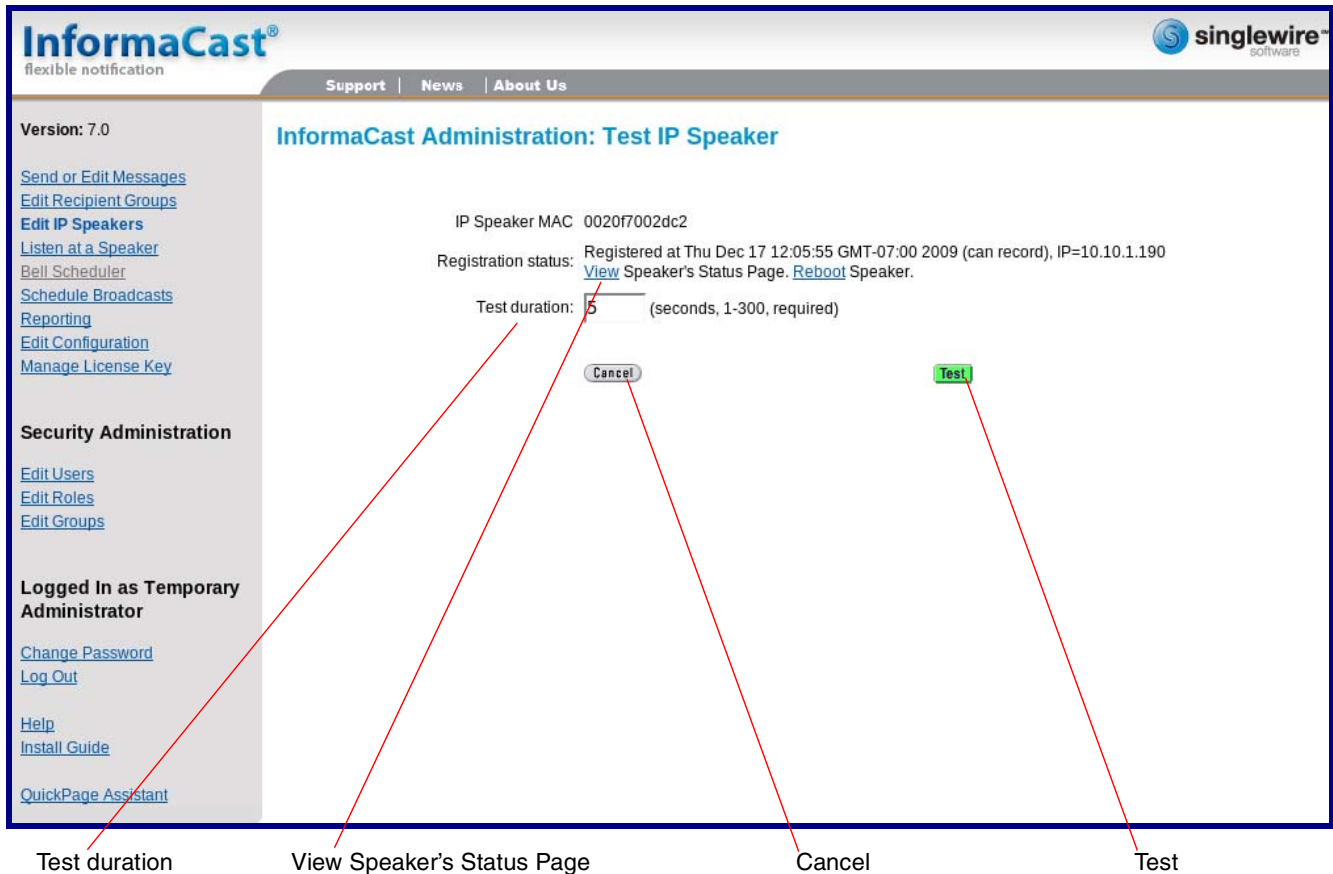

Note When viewing the speaker's status page via Informacast, Informacast links to the wrong port and path.

Informacast expects our speaker's status page to be at:

<http://<ipaddr>:10004/status>.

The status page is actually at:

[http://<ipaddr>/ \(port 80\)](http://<ipaddr>/ (port 80))

Therefore, if a user clicks the link to view the status page and is directed to:

<http://10.10.10.10:1004/status>

The user will need to edit the url in the address bar to:

<http://10.10.10.10/>

8. On the **IP Speaker Configuration** page, Click **Add** to add a speaker to the InformaCast server.

Figure 2-21. IP Configuration Page

The screenshot displays the InformaCast Administration interface for IP Speaker Configuration. The page title is "InformaCast Administration: IP Speaker Configuration". On the left sidebar, there are navigation links for "Send or Edit Messages", "Edit Recipient Groups", "Edit IP Speakers", "Listen at a Speaker", "Bell Scheduler", "Schedule Broadcasts", "Reporting", "Edit Configuration", and "Manage License Key". Below these are sections for "Security Administration" (Edit Users, Edit Roles, Edit Groups) and "Logged In as Temporary Administrator" (Change Password, Log Out, Help, Install Guide, QuickPage Assistant). The main content area shows a table of registered speakers. The table has three columns: "MAC address", "Registration Status", and "Action". There are four rows of data, each with an "Add" and "Test" button in the Action column. Below the table, there is a "View" button followed by the text "configured speakers." A red arrow originates from the "Add" button in the table and points to the "Add" button at the bottom of the page.

MAC address	Registration Status	Action
0020f7002dc2	Registered at Thu Dec 17 12:05:55 GMT-07:00 2009 (can record), IP=10.10.1.190	Add Test
0020f7002dc3	Registered at Thu Dec 17 12:05:52 GMT-07:00 2009 (can record), IP=10.10.0.192	Add Test
0020f7002dc4	Registered at Thu Dec 17 12:06:12 GMT-07:00 2009 (can record), IP=10.10.1.191	Add Test
0020f7002dc5	Registered at Thu Dec 17 12:05:59 GMT-07:00 2009 (can record), IP=10.10.0.193	Add Test

[View](#) configured speakers.

[Add](#)

9. On the **Add IP Speaker** page, Fill out appropriate fields and click **Add**.

Figure 2-22. Add IP Speaker Page

The screenshot displays the InformaCast Administration interface for adding a new IP speaker. The page title is "InformaCast Administration: Add IP Speaker". The left sidebar contains navigation links such as "Send or Edit Messages", "Edit Recipient Groups", "Edit IP Speakers", "Listen at a Speaker", "Bell Scheduler", "Schedule Broadcasts", "Reporting", "Edit Configuration", "Manage License Key", "Security Administration", "Logged In as Temporary Administrator", "Change Password", "Log Out", "Help", "Install Guide", and "QuickPage Assistant". The main content area contains the following form fields:

- IP Speaker Name: (required)
- Speaker Description:
- Dial Code: (numeric shortcut for optional phone interface)
- MAC Address: (required, 12 hex digits)
- Volume:

At the bottom of the form are two buttons: "Cancel" and "Add". A red arrow points from the "Add" button to the word "Add" located below the screenshot.

Your speaker is now registered to the InformaCast server. You now can configure this device as part of the InformaCast system setup as required.

Appendix A: Mounting the Speaker

A.1 Mount the Speaker

Before you mount the speaker, make sure that you have received all the parts for each speaker. Refer to [Table A-1](#) and [Table A-2](#).

Table A-1. Drop Ceiling Mounting Components (Part of the Accessory Kit)





Quantity	Part Name	Illustration
3	#8 Nylon Thumb Nuts	
3	#8 Fender Washers	
3	8-32 x 1 1/4" Mounting Screws	

Table A-2. Drywall Mounting Components (Part of the Accessory Kit)

Quantity	Part Name	Illustration
3	Plastic Ribbed Anchors	
3	#8 Sheet Metal Screws	

To mount the speaker:

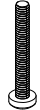
1. Use the **TEMPLATE** to cut the speaker hole and prepare holes for the screws (**Figure A-1**). This template is located on the back page of the *Installation Quick Reference Guide* that is delivered with each speaker.

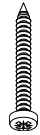
Figure A-1. VoIP Speaker Assembly

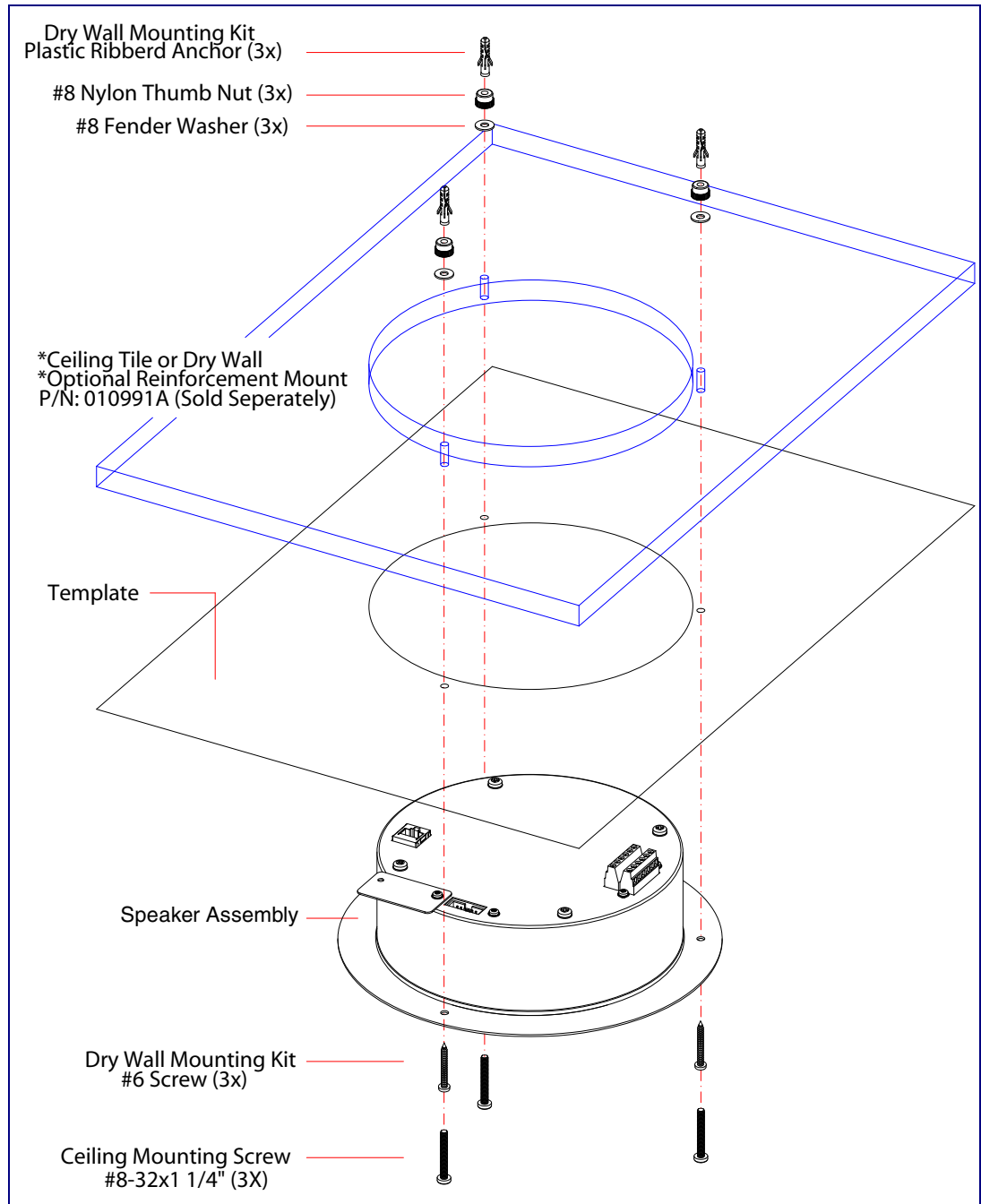

-
2. Plug the Ethernet cable into the Speaker Assembly. [Section 2.2.3, "Confirm that the Speaker is Operational and Linked to the Network"](#) explains how the **Link** and **Status** LEDs work.
 3. At this point:
 - For *drop ceiling mounting*, position the **VoIP SPEAKER ASSEMBLY** in the ceiling so that its screw holes align with those you prepared.
 - For *drywall mounting*, place the three **PLASTIC RIBBED ANCHORS** in the holes you prepared, and position the **VoIP SPEAKER ASSEMBLY** over them, aligning the screw holes in the assembly with the anchors.
 4. To fasten the speaker:
 - For *drop ceiling mounting*, use the three **8-32 x 1 1/4" MOUNTING SCREWS, #8 NYLON THUMB NUTS**, and **#8 FENDER WASHERS** to secure the speaker.

Note For weak ceiling tile, CyberData offers a reinforcing mount (CyberData part number 010991A).

- For *drywall mounting*, use the three **#8 SHEET METAL SCREWS** to secure the speaker.

Appendix B: Setting up a TFTP Server

B.1 Set up a TFTP Server

Upgrading the firmware requires a TFTP server on which you access the Web interface where you can upload the firmware files.

B.1.1 In a LINUX Environment

To set up a TFTP server on LINUX:

1. Create a directory dedicated to the TFTP server, and move the files to be uploaded to that directory.
2. Run the following command where `/tftpboot/` is the path to the directory you created in [Step 1](#): the directory that contains the files to be uploaded. For example:

```
in.tftpd -l -s /tftpboot/your_directory_name
```

B.1.2 In a Windows Environment

You can find several options online for setting up a Windows TFTP server. This example explains how to use the Solarwinds freeware TFTP server, which you can download at:

<http://www.cyberdata.net/support/voip/solarwinds.html>

To set up a TFTP server on Windows:

1. Install and start the software.
2. Select **File/Configure/Security** tab/**Transmit Only**.
3. Make a note of the default directory name, and then move the firmware files to be uploaded to that directory.

Appendix C: Troubleshooting/Technical Support

C.1 Frequently Asked Questions (FAQ)

To see a list of frequently asked questions, go to the following URL:

<http://www.cyberdata.net/products/voip/digitalanalog/singlewirespeaker/faqs.html>

C.2 Documentation

The documentation for this product is released in an English language version only. You can download PDF copies of CyberData product documentation by going to the following URL:

<http://www.cyberdata.net/products/voip/digitalanalog/singlewirespeaker/docs.html>

C.3 Contact Information

Contact	<p>CyberData Corporation 2555 Garden Road Monterey, CA 93940 USA www.CyberData.net Phone: 800-CYBERDATA (800-292-3732) Fax: 831-373-4193</p>
Sales	Sales 831-373-2601 Extension 334
Technical Support	<p>Phone: 831-373-2601 Extension 333 Web: http://www.cyberdata.net/support/contactsupportvoip.html</p>
Returned Materials Authorization	<p>To return the product, contact the CyberData Returned Materials Authorization (RMA) department at:</p> <p>Phone: 831-373-2601, Extension 136 Email: RMA@CyberData.net</p> <p>When returning a product to CyberData, an approved CyberData RMA number must be printed on the outside of the original shipping package. No product will be accepted for return without an approved RMA number. Send the product, in its original package, to the following address:</p> <p>CyberData Corporation 2555 Garden Road Monterey, CA 93940 Attention: RMA "your RMA number"</p>
RMA Status Form	<p>If you need to inquire about the repair status of your product(s), please use the CyberData RMA Status form at the following web address:</p> <p>http://www.cyberdata.net/support/rmastatus.html</p>

C.4 Warranty

CyberData warrants its product against defects in material or workmanship for a period of two years from the date of purchase. Should the product fail within the warranty period, CyberData will repair or replace the product free of charge. This warranty includes all parts and labor.

Should the product fail out-of-warranty, a flat rate repair charge of one half of the purchase price of the product will be assessed. Repairs that are in warranty but are damaged by improper modifications or abuse, will be charged at the out-of-warranty rate. Products shipped to CyberData, both in and out-of-warranty, are shipped at the expense of the customer. Shipping charges for repaired products shipped back to the customer by CyberData, will be paid by CyberData.

CyberData shall not under any circumstances be liable to any person for any special, incidental, indirect or consequential damages, including without limitation, damages resulting from use or malfunction of the products, loss of profits or revenues or costs of replacement goods, even if CyberData is informed in advance of the possibility of such damages.

C.4.1 Warranty & RMA Returns within the United States

If service is required, you must contact CyberData Technical Support prior to returning any products to CyberData. Our Technical Support staff will determine if your product should be returned to us for further inspection. If Technical Support determines that your product needs to be returned to CyberData, an RMA number will be issued to you at this point.

Your issued RMA number must be printed on the outside of the shipping box. No product will be accepted for return without an approved RMA number. The product in its original package should be sent to the following address:

CyberData Corporation

2555 Garden Rd.

Monterey, CA 93940

Attn: RMA "xxxxxx"

C.4.2 Warranty & RMA Returns Outside of the United States

If you purchased your equipment through an authorized international distributor or reseller, please contact them directly for product repairs.

C.4.3 Spare in the Air Policy

CyberData now offers a *Spare in the Air* no wait policy for warranty returns within the United States and Canada. More information about the *Spare in the Air* policy is available at the following web address:

<http://www.cyberdata.net/support/warranty/spareintheair.html>

C.4.4 Return and Restocking Policy

For our authorized distributors and resellers, please refer to your CyberData Service Agreement for information on our return guidelines and procedures.

For End Users, please contact the company that you purchased your equipment from for their return policy.

C.4.5 Warranty and RMA Returns Page

The most recent warranty and RMA information is available at the CyberData Warranty and RMA Returns Page at the following web address:

<http://www.cyberdata.net/support/warranty/index.html>

Index

Symbols

#8 fender washers 29, 31
 #8 nylon thumb nuts 29, 31
 #8 sheet metal screws 29, 31

Numerics

8-32 x 1 1/4" mounting screws 29, 31

A

address, configuration login 17
 adjusting volume 13
 ambient operating temperature 4
 announcing a speaker's IP address 13, 15
 audio test 13

C

configurable parameters 18
 configuration
 device 7
 using Web interface 16
 configuration home page 17
 confirming IP address 13
 contact information 34
 contact information for CyberData 34
 CyberData contact information 34
 CyberData Singlewire-enabled Speaker
 overview 1
 CyberData support limited to IP endpoint
 functionality 23

D

default
 gateway 7, 16
 IP address 7, 16
 subnet mask 7, 16
 username and password 7, 16
 web login username and password 17
 default gateway 7, 16
 default login address 17

device configuration 7
 dimensions 4, 5
 drivers 33
 drop ceiling mounting of speaker 31
 drywall mounting of speaker 31

E

Ethernet cable 31

F

factory default settings
 how to set 15
 faqs 33
 features 3
 firmware
 where to get the latest firmware 19
 firmware upgrade parameters 21
 firmware upgrades 32
 frequently asked questions (faqs) 33

H

home page 17

I

identifying the speaker (when using InformaCast 4.0) 23
 identifying your product 2
 illustration of speaker mounting process 29
 InformaCast
 Add IP Speaker Page 28
 IP Speaker Configuration page 24
 Test IP Speaker Page 26
 testing and identifying a Singlewire-enabled ceiling
 speaker 23
 Informacast linking to the wrong port and path 26
 InformaCast needs to be 4.0 or higher 1
 installation, typical speaker system 3
 IP address 7, 16, 21
 IP addressing
 default
 IP addressing setting 7, 16

L

link LED 31
Linux, setting up a TFTP server on 32
log in address 17

M

mounting a speaker 29

N

network link activity, verifying 12

O

output 4
overview 1

P

parts
 #8 fender washers 29
 #8 nylon thumb nuts 29
 #8 sheet metal screws 29
 8-32 x 1 1/4" mounting screws 29
 plastic ribbed anchors 29
password
 login 17
 restoring the default 7, 16
pdf copies 33
plastic ribbed anchors 29, 31
port baud rate 4
power requirement 4
power, connecting to speaker 7
product
 configuring 16
 mounting 29
 parts list 6
product features 3
product overview 1
 product features 3
 product specifications 4
product specifications 4

R

reboot 21
rebooting the Singlewire-enabled speaker 22
Reset Test Function Management (RTFM) switch 13, 15
restoring the factory default settings 15
return and restocking policy 35
RMA returned materials authorization 34
RMA status 34
RTFM switch 13, 15

S

sales 34
Second Speaker Setup 10
sensitivity 4
service 34
setting up a TFTP server 32
Singlewire Informacast Server Web Interface 23
Singlewire-enabled Ceiling Speaker
 how to identify 2
Singlewire-enabled Speaker
 installation 3
Singlewire-enabled Speaker (with PoE Injector) to a
 802.3af Compliant PoE Switch 8
Singlewire-enabled Speaker to a 802.3af Compliant PoE
 Switch 7
Singlewire-enabled Speaker with Extra Speaker
 Connection 10
Singlewire-enabled Speaker with Line Out 11
Spare in the Air Policy 35
speaker configuration page
 configurable parameters 18
status LED 31
subnet mask 7, 16

T

tech support 34
technical support 33
technical support, contact information 34
template for speaker and screw holes 30
testing audio 13
testing the speaker (when using InformaCast 4.0) 23
TFTP server 32
typical system installation 3

U

username

- default for web configuration access 17
- restoring the default 7, 16
- utilities 33

V

- verifying
 - network link and activity 12
 - power on to speaker 12
- VoIP speaker assembly 31
- volume, adjusting 13

W

- warranty 34
- warranty & RMA returns outside of the United States 35
- warranty & RMA returns within the United States 35
- warranty and RMA returns page 35
- warranty policy at CyberData 34
- web access password 7, 16
- web access username 7, 16
- web configuration log in address 17
- web-based speaker configuration 16
- weight 4
- Windows, setting up a TFTP server on 32

Free Manuals Download Website

<http://myh66.com>

<http://usermanuals.us>

<http://www.somanuals.com>

<http://www.4manuals.cc>

<http://www.manual-lib.com>

<http://www.404manual.com>

<http://www.luxmanual.com>

<http://aubethermostatmanual.com>

Golf course search by state

<http://golfingnear.com>

Email search by domain

<http://emailbydomain.com>

Auto manuals search

<http://auto.somanuals.com>

TV manuals search

<http://tv.somanuals.com>