

8-Mbit (1024K x 8) Static RAM

Features

- Very high speed: 45 ns
 - Wide voltage range: 2.20V–3.60V
- Pin compatible with CY62158DV30
- Ultra low standby power
 - Typical standby current: 2 μ A
 - Maximum standby current: 8 μ A
- Ultra low active power
 - Typical active current: 1.8 mA @ f = 1 MHz
- Easy memory expansion with \overline{CE}_1 , CE_2 , and \overline{OE} features
- Automatic power down when deselected
- CMOS for optimum speed/power
- Offered in Pb-free 48-ball VFBGA, 44-pin TSOP II and 48-pin TSOP I packages^[1]

Functional Description ^[2]

The CY62158EV30 is a high performance CMOS static RAM organized as 1024K words by 8 bits. This device features advanced circuit design to provide ultra low active current. This is ideal for providing More Battery Life™ (MoBL[®]) in portable applications such as cellular telephones. The device also has an automatic power down feature that significantly reduces power consumption. Placing the device into standby mode reduces power consumption significantly when deselected (\overline{CE}_1 HIGH or CE_2 LOW). The eight input and output pins (IO₀ through IO₇) are placed in a high impedance state when the device is deselected (\overline{CE}_1 HIGH or CE_2 LOW), the outputs are disabled (\overline{OE} HIGH), or a write operation is in progress (CE_1 LOW and CE_2 HIGH and \overline{WE} LOW).

To write to the device, take Chip Enables (\overline{CE}_1 LOW and CE_2 HIGH) and Write Enable (\overline{WE}) input LOW. Data on the eight IO pins (IO₀ through IO₇) is then written into the location specified on the address pins (A₀ through A₁₉).

To read from the device, take Chip Enables (\overline{CE}_1 LOW and CE_2 HIGH) and \overline{OE} LOW while forcing the \overline{WE} HIGH. Under these conditions, the contents of the memory location specified by the address pins appear on the IO pins. See the "Truth Table" on page 8 for a complete description of read and write modes.

Logic Block Diagram

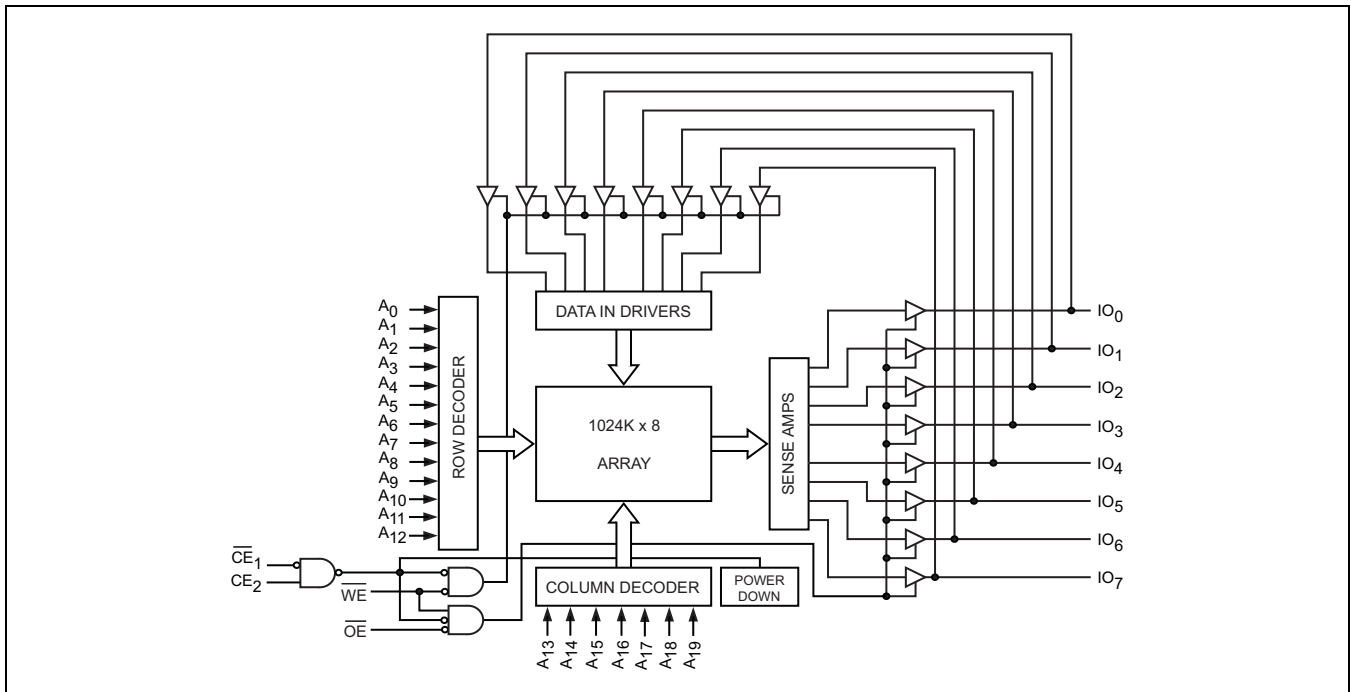

Notes

1. For 48 pin TSOP I pin configuration and ordering information, please refer to CY62157EV30 Data sheet.
2. For best practice recommendations, refer to the Cypress application note "System Design Guidelines" at <http://www.cypress.com>.

Pin Configurations ^[3]

48-Ball VFBGA

Top View

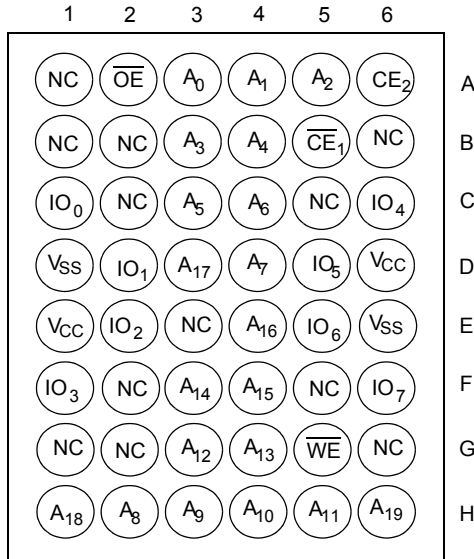

44-Pin TSOPII

Top View

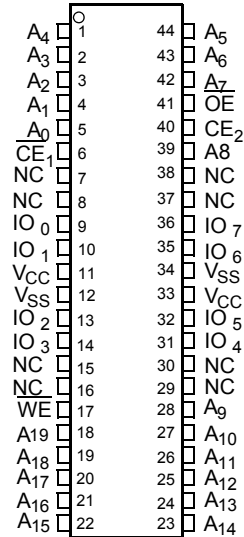

Product Portfolio

Product	V _{CC} Range (V)			Speed (ns)	Power Dissipation					
					Operating I _{CC} (mA)				Standby, I _{SB2} (μA)	
	f = 1 MHz		f = f _{max}							
	Min	Typ ^[4]	Max		Typ ^[4]	Max	Typ ^[4]	Max	Typ ^[4]	Max
CY62158EV30LL	2.2	3.0	3.6	45	1.8	3	18	25	2	8

Notes

3. NC pins are not connected on the die.

4. Typical values are included for reference only and are not guaranteed or tested. Typical values are measured at V_{CC} = V_{CC(typ)}, T_A = 25°C.

Maximum Ratings

Exceeding the maximum ratings may impair the useful life of the device. These user guidelines are not tested.

Storage Temperature -65°C to +150°C
 Ambient Temperature with Power Applied -55°C to +125°C
 Supply Voltage to Ground Potential -0.3V to $V_{CC(max)}$ + 0.3V
 DC Voltage Applied to Outputs in High-Z State^[5, 6] -0.3V to $V_{CC(max)}$ + 0.3V
 DC Input Voltage^[5, 6] -0.3V to $V_{CC(max)}$ + 0.3V

Output Current into Outputs (LOW)..... 20 mA
 Static Discharge Voltage..... >2001V (MIL-STD-883, Method 3015)
 Latch up Current..... >200 mA

Operating Range

Product	Range	Ambient Temperature (T _A)	V _{CC} ^[7]
CY62158EV30LL	Industrial	-40°C to +85°C	2.2V – 3.6V

Electrical Characteristics (Over the Operating Range)

Parameter	Description	Test Conditions	45 ns			Unit
			Min	Typ ^[4]	Max	
V _{OH}	Output HIGH Voltage	I _{OH} = -0.1 mA	2.0			V
		I _{OH} = -1.0 mA, V _{CC} ≥ 2.70V	2.4			V
V _{OL}	Output LOW Voltage	I _{OL} = 0.1 mA			0.4	V
		I _{OL} = 2.1 mA, V _{CC} ≥ 2.70V			0.4	V
V _{IH}	Input HIGH Voltage	V _{CC} = 2.2V to 2.7V	1.8		V _{CC} + 0.3V	V
		V _{CC} = 2.7V to 3.6V	2.2		V _{CC} + 0.3V	V
V _{IIL}	Input LOW Voltage	V _{CC} = 2.2V to 2.7V	-0.3		0.6	V
		V _{CC} = 2.7V to 3.6V	-0.3		0.8	V
I _{IX}	Input Leakage Current	GND ≤ V _I ≤ V _{CC}	-1		+1	μA
I _{OZ}	Output Leakage Current	GND ≤ V _O ≤ V _{CC} , Output Disabled	-1		+1	μA
I _{CC}	V _{CC} Operating Supply Current	f = f _{max} = 1/t _{RC} V _{CC} = V _{CCmax} I _{OUT} = 0 mA CMOS levels		18	25	mA
		f = 1 MHz		1.8	3	mA
I _{SB1}	Automatic CE Power down Current — CMOS Inputs	CE ₁ ≥ V _{CC} - 0.2V, CE ₂ ≤ 0.2V V _{IN} ≥ V _{CC} - 0.2V, V _{IN} ≤ 0.2V f = f _{max} (Address and Data Only), f = 0 (OE and WE), V _{CC} = 3.60V		2	8	μA
I _{SB2} ^[8]	Automatic CE Power down Current — CMOS Inputs	CE ₁ ≥ V _{CC} - 0.2V or CE ₂ ≤ 0.2V, V _{IN} ≥ V _{CC} - 0.2V or V _{IN} ≤ 0.2V, f = 0, V _{CC} = 3.60V		2	8	μA

Capacitance^[9]

Parameter	Description	Test Conditions	Max	Unit
C _{IN}	Input Capacitance	T _A = 25°C, f = 1 MHz, V _{CC} = V _{CC(typ)}	10	pF
C _{OUT}	Output Capacitance		10	pF

Notes

- V_{IL(min)} = -2.0V for pulse durations less than 20 ns.
- V_{IH(max)} = V_{CC} + 0.75V for pulse duration less than 20 ns.
- Full device AC operation assumes a 100 μs ramp time from 0 to V_{CC(min)} and 200 μs wait time after V_{CC} stabilization.
- Only chip enables (CE₁ and CE₂) must be at CMOS level to meet the I_{SB2} / I_{CCDR} spec. Other inputs can be left floating.
- Tested initially and after any design or process changes that may affect these parameters.

Thermal Resistance^[9]

Parameter	Description	Test Conditions	BGA	TSOP II	Unit
Θ_{JA}	Thermal Resistance (Junction to Ambient)	Still Air, soldered on a 3 x 4.5 inch, two-layer printed circuit board	72	76.88	°C/W
Θ_{JC}	Thermal Resistance (Junction to Case)		8.86	13.52	°C/W

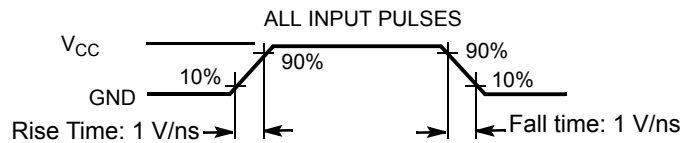
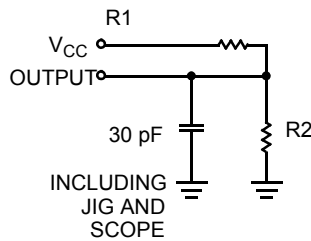
AC Test Loads and Waveforms

Equivalent to: THÉVENIN EQUIVALENT

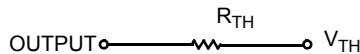

Parameters	2.5V	3.0V	Unit
R1	16667	1103	Ω
R2	15385	1554	Ω
R_{TH}	8000	645	Ω
V_{TH}	1.20	1.75	V

Data Retention Characteristics (Over the Operating Range)

Parameter	Description	Conditions	Min	Typ ^[4]	Max	Unit
V_{DR}	V_{CC} for Data Retention		1.5			V
I_{CCDR} ^[8]	Data Retention Current	$V_{CC} = 1.5V, \overline{CE}_1 \geq V_{CC} - 0.2V$ or $CE_2 \leq 0.2V, V_{IN} \geq V_{CC} - 0.2V$ or $V_{IN} \leq 0.2V$		2	5	μA
t_{CDR} ^[9]	Chip Deselect to Data Retention Time		0			ns
t_R ^[10]	Operation Recovery Time		t_{RC}			ns

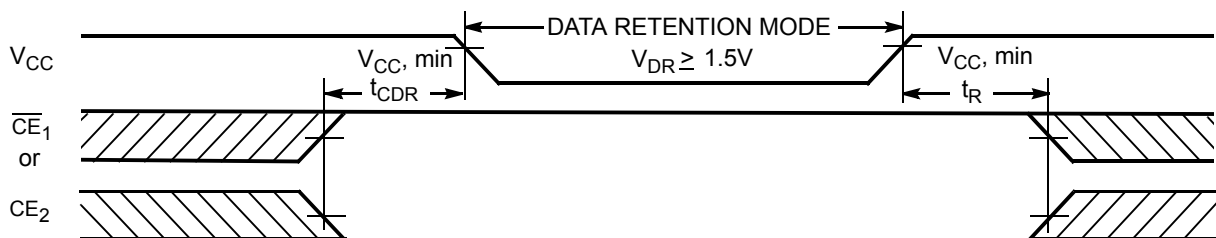
Data Retention Waveform

Note

 10. Full Device AC operation requires linear V_{CC} ramp from V_{DR} to $V_{CC(min)} \geq 100 \mu s$ or stable at $V_{CC(min)} \geq 100 \mu s$.

Switching Characteristics (Over the Operating Range) ^[11]

Parameter	Description	45 ns		Unit
		Min	Max	
Read Cycle				
t_{RC}	Read Cycle Time	45		ns
t_{AA}	Address to Data Valid		45	ns
t_{OHA}	Data Hold from Address Change	10		ns
t_{ACE}	\overline{CE}_1 LOW and CE_2 HIGH to Data Valid		45	ns
t_{DOE}	\overline{OE} LOW to Data Valid		22	ns
t_{LZOE}	\overline{OE} LOW to Low Z ^[12]	5		ns
t_{HZOE}	\overline{OE} HIGH to High Z ^[12, 13]		18	ns
t_{LZCE}	\overline{CE}_1 LOW and CE_2 HIGH to Low Z ^[12]	10		ns
t_{HZCE}	\overline{CE}_1 HIGH or CE_2 LOW to High Z ^[12, 13]		18	ns
t_{PU}	\overline{CE}_1 LOW and CE_2 HIGH to Power Up	0		ns
t_{PD}	\overline{CE}_1 HIGH or CE_2 LOW to Power Down		45	ns
Write Cycle^[14]				
t_{WC}	Write Cycle Time	45		ns
t_{SCE}	\overline{CE}_1 LOW and CE_2 HIGH to Write End	35		ns
t_{AW}	Address Setup to Write End	35		ns
t_{HA}	Address Hold from Write End	0		ns
t_{SA}	Address Setup to Write Start	0		ns
t_{PWE}	\overline{WE} Pulse Width	35		ns
t_{SD}	Data Setup to Write End	25		ns
t_{HD}	Data Hold from Write End	0		ns
t_{HZWE}	\overline{WE} LOW to High Z ^[12, 13]		18	ns
t_{LZWE}	\overline{WE} HIGH to Low Z ^[12]	10		ns

Notes

11. Test conditions for all parameters other than tri-state parameters assume signal transition time of 3 ns or less (1V/ns), timing reference levels of $V_{CC(typ)}/2$, input pulse levels of 0 to $V_{CC(typ)}$, and output loading of the specified I_{OL}/I_{OH} as shown in "AC Test Loads and Waveforms" on page 4.
12. At any given temperature and voltage condition, t_{HZCE} is less than t_{LZCE} , t_{HZOE} is less than t_{LZOE} , and t_{HZWE} is less than t_{LZWE} for any given device.
13. t_{HZOE} , t_{HZCE} , and t_{HZWE} transitions are measured when the outputs enter a high impedance state.
14. The internal write time of the memory is defined by the overlap of \overline{WE} , $CE_1 = V_{IL}$, and $CE_2 = V_{IH}$. All signals must be ACTIVE to initiate a write and any of these signals can terminate a write by going INACTIVE. The data input setup and hold timing should be referenced to the edge of the signal that terminates the write.

Switching Waveforms

Read Cycle No. 1 (Address Transition Controlled)^[15, 16]

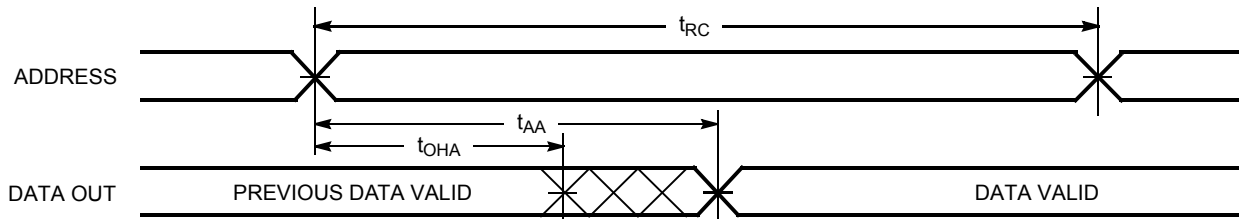

Read Cycle No. 2 (\overline{OE} Controlled)^[16, 17]

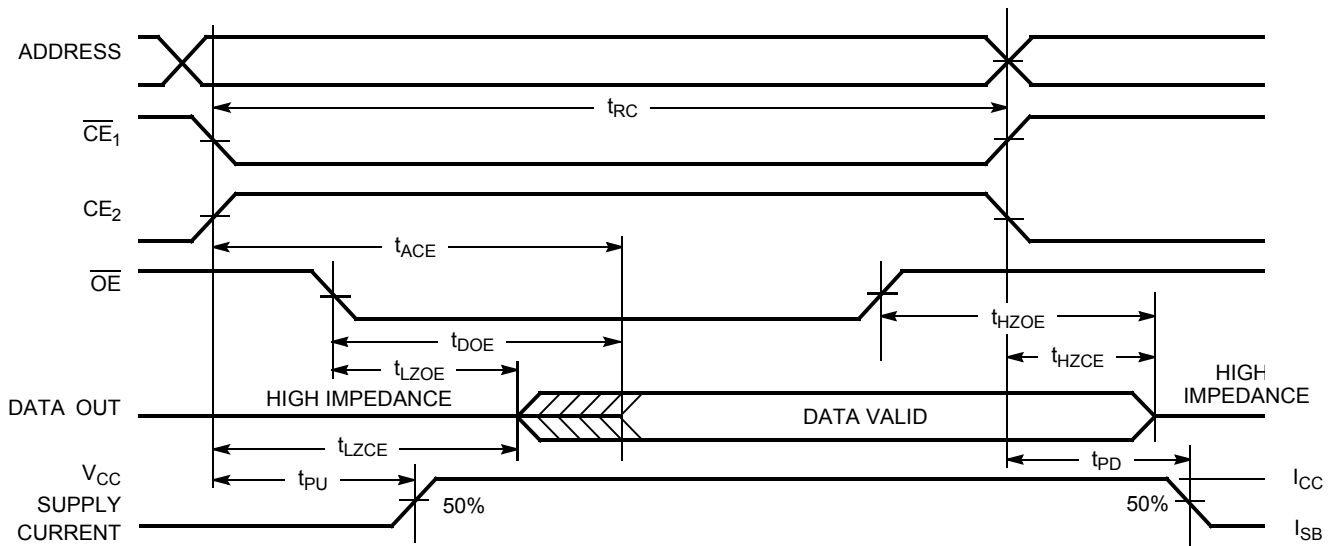

Notes

- 15. Device is continuously selected. \overline{OE} , $\overline{CE}_1 = V_{IL}$, $CE_2 = V_{IH}$.
- 16. \overline{WE} is HIGH for read cycle.
- 17. Address valid before or similar to \overline{CE}_1 transition LOW and CE_2 transition HIGH.

Switching Waveforms (continued)

Write Cycle No. 1 (\overline{WE} Controlled)^[14, 18, 19]

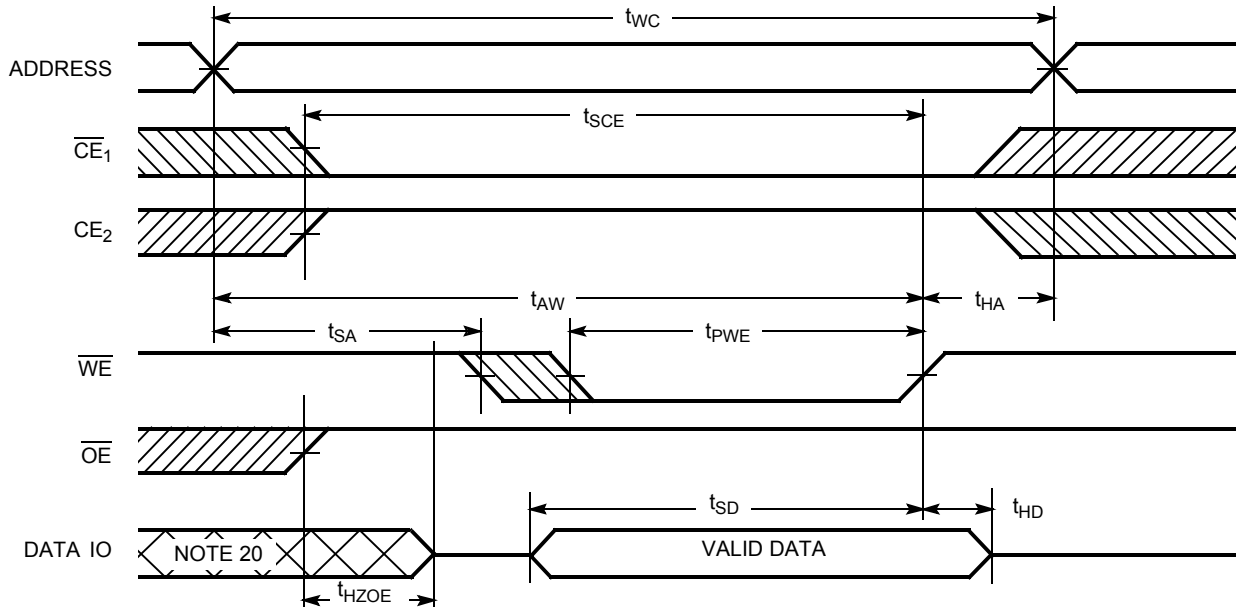

Write Cycle No. 2 (\overline{CE}_1 or CE_2 Controlled)^[14, 18, 19]

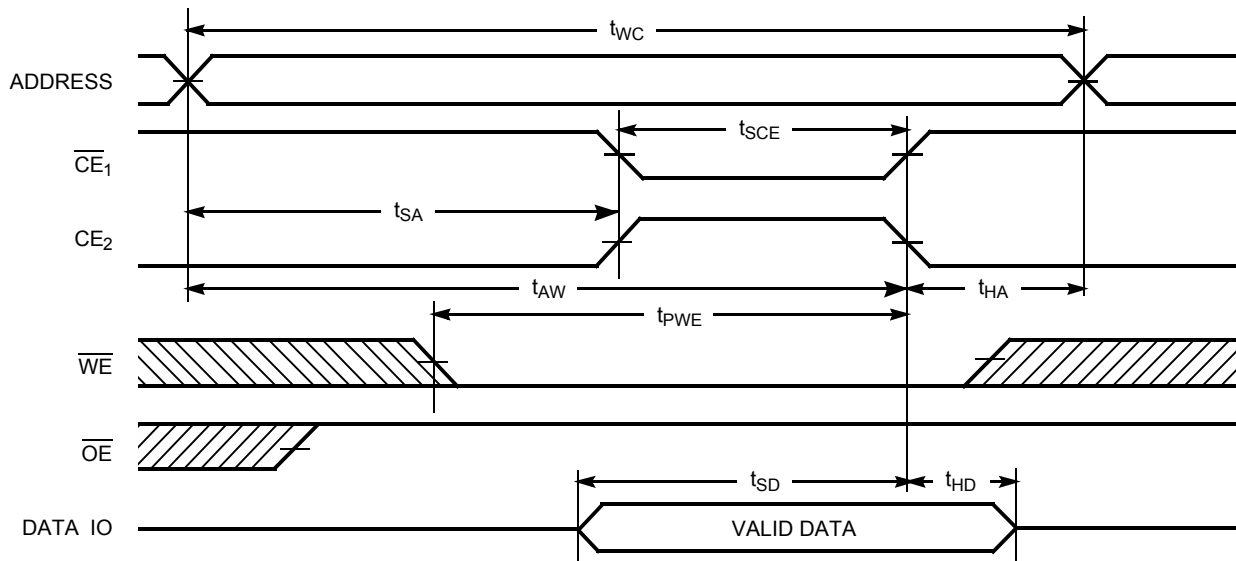

Notes

- 18. Data IO is high impedance if $\overline{OE} = V_{IH}$.
- 19. If \overline{CE}_1 goes HIGH or CE_2 goes LOW simultaneously with \overline{WE} HIGH, the output remains in high impedance state.
- 20. During this period, the IOs are in output state. Do not apply input signals.

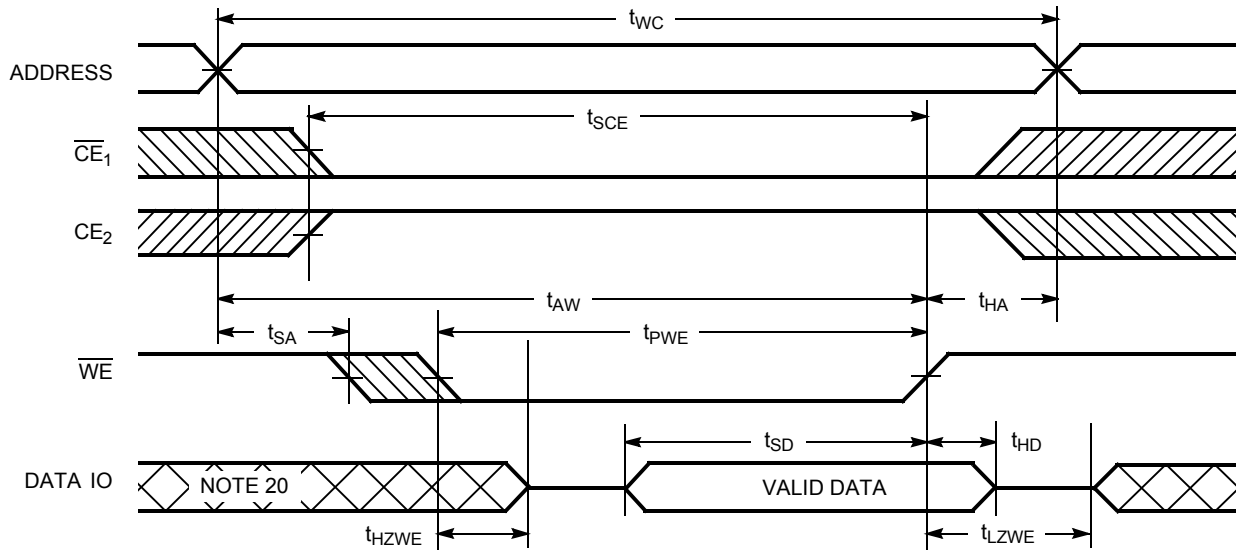
Switching Waveforms (continued)
Write Cycle No. 3 (\overline{WE} Controlled, \overline{OE} LOW)^[19]

Truth Table

\overline{CE}_1	\overline{CE}_2	\overline{WE}	\overline{OE}	Inputs/Outputs	Mode	Power
H	X	X	X	High Z	Deselect/Power Down	Standby (I_{SB})
X	L	X	X	High Z	Deselect/Power Down	Standby (I_{SB})
L	H	H	L	Data Out	Read	Active (I_{CC})
L	H	H	H	High Z	Output Disabled	Active (I_{CC})
L	H	L	X	Data in	Write	Active (I_{CC})

Ordering Information

Speed (ns)	Ordering Code	Package Diagram	Package Type	Operating Range
45	CY62158EV30LL-45BVXI	51-85150	48-ball Very Fine Pitch Ball Grid Array (Pb-free)	Industrial
	CY62158EV30LL-45ZSXI	51-85087	44-pin TSOP II (Pb-free)	

Package Diagrams

Figure 1. 48-Ball VFBGA (6 x 8 x 1 mm), 51-85150

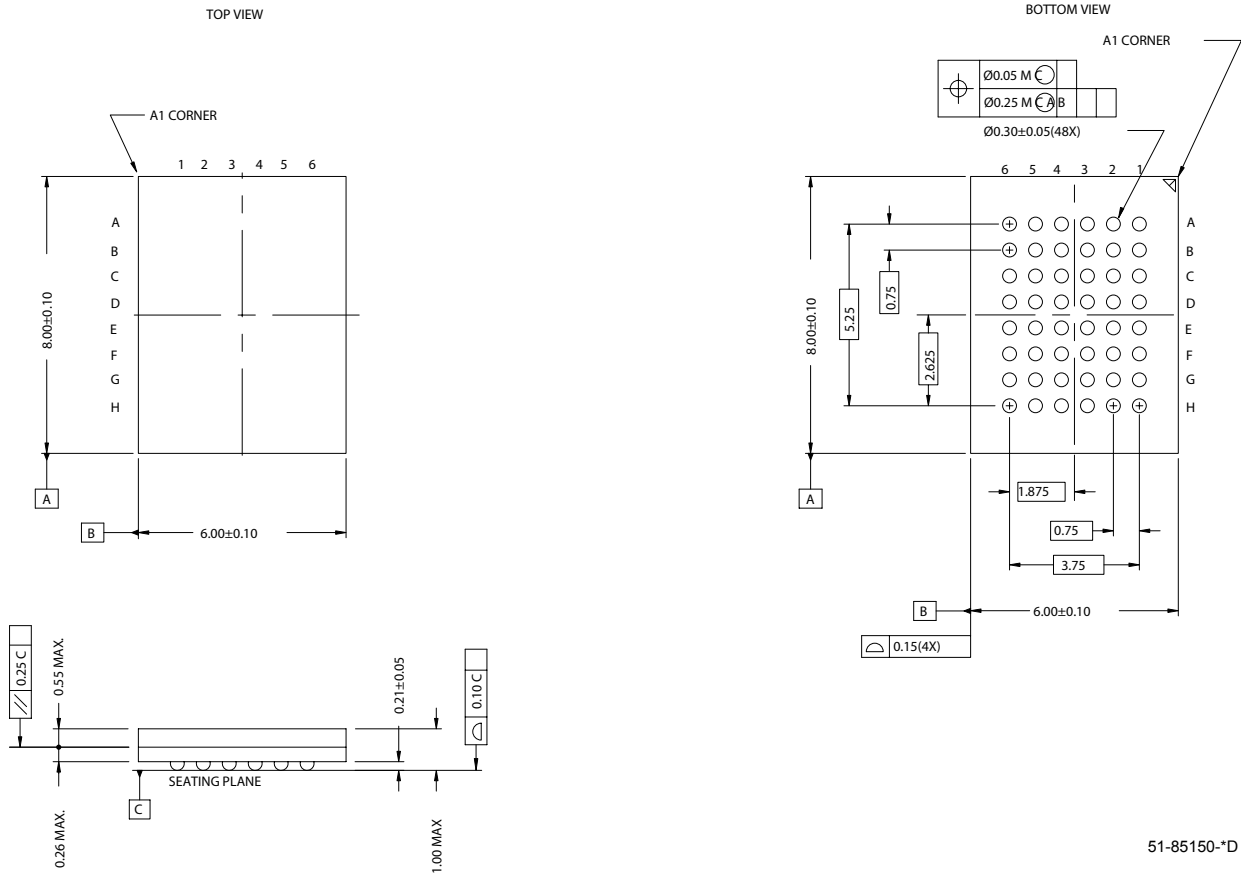

51-85150-*D

Package Diagrams (continued)

Figure 2. 44-Pin TSOP II, 51-85087

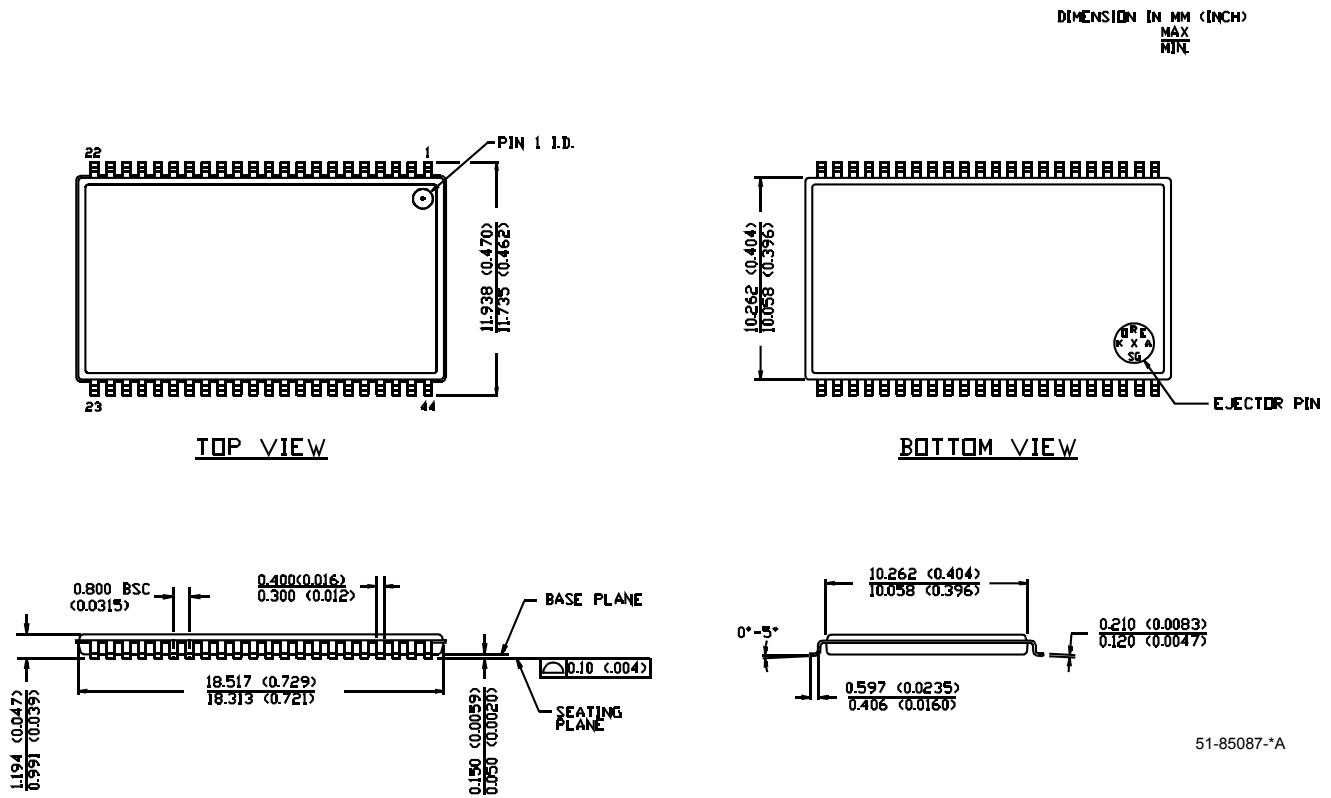

MoBL is a registered trademark, and More Battery Life is a trademark of Cypress Semiconductor. All product and company names mentioned in this document are the trademarks of their respective holders.

Document History Page

Document Title: CY62158EV30 MoBL[®], 8-Mbit (1024K x 8) Static RAM				
Document Number: 38-05578				
REV.	ECN NO.	Issue Date	Orig. of Change	Description of Change
**	270329	See ECN	PCI	New Data Sheet
*A	291271	See ECN	SYT	Converted from Advance Information to Preliminary Changed I _{CCDR} from 4 to 4.5 μA
*B	444306	See ECN	NXR	Converted from Preliminary to Final. Removed 35 ns speed bin Removed "L" bin. Removed 44 pin TSOP II package Included 48 pin TSOP I package Changed the I _{CC} Typ value from 16 mA to 18 mA and I _{CC} max value from 28 mA to 25 mA for test condition f = fax = 1/t _{RC} . Changed the I _{CC} max value from 2.3 mA to 3 mA for test condition f = 1MHz. Changed the I _{SB1} and I _{SB2} max value from 4.5 μA to 8 μA and Typ value from 0.9 μA to 2 μA respectively. Updated Thermal Resistance table Changed Test Load Capacitance from 50 pF to 30 pF. Added Typ value for I _{CCDR} . Changed the I _{CCDR} max value from 4.5 μA to 5 μA Corrected t _R in Data Retention Characteristics from 100 μs to t _{RC} ns Changed t _{LZOE} from 3 to 5 Changed t _{LZCE} from 6 to 10 Changed t _{HZCE} from 22 to 18 Changed t _{PWE} from 30 to 35 Changed t _{SD} from 22 to 25 Changed t _{LZWE} from 6 to 10 Updated the ordering Information and replaced the Package Name column with Package Diagram.
*C	467052	See ECN	NXR	Included 44 pin TSOP II package in Product Offering. Removed TSOP I package; Added reference to CY62157EV30 TSOP I Updated the ordering Information table
*D	1015643	See ECN	VKN	Added footnote #8 related to I _{SB2} and I _{CCDR}

Free Manuals Download Website

<http://myh66.com>

<http://usermanuals.us>

<http://www.somanuals.com>

<http://www.4manuals.cc>

<http://www.manual-lib.com>

<http://www.404manual.com>

<http://www.luxmanual.com>

<http://aubethermostatmanual.com>

Golf course search by state

<http://golfingnear.com>

Email search by domain

<http://emailbydomain.com>

Auto manuals search

<http://auto.somanuals.com>

TV manuals search

<http://tv.somanuals.com>