



DI-206 ISDN Router User's Guide

Rev. 04 (July 2000)

6DI206...04

Printed in Taiwan



RECYCLABLE

Copyright Statement

Copyright ©2000 D-Link Corporation

No part of this publication may be reproduced in any form or by any means or used to make any derivative such as translation, transformation, or adaptation without permission from D-Link Corporation/D-Link Systems Inc., as stipulated by the United States Copyright Act of 1976.

Trademarks

D-Link is a registered trademark of D-Link Corporation/D-Link Systems, Inc.

All other trademarks belong to their respective owners.

FCC Warning

This equipment has been tested and found to comply with the limits for a Class B digital device, pursuant to Part 15 of the FCC Rules. These limits are designed to provide reasonable protection against harmful interference in a residential installation. This equipment generates, uses, and can radiate radio frequency energy and, if not installed and used in accordance with the instructions, may cause harmful interference to radio communications. However, there is no guarantee that interference will not occur in a particular installation. If this equipment does cause harmful interference to radio or television reception, which can be determined by turning the equipment off and on, the user is encouraged to try to correct the interference by one or more of the following measures:

- Reorient or relocate the receiving antenna.
- Increase the separation between the equipment and receiver.
- Connect the equipment into an outlet on a circuit different from that to which the receiver is connected.
- Consult the dealer or an experienced radio/TV technician for help.

Shielded interface cables must be used in order to comply with emission limits.

You are cautioned that changes or modifications not expressly approved by the party responsible for compliance could void your authority to operate the equipment.

This device complies with part 15 of the FCC Rules. Operation is subject to the following two conditions: (1) This device may not cause harmful interference, and (2) this device must accept any interference received, including interference that may cause undesired operation.

CE Mark Warning

This is a Class B product. In a domestic environment, this product may cause radio interference in which case the user may be required to take adequate measures.

Limited Warranty

Hardware:

D-Link warrants each of its hardware products to be free from defects in workmanship and materials under normal use and service for a period commencing on the date of purchase from D-Link or its Authorized Reseller and extending for the length of time stipulated by the Authorized Reseller or D-Link Branch Office nearest to the place of purchase.

This Warranty applies on the condition that the product Registration Card is filled out and returned to a D-Link office within ninety (90) days of purchase. A list of D-Link offices is provided at the back of this manual, together with a copy of the Registration Card.

If the product proves defective within the applicable warranty period, D-Link will provide repair or replacement of the product. D-Link shall have the sole discretion whether to repair or replace, and replacement product may be new or reconditioned. Replacement product shall be of equivalent or better specifications, relative to the defective product, but need not be identical. Any product or part repaired by D-Link pursuant to this warranty shall have a warranty period of not less than 90 days, from date of such repair, irrespective of any earlier expiration of original warranty period. When D-Link provides replacement, then the defective product becomes the property of D-Link.

Warranty service may be obtained by contacting a D-Link office within the applicable warranty period, and requesting a Return Material Authorization (RMA) number. If a Registration Card for the product in question has not been returned to D-Link, then a proof of purchase (such as a copy of the dated purchase invoice) must be provided. If Purchaser's circumstances require special handling of warranty correction, then at the time of requesting RMA number, Purchaser may also propose special procedure as may be suitable to the case.

After an RMA number is issued, the defective product must be packaged securely in the original or other suitable shipping package to ensure that it will not be damaged in transit, and the RMA number must be prominently marked on the outside of the package. The package must be mailed or otherwise shipped to D-Link with all costs of mailing/shipping/insurance prepaid. D-Link shall never be responsible for any software, firmware, information, or memory data of Purchaser contained in, stored on, or integrated with any product returned to D-Link pursuant to this warranty.

Any package returned to D-Link without an RMA number will be rejected and shipped back to Purchaser at Purchaser's expense, and D-Link reserves the right in such a case to levy a reasonable handling charge in addition mailing or shipping costs.

Software:

Warranty service for software products may be obtained by contacting a D-Link office within the applicable warranty period. A list of D-Link offices is provided at the back of this manual, together with a copy of the Registration Card. If a Registration Card for the product in question has not been returned to a D-Link office, then a proof of purchase (such as a copy of the dated purchase invoice) must be provided when requesting warranty service. The term "purchase" in this software warranty refers to the purchase transaction and resulting license to use such software.

D-Link warrants that its software products will perform in substantial conformance with the applicable product documentation provided by D-Link with such software product, for a period of ninety (90) days from the date of purchase from D-Link or its Authorized Reseller. D-Link warrants the magnetic media, on which D-Link provides its software product, against failure during the same warranty period. This warranty applies to purchased software, and to replacement software provided by D-Link pursuant to this warranty, but shall not apply to any update or replacement which may be provided for download via the Internet, or to any update which may otherwise be provided free of charge.

D-Link's sole obligation under this software warranty shall be to replace any defective software product with product which substantially conforms to D-Link's applicable product documentation. Purchaser assumes responsibility for the selection of appropriate application and system/platform software and associated reference materials. D-Link makes no warranty that its software products will work in combination with any hardware, or any application or system/platform software product provided by any third party, excepting only such products as are expressly represented, in D-Link's applicable product documentation as being compatible. D-Link's obligation under this warranty shall be a reasonable effort to provide compatibility, but D-Link shall have no obligation to provide compatibility when there is fault in the third-party hardware or software. D-Link makes no warranty that operation of its software products will be uninterrupted or absolutely error-free, and no warranty that all defects in the software product, within or without the scope of D-Link's applicable product documentation, will be corrected.

D-Link Offices for Registration and Warranty Service

The product's Registration Card, provided at the back of this manual, must be sent to a D-Link office. To obtain an RMA number for warranty service as to a hardware product, or to obtain warranty service as to a software product, contact the D-Link office nearest you. An address/telephone/fax/e-mail/Web site list of D-Link offices is provided in the back of this manual.

Wichtige Sicherheitshinweise

1. Bitte lesen Sie sich diese Hinweise sorgfältig durch.
2. Heben Sie diese Anleitung für den spätern Gebrauch auf.
3. Vor jedem Reinigen ist das Gerät vom Stromnetz zu trennen. Verwenden Sie keine Flüssig- oder Aerosolreiniger. Am besten dient ein angefeuchtetes Tuch zur Reinigung.
4. Um eine Beschädigung des Gerätes zu vermeiden sollten Sie nur Zubehörteile verwenden, die vom Hersteller zugelassen sind.
5. Das Gerät ist vor Feuchtigkeit zu schützen.
6. Bei der Aufstellung des Gerätes ist auf sichern Stand zu achten. Ein Kippen oder Fallen könnte Verletzungen hervorrufen. Verwenden Sie nur sichere Standorte und beachten Sie die Aufstellhinweise des Herstellers.
7. Die Belüftungsöffnungen dienen zur Luftzirkulation die das Gerät vor Überhitzung schützt. Sorgen Sie dafür, daß diese Öffnungen nicht abgedeckt werden.
8. Beachten Sie beim Anschluß an das Stromnetz die Anschlußwerte.
9. Die Netzanschlußsteckdose muß aus Gründen der elektrischen Sicherheit einen Schutzleiterkontakt haben.
10. Verlegen Sie die Netzanschlußleitung so, daß niemand darüber fallen kann. Es sollte auch nichts auf der Leitung abgestellt werden.
11. Alle Hinweise und Warnungen die sich am Geräten befinden sind zu beachten.
12. Wird das Gerät über einen längeren Zeitraum nicht benutzt, sollten Sie es vom Stromnetz trennen. Somit wird im Falle einer Überspannung eine Beschädigung vermieden.
13. Durch die Lüftungsöffnungen dürfen niemals Gegenstände oder Flüssigkeiten in das Gerät gelangen. Dies könnte einen Brand bzw. Elektrischen Schlag auslösen.
14. Öffnen Sie niemals das Gerät. Das Gerät darf aus Gründen der elektrischen Sicherheit nur von autorisiertem Servicepersonal geöffnet werden.
15. Wenn folgende Situationen auftreten ist das Gerät vom Stromnetz zu trennen und von einer qualifizierten Servicestelle zu überprüfen:
 - a – Netzkabel oder Netzstecker sind beschädigt.
 - b – Flüssigkeit ist in das Gerät eingedrungen.
 - c – Das Gerät war Feuchtigkeit ausgesetzt.
 - d – Wenn das Gerät nicht der Bedienungsanleitung entsprechend funktioniert oder Sie mit Hilfe dieser Anleitung keine Verbesserung erzielen.
 - e – Das Gerät ist gefallen und/oder das Gehäuse ist beschädigt.
 - f – Wenn das Gerät deutliche Anzeichen eines Defektes aufweist.
16. Bei Reparaturen dürfen nur Originalersatzteile bzw. den Orginalteilen entsprechende Teile verwendet werden. Der Einsatz von ungeeigneten Ersatzteilen kann eine weitere Beschädigung hervorrufen.
17. Wenden Sie sich mit allen Fragen die Service und Reparatur betreffen an Ihren Servicepartner. Somit stellen Sie die Betriebssicherheit des Gerätes sicher.
18. Zum Netzanschluß dieses Gerätes ist eine geprüfte Leitung zu verwenden, Für einen Nennstrom bis 6A und einem Gerätegewicht größer 3kg ist eine Leitung nicht leichter als H05VV-F, 3G, 0.75mm² einzusetzen

Table of Contents

INTRODUCTION.....	1
<i>Product Features</i>	1
<i>Applications for your DI-206</i>	3
Internet Access.....	3
Network Address Translation (NAT).....	3
LAN-to-LAN Enterprise Connections.....	3
Telecommuting Server.....	3
<i>What This Manual Covers</i>	3
<i>What This Manual Doesn't Cover</i>	4
<i>Other Resources</i>	4
<i>Packing List</i>	5
<i>Additional Installation Requirements</i>	5
INSTALLATION.....	6
Ordering Your ISDN Line.....	6
<i>The DI-206 Front Panel</i>	6
<i>The DI-206 Rear Panel</i>	7
<i>Telephone Features</i>	8
<i>Installation and Initial Configuration</i>	8
A Warning on Connection Cables.....	9
Step 1 - Setting up the Console.....	9
Step 2 - Connecting the Console to the Router.....	9
Step 3 - Connecting an ISDN Line to the Router.....	10
Step 4 - Connecting a Telephone or Fax Machine to the Router.....	10
Step 5 - Connecting Ethernet Cables to the Router.....	10
Step 6 - Powering Up Devices for Initial Configuration.....	12
Step 7 - Initial Configuration of the Router.....	12
Step 7 - Configuring the LAN Port.....	13
Step 8 - Plugging in All Devices.....	15
CONFIGURATION AND MANAGEMENT.....	16
<i>Console Program Main Menu</i>	16
<i>System Information</i>	17
<i>Interface Configuration</i>	18
LAN.....	19
ISDN.....	19
<i>Network Configuration</i>	21
IP Stack Configuration.....	22
IP Static Route.....	25
IP Networking.....	26
Router Advertisement.....	26
<i>SNMP Agent Configuration</i>	26
SNMP Community Configuration.....	27
SNMP Trap Manager Configuration.....	28
SNMP Authenticated Trap.....	28
<i>Advanced Functions</i>	29
Remote Access Configuration.....	29

DHCP Configuration	38
Filter Configuration	42
Multiple Home Configuration.....	47
Static ARP.....	49
NAT Configuration	50
Telnet/Discovery Enable	60
DNS Configuration	61
Radius Configuration	63
Multi-Link PPP Configuration.....	63
<i>Admin Configuration</i>	65
<i>System Maintenance</i>	66
System Status	66
Statistics.....	67
Runtime Tables	70
Log and Trace	73
Diagnostic	77
Software Update.....	80
System Restart.....	81
Factory Reset	82
System Settings Backup/Restore.....	82
PROM SYSTEM CONFIGURATION.....	85
System Configuration.....	85
TCP/IP Parameters Configuration.....	86
System Reset	86
Software Update.....	87
EEPROM Factory Reset	88
Execute Bootload	88
USING TELNET	90
<i>Telnet Configuration</i>	90
Using Telnet via LAN.....	90
Using Telnet via ISDN.....	90
System Timeout	91
USING RADIUS AUTHENTICATION	92
<i>Installing a RADIUS Server</i>	92
<i>Configuring the DI-206 for RADIUS Authentication</i>	92
<i>Adding Users to the RADIUS Database</i>	93
APPENDIX A - TROUBLESHOOTING	94
<i>Some Common Problems With the DI-206</i>	94
None of the LEDs are on when you power up the router	94
Connecting the RS-232 cable, cannot access the console program.....	94
<i>Problems With the ISDN Line</i>	94
<i>Problems with the LAN Interface</i>	94
Can't PING any station on the LAN	94
APPENDIX B - IP CONCEPTS.....	96
<i>IP Addresses</i>	96
IP Network Classes	96
<i>Subnet Mask</i>	97

APPENDIX C – IP PROTOCOL AND PORT NUMBERS.....	98
<i>IP Protocol Numbers.....</i>	<i>98</i>
<i>IP Port Numbers.....</i>	<i>98</i>
APPENDIX D - TECHNICAL SPECIFICATIONS.....	99
APPENDIX E – COUNTRY ID NUMBERS.....	101
APPENDIX F – CONFIGURATION FILE	102
<i>Configuration File Example</i>	<i>102</i>
INDEX.....	104

—

Introduction

Congratulations on your purchase of a D-Link DI-206 series remote access router with integrated Ethernet hub and ISDN T/A. No larger than an ordinary modem, your router offers inexpensive yet complete telecommunications and internetworking solutions for your home or branch office. It is ideal for everything from Internet browsing to receiving calls from Remote Dial-in Users and making connections to other LANs via Remote Nodes.

Distinguishing features of the DI-206 include support for a full range of networking protocols, including TCP/IP (Transmission Control Protocol/Internet Protocol, also known as IP).

This complete solution also includes remote dial-in user support, an Internet single-user account (Network Address Translation) option, extensive network management capabilities, and solid security features.

Product Features

The DI-206 router is packed with features that give it the flexibility to provide a complete networking solution for almost any small to medium-sized office environment.

Ease of Installation

Your DI-206 is a self-contained unit that is quick and easy to install. Physically, it resembles an external modem; however, it is a combination ISDN router and 10 Mbps Ethernet hub, and it uses twisted-pair Ethernet cables to connect to the host network.

Built-in Hub

As a 10 Mbps Ethernet hub, your DI-206 provides six ports for connecting standard Ethernet devices. Five ports are designed for connecting network end nodes—single-user computers, servers, bridges, other routers, etc.—through standard “straight-through” twisted-pair cables; the sixth is wired for making an “uplink” connection to another hub or switch through the same type of straight-through cable used to connect end nodes.

ISDN Basic Rate Interface (BRI)

Using a standard S/T the DI-206 supports DSS1 ISDN switches. The two ISDN B-channels can be used independently for two destinations, or they can be bundled together for one high-bandwidth connection supporting bandwidth-on-demand.

ISDN Leased Line

If the router is set up for an ISDN leased line, it can automatically initialize the leased-line connection each time it is powered up.

Standard Phone Jacks

The router is equipped with two standard phone jacks for connecting telephones, fax machines, or modems. This allows the ISDN line to be used for voice as well as data calls.

Dial On Demand

The Dial On Demand feature allows a DI-206 to automatically place a call to a Remote Node whenever there is traffic coming from any workstation on the LAN (Local Area Network) to that remote site.

Bandwidth On Demand

Your DI-206 supports bandwidth up to 128 kbps over a single ISDN BRI line. It incorporates MLPPP (Multi-Link PPP) to bundle two B channels over a BRI line. In addition, the router dynamically allocates bandwidth between the two B channels, increasing or decreasing bandwidth as needed to allow for greater efficiency in data transfer. It supports BAP (Bandwidth Allocation Protocol) and BACP (Bandwidth Allocation Control Protocol) to manage the number of links in the multi-link bundle.

Full Network Management

The DI-206 incorporates SNMP (Simple Network Management Protocol) support and menu-driven network management via an RS-232 or Telnet connection.

RADIUS (Remote Authentication Dial In User Service)

The RADIUS feature allows you to use a central external Unix or NT-based server to support thousands of users.

PPP Security

The DI-206 supports PAP (Password Authentication Protocol) and CHAP (Challenge Handshake Authentication Protocol).

RIP-1/RIP-2

Your DI-206 supports both RIP-1 and RIP-2 (Routing Information Protocol versions 1 and 2) exchanges with other routers.

DHCP Support (Dynamic Host Configuration Protocol)

DHCP (Dynamic Host Configuration Protocol) allows IP addresses to be automatically and dynamically assigned to hosts on your network.

Data Compression

The DI-206 incorporates Stac data compression and CCP (Compression Control Protocol).

Networking Compatibility

The DI-206 is compatible with remote access products from other companies such as Ascend, Cisco, and 3Com. Furthermore, they support Microsoft Windows 95 and Windows NT remote access capability.

Applications for your DI-206

Some applications for the DI-206 include:

Internet Access

Your DI-206 supports TCP/IP protocol, which is the language used for the Internet. It is also compatible with access servers manufactured by major vendors such as Cisco and Ascend.

Network Address Translation (NAT)

For small office environments, the DI-206 allows multiple users on the LAN to access the Internet concurrently through a single Internet account. This provides Internet access to everyone in the office for the price of a single user.

NAT address mapping can also be used to link two IP domains via a LAN-to-LAN connection.

LAN-to-LAN Enterprise Connections

The DI-206 can dial to or answer calls from another remote access router connected to a different LAN. The DI-206 supports TCP/IP and has the capability to bridge any Ethernet protocol.

Telecommuting Server

The DI-206 allows Remote Dial-in Users to dial in and gain access to your LAN. This feature enables users that have workstations with remote access capabilities, e.g., Windows 95, to dial in using an ISDN terminal adapter (TA) to access the network resources without physically being in the office.

What This Manual Covers

This manual is divided into eleven parts.

Chapter One, “*Introduction*,” describes many of the technologies implemented in the DI-206 as well as product features.

Chapter Two, “*Installation*,” is designed as a step-by-step guide to installing the router.

Chapter Three, “*Configuration and Management*,” provides detailed explanations for the console program that is used to setup and configure the router.

Chapter Four, “*PROM System Configuration*,” provides information on the PROM program, an abbreviated version of the console program that is used to download new software into the router in case of problems with the console program.

Chapter Five, “*Using Telnet*,” describes how to setup and use telnet to configure the router.

Chapter Six, “*Using RADIUS Authentication*,” describes how to setup and use a RADIUS server to manage user authentication and centralize passwords.

Appendix A, “*Troubleshooting*,” describes some common problems setting up the router and suggests solutions.

Appendix B, “*IP Concepts*,” gives detailed explanations and recommendations for setting up an IP network on your LAN.

Appendix C, “*IP Protocol and Port Numbers*,” lists many commonly used IP settings.

Appendix D, “*Technical Specifications*,” a list of specifications about the DI-206 ISDN router.

Appendix E, “*Country ID Numbers*,” lists country ID numbers which must be entered when setting up the ISDN line on the router. These numbers have no relation to the International Country Codes used by your telephone company.

Regardless of the application, it is important that you follow the steps outlined in Chapter 2, “*Installation*,” to correctly connect your DI-206 to your LAN. You can then refer to other chapters of the manual depending on your specific installation requirements.

What This Manual Doesn't Cover

This manual assumes that you know how to use your computer and are familiar with your communications software. If you have questions about using either one, refer to the manual for the product.

Other Resources

For more information about your DI-206 check the following sources:

- ◆ Quick Start Guide.
- ◆ Support disk containing *RouteMan*, a Windows-based configuration program.

Packing List

Before you proceed further, check all items you received with your DI-206 against this list to make sure nothing is missing. The complete package should include:

- ◆ One DI-206 ISDN router.
- ◆ One power adapter.
- ◆ One RS-232 cable.
- ◆ One unshielded twisted-pair (UTP) cable.
- ◆ One frequently asked questions (FAQ) and application notes diskette.
- ◆ One Quick Installation Guide.
- ◆ This *User's Guide*.

Additional Installation Requirements

In addition to the contents of your package, there are other hardware and software requirements you need before you can install and use your router. These requirements include:

- ◆ An ISDN line.
- ◆ Ethernet connection(s) to your computer(s).
- ◆ A computer equipped with an RS-232 port and communications software configured to the following parameters:
 - ◇ VT100 terminal emulation.
 - ◇ 9600 baud.
 - ◇ No parity, 8 data bits, 1 stop bit.

After the router has been successfully connected to your network, you can make future changes to the configuration using a Telnet client application.

Installation

This chapter outlines how to connect your DI-206 to your LAN and ISDN line. Refer to the diagrams below to identify all of the ports on your device when you make connections.

Ordering Your ISDN Line

If you do not have an ISDN line installed already, we suggest that you order it from your telephone company as soon as possible to avoid the long waiting period common when ordering a new line. Use the information in this section to place the order. If you have already installed your ISDN line, you can check the following section to make sure that you can use all the features of your DI-206.

1. Contact your local telephone company's ISDN Ordering Center.
2. Make sure DSS1 switches are available since these are the only switch types currently supported by the DI-206.
3. When the telephone company installs your ISDN line, be sure to obtain the following information:
 - ◇ ISDN switch type.
 - ◇ ISDN telephone number(s).

The DI-206 Front Panel

Names and descriptions of your router's front panel LEDs are given below:

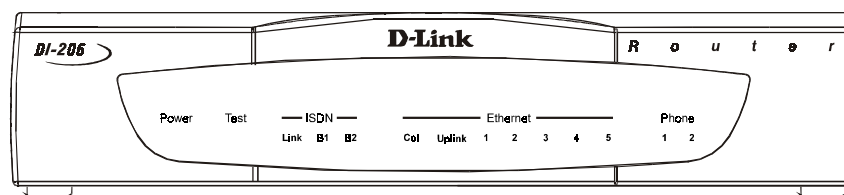

POWER— Comes on as soon as you connect the router to the power adapter and plug the power adapter into a suitable AC outlet.

TEST— Should be blinking if the router is functioning properly.

ISDN – LINK— Indicates that the router has an ISDN line connected to the ISDN interface and it has been successfully initialized.

ISDN – B1 and B2— On if there is an active ISDN session on that channel or if that channel is making or receiving a call.

ETHERNET – COL— Shines yellow when a collision occurs on the LAN, that is, when two devices have attempted to transmit at the same time.

ETHERNET – Uplink and 1 through 5— Each of these indicators shines green when a connection to an Ethernet device is detected. The indicator blinks when a transmission is received from the device, and shines yellow when the device has been partitioned, that is, temporarily isolated from the LAN because of excessive collisions (partitioning is a required capability of all Ethernet hubs).

PHONE – 1— Lights up when standard phone port 1 is in use.

PHONE – 2— Lights up when standard phone port 2 is in use.

The DI-206 Rear Panel

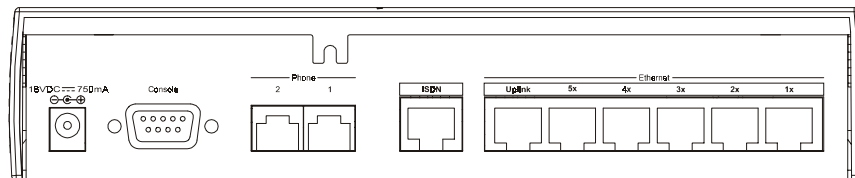

POWER — This socket is an 18 volt, 750mA power input jack. If the power adapter included with the router has been lost or misplaced, please ensure that the replacement adapter meets both the voltage and amperage requirements.

CONSOLE – This 9-pin RS-232 port is used for connecting a console or PC running a terminal emulation program. It provides out-of-band management capabilities for the initial setup and configuration of the router.

PHONE 1 and 2 – These normal telephone jacks can be used to connect telephones or fax machines to the router for use over the ISDN lines. Plug telephone devices into these jacks as you normally would into a telephone wall socket.

ISDN – This socket is used to connect the ISDN line to either an NT-1 or directly to the ISDN wall jack, depending on the type of service delivered by your phone company.

ETHERNET – The six Ethernet ports function as a normal 10 Mbps 10BASE-T Ethernet hub.

- *Uplink* – This port is used to connect the router to another hub using a straight-through twisted-pair cable.
- *Ports 1x to 5x* – These five ports can be used to connect end-stations to the router using straight-through cables.

Telephone Features

Up to two telephones can be attached to the DI-206 router via the Phone 1 and Phone 2 telephone jacks located on the rear of the router. The router enables the attached telephones to have a number of features which may or may not be found on normal telephones and are described below. Additional features which must actually be configured are described in the **Interface Configuration – ISDN** sub-menu section of this manual.

- ◆ **Hold** – This feature is very similar with and can work in conjunction with call waiting as defined in the **Interface Configuration – ISDN** sub-menu section of this manual. Press Flash 0 to place someone on hold (*Flash* is a very brief hanging up of the phone). Press Flash 2 to take the caller off hold.
- ◆ **Hold (and pick up from another location)** - Telephones connected to the router can be put on hold by pressing Flash 71, 72, 73, or 74. Press the same number to take the caller off hold and speak from another phone on your telephone network.
- ◆ **Call forwarding** – If you wish to forward incoming calls to a different telephone, press *77* and then the phone number you wish to forward the call to. All incoming calls will automatically be forwarded to the phone number entered. Press #77# to cancel call forwarding.
- ◆ **Three-person conference call** – To use this feature, conference calling must be enabled by the telephone company. After this is done, pick up a phone and place a call. After connected, press Flash 0 (refer to *call waiting* in the **Interface Configuration – ISDN** sub-menu section of this manual) and dial the second number. After connected, press flash 3 to speak to both parties at the same time. Press Flash 0 to hang up with the first party called. Press flash 1 to hang up with the second party called.
- ◆ **Call transfer** – To transfer a call to the other phone jack on the router: if using Phone 1, press flash 20. If using Phone 2, press flash 10.

Installation and Initial Configuration

This section discusses the different connections that can be made to the router when setting it up.

Initially, you will only wish to connect the console to the router in order to configure the other ports. Once that is complete, you will need to turn off the power to the router and plug in the connection cables to the other devices. Next, power on the other devices. When they have finished powering up, power on the router. Each of these steps is described in detail in the sections below. Please skip any setting adjustments that do not apply to your configuration needs.

For the initial configuration of your DI-206, you must use an RS-232 console connection, either to a computer running serial communications software or to a serial data terminal.

After the router has been successfully installed and the initial configuration is complete, you can continue to modify settings through the console, or you can change configuration settings through a remote Telnet connection or through a web browser. See the chapters entitled “*Configuration and Management*” and “*Using Telnet*” for detailed instructions on using Telnet to configure your DI-206.

A Warning on Connection Cables

ISDN and Ethernet cables are very similar to each other. It is important that you use the correct cable for each connection; otherwise, your router could be damaged.

Before connecting or disconnecting an RS-232 cable between two devices, turn both devices off to avoid any chance of damaging them.

Step 1 - Setting up the Console

The initial setup of the DI-206, requires connecting a console to the 9-pin RS-232 Diagnostic port on the router’s rear panel. A serial cable is supplied with the router in order to make this connection. A console can be a terminal, such as a VT-100, or a normal PC running terminal emulation software (such as Microsoft HyperTerminal, included with Windows). The terminal emulation software needs to be configured to the following parameters:

- ◇ VT100 terminal emulation
- ◇ 9600 baud
- ◇ No parity, 8 data bits, 1 start bit, 1 stop bit
- ◇ No flow control

Step 2 - Connecting the Console to the Router

A serial cable is included in the DI-206 package. To connect this cable, plug its nine-pin connector into the 9-pin RS-232 Diagnostic port on the router’s rear panel, then connect the other end to the serial port on the rear of your computer or data terminal.

Please make sure both machines are turned off before making this connection.

After the connection is made, first power on the console. If you are using a PC, run the terminal emulation software at this time. After the PC and the terminal emulation software are up and running, power on the router.

Using the Console

The Console Program is the interface that you will be using to configure your DI-206. Several operations that you should be familiar with before you attempt to modify the configuration of your router are listed below:

- ◆ **Moving the Cursor** Within a menu, use <tab> and arrow keys to navigate through different information fields.
- ◆ **Moving Forward to Another Menu** To move forward to a sub-menu below the current one, use <tab> or arrow keys to position the cursor on the sub-menu item and press <Enter> to view the selected sub-menu.
- ◆ **Entering Information** There are two types of fields that you will need to fill in. The first requires you to type in the appropriate information. The second gives you choices to choose from. In the second case, press the space bar to cycle through the available choices. Upon configuring all fields the sub-menu, position the cursor on SAVE and press <Enter> to save, or position the cursor on EXIT to cancel.
- ◆ **Refresh Screen** Console screens are notorious for becoming garbled. When this happens, simply press <Ctrl> + <R> to refresh the contents of the screen.

Step 3 - Connecting an ISDN Line to the Router

Your phone company will provide an S/T interface into your home or office. Plug the ISDN line from the router directly into the ISDN wall socket provided by your phone company.

Step 4 - Connecting a Telephone or Fax Machine to the Router

You can connect a regular telephone, fax machine, or modem to your router to be used for analog calls. Note that the router's other functions all work the same whether you connect an analog device or not.

To connect an analog device, just plug one end of the device's cord into one of the sockets on the back of the router marked PHONE 1 or PHONE 2.

To have incoming calls directed to a device on a PHONE jack, you must enter the telephone number for the phone in the console program under the **Interface Configuration, ISDN** submenu.

Step 5 - Connecting Ethernet Cables to the Router

Your DI-206 has six ports for connecting 10BASE-T Ethernet devices to form a LAN. The jacks for ports 1 through 5 are wired to let you connect network end nodes (computers, servers, bridges, other routers, etc.) using standard "straight-through" EIA (Electronic Industries Association) Category 3 or higher twisted-pair cables. The jack for the sixth port is labeled Uplink and is wired to let you connect to

another 10Mbps Ethernet or dual-speed hub using a straight-through cable, or an end node using a cross-wired cable.

Please refer to the following chart when deciding on the type of cable necessary for a given connection:

DEVICE	PORT USED	DEVICE BEING CONNECTED	PORT TYPE	CABLE TO USE
Router	Normal	Hub or Switch	Normal	Crossover (X)
			Uplink	Straight-Through ()
		Server (or PC)		Straight-Through ()
	Uplink	Hub or Switch	Normal	Straight-Through ()
			Uplink	Crossover (X)
Server (or PC)		Crossover (X)		

The figure below shows how to make an Ethernet connection between the router and a network end node.

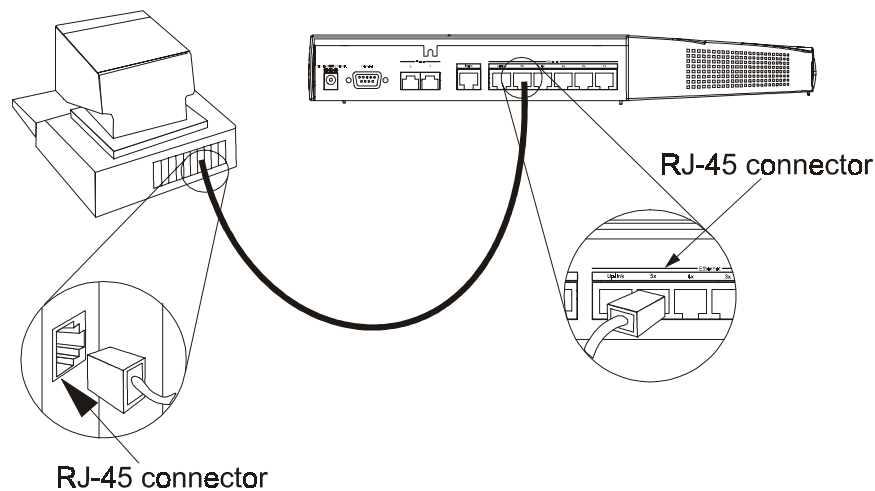

Important Notes on Ethernet Connections

Observe the following rules when connecting devices with twisted-pair Ethernet cables:

- For both end-node and uplink connections, use only EIA Category 3 or higher-grade twisted-pair data cables with RJ-45 plugs. In almost all cases, only standard straight-through cables are needed.
- Make sure no cable is more than 100 meters (328 feet) long.
- When uplinking two hubs together with a straight-through cable, use an uplink-type jack at one end, and an end-node-type jack at the other.
- If uplinking more than two hubs together, observe the 5-4-3 rule: no signal, in order to go from one end node to another, must ever pass through more than five twisted-pair cables, four repeaters (that is, hubs), and three uplink cables.

This is the maximum signal path in twisted-pair Ethernet. Also be sure never to allow a signal loop to form.

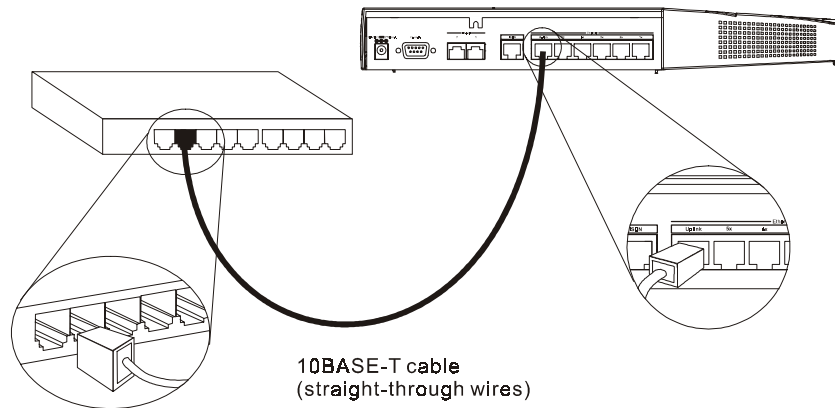

Note that you can connect an end node through the Uplink jack, but to do so you must use a cross-wired cable or cable converter.

Step 6 - Powering Up Devices for Initial Configuration

Plug in the included 18V DC, 750 mA power adapter into the power jack on the router's rear panel.

You should have now connected the RS-232 cable to the console, the ISDN phone line, one or more Ethernet cables, and the power adapter.

At this point in the installation process you can now power up the console computer, run the terminal emulation software (if necessary), and then power up the DI-206.

Step 7 - Initial Configuration of the Router

After the console is properly connected and both devices are powered on as described in the preceding sections, you should see the router run through the power on self test (POST). Finally, it will arrive at the logon screen shown below. If the login screen does not appear, press <Ctrl> + <R> to refresh the screen.

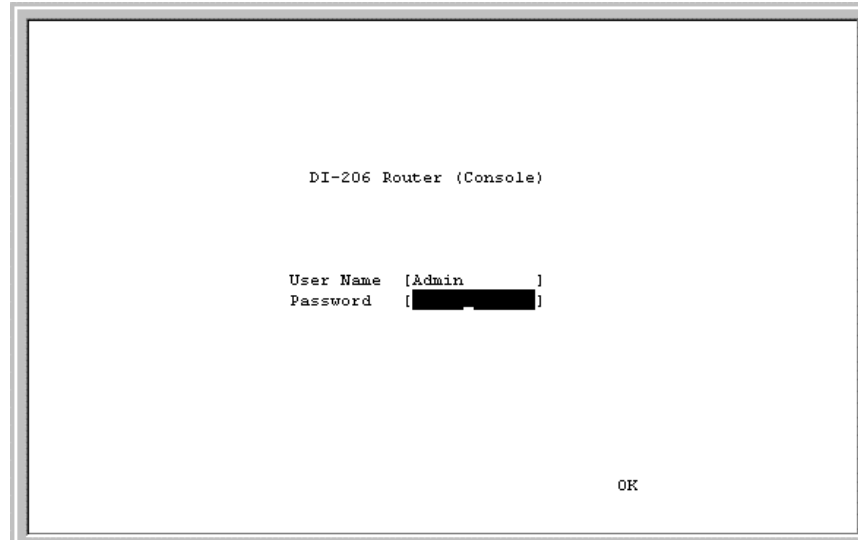

To log on to the router, use the factory set username and password “Admin” (without the quotes). Please note that the user name and password are case-sensitive.

Upon entering the username and password (using the <tab> key to jump to the next field), position the cursor on OK and press <Enter>. You will then see the following **Main Menu**:

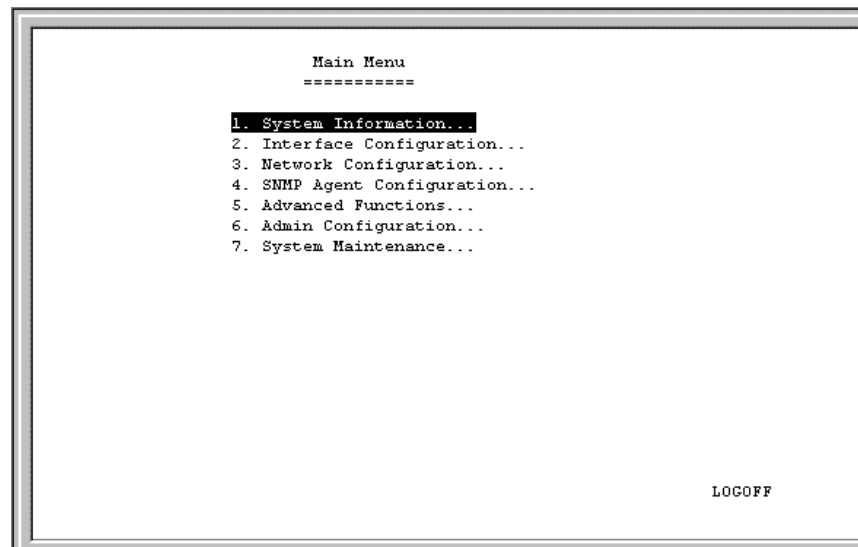

Step 7 - Configuring the LAN Port

Preparing the router for connection to a LAN only requires enabling the LAN port, enabling IP networking, assigning the LAN port an IP address and enabling Telnet (if necessary). After the LAN port is configured, all other features on the router can be configured remotely through the LAN by using the included Windows-based Router Configuration Utility or Telnet. Regardless, the router can always be configured using a console connected to the RS-232 Console port.

To configure the LAN:

1. The LAN port must be enabled in the **Interface Configuration** sub-menu.
 - ◆ Choose **Interface Configuration, LAN**.
 - ◆ Position the cursor over the State item and press <space bar>. The State will change from *Disable* to *Enable*.
 - ◆ Position the cursor on the SAVE option at the bottom of the screen and press <Enter> to save the new setting.
 - ◆ Choose Exit in the sub-menus to return to the **Main Menu**.
2. Enable IP Networking
 - ◆ Choose **Network Configuration, IP Configuration**.
 - ◆ Position the cursor over the third item IP Networking and press <space bar> to *Enable* it.
 - ◆ Position the cursor on the Save option at the bottom of the screen and press <Enter> to save the new setting.
3. Assign an IP address to the LAN port in the **Network Configuration** sub-menu of the **Main Menu**.
 - ◆ Still in **Network Configuration, IP Configuration** submenu from Step 2 above, choose **IP Stack Configuration, LAN**.
 - ◆ Enter a valid IP address for the LAN in the first item. You may also enter a Netmask if you wish. For more information about IP Addresses and Subnet masks, please refer to Appendix B, “*IP Concepts*.”
 - ◆ Position the cursor on the Save option at the bottom of the screen and press <Enter> to save the new setting.
 - ◆ Choose EXIT in the sub-menus to return to the **Main Menu**.
4. Enable the Telnet/Discovery function on the router.
 - ◆ From the **Main Menu** choose **Advanced Functions**.
 - ◆ Choose the Telnet/Discovery Enable option and then *Enable* Telnet State.
 - ◆ Position the cursor on the Save option at the bottom of the screen and press <Enter> to save the new settings.
 - ◆ Choose Exit in the sub-menus to return to the **Main Menu**.

The router can now be accessed via the LAN by Telnet, the Web-based DI-206 Router Configuration Utility (included with the router) and other SNMP management applications.

If you have any questions regarding the settings you made or other settings in the submenus, please refer to the next chapter “*Configuration and Management.*”

Step 8 – Plugging in All Devices

You can now plug in and power on all other devices connected to the router. Do not power on the router yet.

The router is now able to use the LAN ports.

The router must be further configured in order to get the built-in ISDN modem to function properly, to perform other routing functions, and to manage your IP network. This can now be done by using the console, the included Web-based Configuration Utility or Telnet.

For more information about configuring or managing the router, please refer to the next chapter, “*Configuration and Management.*”

Configuration and Management

After the initial startup (POST) test, the router will prompt you for login and password. This is the opening page of the router's out-of-band configuration program, called the Console program. The Console program is stored in the Flash memory chips in the router and the settings are written in EEPROM chips in the router. It is the most basic level for configuring and managing the router and the network to which it is connected.

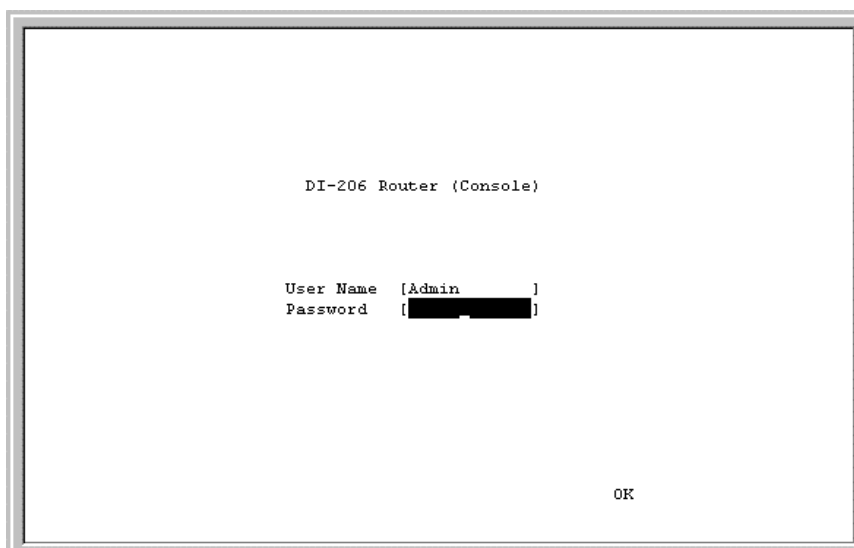

If you're starting the router for the first time, the default login and password is "Admin" – the login and password are case-sensitive, alphanumeric characters.

Note that once you are in the **Main Menu**, if there is no activity for more than 5 minutes, the router will automatically log you out. Your first endeavor should be to increase the 'timeout' time by adjusting the appropriate value in the **System Information** sub-menu.

The router can also be configured remotely through a LAN or ISDN connection by using the included Router Configuration Utility or Telnet. However, if you wish to do this, the console program must first be used to initially configure the relevant port on the router. Please see *Step 7 - Initial Configuration of the Router* on page 12 of this manual for more detailed information.

Console Program Main Menu

The **Main Menu** is shown below.

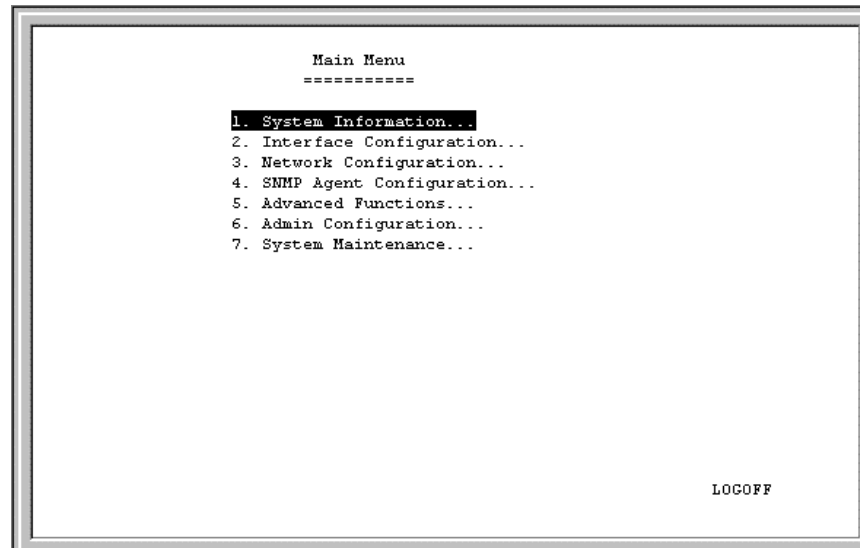

As mentioned earlier, your first endeavor should be to increase the automatic timeout. Enter the **System Information** window to do this. You will see this screen:

System Information

This menu contains administrative and system-related information.

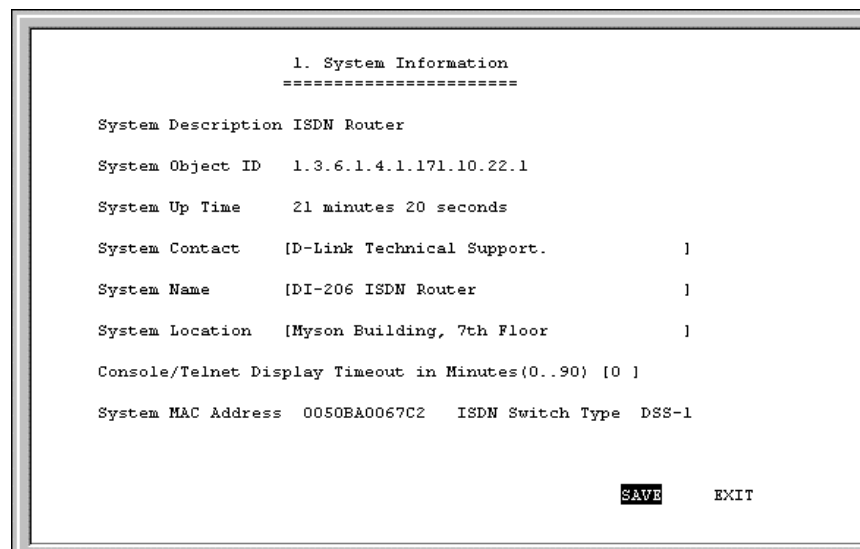

The above parameters are described as follows:

- **System Description** – This is a non-changeable, short description of the product.
- **System Object ID** – This is the enterprise-specific MIB Object ID indicating this type of router.
- **System Up Time** – Shows how long the router has been running since the last power off or reset.
- **System Contact** – Enter the name of the department or individual responsible for maintaining the router.

- **System Name** – Give the router a descriptive name for identification purposes.
- **System Location** – Enter the geographic location of the router.
- **Console/Telnet Display Timeout in Minutes(0..90)** – This is a security measure to automatically logoff from the console menu after a given idle time. Enter a timeout time between 0 and 90 minutes. Zero specifies no timeout.
- **System MAC Address** – The physical address of this router.
- **ISDN Switch Type** – The type of ISDN switch used by the telephone company that the DI-206 can communicate with. The DI-206 currently supports only the DSS1 switch type.

Interface Configuration

The second item on the **Main Menu** is the **Interface Configuration** screen, which is used to configure the LAN and ISDN interfaces:



LAN

```

LAN
=====
Description [Branch Office ]
Operation Mode 10TX HD
State <Enable >

SAVE      EXIT

```

The parameters are described below:

- **Description** – This is a user-defined, 32-character identifier used to name the LAN.
- **Operation Mode** – The LAN port is 10BASE-T only.
- **State** – This is a toggle, to *Disable* or *Enable* the LAN interface.

ISDN

```

ISDN
=====
Description [Branch Office ISDN ]
Switch Type DSS-1
B1 Channel Usage <Switch>      B2 Channel Usage <Switch>
Country ID [5 ]
ISDN Data [ ]
A/B Adapter 1 [ ]
A/B Adapter 2 [ ]
Phone 1 Call Waiting <Disable>
Phone 2 Call Waiting <Disable>
POTS Lines <Enable >
Global Reception <Enable >
Block Outgoing CLID <Disable>
Inbound Authentication <AUTH_PAP >
Call Bumping <Disable>
State <Enable >

SAVE      EXIT

```

The parameters are described below:

- **Description** – This is a user-defined, 32-character identifier used to name the ISDN.

- **Switch Type** – This parameter defines the type of ISDN service used. Currently, the DI-206 only supports DSS-1 type ISDN lines.
- **B1 and B2 Channel Usage** – This defines whether the ISDN line is a leased line or a normal switched line. If you are not using a leased line connection, set this item to Switch.
- **Country ID** – This field needs to contain the country parameter. Without this information, the router cannot establish a connection. A list of country ID numbers is located in Appendix E, “*Country ID Numbers.*”
- **ISDN Data** – This field must contain the incoming telephone number for data calls. In other words, it is your ISDN line’s data phone number.
- **A/B Adapter 1 and 2** – Enter the telephone numbers for your voice/analog lines.
- **Phone 1 and 2 Call Waiting** – If you have applied for and received call waiting capabilities for your ISDN voice lines, you must enable these settings in order for the call waiting feature to function.

There are 4 special operations for using call waiting (*flash* means a very brief hanging up of the phone. In other words, for the first option below, flash 0, click the hang up button on your phone very quickly and then press the number 0 on your telephone’s keypad):

Flash 0 – disconnect the first phone call established.

Flash 1 – disconnect the second phone call established.

Flash 2 – switch between the two phone calls.

Flash 3 – speak to both parties simultaneously (if conference calling is enabled by your phone company).

- **POTS Lines** – [Plain Old Telephone Service]. Enables or disables phone calls on the Phone 1 and Phone 2 jacks on the rear of the router.
- **Global Reception** – When this is enabled, the Phone 1 and Phone 2 jacks will receive all phone calls directed to them by the telephone company’s switch. When disabled, the router will check incoming calls to the Phone 1 and 2 jacks against the telephone numbers specified in the A/B Adapter 1 and 2 fields above.
- **Block Outgoing CLID** – When this is enabled, your ISDN data phone number and voice phone numbers will never be sent out when trying to establish a connection. Thus, even if sites being called have Caller ID, they still won’t be able to know your phone number.
- **Inbound Authentication** – This defines the authorization protocol that will be used when accepting a dial-in connection. The choices are Password Authentication Protocol [*PAP*], Challenge Handshake Authentication Protocol [*CHAP*] or *None*. PAP and CHAP do not provide a screen for users to manually enter their Username and Password – instead, this data must be entered into the dialing software before placing the call. Make sure the device dialing in is using

the same protocol as defined here. The *None* setting may be used when you do not wish dial-in users or networks to identify themselves or be subject to security.

- **Call Bumping** – This setting only takes effect when both B channels are connected and using multi-link PPP. If this is the case and call bumping is enabled, when you receive an outgoing voice call, the second B channel will be dropped (with all traffic being moved to the first B channel) and the voice call will be received. If disabled, both B channels will continue their data transmissions uninterrupted and the voice call will be ignored.
- **State** – Enables or disables the ISDN port.

Network Configuration

IP protocol configuration and static routes are configured in the **Network Configuration** sub-menu. This menu is shown below:

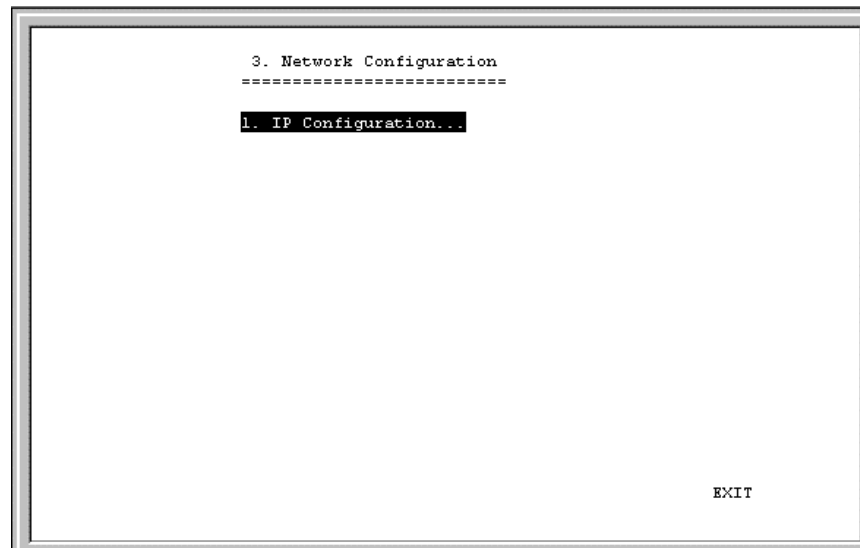

Select IP Configuration and the following screen opens:

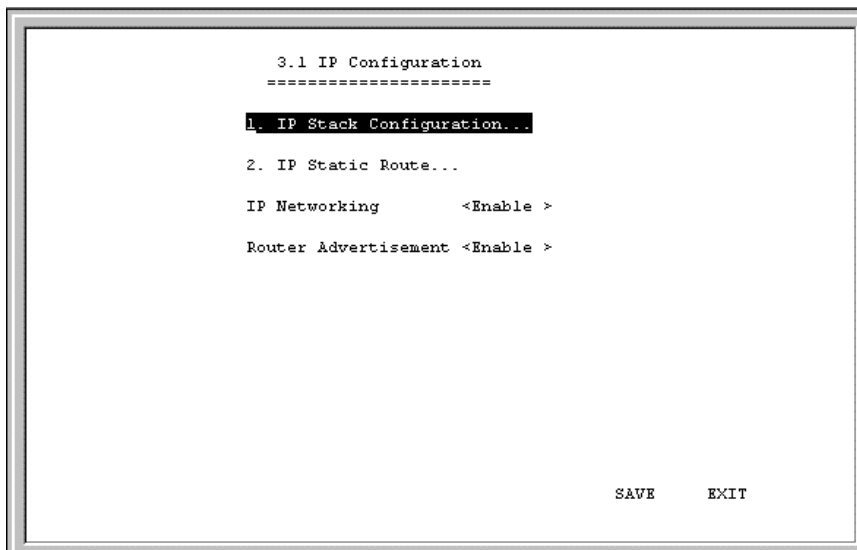

IP Stack Configuration

The network interface IP address, mask and protocols are specified in the **IP Stack Configuration** submenus. The screens for both the LAN and ISDN interfaces are shown below:

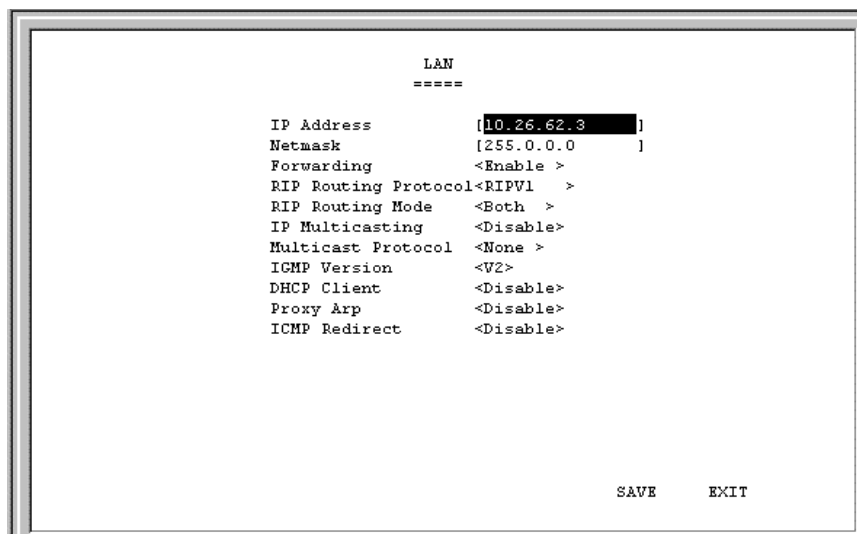

```

ISDN Link 1
=====
IP Address      [210.11.22.3 ]
Netmask        [255.255.255.0 ]
State          <IP Stack>
RIP Routing Protocol<RIPV1 >
RIP Routing Mode <None >
IP Multicasting <Disable>
Multicast Protocol <None >
IGMP Version   <V2>
RIP Spoofing   <Enable >
Proxy Arp      <Disable>
ICMP Redirect   <Disable>

                               SAVE   EXIT

```

The parameters are described below:

- **IP Address** – This is the IP address for the router on the network to which this interface is connected.
- **Netmask** – This is a 32-bit bit mask that shows how the IP address is to be divided into network, subnet and host parts. The netmask has ones in the bit positions in the 32-bit address which are to be used for the network and subnet parts, and zeros for the host part. The mask should contain at least the standard network portion (as determined by the address's class), and the subnet field should be contiguous with the network portion.
- **Forwarding (LAN)** – This enables or disables communications between this router and other router(s) on the LAN.
- **State (ISDN)** – This is a link method between this interface and adjacent router(s). The methods are described:
 1. *AUTO* – This obtains and utilizes the IP address assignment from your ISP (Internet Service Provider).
 2. *DISABLE* – This disables this interface.
 3. *IP STACK* – This enables this interface, and the IP address used will be the value of the parameter, *IP Address*.
 4. *UNNUMBER* – This utilizes a method of connecting this router with adjacent routers, without having to define an IP network prefix between them. The adjacent routers must have *UNNUMBER* capability too.
- **RIP Routing Protocol** – This is a distance vector routing protocol. RIP is an Internet standard Interior Gateway Protocol defined in RFC 1058 and RFC 1723. Routing information is sent periodically (each 30 seconds, or triggered by topology change) to an adjacent router. The adjacent router must be using the same protocol. Setting this to *RIPV1&V2* will give the router the ability to make routing information exchanges with any adjacent router.

- **RIP Routing Mode** – This parameter allows the router to specify the extent to which it partakes in the RIP on this port. The options are described below:
 1. *None* – The router will not participate in any RIP exchange with adjacent routers.
 2. *Listen* – The router will incorporate routing information from adjacent routers, but will not send its own routing table.
 3. *Talk* – The router will send adjacent routers its own routing table, but will not incorporate routing information from them.
 4. *Both* – The router will incorporate routing information from adjacent routers, and will send adjacent routers its own routing table.
- **IP Multicasting** – This feature enables or disables the router's ability to route IP Multicast packets from one interface to another (for example, from the LAN ports to the ISDN port). IP Multicasting is a bandwidth-saving method for transmitting data to more than one host. IP Multicasting is often used when sending/receiving audio or video data. When IP Multicasting is enabled, the router will search its multicast forwarding table and depending on the result of the search will either forward the packet or add the group to the table. If IP Multicasting is disabled, all multicast packets received by the router will be dropped, effectively limiting multicasting to the LAN. The router can also perform DVMRP if this feature is enabled (see Multicast Protocol below), which allows the DI-206 to share multicast information with other routers, enabling IP multicasting over the ISDN port.
- **Multicast Protocol** – If this parameter is set to None, the router will only use the Internet Group Management Protocol (IGMP), if IP Multicasting is enabled above. This effectively limits multicast data to the local network. If set to DVMRP (Distance Vector Multicast Routing Protocol), the router will also use this protocol to share its multicast information with other routers (much like RIP), in effect, enabling multicasting on the WAN (ISDN) port.
- **IGMP Version** – Configures the router to use either IGMP version 1 or 2. A major difference between the two is that version 2 allows the router to communicate multicast information with other routers (via the ISDN port), even if the other router isn't using DVMRP.
- **DHCP Client (LAN)** – This feature allows the LAN port to be assigned an IP address from a DHCP server other than the one in the router. This feature should be enabled only for special configurations (such as the presence of a cable modem on the LAN) where you wish the router to work with a device on the network that must act as a DHCP server. Otherwise, this feature should be kept disabled.
- **RIP Spoofing (ISDN)** – This feature should only be enabled if you have more than one router on your network and this router is providing your WAN connection. In this case, if the WAN connection is dropped due to inactivity and this feature is enabled, RIP packets will be sent to the other routers on the network telling them that data can still be sent to the WAN via this router. Otherwise, the other routers will learn that the WAN link has been disconnected and will no longer forward packets destined for the WAN to this router, causing

the packets to be dropped before Bandwidth on Demand has a chance to reestablish the WAN connection.

IP Static Route

A static route is a permanent entry in the routing table. Static routing provides a means of explicitly defining the next hop router for a particular destination network IP address. Each static route entry also allows for a metric (a.k.a. hop count) to be specified.

3.1.2 IP Static Route					
=====					
IP Address	Netmask	Gateway	Hops	Intf	State

1. [0.0.0.0] [0.0.0.0] [172.22.3.1	1 [1]	<ISDN L1>	<Enable >
2. [202.12.125.0] [255.255.255.0] [210.172.23.1	1 [1]	<LAN >	<Enable >
3. [202.12.124.0] [255.255.255.0] [202.12.129.1	1 [1]	<ISDN L2>	<Enable >
4. [0.0.0.0] [0.0.0.0] [0.0.0.0	1 [0]	<LAN >	<Disable >
5. [0.0.0.0] [0.0.0.0] [0.0.0.0	1 [0]	<LAN >	<Disable >
6. [0.0.0.0] [0.0.0.0] [0.0.0.0	1 [0]	<LAN >	<Disable >
7. [0.0.0.0] [0.0.0.0] [0.0.0.0	1 [0]	<LAN >	<Disable >
8. [0.0.0.0] [0.0.0.0] [0.0.0.0	1 [0]	<LAN >	<Disable >
9. [0.0.0.0] [0.0.0.0] [0.0.0.0	1 [0]	<LAN >	<Disable >
10. [0.0.0.0] [0.0.0.0] [0.0.0.0	1 [0]	<LAN >	<Disable >
11. [0.0.0.0] [0.0.0.0] [0.0.0.0	1 [0]	<LAN >	<Disable >
12. [0.0.0.0] [0.0.0.0] [0.0.0.0	1 [0]	<LAN >	<Disable >
					SAVE EXIT

The parameters are described below:

- **IP Address** – This specifies the destination network IP address (or a host, depending on the netmask) and pairs it with a gateway.
- **Netmask** – This mask shows how the destination IP address is to be divided into network, subnet and host parts. The netmask has ones in the bit positions in the 32-bit address which are to be used for the network and subnet parts, and zeros for the host part.
- **Gateway** – This is the adjacent next hop router, for which the packets, arriving to this router with this destination IP address, will be forwarded.
- **Hops** – This is an associated RIP metric that may have its value set between 1 and 15, inclusive. A metric value higher than 15 (such as 16) means that the network is unreachable.
- **Intf** – This is the network interface containing the gateway that the packets will be forwarded through.
- **State** – This enables/disables a particular entry.

IP Static Route Examples

The IP Static Route Table shown in the **IP Static Route** screen above has the first three entries configured for common implementations of static routing.

The first entry assumes that ISDN1 has a connection to the Internet and defines the default next hop router. If you use this router to connect to the Internet it is very important that you create an entry here that defines the default next hop router as your ISP. This configuration is also commonly used when RIP exchanges with other Internet routers (on ISDN1) are disabled.

The second entry shows how to configure static routes when there is another router on the LAN. The IP Address shown (202.12.125.0) is the network address for a branch office, for example. The Gateway Address (210.172.23.1) is the IP address to the LAN port on another router on the LAN that maintains an ISDN connection to the branch office.

The third entry is an example of an enterprise ISDN connection (through telephone lines) to another router, at a branch office for example. The IP Address is the network address of the branch office. The Gateway Address is the IP Address of the ISDN port on the branch office router. This configuration assumes there is a modem on ISDN2 maintaining a dial-up connection to the branch office.

IP Networking

Under the **IP Configuration** sub-menu, the IP Networking function can toggle to connect or disconnect this router from the entire IP network.

When IP Networking is disabled, all routing functions are stopped. The only IP Address the router will act on is its own, via Telnet for example.

Router Advertisement

When this option is enabled, the router will periodically send out ICMP packets that announce itself on the network. These ICMP packets are utilized by the Windows 98 or later operating system, which will automatically update the default gateway setting on the computer in which it is installed.

SNMP Agent Configuration

The Simple Network Management Protocol (SNMP), defined in STD 15, RFC 1157, is a protocol governing the management and the monitoring of IP network devices and their functions. The DI-206 supports the use of SNMP to acknowledge communication between management stations and itself. Basically, the DI-206, when connected to the network, acts as an SNMP agent, a software process that responds to queries using SNMP to provide status and statistics about the router.

Following is a description of how to configure the DI-206 for SNMP management.

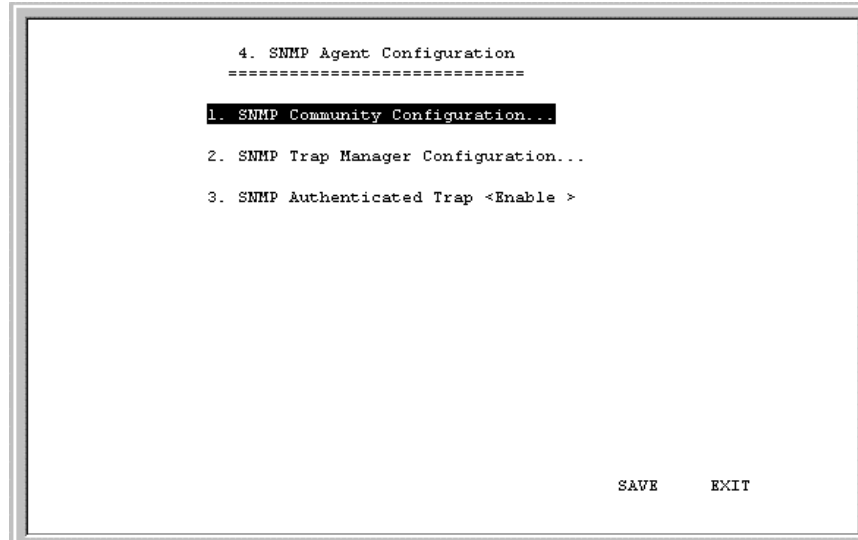

From the **Main Menu**, select *SNMP Agent Configuration*. This will bring you to the **SNMP Agent Configuration** menu, shown above.

SNMP Community Configuration

Select and enter the **SNMP Community Configuration** sub-menu. You will see the following configuration screen:

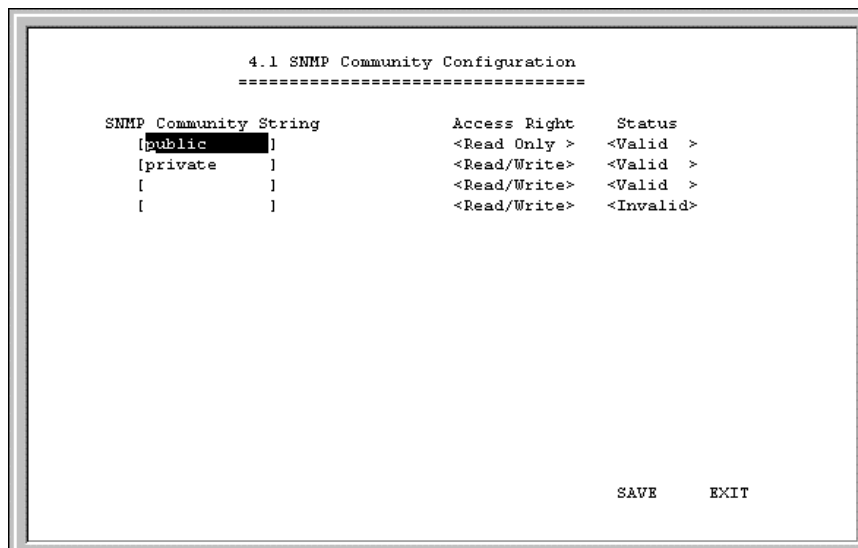

The parameters are described below:

- **SNMP Community String** – This community string is a user-defined identifying name used to group together some arbitrary set of SNMP application entities managed by the network manager.
- **Access Right** – This element of the set {*Read Only*, *Read/Write*} is called the SNMP access mode. If the SNMP Community String has an Access Right of *Read/Write*, then that Community String is available as an operand for the *get*, *set*, and *trap* operations. Otherwise, if the Community String's corresponding Access Right is *Read Only*, then it is available as an operand for the *get* and *trap* operations only.

- **Status** – This validates or invalidates the use SNMP Community String, by setting the string to *Valid* or *Invalid*. Note that setting the use of the string to *Invalid* is the same as removing the string, however, the string remains so as to be validated at an appropriate time.

SNMP Trap Manager Configuration

From the **SNMP Agent Configuration** menu, select and enter the **SNMP Trap Manager** sub-menu. You will see the following configuration screen:

IP Address	SNMP Community String	State
[0.0.0.0]	[]	<Invalid>
[0.0.0.0]	[]	<Invalid>
[0.0.0.0]	[]	<Invalid>
[0.0.0.0]	[]	<Invalid>
[0.0.0.0]	[]	<Invalid>

SAVE EXIT

The parameters are described below:

- **IP Address** – Enter the IP address of the host who will act as an SNMP Management Station. The DI-206 router will send SNMP traps to these addresses.
- **SNMP Community String** – The community string is a user-defined identifying name used to group together some arbitrary set of SNMP application entities managed by the network manager. Traps will be sent to the IP Address (previous parameter) as long as the corresponding Community String, in the Management Station's trap manager software, is the same.
- **State** – This validates or invalidates the use of the SNMP Community String, by setting the use of the string to *Valid* or *Invalid*. Note that setting the string to *Invalid* is the same as removing the string, however, the string remains so as to be validated again at an appropriate time.

SNMP Authenticated Trap

Returning to the **SNMP Agent Configuration** menu, you can *Enable* or *Disable* an authentication failure trap message being sent to the Management Station by the router. When an SNMP packet with an invalid community name is received, it will be dropped. If this parameter is enabled, a trap will be sent to the network manager; if this parameter is disabled, no trap will be sent.

Advanced Functions

The **Advanced Functions** menu contains most of the more complex configuration settings and is shown below:

```

5. Advanced Functions
=====
1. Remote Access Configuration...
2. DHCP Configuration...
3. Filter Configuration...
4. Multiple Home Configuration...
5. Static ARP...
6. NAT Configuration...
7. Telnet/Discovery Enable...
8. DNS Configuration...
9. RADIUS Configuration...
10. Multi-Link PPP Configuration...

EXIT

```

Remote Access Configuration

The **Remote Access Configuration** menu is used to set up the router for dial-in and dial-out connections over the ISDN line. An ISDN line has a D channel for establishing connections and two B (Bearer) channels, which transmit and receive the actual signals, whether voice or data. The two B channels can support two independent remote connections or be banded together using Multi-link PPP to implement Bandwidth on Demand (configured separately in the **Multi-Link PPP Configuration** menu, the last item in the **Advanced Functions** window).

The B-Channels can also carry voice and fax calls, which are routed to the telephone jacks located on the rear of the router. Please note, however, that the DI-206 can maintain only two connections at a time via the two B channels, whether the connections are voice, data, dial-in users, remote networks or a combination thereof.

Remote Operation Overview

The DI-206 is very flexible and can be configured for a variety of remote connections. Since configuring the router can be quite complex - depending on the number and type of remote connection(s) you wish to implement - we have described some of the basic functions and procedures below.

Dial-In User Connections

Dial-in users are defined as a single user on a computer, such as a person working at home, who dials into the office to use network resources. In almost all cases, a Dial-In User Profile needs to be set up for each user who will dial in to the router so the router can tailor the connection for each user. Once this is done, the remote user will

be able to use network resources as if he were connected locally. When the user dials into the DI-206, the call comes into the D-channel and after answering the phone, the DI-206:

1. Identifies the Username and Password using the authentication protocol defined in the **Interface Configuration, ISDN** submenu. The dial-in user is not prompted for this information, but must enter it into his dialing software before dialing.
2. Checks the Username and Password against those defined in the Dial-In User Profiles and Remote Network Profiles.
3. Assuming a matching Dial-In User Profile is found, the router may configure the IP address of the remote station (as defined in the Dial-In User Profile).
4. Configures a dial-in Interface (a virtual circuit) to handle the connection.
5. Establishes the connection on whichever B-channel (physical port) is open by mapping the dial-in interface to that port.
6. In the case where the Dial-In User does not need to supply a Username and Password (Auth Type is set to *None* in the **Interface Configuration** submenu) the remote computer must have its own IP address.

Remote Network Connections

Remote networks are defined as other networks (LANs) that have WAN connections using a router, Internet server, network modem or similar device (in this document however, we will assume the remote device is a router). In almost all cases, a Remote Network Profile needs to be set up for each network that will connect to the DI-206 via the ISDN lines. The Remote Network Profiles are necessary for the router to identify and tailor the connection to the remote network's router. Once this is done, a connection between the two routers can be made and computers on each network can communicate with each other.

Dial-In Network Connections

A dial-in network connection is very similar to a dial-in user connection. When the remote router dials into the DI-206, the call comes into the D-channel and after answering the phone, the DI-206:

1. Identifies the Username and Password using the authentication protocol defined in the **Interface Configuration, ISDN** submenu.
2. Checks the Username and Password against those defined in the Dial-In User Profiles and Remote Network Profiles.
3. Assuming a matching Remote Network Profile is found, the router may configure the IP address of the remote station (as defined in the Remote Network Profile).
4. Configures the specified **ISDN Interface** (a virtual circuit) using the configuration parameters defined in the **Interface Configuration** menu and the Remote Network Profile to handle the connection.
5. Establishes the connection on whichever B-channel (physical port) is open by mapping the dial-in interface to that port.

Dial-Out Network Connections

Dial-out network connections are much different than dial-in connections.

When a packet on the LAN reaches the router, the DI-206 will:

1. Check its routing table to try to identify where this packet should go. It looks for two variables in the routing table, Gateway address and Interface. There are four possible results:
 - I. In the case where the destination resides in the same IP network on the LAN, the routing engine never acts on the packet and it is sent directly to the destination through the built-in hub.
 - II. In the case where the destination resides on a different IP network on the LAN (which can happen when Multiple Home Configuration is set up), the router will send out an ARP request to obtain the MAC address of the destination computer (or router) and deliver the packet. Note that defining Static ARPs can speed up delivery since the router won't need to send out an ARP request.
 - III. In the case where the router finds a match in the routing table (which includes IP Static Routes), it uses the Gateway address and Interface numbers to identify the correct Remote Network Profile to use to dial out. From the Remote Network Profile, the router gets the telephone number and other information and dials out, establishes a connection and delivers the packet. If you have a connection to the Internet, it is very important that you define the default next hop router in the **IP Static Routes** submenu of the console program as your ISP (see the *IP Static Routes* section of this manual for more detailed configuration information). This is because if a user on your LAN makes a request to download a web page for the first time, for instance, since it is the first time, the DI-206 will not have any record of the web page's IP address. If no default next hop router is defined, the request will be dropped and the user will get a 'Destination Unreachable' error message. However, if a default next hop router is defined in the IP Static Routes, the DI-206 will pass this request on to the ISP (the request will go through) and the user will receive the web page.
 - IV. In the case where there is no match for the destination IP address in the routing table, and no default next hop router is defined, the packet will be dropped and no action will be taken.

The **Remote Access Configuration** submenu is shown below. All items in the submenu are described as follows.

```
5.1 Remote Access Configuration
=====
1. Dial Configuration...
2. Dial-In User Profile...
3. Remote Network Profile...

EXIT
```

Dial Configuration

You can configure the two ISDN interfaces on your DI-206 to dial-out only when a packet is forwarded to that interface, and hang up after all data has been transferred and the link is idle. This can be used to lower the cost of an unpopular link or used as a backup link to your ISP. This feature is commonly called “Dial on Demand”. ISDN interfaces can also be configured here to receive calls from dial in users and other networks, called “Remote Access”. Please note however, that in all cases, after configuring the ISDN Links in the **Dial Configuration** submenu, they must be further configured in the **Dial-In User Profile** submenu or **Remote Network Profile** submenu.

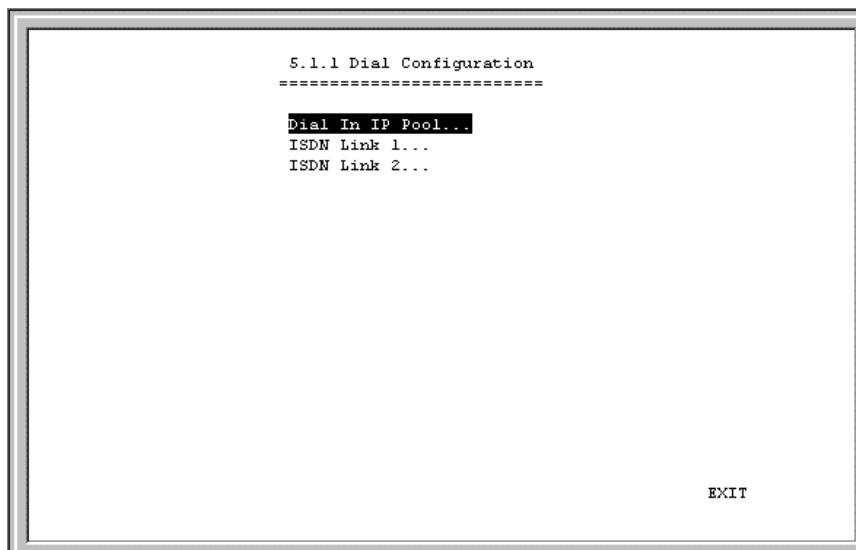

Dial In IP Pool

The dial in IP pool allows you to define a range of IP addresses that will be reserved for and assigned to dial-in users.

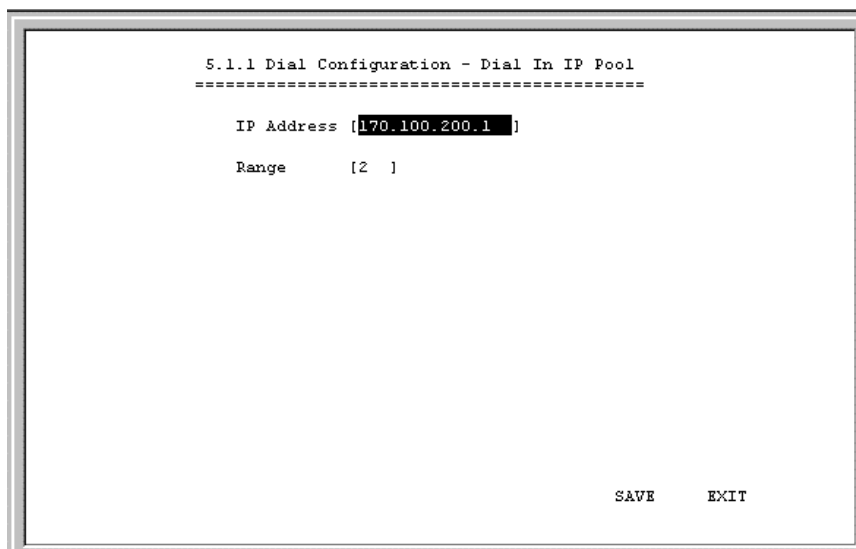

The items are described as follows:

- **IP Address** – This is the first IP Address that will be assigned to a dial-in user.
- **Range** – This is the number of IP Addresses that can be assigned. In the window shown above, dial-in users will be assigned the IP Addresses 170.100.200.1 or 170.100.200.2 (only two are necessary since the router used in the examples has only two ISDN ports).

ISDN Link 1

This submenu contains a number of settings (shown below) which allow you to configure the router to dial out.

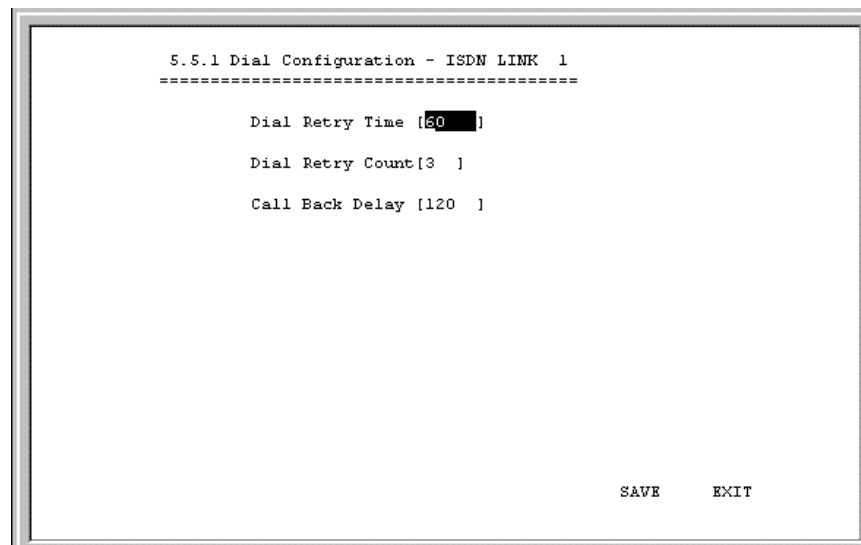

The parameters are described below:

- **Dial Retry Time** – This is the time (in seconds) the router will wait before the next dial attempt.
- **Dial Retry Count** – This is the specified maximum number of dial attempts the router will make when trying to establish a connection on this interface.
- **Call Back Delay** – This is the time (in seconds) the router will wait before a remote user is called back.

Dial-In User Profile

The Dial-In User Profile is used to configure the DI-206 for single users (for example a person working at home) to dial in to the router and gain access to the network. At least one User Profile must be configured for each user who will dial in (in conjunction with Dial Configuration settings). Please note that WAN connections to computers on other networks must be defined in the **Remote Network Profile** submenu.

Up to eight users can be set up to dial in to the router. However, more dial-in users can be accommodated by using a Radius server as described in the *Radius*

Configuration section of this manual. Please note that when a Radius server is being used, the Dial-in User Profiles will be disabled.

The **Dial-In User Profile** submenu appears below:

```
5.1.2 Dial-In User Profile
=====
1. Charlie
2.
3.
4.
5.
6.
7.
8.

EXIT
```

Select a dial-in user from the screen above.

```
Name [Charlie ]
Password [ ]
Rem CLID [5550069 ]
Default IP [10.201.22.5 ]
IP Address Supply <Default>
Call Back <Disable>
  Phone Number Supplied by <Router>
  Phone Number [ ]
Idle Time [0 ]
State <Enable >

SAVE EXIT
```

The parameters in the above window are described as follows:

- **Name** – The maximum length is 64 characters. This username is for password challenges (authentication). The user dialing in must supply this username in order to be allowed access to the router.
- **Password** – This is the password associated with the above Name field.
- **Rem CLID** – Remote Caller ID. This is the telephone number of the Remote User and is used for security. When a phone number is entered in this field, the router will make sure that the incoming call is coming from the same phone number as the one defined here. In other words, the remote user can only be

calling from the telephone number defined here, otherwise the call will not be accepted. This function is disabled if the field is left blank.

- **Default IP** – This is the IP address that will be assigned to the dial-in user when the IP Address Supply setting below is set to Default. Assigning an IP address to the remote computer ensures that the IP address does not clash with other IP addresses on your network.
- **IP Address Supply** – This field defines how the remote user will obtain an IP address. The choices include:
 - Default* – Uses the Default IP address defined above,
 - Dynamic* - Taken from the Dial In IP pool, or
 - None* - The remote user supplies his own IP Address.
- **Call Back** – This field determines if the router will allow call back to the Remote Dial-In User upon dial-in. If this option is enabled, the router will be able to call back to the Remote Dial-In User if they request it. In such a case, the router will disconnect the initial call from this user and dial back to the specified call back number. The default is no call back.
- **Phone Number Supplied by** – Toggle between *Router* and *Caller*.
- **Phone Number** – If *Router* is selected above, then this phone number is usually provided by the person who initially set up the router. If *Caller* is selected, you must enter the phone number that will be called back yourself.
- **Idle Time** – This is the elapsed time (in seconds) since the last valid or active packets have gone through the router. This setting will trigger the router to disconnect this interface when it is reached.
- **State** – Enables or disables this User Profile.

Remote Network Profile

The Remote Network Profile is used to configure the router for ISDN connections to other networks. In practice, the DI-206 will either dial-out to or receive incoming calls from another router, the 'gateway' to the other network.

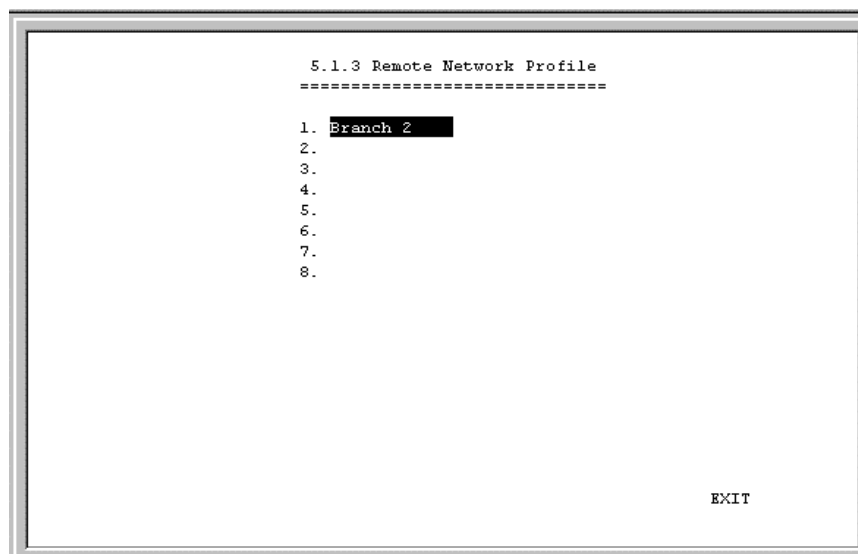

Select the desired entry from the screen above:

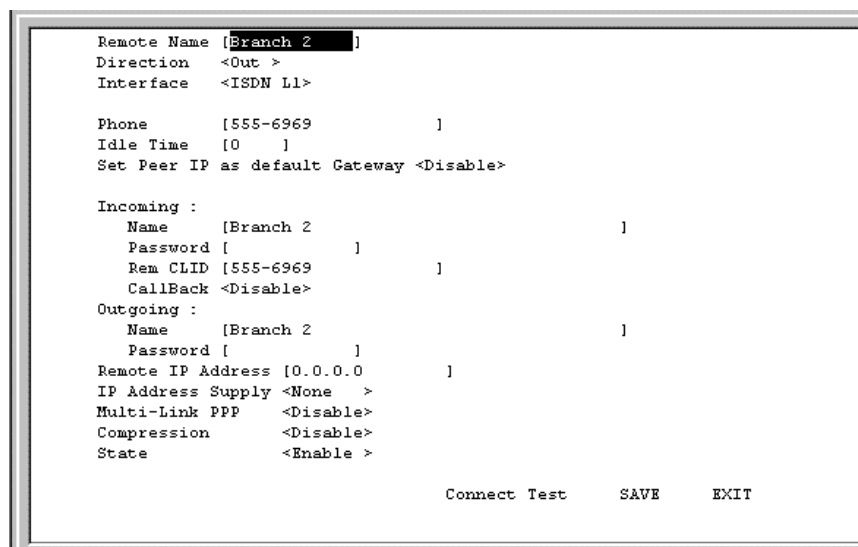

The parameters in the above window are described as follows:

- **Remote Name** – Name for the remote network that the DI-206 is being set up to connect with.
- **Direction** – Dial-[*In*], dial-[*Out*], or [*Both*]. This field defines whether the router on the other network will dial-[*In*] to the DI-206 to establish a connection, the DI-206 will dial-[*Out*] to the other network, or a connection can be established [*Both*] ways.

When this is set to *In*, the DI-206 will only establish a connection with the other network by receiving calls on the ISDN port specified in the Interface field below. Also, the incoming calls will be subject to the Name, Password and Rem CLID fields in the Incoming section below.

When this is set to *Out*, the router will only make calls on the ISDN interface specified in the Interface field below. Also, the outgoing calls will be subject to the Name, Password and Phone Number fields in the Outgoing section below.

When set to *Both*, the dial in and dial out conditions described above will both be observed.

- **Interface** – ISDN Link 1 [*ISDN L1*] or ISDN Link 2 [*ISDN L2*]. This field is used to assign a remote network to a logical (virtual) interface called a virtual circuit. More than one remote network can be configured to use the same interface, but they cannot be connected at the same time. Thus, if you wish to have two WAN connections operate simultaneously, make sure they are configured on different interfaces. On the other hand, if you have two dial-out remote network profiles but wish to keep one line always open for dial-in users, make sure the two dial-out profiles use the same interface. In this case, the two profiles will share the same interface; the second one using it after the first one's idle time has expired and it has relinquished it.
- **Phone** - This is the telephone number that will be dialed to make the outgoing connection.
- **Idle Time** – This is the elapsed time (in seconds), of inactivity, that will trigger the router to disconnect this interface.
- **Set Peer IP as Default Gateway** – When enabled, this feature sets the IP address of the remote device as the default gateway (default next hop router) for all packets not found in the routing table. This option should be enabled for the ISDN circuit (ISDN1 or ISDN2) that is used to connect to the Internet. Also, if the Peer IP is set as the default gateway here, you still need to define a static default route in the **Network Configuration, IP Static Route** submenu, but you don't need to designate a gateway IP address for the static route (the routers will automatically negotiate and adjust the gateway IP setting accordingly). And also make sure that the Remote IP Address in the *Remote Networks Profile* is set to 0.0.0.0. Note that only one ISDN circuit should be connected to the Internet, and only one ISDN circuit (the same one) should be the default gateway.
- **Incoming**
 - **Name** – The maximum length is 64 characters. This username is for password challenges (authentication). The user dialing in must supply this username in order to be allowed access to the router.
 - **Password** – This is the password associated with the above Name field.
 - **Rem CLID** – Remote Caller ID. This is the telephone number of the Remote User and is used for security. When a phone number is entered in this field, the router will make sure that the incoming call is coming from the same phone number as the one defined here. In other words, the remote user can only be calling from the telephone number defined here, otherwise the call will not be accepted. This function is disabled if the field is left blank.
 - **Call Back** – This field determines whether the router calls back after receiving a call from this Remote Network Profile. If this option is enabled,

the router will disconnect the initial call and call back to the phone number that you provide. Note that this field will be valid only if the Direction setting above is *Both*.

- **Outgoing**

- **Name** – The maximum length is 64 characters. Spaces and punctuation are not usually accepted. This username is for password challenges (authentication) which are automatically handled by the router when dialing out. The DI-206 will use PAP and CHAP (whichever works) to make the connection.
- **Password** – This is the password associated with the above Name field.
- **Remote IP Address** – This is the IP address that will be assigned to the dial-in network when the IP Address Supply setting below is set to Default. Assigning an IP address to the router dialing in ensures that the IP address does not clash with other IP addresses on your network. For dial out connections utilizing dial on demand, the IP address of the remote router needs to be entered here so the router knows which remote network to establish a connection with to deliver the packet.
- **IP Address Supply** – This field defines how the router will assign an IP address to a device dialing in. The choices include:
 - Default* – Uses the Remote IP address defined above,
 - Dynamic* - Taken from the Dial In IP pool, or
 - None* - The remote user supplies their own IP Address.
- **Multi-Link PPP** – Enables/disables multi-link PPP on this port. Individual ISDN ports can be set to join the MLPPP bundle by enabling Multi-Link on each port. When enabled, the port will join the MLPPP bundle. Please note that the DI-206 contains only one MLPPP bundle. All ports taking part in MLPPP, even the first or primary port which initially establishes the connection, must have Multi-Link enabled. The ISDN port that first established the connection is the Primary ISDN Port and will not disconnect due to a BOD Low Threshold event, but is subject to Dial on Demand (DOD) settings.
- **Compression** – Enables or disables Stac compression. This is an industry standard using a 4:1 compression scheme. When enabled, the router will try to use Stac compression on the designated ISDN port whenever possible. If the destination device is not capable of using Stac compression, the two devices will still communicate, albeit without using Stac compression. When disabled, Stac compression will never be used on this port.
- **State** – Enables or disables this Remote Network Profile.

Select Connect Test at the bottom of the screen to test if your setup is correct.

DHCP Configuration

The DI-206 Router implements the Dynamic Host Configuration Protocol (DHCP), which allows the entire IP network to be centrally managed by the router. It does this by assigning IP addresses and configuration parameters to hosts as they are powered

on and come onto the network. This can be a great help for network administration since many administrative tasks such as keeping track of each computer's IP address are handled by the router. The DI-206 can implement DHCP in one of the two ways shown below:

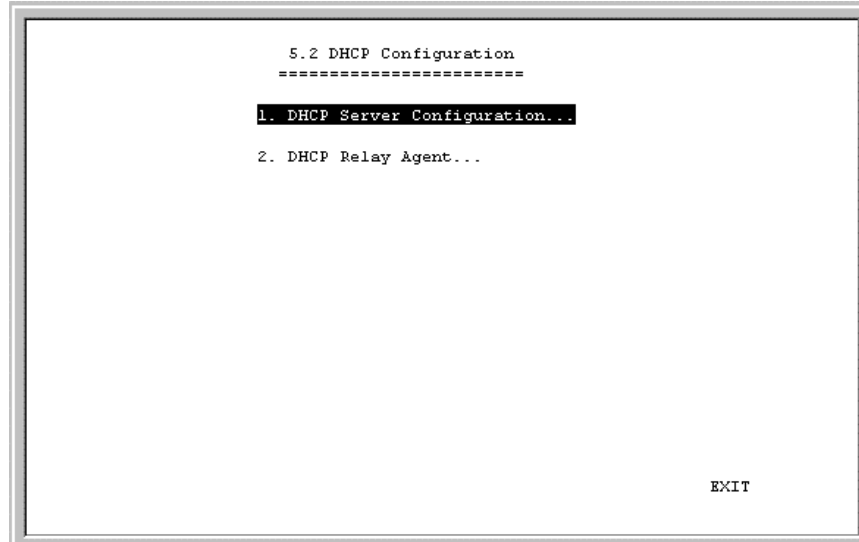

DHCP Server Configuration

When acting as a DHCP server, the DI-206 will manage many of the IP network parameters. The DI-206 will never assign a broadcast or network IP addresses to hosts, even if such an address is included in the specified range. The following is the **DHCP Server Configuration** screen:

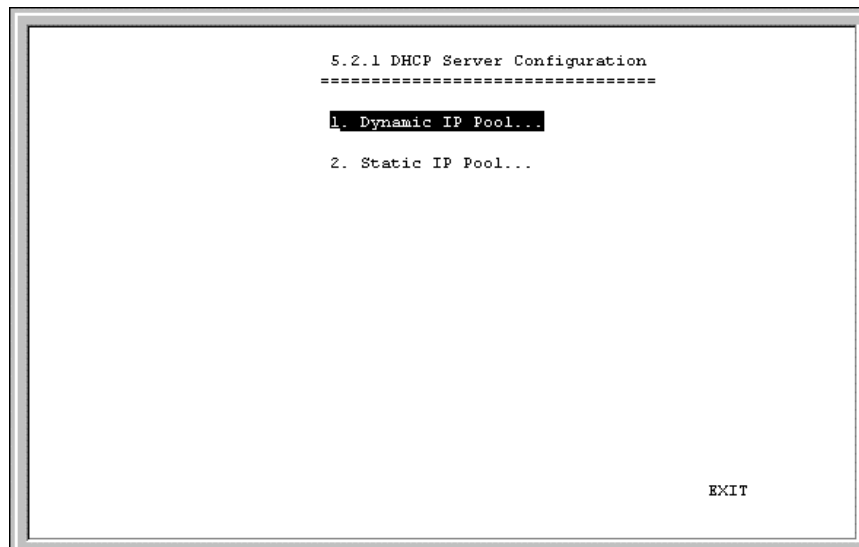

Dynamic IP Pool

The **Dynamic IP Pool** screen shown below contains the parameters that the router can set on the hosts. Please note that the Dynamic IP Pool cannot be enabled when the DHCP Agent feature is enabled.

```
5.2.1.1 Dynamic IP Pool
=====
IP Address  [202.93.47.1 ]
Range       [100 ]
Netmask     [255.255.255.0 ]
Gateway     [202.93.47.254 ]
Lease Time  [72 ]
DNS IP      [140.113.1.1 ]
WINS IP     [0.0.0.0 ]
Domain Name [dlink.com ]
State       <Disable>

                SAVE      EXIT
```

The parameters are described below:

- **IP Address** – This is the base (starting) address for the IP pool of IP addresses to be assigned.
- **Range** – This is the range of contiguous, IP addresses, above the base IP Address above. In the above example, the IP addresses assigned host computers as they come onto the network would be 202.93.47.1, 202.93.47.2 ... 202.93.47.100.
- **Netmask** – This mask informs the client, how the destination IP address is to be divided into network, subnet and host parts. The netmask has ones in the bit positions in the 32-bit address which are to be used for the network and subnet parts, and zeros for the host part.
- **Gateway** – This specifies the Gateway IP Address that will be assigned to and used by the DHCP clients.
- **Lease Time** – This specifies the number of hours a client can lease an IP address, from the dynamically allocated IP pool. The maximum value is 65535 and a value of 0 means the lease is permanent.
- **DNS IP** – This specifies the Domain Name System server, used by the DHCP clients using leased IP addresses, to translate hostnames into IP addresses or vice-versa.
- **WINS IP** – This specifies the IP address of the Windows Internet Naming Service server. This server has software that resolves NetBIOS names to IP addresses.
- **Domain Name** – This is the common suffix, shared by networked hosts, used to represent a common network domain.
- **State** – This enables or disables the dynamic IP Pool function.

Static IP Pool

The Static IP Pool configuration functions in much the same way as the Dynamic IP Pool configuration. The only difference is that a particular IP address can be assigned to a particular host. This is used for hosts such as servers that need to have static IP addresses to function properly or to make them accessible to remote users. The host is identified by the MAC address of its NIC, which must be entered on this screen.

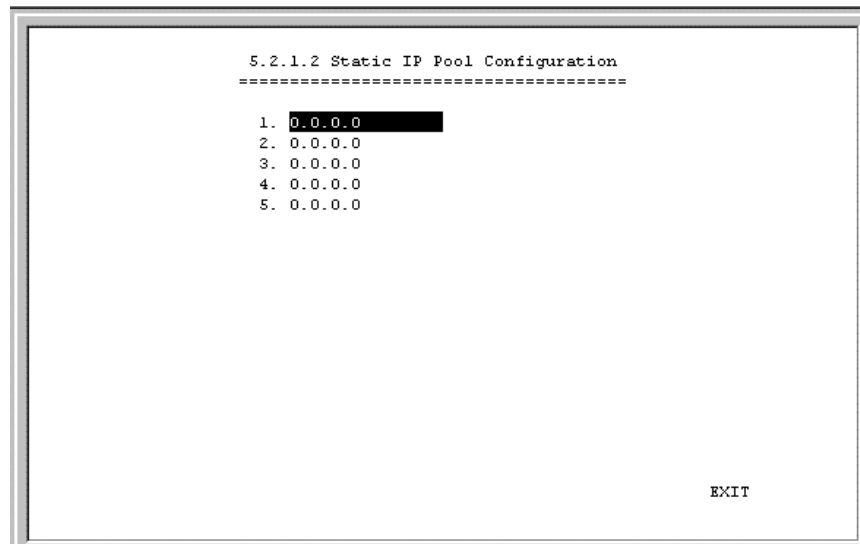

Select an entry from the screen above and press <Enter>. The following screen appears:

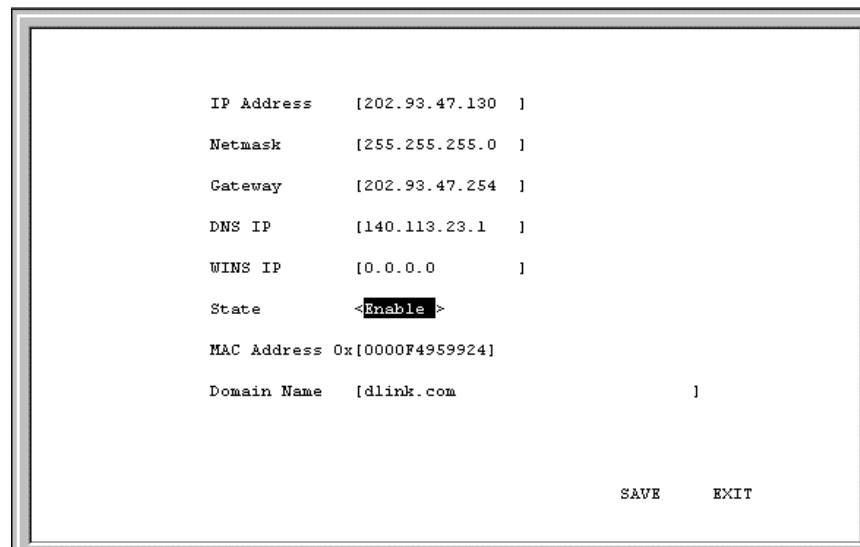

The parameters above are described below:

- **IP Address** – This is the static IP address to be assigned.
- **MAC Address** – This specifies the physical address of the particular host that will receive the above IP address.

All other parameters (Netmask, Gateway, DNS IP, WINS IP, State, & Domain Name) are identical to those in **Dynamic IP Pool** screen in the previous section.

DHCP Relay Agent

The DHCP Relay Agent feature allows the DI-206 to act as a go-between for a remote DHCP server assigning IP addresses to local clients. This can be useful if you wish to have all IP addresses in your company, including those in branch offices, assigned from a DHCP server centrally located at your headquarters, for example.

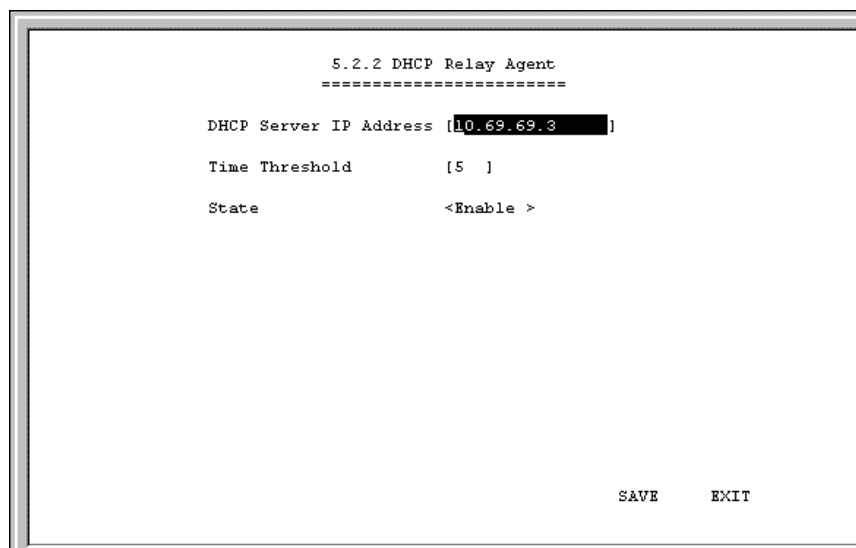

Items are described as follows:

- **DHCP Server IP Address** – This is the IP address of the remote DHCP server. When a local computer powers up and sends a DHCP request for an IP address, the DI-206 will forward the request to the address specified here.
- **Time Threshold** – This specifies the maximum amount of time (in seconds) since the host began requesting an IP address. If the value define here is exceeded, the relay agent will not pass along the request from the host.
- **State** – Enables or disables the DHCP Relay Agent function.

Filter Configuration

Your DI-206 uses filters (configurable at two layers) to screen packet data, and apply a routing decision. There are two methods for configuring filters: you can configure a filter at the network layer (IP filter) to restrict access between networks and reduce unnecessary internetwork traffic; and you can configure a filter at the data-link layer (a general filter) to provide a protocol independent filter.

Good knowledge of network protocols is required to configure a specific filter appropriately. It is important for the router to operate correctly, therefore, necessary packets must be allowed to pass through the filters. In other words, do not attempt to configure filters on a utilized router unless you understand what you are doing.

The following section describes how to configure the router filter parameters.

Configuring a Filter Set

Under the **Advanced Functions** menu, select *Filter Configuration*. You will see the following screen:



The three sub-menus are described as follows:

- **Filter State of Interface** – This is used to choose the default, routing decisions for packets, not meeting the criteria for specific filters.
- **Layer 2 Filter** – This is a data-link layer (protocol independent) filter. Foreknowledge of the specific protocol, used on the interface (LAN or WANs), is needed to make effective use of this filter.
- **IP Filter** – This is an IP protocol specific filter, allowing you to, among other things, prohibit specific packets from entering the LAN. Alternatively, you can set up filters that allow certain types of IP packets to enter the LAN.

Filter State of Interface

The **Filter State of Interface** sub-menu lets you disable a filter, or, for packets that have not met the corresponding criteria, to forward or drop packets.

```
5.3.1 Filter State of Interface
=====
Layer 2 Filter  IP Filter
-----
LAN             <Disable>     <Disable>
ISDN Link 1    <Disable>     <Disable>
ISDN Link 2    <Disable>     <Disable>
Dial-In        <Disable>     <Disable>

SAVE          EXIT
```

Each decision on handling packets is described below:

1. *Disable* – Will not apply a filter.
2. *Forward* – This allows the routing of a packet, even though it has not met the criteria of the corresponding filter.
3. *Drop* – This drops (doesn't allow routing for) a packet that has not met the criteria for the corresponding filter.

Layer 2 Filter

The **Layer 2 Filter** sub-menu contains a protocol independent (data-link layer) filter. Foreknowledge of the specific protocol used on the interface (LAN or WANs) is needed to make effective use of this filter.

```
5.3.2 Layer 2 Filter
=====
1. [REDACTED]
2.
3.
4.
5.
6.
7.
8.
9.
10.
11.
12.

EXIT
```

Select an entry above and then press <Enter>. The following screen appears:

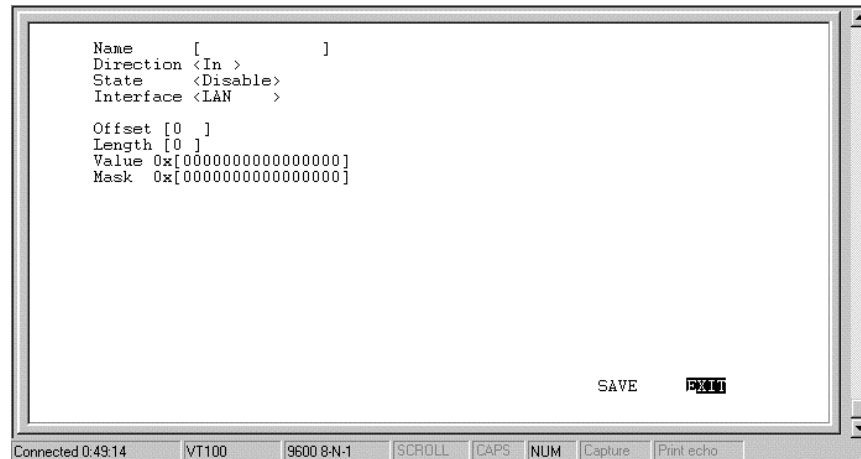

The parameters of a filter are described below:

- **Name** – This is a 12 character (maximum), alphanumeric, user-defined name, used to identify the filter.
- **Direction** – This defines the direction of the frame relative to the Interface parameter below.
- **State** – This is used to choose the routing decision applied to the frame. The three decisions are described:
 1. *forward* – This allows the routing of the frame, if it has met the criteria of the corresponding filter.
 2. *drop* – This drops (doesn't allow routing for) a specific frame that has met the criteria of the corresponding filter.
 3. *disable* – This does not apply the protocol independent filter.
- **Interface** – This applies the filter to a specific interface, either LAN or one of the ISDN interfaces.
- **Offset** – This defines the reference byte for the Length parameter (described below). The Offset is the number of bytes (octets) from the beginning of the first byte of the frame header, immediately after the preamble. The range of the offset parameter is from 0 to 255 octets. The first byte in a packet has an offset 0.
- **Length** – This is the number of bytes (octets) from 0 to 8 to compare from the offset value (the Offset reference byte).
- **Value** – This is a 16 digit, hexadecimal field, defining the actual bit values used to compare with the frame data, at the specified (Offset) position.
- **Mask** – This is a 16 digit, hexadecimal bit mask, used as an operand in the bit-wise AND operation that will be applied to the Value parameter.

IP Filter

The IP Filter is specifically an IP protocols filter, allowing you to, among other things, firewall your network, prohibiting specific packets from entering or going out

from your network. It is necessary to have good knowledge of IP protocol before effectively configuring this filter.

```

5.3.3 IP Filter
=====
1. [REDACTED]
2.
3.
4.
5.
6.
7.
8.
9.
10.
11.
12.

EXIT

```

Select an entry above and then press <Enter>. The following screen appears:

```

Name      [ [REDACTED] ]
Direction <In >
State     <Disable>
Interface <LAN >

Protocol Type  [6 ]
Src IP        [0.0.0.0 ]
Src Netmask   [0.0.0.0 ]
Src Port      [0 ]
Src Port Operation <None>

Dst IP        [0.0.0.0 ]
Dst Netmask   [0.0.0.0 ]
Dst Port      [0 ]
Dst Port Operation <EQ >

ICMP Type     [1 ]
ICMP Code     [0 ]
TCP Flag      0x[1 ]

SAVE      EXIT

```

The IP Filter parameters are described below:

- **Name** – This is a 12 character (maximum), alphanumeric, user-defined name, used to identify the filter.
- **Direction** – This defines the direction of the packet relative to the Interface parameter below.
- **State** – This is used to define the routing decision applied to the packet. The three routing decisions are described:
 1. *forward* – This allows the routing of the packet, if it has met the criteria of the corresponding filter.

2. *drop* – This drops (doesn't allow routing for) a specific packet that has met the criteria of the corresponding filter.
 3. *disable* – This does not apply the IP filter.
- **Interface** – This applies the filter to a specific interface, LAN or one of the ISDN interfaces.
 - **Protocol Type** – This is a protocol identifier, as assigned by the Internet Assigned Numbers Authority (IANA). The values of this identifier are described in RFC-1700. This router supports the following:
 - 1* – This is Internet Control Message (ICMP), defined in RFC 792.
 - 6* – This is Transmission Control (TCP), defined in RFC 793.
 - 17* – This is User Datagram (UDP), defined in RFC 798.
 - **Src IP** – This is the source address in the IP header of this packet.
 - **Src Netmask** – This mask is bit-wise AND'd with the source IP address and bit-wise AND'd with the IP address of the incoming interface. The two results are then compared.
 - **Src Port** – This is the source port, in the TCP or UDP header, of the packet.
 - **Src Port Operation** – This comparison operation is applied to the source port (the *Src Port* parameter) value, of the TCP or UDP header.
 - **Dst IP** – This is the destination address in the IP header of the packet.
 - **Dst Netmask** – This mask is bit-wise AND'd with the destination IP address and bit-wise AND'd with the IP address of the incoming interface. The two results are then compared.
 - **Dst Port** – This is the destination port, in the TCP or UDP header, of the packet.
 - **Dst Port Operation** – This comparison operation is applied to the destination port (the *Dst Port* parameter) value, of the TCP or UDP header.
 - **ICMP Type** – This is the type field, in the ICMP header, used to identify a particular ICMP message.
 - **ICMP Code** – This is the code field, in the ICMP header, used to further specify the ICMP type.
 - **TCP Flag** – This is a hex number, representing the six flag bits in the TCP header. The value range is from 0 to 3F.

Multiple Home Configuration

Besides the IP address assigned to the LAN interface in the **Network Configuration** menu, the LAN may have up to 3 additional IP interfaces. These additional IP interfaces are referred to as MIP1 to MIP3. This type of configuration is known as a multiple home configuration.

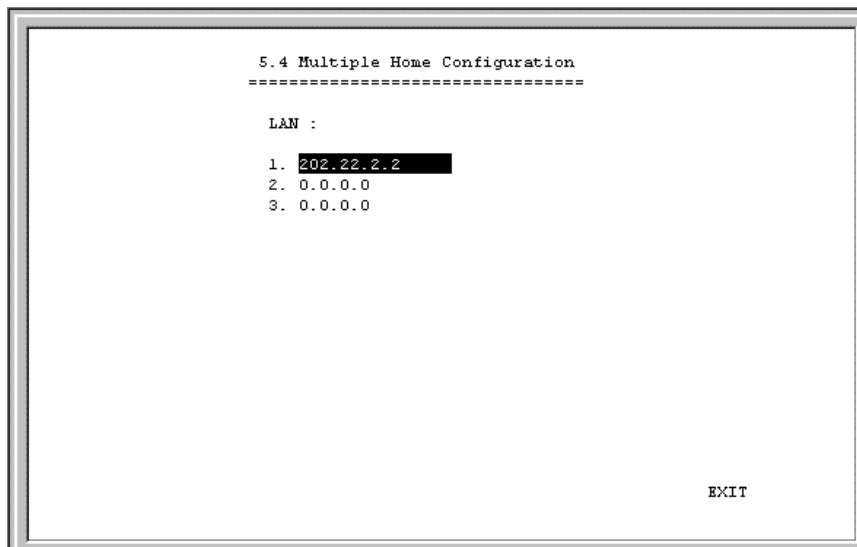

Multiple Home can be demonstrated by this example:

A company has 625 users (computers) all connected to one physical network using Ethernet. However, the company only has one Class C IP network address, 202.100.160.0. This network address will only support 254 users. To solve the shortage of IP address problem and to plan for future growth, the company applies for and receives two more Class C IP network addresses, 203.101.161.0 and 204.102.162.0. This gives the company a total of $254 \times 3 = 762$ IP Addresses, which it assigns to the computer users, with a few left over for future needs. Due to the nature of IP networks, however, the users in one IP network domain (202.100.160.0, for example) cannot communicate with users on a different IP domain (203.101.161.0). Multiple home solves this problem. When you register the additional IP network addresses in the Multiple Home Configuration menu on the router, the router will route data between the three IP networks using the single LAN.

In this router, multiple home configurations only apply to the LAN interface.

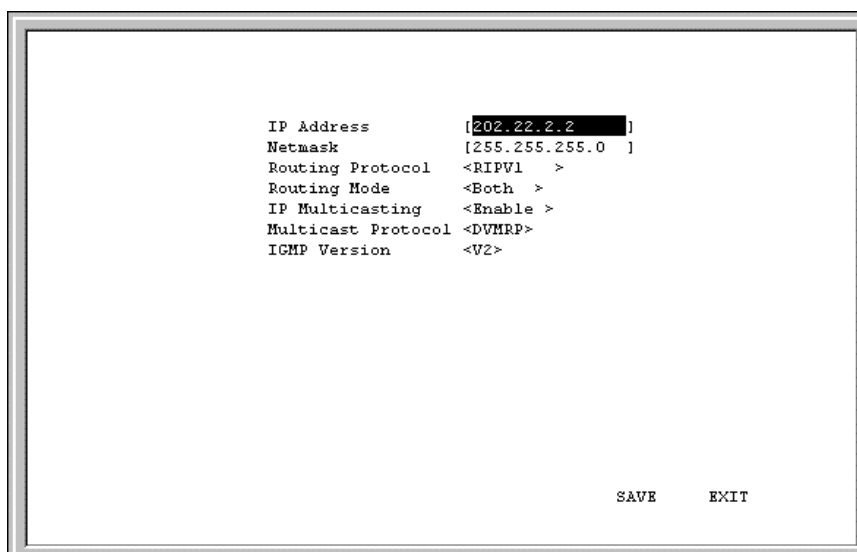

The parameters are described below:

- **IP Address** – This is a network IP address of a separate IP network on the LAN.
- **Routing Protocol** – This is the same as in the **Network Configuration** screen section. Keep in mind that these exchanges are made with adjacent routers on the LAN, if present.
- **IP Multicasting** – This enables/disables IP multicasting on the IP network you are defining.

All other parameters (Netmask, Routing Mode, Multicast Protocol and IGMP Version) are identical to those in the **Network Configuration, IP Stack Configuration, ISDN** screen section.

Static ARP

This special function is intended to speed up the process of finding a host's Ethernet (MAC) address from its network address, and provides a special condition – any other host acting as an impostor by using the same IP address as the legitimate host, will be ignored by this router.

Basically, when a packet comes into the router from the ISDN line and is destined for a host on the LAN, the router will use information defined here to immediately send the packet to the host rather than send out an ARP request to find the host's MAC address.

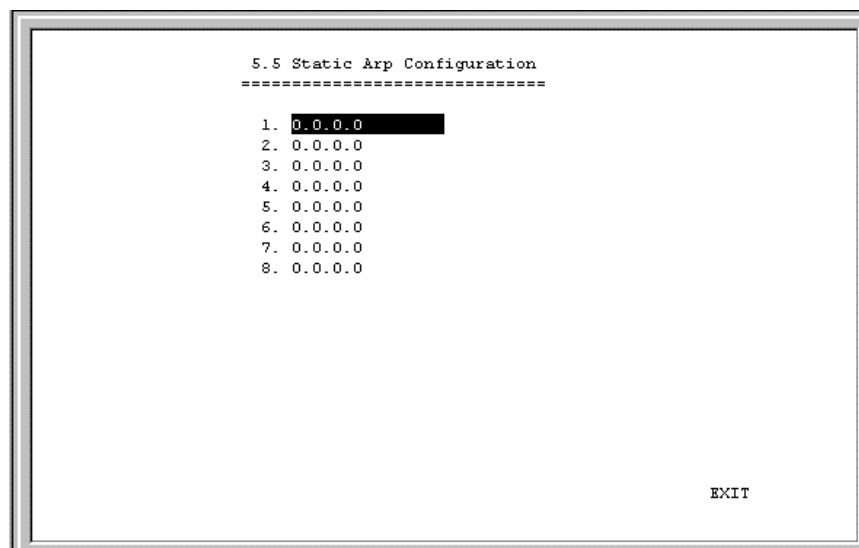

Select an entry above and then press <Enter>. The following screen appears:

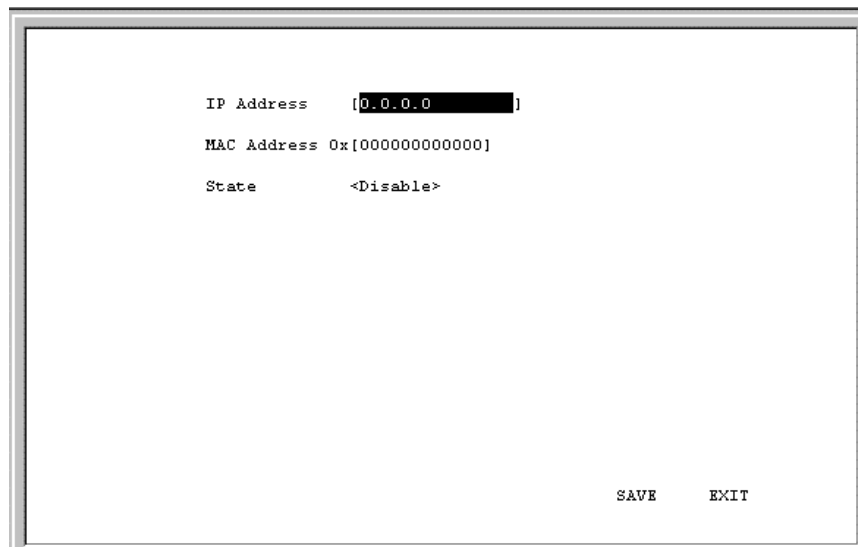

The parameters are described as follows:

- **IP Address** – This is the IP address of the host you wish to define a static ARP for.
- **MAC Address** – This is the physical address of the host that is the authorized owner of the IP address.
- **State** – This toggles enable and disable.

NAT Configuration

Network Address Translation (NAT) is a routing protocol that allows your network to become a *private* network that is isolated from, yet connected to the Internet. It does this by changing the IP address of packets from a *global* IP address usable on the Internet to a *local* IP address usable on your private network (but not on the Internet) and vice versa.

NAT has two major benefits. First, NAT allows many users to access the Internet using a small number or even a single global IP address. This can greatly reduce the costs associated with Internet access and also helps alleviate the current shortage of Internet IP addresses. Secondly, the NAT process creates a firewall which hides your local network from Internet users, providing a degree of security to your Internet connection.

To be successfully implemented, NAT should be used only when the majority of network traffic remains on the local network. In cases where a large percentage of network traffic is destined for the Internet, NAT can adversely affect the speed and performance of your Internet connection. Also, your network servers such as ftp servers, web servers or mail servers will probably need to be assigned *static* NAT IP addresses so their IP addresses remain consistent. This issue will be further discussed later.

Network Address Port Translation (NAPT) is a subset of NAT where many local IP addresses and their TCP/UDP port numbers are translated to a single global IP address and its TCP/UDP port number. In this document, the term NAT will refer to both NAT and NAPT unless otherwise stated.

NAT can work in conjunction with DHCP. Thus, if both are enabled and properly configured, the DHCP server in the DI-206 will assign local IP addresses to computers on your network.

How NAT Works

In the most common NAT configuration, your network uses local IP addresses that are not valid on the Internet. Internet (global) IP addresses are unique, with no two devices have the same IP address. The local IP addresses can be freely assigned to computers on your network by your network administrator (within guidelines defined later in this chapter and in Appendix B, “*IP Concepts*”). This can be done manually or by using DHCP. The ISDN port on the router is assigned a globally unique IP Address that is valid on the Internet, since it will be sending and receiving data directly to the Internet and is therefore part of it. Please study the example diagram below carefully.

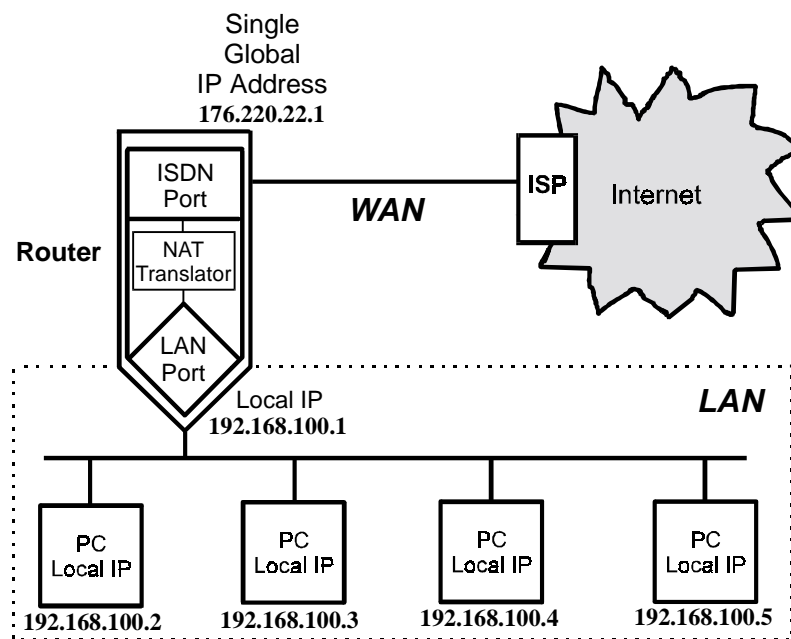

Please note that in the above diagram, the Gateway IP address settings for the local PC's needs to be set to 192.168.100.1, the LAN IP address of the router.

NAT manipulates the IP addresses in packet headers on a one-to-one basis. An outgoing data packet (a packet originating from a computer on the local LAN and destined for a computer outside the private network) will have its IP address translated as shown below.

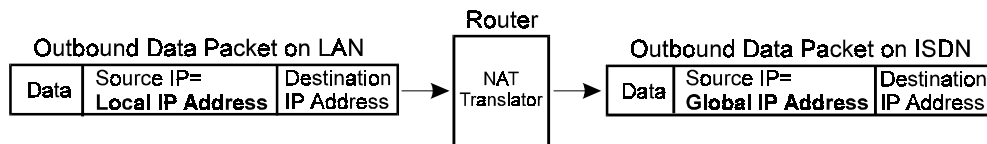

In the Outgoing Data Packet above, the *Source IP address* is the IP address that is translated by NAT. The *Destination IP Address* is the IP address of a computer outside the private network, on the Internet for example. And the *Data* portion of the packet is the information payload borne by the packet, for instance a request to view a web page.

The router logs the changes made to the IP header in its NAT table. The NAT table enables the router to send replies back to the local computer as shown below.

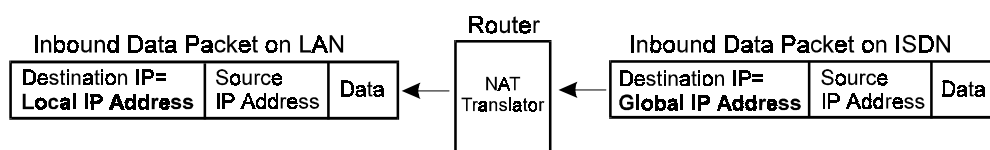

In the Inbound Data Packet above, the *Destination IP Address* is the IP address that is translated by NAT. The *Source IP Address* is the IP address of a computer outside the private network. And the *Data* portion of the packet is the information payload borne by the packet, for example, the contents of a web page.

The actual information in the NAT table depends whether the router is implementing NAT or NAPT.

NAT

This section discusses the NAT protocol as opposed to NAPT, which is discussed in the next section.

NAT is the initial protocol set forth by RFC 1631 and provides a means in which private networks can communicate with the Internet by using a small number of IP addresses. In our discussion, we will use the example IP addresses listed in the table below and the network diagram shown on page 51.

Global IP Addresses (for use with NAT)	Local IP Addresses (assigned to computers on the local network)
200.100.50.1	192.168.100.2
200.100.50.2	192.168.100.3
200.100.50.3	192.168.100.4
200.100.50.4	192.168.100.5
200.100.50.5	192.168.100.6
	192.168.100.7
	192.168.100.8
	192.168.100.9
	192.168.100.10

Please note that in the above table there are 9 users on the local network using 5 global IP addresses to access the Internet.

When a packet on the local network arrives at the router and needs to be sent to the Internet, NAT will change the source IP address (for example 192.168.100.2) to a global address (200.100.50.1, for example). If this packet generates a reply (as for example, a request to view a web page will), NAT will change the destination IP address on the reply packet back to the local IP address for delivery to the machine on the local (stub) network.

The difference between static and dynamic NAT is that once the five global addresses are manually assigned when using static NAT, they will never change. The only way to change them is by using the console program to manually reassign them. When using dynamic NAT, the router will map a local IP address to a global IP address whenever a request is made. Since there are only 5 global IP addresses in the example above, there can only be 5 mappings at any one time. In other words, much like static NAT, only 5 local machines can access the Internet at any one time. However, contrary to static NAT, the router will discard the mapping between the global and local IP addresses after a certain length of time (which is quite long so rarely happens), or after the session is finished (an example of a session is when requesting a web page, the entire page has completed downloading). The most common implementation of NAT is to define a range of dynamic addresses to be used by hosts, but assign static addresses to your servers if you wish for them to be accessible from outside your network.

Setting Local IP Addresses

When implementing NAT and thus creating a private network that is isolated from the Internet, you can assign any IP addresses to host computers without problems. However, the Internet Assigned Numbers Authority (IANA) has reserved the following three blocks of IP Addresses specifically for private networks:

Class	Beginning Address	Ending Address
A	10.0.0.0	10.255.255.255
B	172.16.0.0	172.31.255.255
C	192.168.0.0	192.168.255.255

It is recommended that you choose local IP addresses for use with NAT from the private network IP addresses in the above list. For more information on address assignment, refer to RFC 1597, *Address Allocation for Private Internets* and RFC 1466, *Guidelines for Management of IP Address Space*.

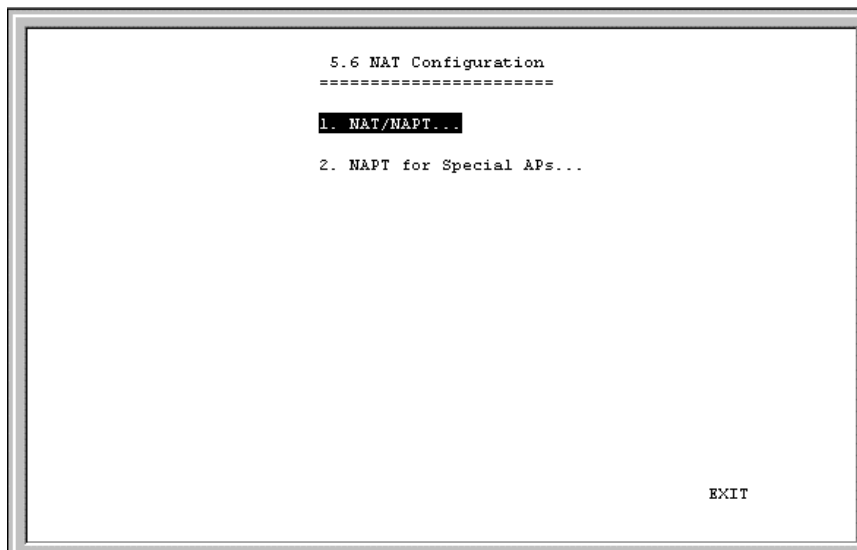

Configure NAT/NAPT

The first screen shows the complete NAT table that is defined by the network manager:

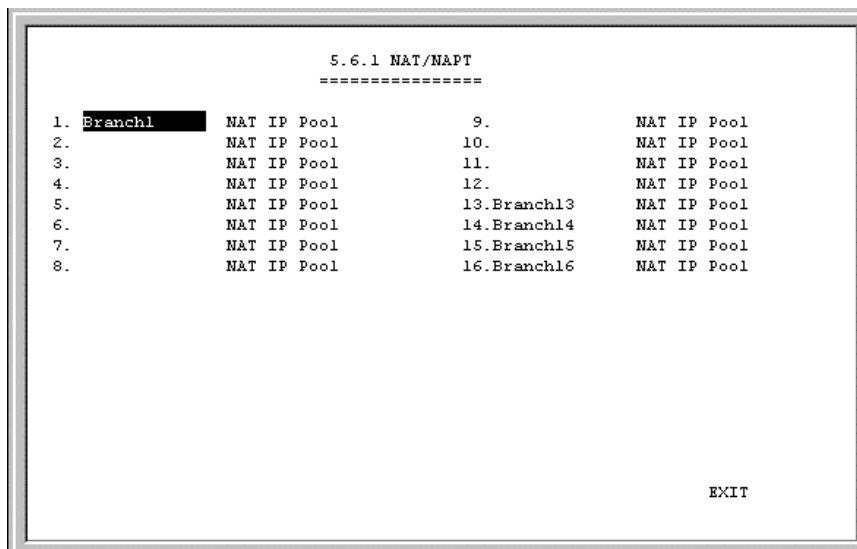

For any NAT entry, you must configure two different screens. The first one is accessible by positioning the cursor over the name field and hitting <Enter> (in the window shown above, this corresponds to the field 'Branch1'). After configuring the NAT options in the Name field, you must save the changes, EXIT, and position the cursor over the NAT IP Pool to configure variables there.

Name Field Configuration Screen

The configuration screen for the name field appears as follows:

```

Name [Branch1 ]
Global Interface <ISDN L1>
Local Interface <LAN >
Translation Mode <Static NAPT >
State <Enable >

SAVE EXIT

```

The parameters are described as follows:

- **Name** – This is a 12 character, alphanumeric, user-defined name, used to identify the network address translation.
- **Global Interface** – This is the interface corresponding to the Global IP and Range parameters, in the NAT table, to form unique IP address[es], known to the outside (regional or Internet) routers, on this interface.
- **Local Interface** – This is the interface corresponding to the Local IP and Range parameters, in the NAT table, to form local IP address[es], known only to this interface and the network within.
- **Translation Mode** – This offers four types of NATs.

Static NAT – Maps one global IP address to one local IP address. After all global IP addresses are assigned, they will remain static. This option may be necessary for email, web, ftp servers, etc. where static IP addresses are essential for operation.

Dynamic NAT – Maps one global IP address to one local IP address. Global IP addresses will be dynamically reassigned to different local IP addresses if not currently being used. This allows a larger number of users to use a small number of IP addresses.

Static NAPT – One to one mapping of UDP/TCP port numbers to let packets with specific UDP/TCP port numbers enter the local IP domain. The NAPT map table will not age. This option may be necessary for email, web, ftp servers, etc. where static port numbers are essential for operation. Setting the global port number to 0 opens port numbers 1024 to 65535 for the designated local IP address, creating a *visible computer*. This allows a computer to be freely accessed by other computers on the Internet, which is necessary for some applications to function correctly when using NAPT, including Microsoft NetMeeting, CUSeeMe, etc.

Dynamic NAPT - One to one mapping of UDP/TCP port numbers. The NAPT map table will age. This option allows many hosts to use a single, globally unique IP address, and thus will only be used on outbound packets.

- **State** – Enables or disables this NAT configuration.

NAT IP Pool Configuration Screen

Now you must select, enter, and configure the NAT IP Pool from the **NAT Configuration** sub-menu, shown below.

Dynamic NAT

This screen (below) is how the NAT IP Pool appears, if Dynamic NAT was chosen for the Translation Mode parameter. Each entry, in this configuration, can be used to map multiple, contiguous global addresses and local addresses to each other.

Dynamic NAT					
=====					
	Global IP	Range	Local IP	Range	State

1.	[13.0.0.0]	1 10 1	[0.0.0.0]	1 10 1	1<Disable>
2.	[20.20.20.1]	1 10 1	[0.0.0.0]	1 10 1	1<Disable>
3.	[20.20.20.1]	1 10 1	[0.0.0.0]	1 10 1	1<Disable>
4.	[20.20.20.1]	1 10 1	[0.0.0.0]	1 10 1	1<Disable>
5.	[20.20.20.1]	1 10 1	[0.0.0.0]	1 10 1	1<Disable>

SAVE EXIT

The parameters are described below:

- **Global IP** – An IP Address that is globally unique and valid on the Internet. It is the base, global address for the global addresses that will be recognized by the interface in the Global Interface parameter.
- **Range** – This is the range of contiguous, global addresses above (and including) the base Global IP.
- **Local IP** – An IP Address that is only used in the stub domain since it is not unique. It is the base, local address for the local addresses that will be recognized by the interface in the Local Interface parameter.
- **Range** – This is the range of contiguous local addresses above (and including) the base Local IP.
- **State** – This toggles enable/disable for this NAT entry.

Dynamic NAPT

This screen (below) is how the NAT IP Pool appears, if Dynamic NAPT was chosen for the Translation Mode parameter. Each entry, in this configuration, can be used to map a single global address and multiple, contiguous local addresses to each other.

```

Dynamic NAPT
=====
Global IP      Local IP      Range      State
-----
1. 210.11.22.3 [15.0.0.0] [0 ] <Disable>
2. 210.11.22.3 [0.0.0.0] [0 ] <Disable>
3. 210.11.22.3 [0.0.0.0] [0 ] <Disable>
4. 210.11.22.3 [0.0.0.0] [0 ] <Disable>
5. 210.11.22.3 [0.0.0.0] [0 ] <Disable>

SAVE      EXIT

```

All of the parameters are the same as in Dynamic NAT, except the Global IP is a solitary, global address.

- **Global IP** – This is a single, globally unique IP Address of the global interface (the interface to which it is assigned, in this case, one of the ISDN interfaces) that is valid on the Internet.

Static NAT

This screen (below) is how the NAT IP Pool appears, if Static NAT was chosen for the Translation Mode parameter. Each entry in this configuration is used to map a single global IP address a single local IP address.

```

Static NAT
=====
Global IP      Local IP      State
-----
1. [14.0.0.0] [0.0.0.0] <Disable>
2. [0.0.0.0] [0.0.0.0] <Disable>
3. [20.20.20.1] [0.0.0.0] <Disable>
4. [20.20.20.1] [0.0.0.0] <Disable>
5. [20.20.20.1] [0.0.0.0] <Disable>

SAVE      EXIT

```

The parameters are described as follows:

- **Global IP** – This is a single, global IP Address that is valid on the Internet, or on the same subnet of the global interface.
- **Local IP** – This is a single, local IP Address that is not valid on the Internet.
- **State** – Enables or disables this entry.

Static NATP

This screen (below) is how the NAT IP Pool appears, if Static NATP was chosen for the Translation Mode parameter. Each entry in this configuration can be used to map a global address and port to a local address and port. Notice that the global address will be the external IP address of the global interface.

Static NATP					
=====					
	Global IP	Port	Local IP	Port	State
	-----	-----	-----	-----	-----
1.	210.11.22.3	[21]	[1.1.1.5]	[21]	<Enable >
2.	210.11.22.3	[0]	[0.0.0.0]	[0]	<Disable>
3.	210.11.22.3	[0]	[0.0.0.0]	[0]	<Disable>
4.	210.11.22.3	[0]	[0.0.0.0]	[0]	<Disable>
5.	210.11.22.3	[0]	[0.0.0.0]	[0]	<Disable>

SAVE EXIT

The parameter not explained in the previous sections is described as follows:

- **Port** – This is a destination port number used by TCP and UDP to de-multiplex incoming IP packets.

In the above example, incoming packets with the global destination IP Address (211.11.22.3) and global destination TCP/UDP port (21) will be translated to a packet with the local destination IP Address (1.1.1.5) and local TCP/UDP port (21).

Port 21 is assigned to FTP servers. Please see Appendix D for more commonly assigned port numbers, or RFC 1700 for a more complete list.

Configure NATP for Special Aps

Some applications programs that are used over the Internet such as Microsoft NetMeeting, Diablo, CU See Me and Xwindows send information to a certain port number or within a specified range of port numbers. The exact port number used is specific to the application. However, if you find that you are having trouble using an

application over the Internet and you are using NAPT, you may need to exempt certain port numbers from the NAPT port translation process. Please refer to the user guide for the program to find out whether it transmits and receives data only through specified IP port numbers. In order for these programs to work with NAPT, the IP port numbers required by these applications must be entered in the Configure NAPT for Special APs screen shown below.

```

5.6.2 NAPT for Special APs
-----
1. Diablo
2.
3.
4.
5.

EXIT

```

In the above window, position the cursor on any of the numbered name fields and press <Enter>. This will take you to the NAPT configuration screen for special applications shown below.

```

Application Name [Diablo]
State <Enable >

Protocol  Start Port  End Port  Connection Type
1. <TCP>   [6112 ]  [6112 ]  <OutgoingControl>
2. <UDP>   [6112 ]  [6112 ]  <IncomingData >
3. <TCP>   [0 ]    [0 ]    <Disable >
4. <TCP>   [0 ]    [0 ]    <Disable >
5. <TCP>   [0 ]    [0 ]    <Disable >
6. <TCP>   [0 ]    [0 ]    <Disable >
7. <TCP>   [0 ]    [0 ]    <Disable >
8. <TCP>   [0 ]    [0 ]    <Disable >

SAVE      EXIT

```

The fields in the above window are described as follows:

- **Protocol** – *UDP* or *TCP*. This field designates the type of packets that will be acted on.
- **Start Port** – Some applications can only send data over a certain range of port numbers. Thus, all port numbers in the specified range must be exempt from the

NAPT port translation process. This field defines the beginning range of the port numbers to be exempted from the NAPT port translation process.

- **End Port** – This field defines the last port number in the range of numbers excluded from the NAPT process (see Start Port above).
- **Connection Type** – *Outgoing Control* or *Incoming Data*. The user must initially run the special application and send a request to the application server on the Internet. This outgoing request to join a Diablo server, for example, is used to trigger the exemption process for the incoming data.

In the example for the game Diablo shown in the above screen, if a packet is sent out on the TCP port number 6112 (a request by a local user to a Diablo server on the Internet to join a group game), all incoming packets on the UDP port 6112 (game data) will not be translated by NAPT.

Please keep in mind that the user will always initiate use of the special application. Thus, the first entry should always have the Connection Type of *Outgoing Control*. Also, since the defined port number or range of port numbers will be mapped to the user who triggered the outgoing control, all incoming data will be sent to that user. Consequently, only one user can use the special application at a time.

Telnet/Discovery Enable

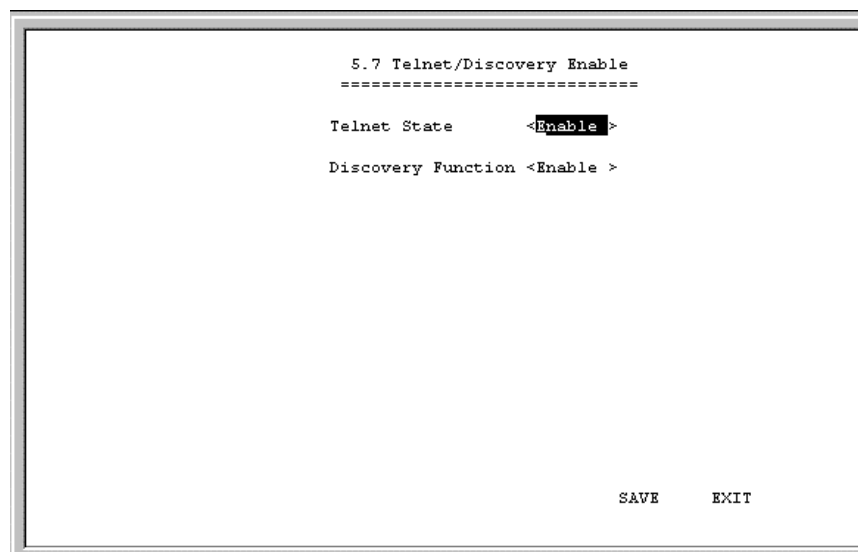

The fields in the above window are described as follows:

- **Telnet State** - This feature enables or disables the router's ability to be configured over the LAN using telnet.
- **Discovery Function** – Enabling this feature allows the router to be auto-discovered by D-Link SNMP management software and the included Windows-based configuration software called *RouteMan*.

DNS Configuration

The DI-206 router has a built in recursive DNS server. The maximum amount of memory that will be used by the router's Domain Name Server is 64Kb which averages out to be about 800 entries. In other words, up to 800 domain names and their associated IP Addresses can be stored, which can significantly speed up access to those domains. The routers DNS table will age out about every 24 hours, ensuring that the most frequently accessed domains consistently benefit from the improved access times provided by using the routers own DNS.

The IP Addresses for domain names not stored in the router must be acquired from a DNS server on the Internet. Thus, if you are using DNS, make sure you also specify an IP Address to a DNS server in the Forward DNS queries to field.

```

                    5.8 DNS Configuration
                    =====
DNS Server State      <Enable >
Lookup Host Table    <Enable >
DNS Domain Name      [dlink.com          ]
Forward DNS queries to [144.13.12.1    ]
DNS Cache State      <Enable >
Host Table...

                                [SAVE]  [EXIT]

```

The items in the above submenu are described as follows:

- **DNS Server State** – Enables or disables recursive DNS on this router.
- **Lookup Host Table** – Enables or disables DNS to reference up to eight host names defined in the Host Table shown below.
- **DNS Domain Name** – The domain name suffix in which the router resides, to be appended to the host name defined in the host table.
- **Forward DNS queries to** – A large server dedicated to resolving domain names on the Internet. This field should contain the IP Address for the DNS closest to you.
- **DNS Cache State** – When this item is enabled, the router will add the domain names and IP Addresses it retrieves from DNS replies to it's DNS cache.

Host Table

The host table allows the router to recognize host names on the network. Up to eight host names can be entered in the table. Your network servers, especially your mail server should be defined here. Leftover places in the table can be assigned to individual hosts to speed up routing.

In the example below, the host name “ctsnow” is combined with the domain name defined in the **DNS Configuration** submenu above (in this case, “dlink.com”) to produce “ctsnow.dlink.com”. The mapping in the example of “ctsnow.dlink.com” to the IP Address of 11.1.1.3 is only valid for computers which set the DI-206 router as their DNS server.

```

                    5.8 DNS Configuration - Host Table
                    =====

```

IP	Host Name	State
1. [11.1.1.3] [ctsnow] <Enable >
2. [0.0.0.0] [] <Disable>
3. [0.0.0.0] [] <Disable>
4. [0.0.0.0] [] <Disable>
5. [0.0.0.0] [] <Disable>
6. [0.0.0.0] [] <Disable>
7. [0.0.0.0] [] <Disable>
8. [0.0.0.0] [] <Disable>

SAVE EXIT

Items are described as follows:

- **IP** – The IP address for the host.
- **Host Name** – The host name used by the host.
- **State** – Enables or disables entry.

Radius Configuration

Radius is an authentication protocol where passwords are stored on a Radius server. Radius allows large numbers of passwords to be stored in a centralized location. Before instituting Radius, please setup and install a Radius server on the LAN.

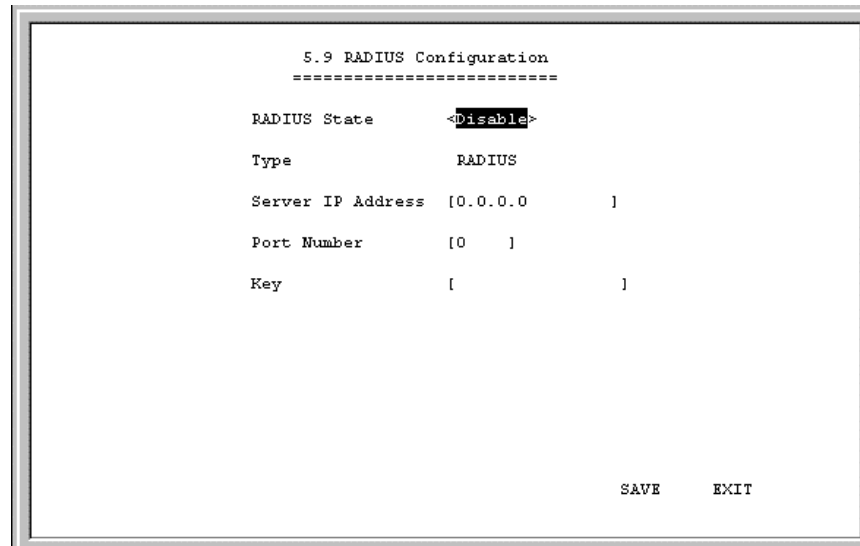

Items in the above submenu are described as follows:

- **RADIUS State** – Enables or disables Radius. When enabled, all settings in the Dial-in User Profile are disabled.
- **Type** – Refers to the type of external password protocol. Currently, only Radius is supported.
- **Server IP Address** – This is the IP Address of your UNIX or NT-based Radius server.
- **Port** – The port number for the Radius server. The standard port number specified by RFC 1700 is 1812 (shown above).
- **Key** – This is a shared secret used to identify the router as a valid Radius client.

The Radius authentication service works for dial-in users only. Thus, when Radius is enabled, passwords for dial-in users will no longer be checked in the *dial-in user profile*. Instead, the authentication request will be passed on to the Radius server. Remote networks (routers) dialing into the router will still be authenticated using the *remote network profile*.

Multi-Link PPP Configuration

Multi-link PPP (MLPPP) is a standard (RFC 1990 and RFC 1717) for inverse multiplexing, a method of combining individually dialed channels into a single, higher speed data stream. MLPPP is an extension of PPP that supports the ordering

of data packets across multiple channels. Although MLPPP can be implemented on any WAN device, it was the rapid emergence of ISDN BRI as a cost efficient higher bandwidth alternative to modems which has driven the evolution and acceptance of MLPPP. Typically MLPPP is used to combine the speed of two ISDN BRI B-Channels to get 128Kbps of virtual capacity.

Before implementing MLPPP on the DI-206, please ensure that your ISP or the device to which you are connecting supports, and is configured for MLPPP.

MLPPP can be implemented in two ways, dynamically through the use of the Bandwidth on Demand (BOD), and statically. BOD causes the second ISDN port to place a call and add bandwidth to the ISDN connection when the BOD High Threshold is exceeded for the Add Bandwidth Delay period. Bandwidth can also be subtracted when ISDN throughput falls below the BOD Low Threshold and Subtract Bandwidth Delay parameters. Thus, BOD economizes MLPPP by maintaining only the bandwidth needed.

A static implementation of MLPPP is achieved when BOD is disabled but the ISDN ports have Multi-Link enabled. In this case, when the two ISDN ports have established a connection, the router will check to see if they are connected to the same source and whether the source supports MLPPP. If both conditions are met, the router will automatically bundle the two links together as an MLPPP connection.

Choosing *Multi-Link PPP Configuration* displays the following screen:

```
5.10 Multi-Link PPP Configuration
=====

Bandwidth On Demand      <Enable>
BOD Criteria             <TX or RX>
BOD High Threshold (%)   [70 ]
BOD Low Threshold (%)    [30 ]
Add Bandwidth Delay (sec) [5 ]
Subtract Bandwidth Delay (sec) [10 ]

                               SAVE   EXIT
```

Items in the **Multi-Link PPP Configuration** window are described as follows:

- **Bandwidth on Demand** – Enables or disables BOD. When enabled, BOD will manage the implementation of MLPPP using the parameters defined in this window.
- **BOD Criteria** – Either *TX*, *RX* or *TX+RX*, where *TX* is Transmit and *RX* is Receive. The parameter defined here is used when monitoring the BOD High Threshold and BOD Low Threshold.

- **BOD High Threshold (%)** – (0 to 100) The throughput value as a percentage of total bandwidth which will cause the next ISDN port having Multi-Link PPP enabled to dial up and add bandwidth to the connection. This value, however, must be constantly exceeded for the time designated in the Add Bandwidth Delay field before the next ISDN port dials out.
- **BOD Low Threshold (%)** – (0 to 100) The throughput value as a percentage of total bandwidth which will cause the highest numbered ISDN port in the MLPPP bundle to hang up, thus subtracting bandwidth from the connection. Before actually hanging up however, the throughput must be below this value for the time designated in the Subtract Bandwidth Delay field.
- **Add Bandwidth Delay (sec)** – (0 to 300) The amount of time in seconds the router will wait and sample the BOD Criteria before adding bandwidth once the throughput exceeds the BOD High Threshold. This prevents costly bandwidth from being unnecessarily added due to temporary bursts in traffic.
- **Subtract Bandwidth Delay (sec)** – (0 to 300) The amount of time in seconds the router will wait and sample the BOD Criteria before subtracting bandwidth once the throughput falls below the BOD Low Threshold. This prevents bandwidth from being unnecessarily subtracted due to temporary lulls in traffic.

The example Multi-link PPP settings shown in the **Multi-Link PPP Configuration** window above assumes that ISDN 1 and ISDN 2 each have a 64kbps connection configured to dial up to the Internet. When ISDN 1 receives a packet destined for the Internet it will dial the ISP and establish a connection. If the total throughput on ISDN 1 (*TX + RX*) ever exceeds 80% of the 64kps (51.2kps), the router will sample the line for an additional 5 seconds. If the traffic continuously exceeds 80% for the 5 second delay time, ISDN 2 will dial up and add bandwidth to the connection. Assuming sustained traffic of 70kps, MLPPP will balance the traffic on the two ISDN ports so they are handling roughly 35kps each. If the traffic on ISDN 1 + ISDN 2 falls below 20% of the 128kps connection (25.6kps) for more than 10 seconds, ISDN 2 will hang up and all traffic will be handled by ISDN 1.

For the above configuration to work, both ISDN ports need to have been properly setup to establish dial-out PPP connections, and have Multi-Link enabled. Also note that ISDN 1, being the B-channel that initiated the call in the MLPPP bundle and thus the primary link, is not subject to the BOD Low Threshold parameter and will never hang up due to BOD considerations. The primary link can, however, be subject to Dial on Demand (DOD) settings, and could thus disconnect if Dial on Demand is enabled and the Idle Time parameter is met. Dial on Demand settings are located in the **Advanced Functions, Dial Configuration** submenu.

Admin Configuration

This feature allows you to define two names and two passwords, respectively, for logging in to the router for configuration and management, and is shown below:

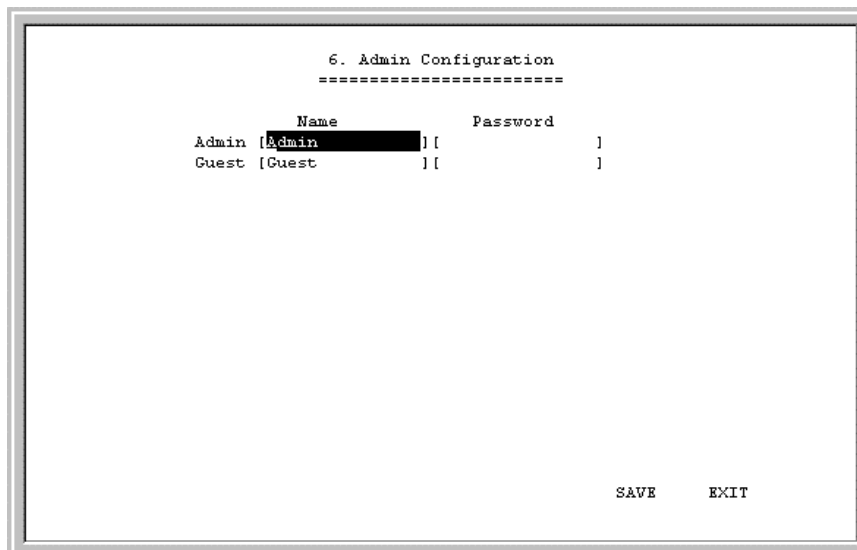

Please note any changes made here as they are necessary for logging into the console program.

System Maintenance

Your console program includes many useful tools for maintaining your device. These tools include updates on system status, upgrades to the system software, analysis, diagnostic tools and more. This section will describe how to use these tools in greater detail.

The **System Maintenance** sub-menu appears as follows:

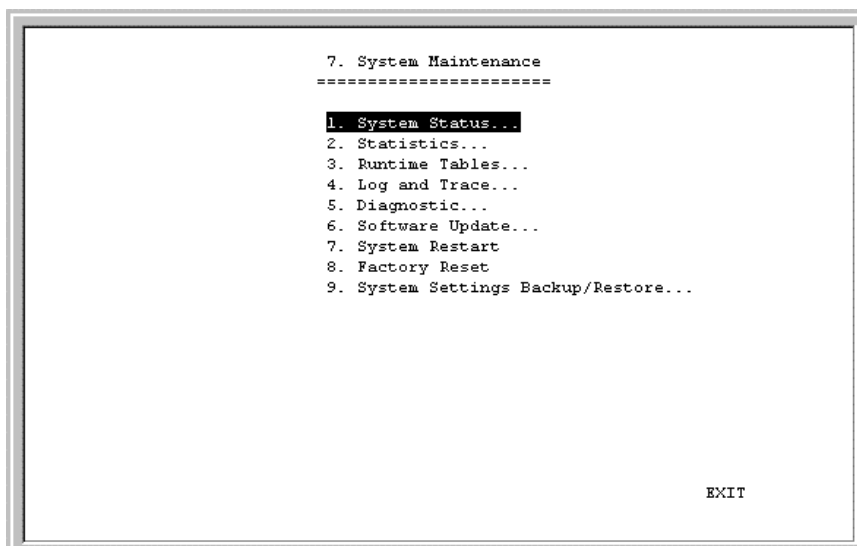

System Status

The **System Status** submenu displays key information about the router and appears as follows:

```

                          7.1 System Status
                          =====
Port      Protocol Link  Speed  Tx Pkt   Rx Pkt   Err Pkt  Up time
-----
LAN       LLC      Up    10HD    3700     51061    0        1:25:35
ISDN B1 Switch Down 64000  0        0        0        0
ISDN B2 Switch Down 64000  0        0        0        0

                          System Information :
Model Name DI-206           Firmware Version 1.81
Build Time May 26 22:02:23 2000   Config Version 0.1
ISDN Version 1.06
ISDN B1 CLID
ISDN B2 CLID

                          EXIT

```

Statistics

Under the **Statistics** submenu, counter tables are displayed for LAN, ISDN B1, and ISDN B2:

```

                          7.2 Counter
                          =====
                          LAN...
                          ISDN B1...
                          ISDN B2...

                          EXIT

```

Counter

This feature displays some of the counters contained in MIBII and the proprietary MIB. The table is updated every 5 seconds, and the counter table can be reset by performing a system reset on the router. Note that performing a system reset clears ALL tables in the router, including the routing table.

LAN Counter Table

LAN			
=====			
Tx Packets	3872	Rx Packets	52106
Tx Bytes	291661	Rx Bytes	4979372
Tx Discard Packets	0	Rx Unknown Packets	140081
Tx Error Packets	0	Rx Discard Packets	0
Tx Collision Packets	0	Rx Error Packets	0
Tx Abort Packets	0	Rx CRC Packets	0
Tx Underrun Packets	0	Rx FAE Packets	0
		Rx Overrun Packets	0
		Rx MPA Packets	0
		Rx DFR Packets	0

EXIT

- **Tx Packets** – The total number of valid packets transmitted by the router since the last reset.
- **Tx Bytes** – The total number of bytes transmitted by the router.
- **Tx Discard Packets** – The number of packets dropped by the router.
- **Tx Error Packets** – The number of invalid packets transmitted by the router. This hardware counter shows the sum of Collisions, Abort and Underrun packets.
- **Tx Collision Packets** – The number of packets sent out of the router that collided on the line. Some collisions are inevitable due to the shared nature of Ethernet. Excessive collisions show excessive utilization of the network.
- **Tx Abort Packets** – When the router transmits a packet and a collision occurs, the router will wait a random period and try to retransmit the packet. If a collision occurs 16 times in a row, the transmission will be aborted and be logged by this counter. An aborted packet shows extremely heavy utilization of the network.
- **Tx Underrun Packets** – Runt packets. The number of packets transmitted by the router that are less than the allowed 64 octets minimum length. Underrun packets occur due to jam signals generated by collisions, backpressure, etc.
- **Rx Packets** – The number of valid packets received by the router.
- **Rx Bytes** – The total number of bytes contained in the valid packets received by the router.
- **Rx Unknown Packets** – The number of packets received by the router that were of an unsupported protocol.
- **Rx Discard Packets** – The number of packets dropped by the router.
- **Rx Error Packets** – The number of invalid packets received by the router. This hardware counter shows the sum of CRC, FAE, Overrun, MPA and DFR error packets.
- **Rx CRC Packets** – The number of packets received that failed the CRC checksum test.

- **Rx FAE Packets** – Frame Alignment Error. The number of packets received that does not end on a byte boundary and the CRC does not match.
- **Rx Overrun Packets** – The number of packets received that exceed the 1518 octet maximum length imposed on Ethernet packets. Overrun packets are generated by some proprietary software applications.
- **Rx MPA Packets** – Missed Packet. This is a count of packets intended for the router, but at the time, the router could not receive the packet (usually due to the temporary lack of receive buffers).
- **Rx DFR Packets** – Deferred Packets. This is a count of incidents where CRS (carrier signal lost) and COL both occur at the same time. These two events happen simultaneously as a result of jabber (produced by faulty networking equipment, usually NIC's).

ISDN Counter Table

ISDN B1 =====			
Tx Packets	0	Rx Packets	0
Tx Bytes	0	Rx Bytes	0
Tx Discard Packets	0	Rx Unknown Packets	0
Tx Error Packets	0	Rx Discard Packets	0
Tx Underrun Packets	0	Rx Error Packets	0
Tx Lost CTS Packets	0	Rx NOA Packets	0
		Rx Abort Packets	0
		Rx CRC Packets	0
		Rx Overrun Packets	0
		Rx CD Lost Packets	0
		Rx Framing Err Packets	0
		Rx Parity Err Packets	0

EXIT

- **Tx Packets** – The total number of valid packets transmitted by the router since the last reset.
- **Tx Bytes** – The total number of bytes transmitted by the router.
- **Tx Discard Packets** – The number of packets dropped by the router.
- **Tx Error Packets** – The number of invalid packets transmitted by the router. This hardware counter shows the sum of Collisions, Abort and Underrun packets.
- **Tx Underrun Packets** – Runt packets. This counter shows the number of packets transmitted by the router that are less than the allowed 64 octets minimum length. Underrun packets occur due to jam signals generated by collisions, backpressure, etc.
- **Tx Lost CTS Packets** – The number of Clear To Send packets that were lost by the router.
- **Rx Packets** – The total number of packets received by the router.

- **Rx Bytes** – The total number of bytes contained in packets received by the router.
- **Rx Unknown Packets** – The number of packets received by the router that were of an unsupported protocol.
- **Rx Discard Packets** – The number of packets dropped by the router.
- **Rx Error Packets** – The number of invalid packets received by the router. This hardware counter shows the sum of NOA, Abort, CRC, Overrun, CD Lost, Framing and Parity error packets.
- **Rx NOA Packets** – Non-Octet Alignment. This counts the number of packets received by the router that did not end on a byte boundary. The receipt of a misaligned packet will generate a single NOA event regardless of the number of misaligned octets in the packet.
- **Rx Abort Packet** – The number of packets that were dropped due to user generated breaks in the transmission that occurred while a packet is being received.
- **Rx CRC Packets** – The number of packets received that failed the CRC checksum test.
- **Rx Overrun Packets** – The number of packets received that exceed the 1518 octet maximum length imposed on Ethernet packets. Overrun packets are generated by some proprietary software applications.
- **Rx CD Lost Packets** – Carrier Detect Lost. This counts the number of Carrier Detect packets that were lost by the router.
- **Rx Framing Error Packets** – Packets with framing errors can occur on the ISDN port only when using HDLC in sync mode. This parameter counts the number of lost start/stop flags.
- **Rx Parity Error** – The number of times parity errors occurred on the line.

Runtime Tables

The **Runtime Tables** submenu features *IP Routing Table*, *ARP Table*, and *PPP Table*:

```

7.3 Runtime Tables
=====
IP Routing Table

ARP Table

PPP Table

EXIT

```

IP Routing Table

The IP Routing Table gives you a snapshot of the IP routing table. Table entries will expire after the Age value in the table counts down to zero seconds (except for entries for the router itself which have an age value of zero but will never expire).

```

IP Address      Netmask      Gateway      If      Hops      Age
-----
0.0.0.0         0.0.0.0      172.22.3.1   ISDN L1  1         0
202.12.124.0   255.255.255.0 202.12.129.1 ISDN L2  1         0
202.12.125.0   255.255.255.0 210.172.23.1 LAN       1         0
202.22.2.0     255.255.255.0 202.22.2.2   MIP1     1         0
202.39.74.0    255.255.255.0 202.39.74.95 LAN       1         0

Display      Next      EXIT

```

- **IP Address** – This is the destination, network IP address from an incoming packet.
- **Netmask** – This mask is received from RIP exchanges and internal calculations, as the router learns.
- **Gateway** – This is the next-hop router for which the packet, with destination IP Address and qualifying Netmask, will be forwarded.
- **If** – This is the outgoing interface for which the acceptable, routing packet will be forwarded.
- **Hops** – This is the remaining hop-count.

- **Age** – This is the time-to-live (TTL) value.

ARP Table

The ARP Table maps the IP address with a MAC address.

IP Address	MAC Address
202.22.2.2	0050BA0067C2
202.39.74.1	0000E836B68A
202.39.74.3	0000F4631B5B
202.39.74.4	0080C895A687
202.39.74.5	0050BA0005C6
202.39.74.7	0080C8F615C3
202.39.74.8	0080C8888888
202.39.74.11	000000002000
202.39.74.13	0080C8F713A5
202.39.74.19	0000F4905011
202.39.74.25	0080C8F6D284
202.39.74.26	0080C8680C21
202.39.74.27	004005000029
202.39.74.31	0080C8F64B88
202.39.74.32	0050BA000A98
202.39.74.42	0080C85828D6
202.39.74.66	0000E82C69D3
202.39.74.67	0080C8F6F08D

Display Next EXIT

- **IP Address** – This is the network layer IP address.
- **MAC Address** – This is the data link MAC address.

PPP Table

The PPP Table allows you to display the interface and link status for either ISDN Link 1 or ISDN Link 2 from the **PPP Status** sub-menu.

PPP Status
Interface: ISDN1
Link Down

Display EXIT

- **Interface** – The desired interface.
- **Link Down** –The present link status.

Log and Trace

This feature files events and errors that occurred and allows individual packets to be captured in a buffer. These items are to help D-Link technical support personnel identify problems that may be affecting your router. If problems occur with your router, D-Link technical support personnel will guide you through the use of these features.

```
7.4 Log and Trace
=====
1. Event/Error Log...
2. Trace Buffer...
3. Packet Triggered Last Call...

EXIT
```

Event/Error Log

```
7.4.1 Event/Error Log
=====
1. Log Configuration...
2. View Log File

EXIT
```

Log Configuration

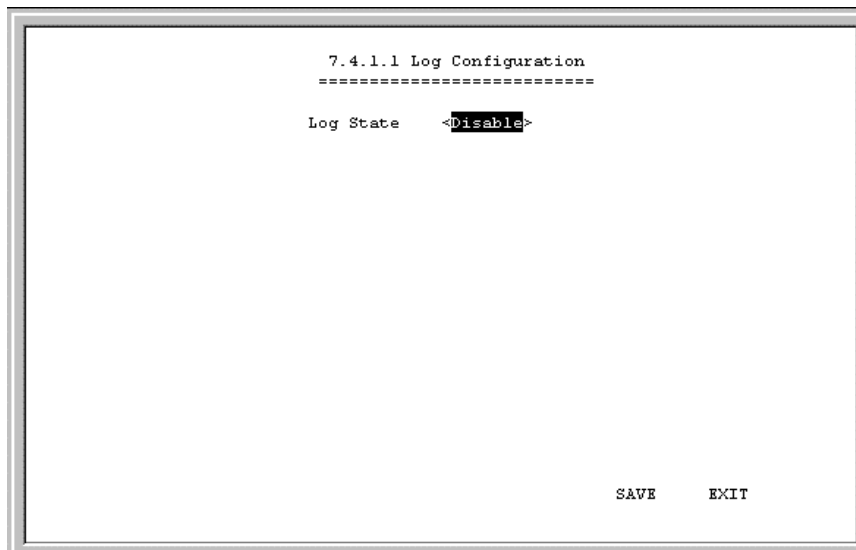

This option allows you to enable or disable the Event/Error log and begin recording events.

View Log File

This displays the Event/Error Log file shown below:

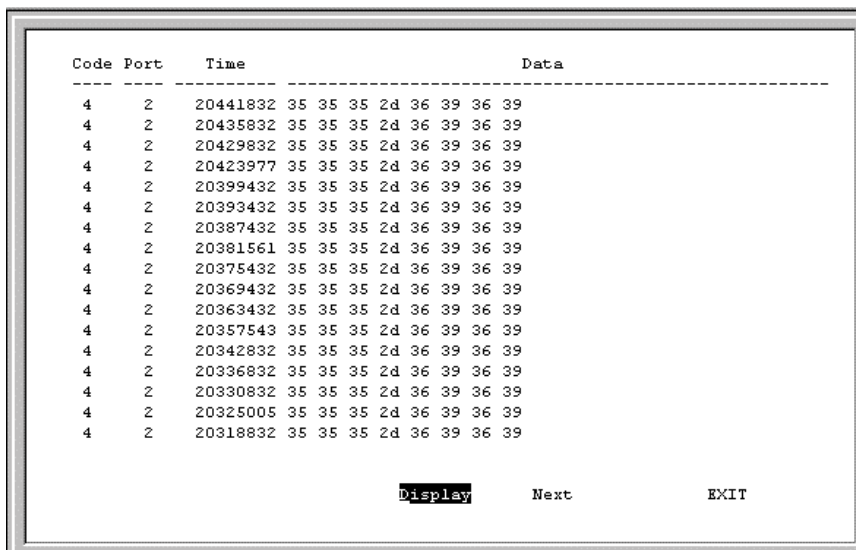

The parameters are described as follows:

- **Code** – A special code for categorizing events. Some codes include:

- 0 Cold Start
- 1 Link Change
- 2 Tx Abort
- 3 Rx Abort
- 4 Connect/Disconnect
- 5 NAT Request
- 6 DHCP Request

- **Port** – The interface on which an event occurs.
- **Time** – Tick-times denoting when events occurred.
- **Data** – Data that helps technical support personnel evaluate the event.

Trace Buffer

This feature captures packets in a buffer to help D-Link technical support personnel identify problems with your router.

```
7.4.2 Trace Buffer
=====
1. Trace Buffer Configuration..
2. View Trace Buffer

EXIT
```

Trace Buffer Configuration

```
7.4.2.1 Trace Buffer Configuration
=====
Interface <LAN >
Direction <In >
State <Enable >

SAVE EXIT
```

The parameters are described as follows:

- **Interface** – Select *LAN*, *ISDN B1*, or *ISDN B2*.

- **Direction** – Select *In*, *Out*, or *Both*.
- **State** – Enables or disables the Trace buffer feature

View Trace Buffer

Displays the header of packets captured in the buffer.

```

Time                Data
-----
12566640 ff ff ff ff ff ff 0 40 5 51 de 26 8 6 0 1 8 0
        6 4 0 1 0 40 5 51 de 26 cb 4a 4d 23 0 0 0 0
        0 0 cb 4a 4d 2e 0 0 0 0 0 0 0 0 0 0 0 0
        0 0 0 0 0 0
12566642 ff ff ff ff ff ff 0 80 c8 64 c9 dc 8 0 45 0 0 eb
        4c 33 0 0 20 11 fd d9 d2 44 55 ad d2 44 55 bf 0 8a
        0 8a 0 d7 dc 38 11 1a 0 49 d2 44 55 ad 0 8a 0 c1
        0 0 20 45 4b 45 46 45 42 45
12566661 ff ff ff ff ff ff 0 80 c8 f6 f0 8d 8 0 45 0 0 4e
        7f 10 0 0 80 11 91 fd ca 27 4a 43 ca 27 4a ff 0 89
        0 89 0 3a bd 5c 8e fe 1 10 0 1 0 0 0 0 0 0
        20 45 4e 46 4a 46 44 45 50 45
12566664 ff ff ff ff ff ff 0 80 c8 aa aa eb 8 6 0 1 8 0
        6 4 0 1 0 80 c8 aa aa eb a 9 44 4f 0 0 0 0
        0 0 a 9 44 20 0 0 0 0 0 0 0 0 0 0 0
        0 0 0 0 0 0

Interface <LAN >      Display      Next      EXIT
    
```

The contents are described as follows:

- **Interface** – This is the interface from which the packets were captured.
- **Time** – In clock ticks. The time the packet was captured.
- **Data** – The contents of the header of the packet.

Packet Triggered Last Call

This feature allows you to see the packet that caused the last call to be made.

```

7.4.3 Packet Triggered Last Call
=====

Packet Type : IP

45 00 00 28 35 97 40 00 7F 06 66 8C CA 27 4A 0B D2 AE
78 CB 0B DA 00 50 01 2C AE 53 3A 23 A0 CE 50 11 1F E0
99 DE 00 00 20 20 20 20 20 20

Display      EXIT
    
```

Diagnostic

This feature tests the connection between the router and connected peripherals on a given interface. Please note that if Telnet is used to access the router, only the Ping Test diagnostic is available from the menu below.

```
7.5 Diagnostic
=====
Connection Test...
IP Ping Test...
Loopback Test...
System LAN
System ISDN

EXIT
```

Connection Test

This feature tests a dial-out ISDN connection.

```
Connection Test
=====
Interface <ISDN L1>
Phone Number [          ]
Connection Test
Dial Out
Hang Up

EXIT
```

The parameters are described as follows:

- **Interface** – The ISDN B-channel to be tested.
- **Phone Number** – The phone number that will be dialed by the ISDN Interface. Please ensure that a modem answers the phone on the other end.

- **Connection Test** – Position the cursor over this item and press <Enter> to begin the test. The router will dial the phone number defined above, try to establish a valid link with the answering ISDN device and hang up. This test can only be performed if the Interface is disabled in the **Interface Configuration, ISDN** submenu.
- **Dial Out** – Press <Enter> to begin the test. The router will dial the phone number above and negotiate a connection with the answering device. In order for this test to work, a Remote Network Profile must be created for the connection.
- **Hang up** – Press <Enter> to hang up after Dialing Out.

Ping Test

This test makes sure there is an IP network connection to a particular IP address.

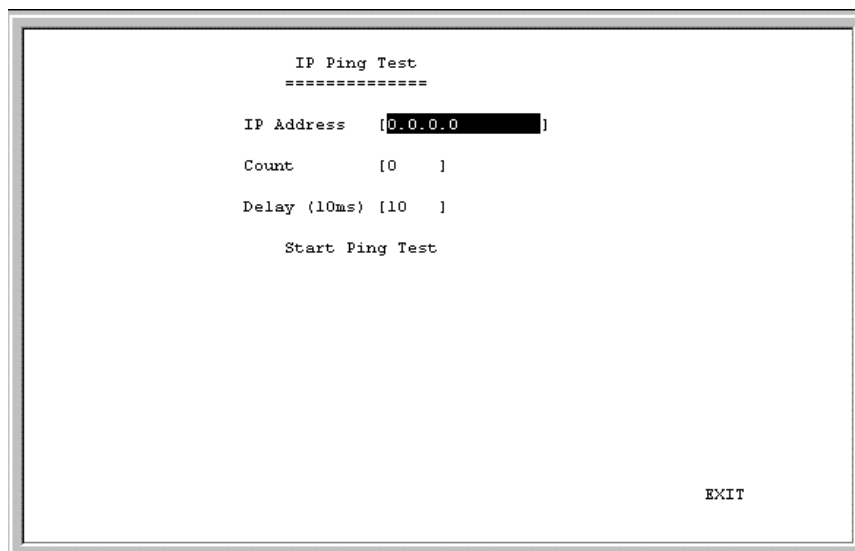

The parameters are described as follows:

- **IP Address** – This is the IP Address of the device that the router will attempt to reach. The router will check its routing table and try to locate the IP Address.
- **Count** – The number of pings (packets) that will be sent. A value of 0 will cause pings to be sent continuously.
- **Delay (10ms)** – The amount of time in 10 millisecond intervals between each ping in the Count.
- **Start Ping Test** - Press <Enter> or <Return> to begin the test.

Loopback Test

The loopback test is used to test the path ISDN network between your phone company's switch and the router.

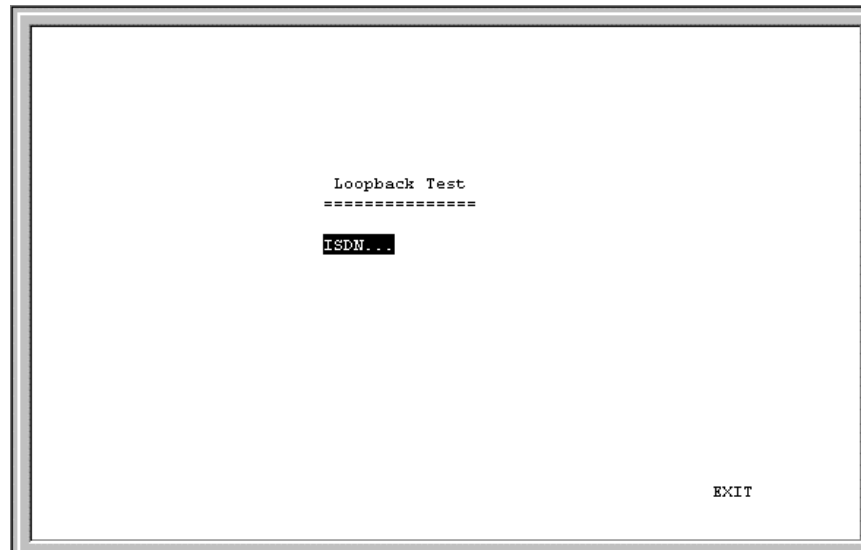

Press <Enter> on the screen above.

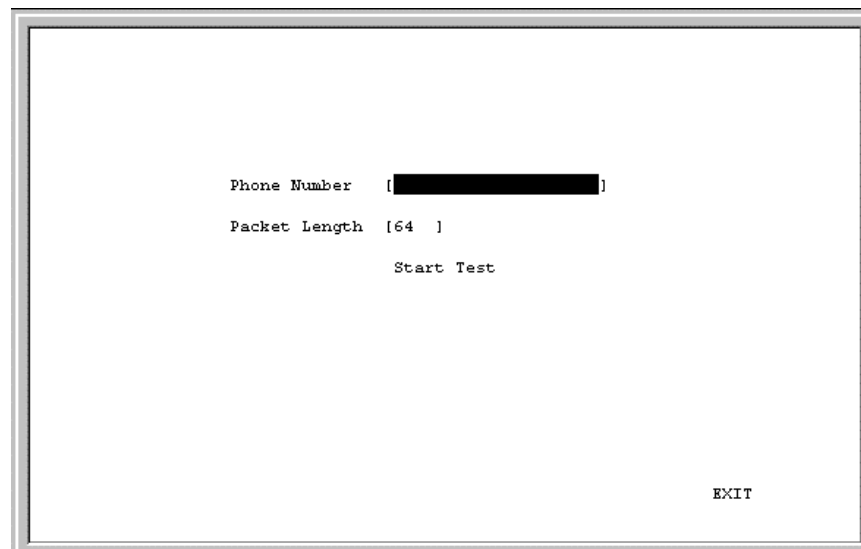

- **Phone Number** – Enter your own phone number here to establish a connection between your ISDN B1 and B2 channels.
- **Packet Length** – [1 to 1500 bytes]. This field allows you to define different sized data packets to test the ISDN line.
- **Start Test** - Press <Enter> or <Return> to begin the test.

System LAN

The System LAN test is used to diagnose the LAN port. It can only be run if the LAN port is disabled in the **Interface Configuration** submenu.

```
LAN Port 1 is enable now; Diagnostic Aborted  
strike any key to continue ...
```

System ISDN

This test diagnoses the ISDN ports. It can only be run if the ISDN port is disabled in the **Interface Configuration** submenu.

```
ISDN Chan 1 is enable now; Diagnostic Aborted  
strike any key to continue ..._
```

Software Update

New routing software can be downloaded from a TFTP server.

If you do not have a TFTP server on your LAN, you can use the included Router Configuration Utility to upgrade the software. This Windows-based utility has a built-in TFTP emulator enabling you to use the computer (connected to the LAN and running the Configuration Utility) to upload the new software to the router.

```
7.6 Software Update Menu
=====

Software Update          <Disable>
Software Update Mode    Network

Boot Protocol            <TFTP ONLY >
Boot Server IP Address   [10.17.53.25 ]
Boot File Name           [c:\amy\di-206\vl.80\206r181.hdr ]
Last Boot Server IP Address: 0.0.0.0

Update Software from Configuration File <No >

                               SAVE   EXIT
```

This is the same Software Update configuration information contained in the *Software Update* section in the “*PROM System Configuration*” chapter. The parameters are described in that section.

Perform a System Restart after configuring these settings begins the software update procedure.

System Restart

The system restart function enables you to reset the DI-206 without powering off. Some setting changes require a system restart in order for them to take effect.

```
7.7 System Restart
=====

Are you sure you want to restart? No Yes
```

A system restart will not affect the router’s settings, but will clear all tables including the routing table and all SNMP counters and tables. It is also used to initiate a software update.

Factory Reset

Performing a factory reset erases all settings and tables. All configuration changes ever made to the router will be deleted. The router will be set to the factory defaults it was shipped with and will no longer have an IP address.

```
7.8 Factory Reset
=====

WARNING! Performing a factory reset will erase all settings!
Are you sure you wish to proceed? No Yes
```

Please make sure you wish to wipe out all settings and configure the router from scratch before you perform a factory reset

System Settings Backup/Restore

The backup and restore system settings functions are used to backup the router settings. The files created by these processes are different than configuration files or software update files that are used in the **Software Update** submenu. The files defined here can be used as a backup for all the router settings and can be used to configure another DI-206 with exactly the same settings, or as a backup before you make major changes to the configuration.

```
7.9 System Settings Backup/Restore
=====

1. Backup System Settings...
2. Restore System Settings...

EXIT
```

Backup System Settings

```
7.9.1 Backup System Settings
=====
Remote IP Address [0.0.0.0 ]
TFTP Time Interval [0 ]
File Name [ ]
Start Backup

EXIT
```

Items in the window are described below:

- **Remote IP Address** – This is the IP address of the TFTP server on which you wish to store the settings file.
- **TFTP Time Interval** – The time between requests to occupy TFTP server time. If the router doesn't receive a response (ACK) from the TFTP server within the time interval defined here, it will assume the request has been dropped and send another.
- **File Name** – Specifies the complete path and filename on the TFTP server for the settings file.

Restore System Settings

```
7.9.2 Restore System Settings
=====
Remote IP Address [0.0.0.0 ]
TFTP Time Interval [0 ]
File Name [ ]
Start Restore

EXIT
```

Items in the window are described below:

- **Remote IP Address** – This is the IP address of the TFTP server on which you wish to restore the system settings file.
- **TFTP Time Interval** – The time between requests to occupy TFTP server time. If the router doesn't receive a response (ACK) from the TFTP server within the time interval defined here, it will assume the request has been dropped and send another.
- **File Name** – Specifies the complete path and filename on the TFTP server for the settings file.

PROM System Configuration

The PROM program is run before the normal console (runtime) configuration program in the router's Flash Memory. Thus, the PROM System Configuration can be used if there are problems with the router's console program.

Specifically, the PROM Configuration program has procedures to initialize the administration parameters and the LAN IP address of the router in order to allow the console software in the router's flash memory to be replaced if it has been damaged or deleted.

To enter the **PROM System Menu**, press Ctrl+C during the Router's POST procedure. The following menu will appear:



System Configuration

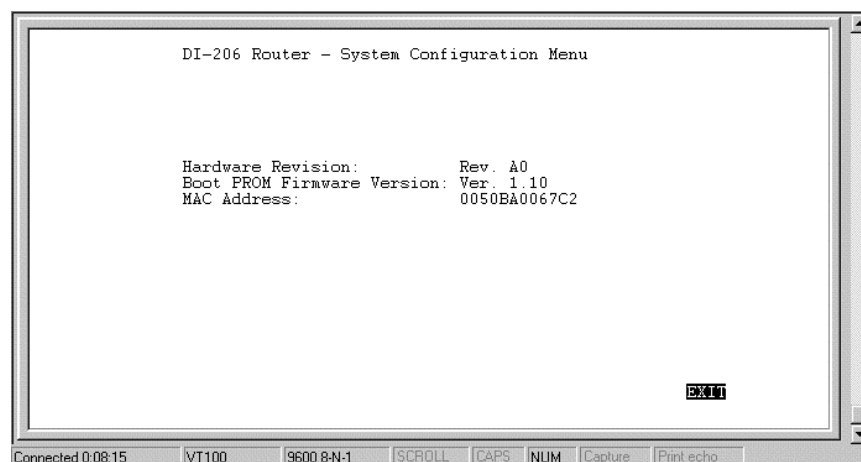

The parameters are described as follows:

- **Hardware Revision** – This is the version ID of hardware used in this router.
- **Boot PROM Firmware Version** – This is the version ID of firmware used in this router.
- **MAC Address** – This is the physical address for this router.

TCP/IP Parameters Configuration

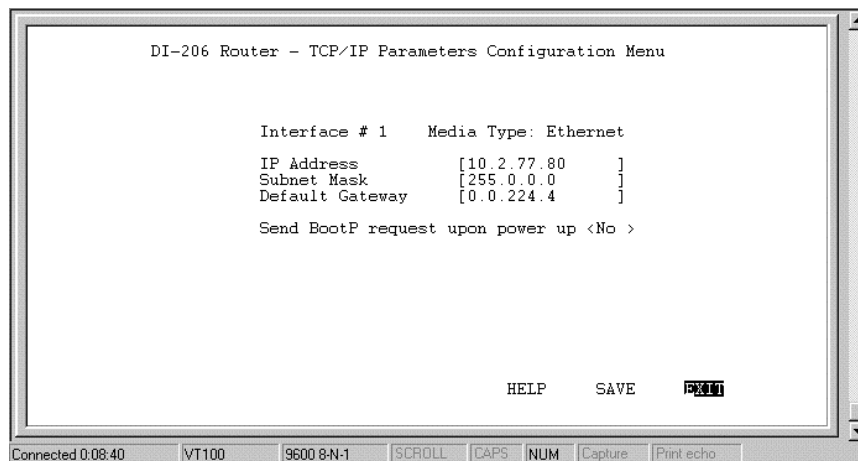

The parameters are described as follows:

- **Interface** – The LAN interface must use Ethernet/Fast Ethernet and is displayed here. This setting cannot be adjusted.
- **IP Address** – This is the router's IP Address for the LAN interface.
- **Subnet Mask** – This mask shows how the LAN is to be divided into network, subnet, and host parts.
- **Default Gateway** – This is the default gateway for the LAN. If this router will be the default gateway for the LAN, then the address should be 0.0.0.0.
- **Send BootP request upon power up** – If set to *Yes*, when the router boots up, it will attempt to acquire the path to the image file, the TFTP server IP Address and the routers own IP Address.

System Reset

The system reset function enables you to reset the DI-206 without powering off. Some setting changes require a system reset in order for them to take effect.

A system reset will not affect the router's settings, but will clear all tables including the routing table and all SNMP counters and tables. It is also used to initiate a software update.

Software Update

The Software Update option is used to change the software in the flash memory of the router. This is the runtime software that is configured by the console and is used to setup the router and is described in full in the preceding chapter.

The runtime software should only be updated if you are encountering problems with your current runtime software or you are certain your runtime software is lacking functionality contained in a more recent version.

Downloading new software will only replace the runtime software and will not affect any configuration settings you have made. Upon running the new software, the router will be configured exactly as you had it before downloading the new software.

The runtime software (image file) must be stored on a TFTP server and accessed via the LAN.

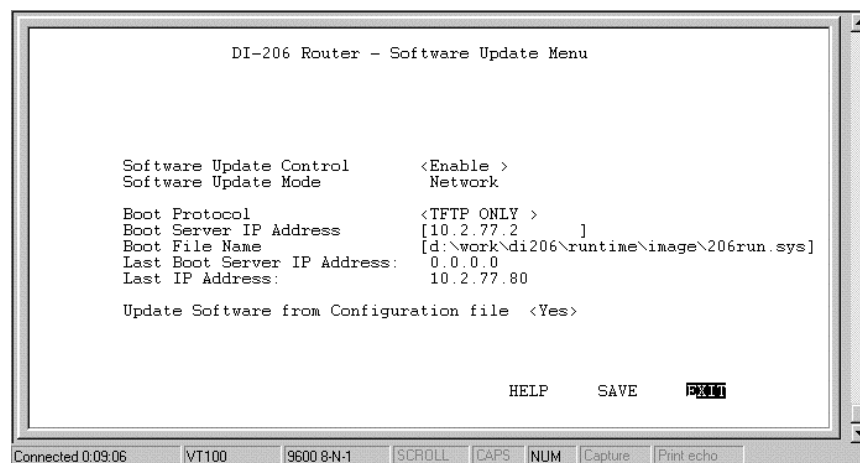

Items listed in the above menu are described as follows:

- **Software Update Control** – This toggles disable and enable.
- **Software Update Mode** – This specifies downloading the image file from a Network server on the local LAN.
- **Boot Protocol** – This setting is for a local network download and has two options *TFTP* and *BootP&TFTP*.
 - *TFTP* – A File Transfer Protocol. Using this setting assumes all other items on this screen have been filled out.
 - *BootP&TFTP* – BootP is run first and sends your router IP Addresses for the TFTP server and the router, and tells the router the path to the software update (image file). Then TFTP will be used to download the image file.
- **Boot Server IP Address** – This specifies the IP address of the server to be used to download the image file.
- **Boot File Name** – This specifies a complete path and filename on the TFTP server. If you choose to use a configuration file, this setting must show the path

and filename to the configuration file. If you are not using a configuration file, this must show the path and filename to the software update image file.

- **Last Boot Server IP Address** – This shows the last boot server used to download an image file. This is for reference only.
- **Last IP Address** – This shows the last IP address used for the LAN interface. Again, this is for reference only. The LAN port must have an IP address in order to access the TFTP server via the LAN network.
- **Update Software from Configuration File** – Either *Yes* or *No*. If *Yes*, the software update procedure will try to access a configuration file located at the path defined in the above Boot File Name. Please ensure that the path and file name of the image file is listed in the configuration file. If set to *No*, the update procedure will try to find an image file at the Boot File Name path. Please see Appendix F, “*Configuration File*” for more information about configuration files.

After the parameters are set in the **Software Update** screen, **SAVE** the changes, **EXIT**, and perform a System Reset or Execute Bootload to begin the software download process.

After the new runtime software has been downloaded, the router will automatically start up using the new software with the Software Update Control setting *Disabled* to avoid a downloading loop.

EEPROM Factory Reset

Performing a factory reset erases all settings and tables. All configuration changes ever made to the router will be deleted. The router will be set to the factory defaults it was shipped with and will no longer have an IP address.

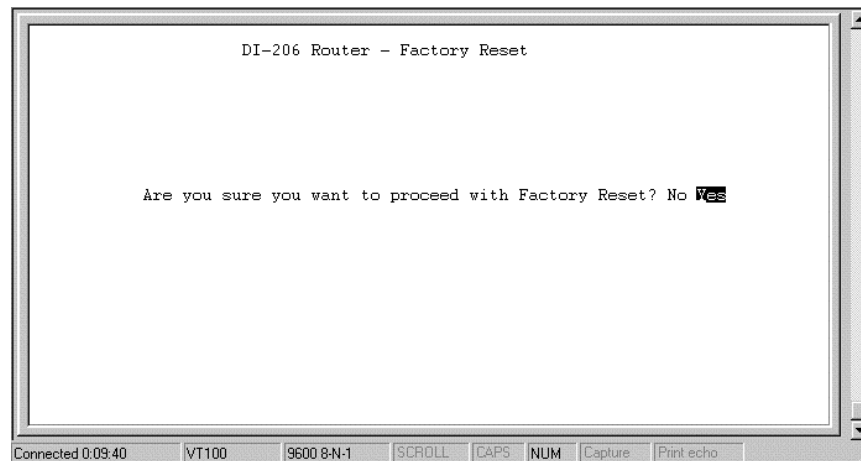

Please make sure you wish to wipe out all settings and configure the router from scratch before you perform a factory reset.

Execute Bootload

Choosing this option accepts the changes made in the PROM program and begins the router's startup sequence.

Executing a bootload can also begin the Software Update procedure, if enabled.

Using Telnet

The DI-206 router can be configured and managed using telnet. Telnet accesses the same built-in configuration program as the RS-232 Diagnostic port console connection. As such, all settings that can be adjusted through the console can also be configured using Telnet.

Telnet Configuration

In order to use telnet, the DI-206 router must first be configured using a console connected to the RS-232 Diagnostic port. Depending on the placement of the management station using telnet, the initial configuration requirements for the router are as follows:

Using Telnet via LAN

Preparing the router for management by telnet over the LAN only requires enabling the LAN port, enabling telnet, and assigning the LAN port an IP address. To do this:

1. Connect a console to the RS-232 Diagnostic port on the front panel of the router and run a terminal emulation program (for more information, see *Connecting the Console to the Router* and *Setting Up the Console* sections of this manual).
2. Enable the LAN port in the **Interface Configuration** sub-menu.
3. Assign an IP address to the LAN port in the **Network Configuration** sub-menu.
4. Enable Telnet in the **Advanced Functions** submenu.
5. Connect the router to the LAN.

The router can now be accessed via the LAN by the included Windows-based Configuration program, Telnet and SNMP management applications. For more detailed information regarding these procedures, please refer to the *Connecting the Router* section of this manual. For more information about the submenus, please refer to the *Configuration and Management* section of this manual.

Using Telnet via ISDN

Preparing the router for management by telnet over ISDN lines requires more initial configuring of the router via the console.

To do this, you must configure an ISDN port for dial-in users. Please refer to the **Interface Configuration, ISDN** submenu section of this manual.

System Timeout

When you are connected to your DI-206 via Telnet, there is a system timeout (in the **System Information** submenu), adjustable to a maximum of 90 minutes. If you are logged onto the device and leave it inactive for this timeout period, the router will automatically disconnect you.

Using RADIUS Authentication

In addition to the dial-in user list, which can hold up to eight users, this model also supports an external authentication server which may provide password storage and usage accounting for thousands of users.

Installing a RADIUS Server

To use RADIUS authentication, you will need to have a UNIX or Windows NT-based machine on your network to act as a `radiusd` server, as well as a copy of the `radiusd` server program itself. You can obtain a copy of the RADIUS software, along with documentation for the server, at

<http://www.livingston.com/marketing/products/radius.html>

or at:

<ftp://ftp.livingston.com/pub/le/radius/>

Configuring the DI-206 for RADIUS Authentication

To configure the DI-206 to use the RADIUS server set up in the previous section, go to the **Main Menu** in the console program and choose *Advanced Functions* and then *RADIUS Configuration*.

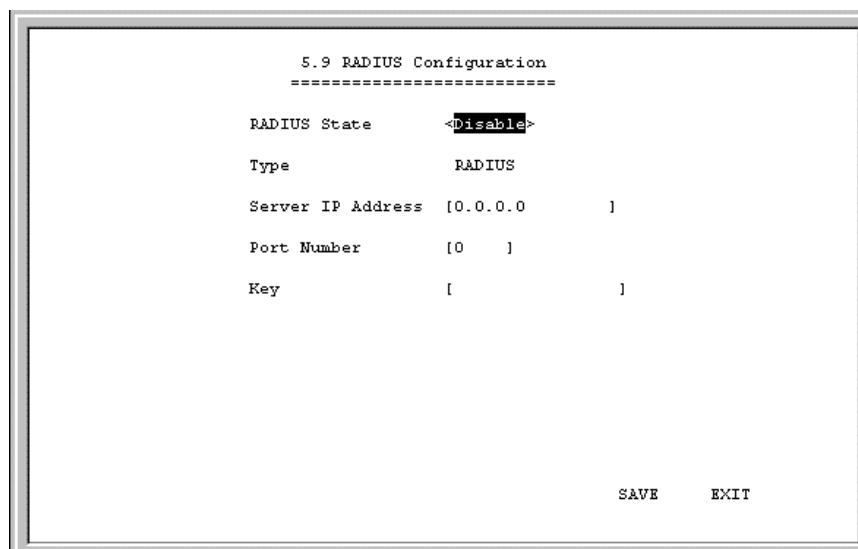

Items in the above submenu are described as follows:

- ◆ **RADIUS State** – Enables or disables RADIUS.

- ◆ **Type** – Refers to the type of external password protocol. Currently, only Radius is supported.
- ◆ **Server IP Address** – This is the IP Address of your UNIX or NT-based Radius server.
- ◆ **Port** – The port number for the Radius server. The standard port number specified by RFC 1700 is 1812 (shown above).
- ◆ **Key** – This is a shared secret used to identify the DI-206 as a valid Radius client.

The Key password should be stored in the `client` file in the RADIUS server's `/etc/raddb` directory. Lines of the form

```
# Client Name          Key
#-----
192.168.0.1           dlink_customer
```

should be added to the `client` file. The Client Name field in the file gives the IP address of the DI-206, and the Key field should be the same as the Key field in the **Radius Configuration** submenu.

After a RADIUS server has been configured, the DI-206 will use it to authenticate all users instead of checking it's internal Dial-Up User Profile.

Adding Users to the RADIUS Database

The DI-206 only uses the RADIUS database for user authentication. Except for the User Name, Password and Framed_IP_Address fields, most standard RADIUS attribute fields are ignored by the DI-206.

To add a user to the RADIUS database, edit the `users` file in the RADIUS server's `/etc/raddb` directory, and add a line similar to the following:

```
joesuser          Password = "joepassword"
```

Each user should have a user name/password record in the Users database. It is also possible to configure an IP address for each user by adding a line in the Users database similar to the following:

```
Ip user          Password = "iusespecificip", Framed_IP_Address =
192.168.0.117
```

Appendix A - Troubleshooting

This chapter contains some problems you may run into when using your router. After each problem description, we have provided some instructions to help you diagnose and solve the problem.

Some Common Problems With the DI-206

None of the LEDs are on when you power up the router

- ◆ Check the power cord and the power supply and make sure it is properly connected to your DI-206. If the error persists you may have a hardware problem. In this case you should contact technical support.

Connecting the RS-232 cable, cannot access the console program

- ◆ Check to see if the DI-206 is connected to your computer's serial port.
- ◆ Check to see if the communications program is configured correctly. The communications software should be configured as follows:
 - ◇ VT100 terminal emulation.
 - ◇ 9600 Baud rate.
 - ◇ No parity, 8 Data bits, 1 Stop bit.

Problems With the ISDN Line

If you are having problems making a connection through the ISDN line, try performing a Loopback Test (in the console program choose *System Maintenance, Diagnostic, Loopback Test*). If the loopback test succeeds then your physical connection to your phone company is ok and the problem probably lies in your ISDN settings (located in the console program under *Interface Configuration, ISDN*). Alternatively, the problem could be with the router or computer you are trying to call.

Problems with the LAN Interface

Can't PING any station on the LAN

1. Check the LAN LED on the front panel of your router. If it is on, then the link is up. If it is off, then check the cables connecting the router to your LAN.
2. Make sure the LAN is enabled in the **Interface Configuration, LAN** submenu of the console program.

3. Verify with your network administrator that the IP address and the IP subnet mask configured in the **Network Configuration, IP Configuration, IP Stack Configuration, LAN** submenu of the console program are valid for that LAN.
4. Check the physical Ethernet cable, and make sure the connections on the router and the hub or station are secure.
5. Check to make sure an end station IS NOT connected to the Uplink port or that a hub IS connected to the Uplink port using straight-through cables.
6. Check to make sure the wires in the cable are attached to the appropriate pins in the RJ-45 connector

Appendix B - IP Concepts

This appendix describes some basic IP concepts, the TCP/IP addressing scheme and show how to assign IP Addresses.

When setting up the router, you must make sure all ports to be utilized on the router have valid IP addresses. Even if you will not use the ISDN or WAN ports, you should, at the very least, make sure the LAN port is assigned a valid IP address. This is required for telnet, in-band SNMP management, and related functions such as "trap" handling and TFTP firmware download.

IP Addresses

The Internet Protocol (IP) was designed for routing data between network sites all over the world, and was later adapted to allow routing between networks (often referred to as "subnets") within any site. IP includes a system by which a unique number can be assigned to each of the millions of networks and each of the computers on those networks. Such a number is called an IP address.

To make IP addresses easy to understand, the originators of IP adopted a system of representation called "dotted decimal" or "dotted quad" notation. Below are examples of IP addresses written in this format:

201.202.203.204 189.21.241.56 125.87.0.1

Each of the four values in an IP address is the ordinary decimal (base 10) representation of a value that a computer can handle using eight "bits" (binary digits — 1s and 0s). The dots are simply convenient visual separators.

Zeros are often used as placeholders in dotted decimal notation; 189.21.241.56 can therefore also appear as 189.021.241.056.

IP networks are divided into three classes on the basis of size. A full IP address contains a network portion and a "host" (device) portion. The network and host portions of the address are different lengths for different classes of networks, as shown in the table below.

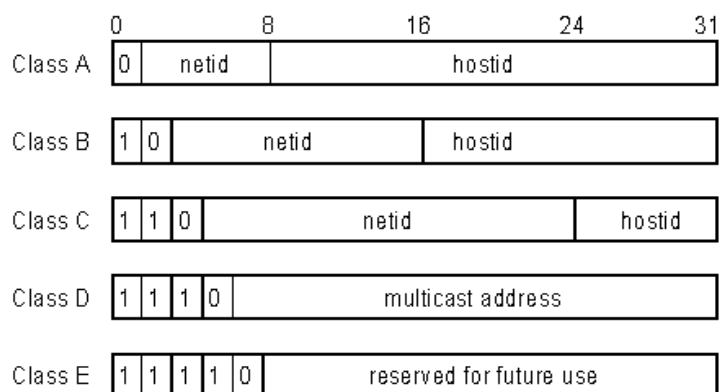

Networks attached to the Internet are assigned class types that determine the maximum number of possible hosts per network. The previous figure illustrates how the net and host portions of the IP address differ among the three classes. Class A is assigned to networks that have more than 65,535 hosts; Class B is for networks that have 256 to 65534 hosts; Class C is for networks with less than 256 hosts.

IP Network Classes			
Class	Maximum Number of Networks in Class	Network Addresses (Host Portion in Parenthesis)	Maximum Number of Hosts per Network
A	126	1(.0.0.0) to 126(.0.0.0)	16,777,214
B	16,382	128.1(.0.0) to 191.254(.0.0)	65,534
C	2,097,150	192.0.1(.0) to 223.255.254(.0)	254

Note: All network addresses outside of these ranges (Class D and E) are either reserved or set aside for experimental networks or multicasting.

When an IP address's host portion contains only zero(s), the address identifies a network and not a host. No physical device may be given such an address.

The network portion must start with a value from 1 to 126 or from 128 to 223. Any other value(s) in the network portion may be from 0 to 255, except that in class B the network addresses 128.0.0.0 and 191.255.0.0 are reserved, and in class C the network addresses 192.0.0.0 and 223.255.255.0 are reserved.

The value(s) in the host portion of a physical device's IP address can be in the range of 0 through 255 as long as this portion is not all-0 or all-255. Values outside the range of 0 to 255 can never appear in an IP address (0 to 255 is the full range of integer values that can be expressed with eight bits).

The network portion must be the same for all the IP devices on a discrete physical network (a single Ethernet LAN, for example, or a WAN link). The host portion must be different for each IP device — or, to be more precise, each IP-capable port or interface — connected directly to that network.

The network portion of an IP address will be referred to in this manual as a network number; the host portion will be referred to as a host number.

To connect to the Internet or to any private IP network that uses an Internet-assigned network number, you must obtain a registered IP network number from an Internet-authorized network information center. In many countries you must apply through a government agency, however they can usually be obtained from your Internet Service Provider (ISP).

If your organization's networks are, and will always remain, a closed system with no connection to the Internet or to any other IP network, you can choose your own network numbers as long as they conform to the above rules.

If your networks are isolated from the Internet, e.g. only between your two branch offices, you can assign any IP Addresses to hosts without problems. However, the Internet Assigned Numbers Authority (IANA) has reserved the following three blocks of IP Addresses specifically for private (stub) networks:

Class	Beginning Address	Ending Address
A	10.0.0.0	10.255.255.255
B	172.16.0.0	172.31.255.255
C	192.168.0.0	192.168.255.255

It is recommended that you choose private network IP Addresses from the above list. For more information on address assignment, refer to RFC 1597, *Address Allocation for Private Internets* and RFC 1466, *Guidelines for Management of IP Address Space*.

Subnet Mask

In the absence of subnetworks, standard TCP/IP addressing may be used by specifying subnet masks as shown below.

IP Class	Subnet Mask
Class A	255.0.0.0
Class B	255.255.0.0
Class C	255.255.255.0

Subnet mask settings other than those listed above add significance to the interpretation of bits in the IP address. The bits of the subnet mask correspond directly to the bits of the IP address. Any bit in a subnet mask that is to correspond to a net ID bit in the IP address must be set to 1.

Appendix C – IP Protocol and Port Numbers

Common Internet service protocols and IP port numbers.

IP Protocol Numbers

Protocol #	Protocol Name	Description
1	ICMP	Internet Control Message [RFC792]
2	IGMP	Internet Group Management [RFC1112]
6	TCP	Transmission Control [RFC793]
8	EGP	Exterior Gateway Protocol [RFC888,DLM1]
9	IGP	any private interior gateway [IANA] (used by Cisco for their IGRP)
17	UDP	User Datagram [RFC768,JBP]
46	RSVP	Reservation Protocol [Bob Braden]
88	EIGRP	EIGRP [CISCO,GXS]
115	L2TP	Layer Two Tunneling Protocol [Aboba]

IP Port Numbers

Service	TCP	UDP	Notes
FTP	21		File Transfer
Telnet	23		
SMTP	25		Simple Mail Transfer
DNS	53	53	Domain Name Server
Finger	79		
WWWHTTP	80		World Wide Web HTTP
POP3	110		Post Office Protocol – Version 3
	137	137	NetBios Name Service
	138	138	NetBios Datagram Service
	139	139	NetBios Session Service
SNMP		161	
SNMP Trap		162	

Appendix D - Technical Specifications

General	
Ports	
Number of Ports: 6 Ethernet ports 2 Analog phone ports 1 Console port	RJ-45 RJ-11 DB-9 RS-232 DCE
LED Readout	
Power	
Test	
ISDN	Link, B1, B2
Ethernet	Col, Link/Act - Uplink, 1,2,3,4,5,
Phone	1,2
LAN	
Standard	IEEE 802.3 10BASE-T Ethernet
LAN Protocol	CSMA/CD
Data Transfer Rates	10Mbps (half duplex)
Network Cables	
10BASE-T: 2-pair UTP Cat.3, 4, 5 (100m max. length)	EIA/TIA-568 100-ohm screened twisted-pair
ISDN	
Standard PPP/Multi-link PPP	
ISDN Protocols	
ISDN speeds	ISDN BRI: up to 128,000bps
ISDN Interface	
1 ISDN BRI port:	64Kbps B channel x 2 16Kbps D channel x 1
ISDN network Compatibility	
Europe and Asia: Supports DSS1, EuroISDN and Taiwan	DGT switches, and Siemens EWSD switches
Data Compression	Hi/fn™ LZS (Stac)
Compression Ratio:	4 to 1
Routing	
IP Packet Routing	TCP/IP with RIP-1 and RIP-2, static routes
IPX Packet Routing (DI-206M)	Novell IPX with RIP, SAP, Spoofing
Bridging	
Transparent MAC-layer bridging (DI-206M)	802.1d Spanning Tree (DI-206M)
Other Protocols	
UDP, TCP, NAT, DHCP, BAP/BACP, ICMP	
Management	
SNMP	MIB-II
Security	
PAP, CHAP Administrative password Firewall filtering RADIUS	

Physical & Environmental	
DC Input: External DC power adapter	18V 750mA unregulated or regulated
Power Consumption	8.5W max.
Ventilation	Fanless
Operating Temperature	0 - 50 C (32 - 122 F)
Storage Temperature	-25 - 55 C (-13 - 131 F)
Humidity	5% - 95% non-condensing
Dimensions	220mm x 166mm x 45mm (8 3/5" x 6 1/2" x 1 3/4")
Emissions (EMI)	FCC Class B, VCCI Class B, CE Mark
Safety	UL (UL1950), CSA (CSA950)

Appendix E – Country ID Numbers

Please refer to the list below for country ID numbers used to configure the ISDN interface of the router.

00 : International	30 : Thailand
01 : Taiwan	31 : Turkey
02 : Germany	32 : Greece
03 : Sweden	33 : Argentina
04 : France	34 : Austria
05 : Switzerland	35 : Bangladesh
06 : Holland	36 : Belgium
07 : Finland	37 : Brazil
08 : Denmark	38 : Bulgaria
09 : U.K.	39 : Canada
10 : Australia	40 : Chile
11 : Norway	41 : Colombia
12 : Italy	42 : Egypt
14 : China	43 : Hong Kong
15 : Singapore	44 : India
16 : Malaysia	45 : Indonesia
17 : Spain	46 : Iran
18 : Portugal	47 : Iraq
19 : Israel	48 : Ireland
20 : Poland	49 : Mexico
21 : Czech Republic	50 : Peru
22 : Hungary	51 : Portugal
23 : Slovenia	52 : Romania
24 : Estonia	33 : Russia
25 : Slovakia	54 : Saudi Arabia
26 : New Zealand	55 : South Africa
27 : South Korea	57 : Ukraine
29 : Philippines	58 : Sri Lanka

Appendix F – Configuration File

The router can be configured when performing a Software Update through a configuration file.

The configuration file can hold many settings for the router including IP Addresses for all ports, path to the boot server, and various port settings.

The configuration file is very useful if you wish to update your software and keep all or most of your settings the same.

The configuration file should be saved with the extension .SYS in the same directory as the runtime image file (software update file).

An example configuration file is shown below. Please note that:

: Comment. This line describes the actual configuration in the next line.
You can also use this feature to mask items you don't need to be configured (rather than deleting them).

Format: Keyword <Space> Parameter. For example the very last line:

ip-stat disable

ip-stat is the keyword as explained in the # (comment) line above as meaning IP routing statistics.

disable is the parameter you set.

Configuration File Example

```
# The system configuration file for D-Link DI-206 Router

# DI-206 runtime image file name (software update path and file name)
di206-image d:\project\di206\runtime\image\206run\206run.hdr

# sysname (string name)
sysname DI-206 Router
# syscontact (string name)
syscontact Engineering Administrator, Admin
# syslocation (string name)
syslocation Myson Building 6th floor
# systimeout setting in minutes (0 means no timeout)
systimeout 10
# telnet stat (enable/disable)
telnet enable
# ip routing stack (enable/disable)
ip-routing enable

# interface decription (string name)
lan-port-1 System Lan Interface
# port stat (enable/disable)
port-stat enable
# ip address
ip-address 202.39.74.119
# subnet mask
ip-netmask 255.255.255.0
# routing protocol type (0:RIPv1, 1:RIPv2, 2:RIPv1&2)
```



```
routing-type 2
# routing operating mode (0:None, 1:Listen, 2:Talk, 3:Both)
operating-mode 0
# ip routing stat (enable/disable)
ip-stat enable
```

Index

- A**
- A/B Adapter 1
 - Access Right 27
 - Admin[istration] Configuration 66
 - Advanced Functions 29
 - Age 72
 - ARP request 31
 - Auth Type 30
 - automatic timeout 17
- B**
- B (Bearer) channels 29
 - Bandwidth Allocation Control Protocol 2
 - Bandwidth Allocation Protocol 2
 - Bandwidth on Demand 29
 - Bandwidth On Demand *See* BOD
 - BAP *See* Bandwidth Allocation Protocol
 - B-channel 30
 - BOD 2
 - Boot File Name 88
 - Boot Protocol 87
 - Boot Server IP Address 87
 - BootP&TFTP* 87
 - Bridging 1, 2
- C**
- Caller ID 34, 37
 - Challenge Handshake Authentication Protocol *See* CHAP
 - CHAP 2, 20
 - Code 74, 75
 - Configuration 16
 - Configuration File 102
 - Configuration File Example 102
 - Connection Test 77
 - connections 29
 - Console 9, 10
 - Console program 16
 - Console Program 10, 16
 - Counter 67, 71
- D**
- D channel 29
 - Data 76
 - default gateway 37
 - default login 16
 - default next hop router 31
 - DHCP 38
 - Diagnostic 77
 - Diagnostic port 9
 - Dial on Demand 32
 - Dial On Demand 2
 - dial-in 29, 33
 - dial-in network connection 30
 - Dial-In User Connections 29
 - Dial-in User Profile 63
 - Dial-In User Profile 29, 32
 - Dial-in users 29
 - dial-out connections 29
 - Dial-Out Network Connections 30
 - Direction 36
 - DNS 61
 - DNS Cache State 61
 - DNS Configuration 61
 - DNS Domain Name 61
 - DNS IP 40
 - Domain Name 40
 - Dynamic Host Configuration Protocol 2
 - Dynamic IP Pool 39
 - Dynamic NAPT 57
 - Dynamic NAT 56
- E**
- EEPROM 16
 - Event/Error Log 73
 - Execute Bootload 88, 89
- F**
- Factory Reset 88
 - fax calls 29
 - Filter Configuration 42
 - Filter State of Interface 43
 - firewall 50
 - flash memory 87
 - Flash memory 16
 - Forward DNS queries to 61
 - Forwarding (LAN) 23
 - Front panel LED's 6
 - FTP servers 58
- G**
- Gateway 25, 26, 40
 - Gateway address 31
 - Gateway IP address 51
 - Global Interface 55
 - global IP address 50
- H**
- Hops 25
 - Host Name 62
- I**
- ICMP 47

Idle Time	37	Microsoft NetMeeting	55
IGMP.....	24	MIP	47
image file.....	87	MLPPP	63
impostor.....	49	Multicast Protocol	24
Initial Configuration	12, 16	Multi-Link PPP	63
installation	108	Multiple Home Configuration	47
<i>Interface</i>	31, 37	<i>N</i>	
Interface Configuration	18, 30	NAPT	51
Internet	3, 31	Dynamic NAPT.....	56
IP Address	23, 28, 50, 86	Static NAPT	55
IP Address Supply	35	NAT	50
IP Addresses.....	96	Dynamic NAT	55
IP Concepts	96	Static NAT	55
IP Filter	43, 45	NAT Configuration	50
IP Multicasting	24	NAT IP Pool	54, 56, 57, 58
IP Network Classes	96	Netmask.....	23, 40
IP Networking	26	Network Configuration.....	21
IP Port Numbers	98	network management.....	108
IP Protocol.....	98	next hop router	31
IP Protocol Numbers	98	<i>O</i>	
<i>IP STACK</i>	23	Offset.....	45
IP Stack Configuration	22	Operation.....	47
IP Static Route.....	25	<i>P</i>	
IP Static Route Table.....	26	PAP	2, 20
IP Static Routes	31	Password	30
IPX	2	Password Authentication Protocol	<i>See</i> PAP
ISDN	6, 19, 22	physical port.....	30
ISDN Counter Table.....	69	Ping Test	78
ISDN Interface	30	Plain Old Telephone Service.....	<i>See</i> POTS
ISDN L1	37	Point-to-Point Protocol/Multilink Protocol	<i>See</i>
ISDN line	29	PPP/MP	
<i>ISDN</i> submenu.....	30	Port.....	58, 63, 75, 93
ISP.....	31	Port Numbers	98
<i>K</i>		Interface	76
Key	63, 93	POST	16, 85
<i>L</i>		POTS.....	1
LAN.....	2, 3, 4, 6, 19, 22, 26, 48, 94, 95	PPP/MP	2
LAN Counter Table.....	68	private network.....	50
LAN Port.....	13	private networks	53
Layer 2 Filter.....	43, 44	PROM System Configuration.....	85
Lease Time	40	<i>PROM System Menu</i>	85
<i>Listen</i>	24	Protocol Type.....	47
Local Area Network	<i>See</i> LAN	<i>R</i>	
Local Interface.....	55	Radius.....	63
local IP address	50	Radius Configuration	63
Log and Trace	70, 73	Radius server.....	33, 63
Lookup Host Table.....	61	Range	33, 40
<i>M</i>		Rem CLID	34
MAC address.....	31	Remote Access	32
MAC Address.....	41, 50	Remote Access Configuration.....	29
Main Menu	16	remote connections.....	29
Management	16	Remote Dial-in Users	1, 3
Mask.....	45	Remote Network Connections.....	30
Menus		Remote Network Profile.....	30, 31
Main	16		

Remote Network Profiles	30	System Location	18
Remote networks	30	System MAC Address	18
Remote Node	1, 2	System Maintenance.....	66
Remote Operation Overview	29	System Name.....	18
Retry Count	33	System Object ID	17
Retry Time.....	33	System Reset	86, 88
Router Configuration Utility.....	13, 80	System Restart.....	81
Routing Mode.....	24	System Status	67
Routing Protocol	23	System Up Time.....	17
routing table.....	31		
RS-232.....	2, 9, 12, 90, 94	<i>T</i>	
runtime software	87	<i>Talk</i>	24
<i>S</i>		TCP/IP.....	1, 2, 3, 108
SAVE	88	TCP/IP Parameters Configuration.....	86
security	50	Telecommuting.....	3
Send BootP request	86	telephone jacks	29
Set Peer IP as Default Gateway.....	37	telephone number	31
Simple Network Management Protocol <i>See</i>		Telnet	2, 5, 9, 16, 26, 90, 91
SNMP		Using Telnet via ISDN.....	90
Single User Account.....	1, 3	Using Telnet via LAN.....	90
SMT	94	Telnet Configuration	90
SNMP.....	2, 26, 27	Telnet Enable	60
SNMP Agent Configuration	26	TFTP	87
SNMP Authenticated Trap	28	TFTP server	80, 87
SNMP Community	27	Time	75
SNMP Community String.....	27, 28	Timeout	18
SNMP Trap Manager	28	Trace Buffer	75
Software Update	80, 87	Translation Mode	55
Software Update Control.....	87, 88	Transparent Bridging.....	<i>See</i> Bridging
Static ARP	49	<i>U</i>	
Static ARPs	31	<i>UNNUMBER</i>	23
Static IP Pool.....	41	Update Software from Configuration File ...	88
Static NAPT	58	User Profile	33
Static NAT	57	Username.....	30
Statistics	67	UTP	108
STP.....	108	<i>V</i>	
stub network	53	virtual circuit	30, 37
SUA.....	<i>See</i> Single User Account	visible computer	55
Subnet Mask	97	voice	29
System Contact.....	17	<i>W</i>	
System Description.....	17	WINS IP.....	40
System Information	17		
System ISDN Test	80		
System LAN Test	79, 83		

D-Link® Offices

AUSTRALIA	D-LINK AUSTRALASIA Unit 16, 390 Eastern Valley Way, Roseville, NSW 2069, Australia TEL: 61-2-9417-7100 FAX: 61-2-9417-1077 TOLL FREE: 1800-177-100 (Australia), 0800-900900 (New Zealand) URL: www.dlink.com.au E-MAIL: support@dlink.com.au, info@dlink.com.au
CANADA	D-LINK CANADA 2180 Winston Park Drive, Oakville, Ontario L6H 5W1 Canada TEL: 1-905-829-5033 FAX: 1-905-829-5223 BBS: 1-965-279-8732 FREE CALL: 1-800-354-6522 URL: www.dlink.ca FTP: ftp.dlinknet.com E-MAIL: techsup@dlink.ca
CHILE	D-LINK SOUTH AMERICA Isidora Goyenechea #2934 of 702, Las Condes, Santiago, Chile TEL: 56-2-232-3185 FAX: 56-2-2320923 URL: www.dlink.cl E-MAIL: ccasassu@dlink.cl, tsilva@dlink.cl
DENMARK	D-LINK DENMARK Naverland 2, DK-2600 Glostrup, Copenhagen, Denmark TEL: 45-43-969040 FAX: 45-43-424347 URL: www.dlink.dk E-MAIL: info@dlink.dk
EGYPT	D-LINK MIDDLE EAST 7 Assem Ebn Sabet Street, Heliopolis Cairo, Egypt TEL: 202-2456176 FAX: 202-2456192 URL: www.dlink-me.com E-MAIL: support@dlink-me.com, fateen@dlink-me.com
FRANCE	D-LINK FRANCE Le Florilege #2, Allee de la Fresnerie 78330 Fontenay Le Fleury France TEL: 33-1-30238688 FAX: 33-1-3023-8689 URL: www.dlink-france.fr E-MAIL: info@dlink-france.fr
GERMANY	D-LINK GERMANY Bachstrae 22, D-65830 Kriftel Germany TEL: 49-(0)6192-97110 FAX: 49-(0)6192-9711-11 URL: www.dlink.de BBS: 49-(0)6192-971199 (Analog) 49-(0)6192-971198 (ISDN) INFO LINE: 00800-7250-0000 (toll free) HELP LINE: 00800-7250-4000 (toll free) REPAIR LINE: 00800-7250-8000 E-MAIL: mbischoff@dlink.de, mboerner@dlink.de
INDIA	D-LINK INDIA Plot No.5, Kurla-Bandra Complex Road, Off Cst Road, Santacruz (E), Bombay - 400 098 India TEL: 91-22-652-6696 FAX: 91-22-652-8914 URL: www.dlink-india.com E-MAIL: service@dlink.india.com
ITALY	D-LINK ITALY Via Nino Bonnet No. 6/b, 20154 Milano, Italy TEL: 39-02-2900-0676 FAX: 39-02-2900-1723 E-MAIL: info@dlink.it URL: www.dlink.it
JAPAN	D-LINK JAPAN 10F, 8-8-15 Nishi-Gotanda, Shinagawa-ku, Tokyo 141 Japan TEL: 81-3-5434-9678 FAX: 81-3-5434-9868 URL: www.d-link.co.jp E-MAIL: kida@d-link.co.jp
RUSSIA	D-LINK RUSSIA Michurinski Prospekt 49, 117607 Moscow, Russia TEL: 7-095-737-3389, 7-095-737-3492 FAX: 7-095-737-3390 E-MAIL: vl@dlink.ru
SINGAPORE	D-LINK INTERNATIONAL 1 International Business Park, #03-12 The Synergy, Singapore 609917 TEL: 65-774-6233 FAX: 65-774-6322 URL: www.dlink-intl.com E-MAIL: info@dlink.com.sg
S. AFRICA	D-LINK SOUTH AFRICA Unit 2, Parkside 86 Oak Avenue Highveld Technopark Centurion, Gauteng, Republic of South Africa TEL: 27(0)126652165 FAX: 27(0)126652186 CELL NO: 0826010806 (Bertus Moller) CELL NO: 0826060013 (Attie Pienaar) E-MAIL: bertus@d-link.co.za, attie@d-link.co.za
SWEDEN	D-LINK SWEDEN P.O. Box 15036, S-167 15 Bromma Sweden TEL: 46-(0)8564-61900 FAX: 46-(0)8564-61901 E-MAIL: info@dlink.se URL: www.dlink.se
TAIWAN	D-LINK TAIWAN 2F, No. 119 Pao-Chung Road, Hsin-Tien, Taipei, Taiwan, R.O.C. TEL: 886-2-2910-2626 FAX: 886-2-2910-1515 URL: www.dlinktw.com.tw E-MAIL: dssqa@tsc.dlinktw.com.tw
U.K.	D-LINK EUROPE D-Link House, 6 Garland Road, Stanmore, London HA7 1DP U.K. TEL: 44-20-8235-5555 FAX: 44-20-8235-5500 BBS: 44-20-8235-5511 URL: www.dlink.co.uk E-MAIL: info@dlink.co.uk
U.S.A.	D-LINK U.S.A. 53 Discovery Drive, Irvine, CA 92618 USA TEL: 1-949-788-0805 FAX: 1-949-753-7033 INFO LINE: 1-800-326-1688 BBS: 1-949-455-1779, 1-949-455-9616 URL: www.dlink.com E-MAIL: tech@dlink.com, support@dlink.com

Registration Card

Print, type or use block letters.

Your name: Mr./Ms _____
 Organization: _____ Dept. _____
 Your title at organization: _____
 Telephone: _____ Fax: _____
 Organization's full address: _____

 Country: _____
 Date of purchase (Month/Day/Year): _____

Product Model	Product Serial No.	* Product installed in type of computer (e.g., Compaq 486)	* Product installed in computer serial No.

(* Applies to adapters only)

Product was purchased from:

Reseller's name: _____
 Telephone: _____ Fax: _____
 Reseller's full address: _____

Answers to the following questions help us to support your product:

1. **Where and how will the product primarily be used?**
 Home Office Travel Company Business Home Business Personal Use
2. **How many employees work at installation site?**
 1 employee 2-9 10-49 50-99 100-499 500-999 1000 or more
3. **What network protocol(s) does your organization use ?**
 XNS/IPX TCP/IP DECnet Other _____
4. **What network operating system(s) does your organization use ?**
 D-Link LANsmart Novell NetWare NetWare Lite SCO Unix/Xenix PC NFS 3Com 3+Open
 Banyan Vines DECnet Pathwork Windows NT Windows NTAS Windows '95
 Other _____
5. **What network management program does your organization use ?**
 D-View HP OpenView/Windows HP OpenView/Unix SunNet Manager Novell NMS
 NetView 6000 Other _____
6. **What network medium/media does your organization use ?**
 Fiber-optics Thick coax Ethernet Thin coax Ethernet 10BASE-T UTP/STP
 100BASE-TX 100BASE-T4 100VGAnyLAN Other _____
7. **What applications are used on your network?**
 Desktop publishing Spreadsheet Word processing CAD/CAM
 Database management Accounting Other _____
8. **What category best describes your company?**
 Aerospace Engineering Education Finance Hospital Legal Insurance/Real Estate Manufacturing
 Retail/Chainstore/Wholesale Government Transportation/Utilities/Communication VAR
 System house/company Other _____
9. **Would you recommend your D-Link product to a friend?**
 Yes No Don't know yet
10. **Your comments on this product?**

PLEASE
PLACE STAMP
HERE

TO: _____

D-Link®

Free Manuals Download Website

<http://myh66.com>

<http://usermanuals.us>

<http://www.somanuals.com>

<http://www.4manuals.cc>

<http://www.manual-lib.com>

<http://www.404manual.com>

<http://www.luxmanual.com>

<http://aubethermostatmanual.com>

Golf course search by state

<http://golfingnear.com>

Email search by domain

<http://emailbydomain.com>

Auto manuals search

<http://auto.somanuals.com>

TV manuals search

<http://tv.somanuals.com>