

D-Link Quick Installation Guide

DMC-805G



1000Base-T to mini-GBIC

Media Converter

Before Your Begin

This Quick Installation Guide gives step-by-step instructions for setting up the D-Link DMC-805G 1000Base-T to mini-GBIC Media Converter. The model you have purchased may appear slightly different from those shown in the illustrations. For more detailed information about the media converter, its components, making network connections and technical specifications, please refer to the User's Manual included with your media converter.

Check Your Package Contents

These are the items included with your DMC-805G purchase:



- **DMC-805G 1000Base-T to mini-GBIC Media Converter**



- **User Manual**



- **Quick Installation Guide**



Using a power supply with a different voltage rating will damage and void the warranty for

If any of the items are missing, please contact your reseller.

- **7.5V DC, 1.5A Power Adapter**

©2004 D-Link Systems, Inc. All rights reserved.
Trademarks or registered trademarks are the property of their respective holders. Software and specifications subject to change without notice.

1

Setup The DMC-805G Single Fiber Media Converter

As with any electric device, you should place the equipment where it will not be subjected to extreme temperatures, humidity, or electromagnetic interference. Specifically, the site you select should meet the following requirements:

- A. The ambient temperature should be between 32 and 104 degrees Fahrenheit (0 to 40 degrees Celsius).
- B. The relative humidity should be less than 90 percent, non-condensing.
- C. Surrounding electrical devices should not exceed the electromagnetic field (RFC) standards for IEC 801-3, Level 2 (3V/M) field strength.
- D. Make sure that the equipment receives adequate ventilation. Do not block the ventilation holes on each side of the media converter or the fan exhaust port on the side or rear of the equipment.
- E. The power outlet should be within 1.8 meters of the switch.

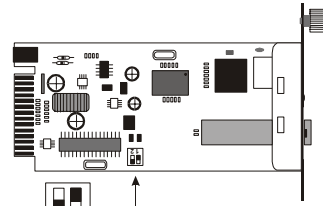

Switch 1 : On -> Forced Mode
 Off -> Auto Negotiation mode
 Switch 2 : On -> LLR enable
 Off -> LLR disable

Switch 1	On	Fiber Forced Mode
	Off	Fiber Auto-Negotiation
Switch 2	On	LLR Enable
	Off	LLR Disable

2

Connecting the power

1. This Converter is a plug-and-play device.
2. Connect the supplied AC to DC power adaptor with a power voltage of 7.5Vdc/1.5Amp to the receptacle on the rear panel of the converter, and then attach the plug into a standard AC outlet with a voltage range from 100 to 260 Vac.

3

Sliding Switch

There is a sliding switch for duplex mode setting for fiber port. Refer to the table below for more details.

4

Installing in a Chassis

The Converter can be fit into any of the expansion slots on a special designed chassis.

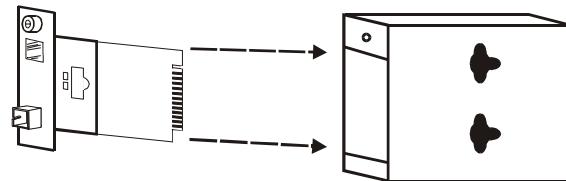

Unscrew and pull out the media converter board

• First, install the converter onto a carrier supplied with the chassis:

Step 1- Unscrew the carrier from the desired expansion slot on the chassis.

Step 2- Remove the screw on the converter as shown below.

Step 3- Fit the converter onto the carrier and use the screw to secure it.

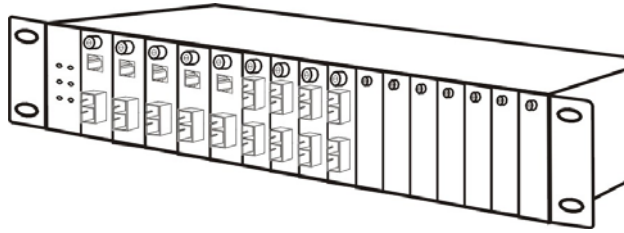

MEMO

5

LED Indicators

The LED indicators give you instant feedback on status of the converter:

POWER LINK/ACT

LEDs	State	Indication
Power (PWR)	Lights on	Power on
	Lights off	Power off
Link and Activity (LINK/ACT)	Lights on	Linking
	Lights Blinking	Data transmitting and receiving
	Lights off	Not Linking

Technical Support

You can find software updates and user documentation on the D-Link website. D-Link provides free technical support for customers within the United States and within Canada for the duration of the warranty period on this product. U.S. and Canadian customers can contact D-Link technical support on the D-Link website, or by phone.

Tech Support for customers within the United States:

D-Link Technical Support over the Telephone: (877) 453-5105

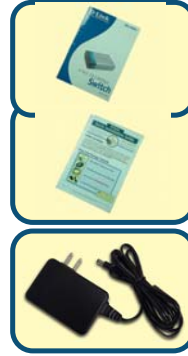

Sollten eine oder mehrere der oben aufgeführten Positionen fehlen, kontaktieren Sie bitte Ihren Händler.



Hinw
Netzadapt
Nennspan
Beschädig
sowie zum
Gantieans

©2004 D-Link Systems, Inc. Alle Rechte vorbehalten. Warenzeichen oder eingetragene Warenzeichen sind Eigentum der entsprechenden Inhaber. Änderungen an Software und Spezifikationen vorbehalten.

D-Link[®]
Building Networks for People

D-Link Quick Installation Guide

DMC-805G

1000Base-T to mini-GBIC

Converter



Voraussetzungen

Dieser Quick Installation Guide enthält eine schrittweise Anleitung zur Einrichtung des D-Link DMC-805G 1000Base-T to mini-GBIC Media Converter. Das von Ihnen erworbene Modell kann von der Abbildung leicht abweichen. Weitere Informationen zum DMC-805G, zu den Komponenten, technischen Spezifikationen und zum Aufbau von Netzwerkverbindungen entnehmen Sie dem mit dem Media Converter ausgelieferten Handbuch.

Prüfen des Paketinhalts

Mit dem Kauf des DMC-805G erhalten Sie folgendes Zubehör:



• DMC-805G 1000BASE-T to mini-GBIC Media Converter

• Benutzerhandbuch

Download from www.somanuals.com. All Manuals Search And Download.

• Quick Installation Guide

1 Einrichtung des DMC-805G Media Converters

Wie jedes elektrische Gerät darf der DMC-805G keinen Extremtemperaturen, Feuchtigkeit oder elektromagnetischen Störfeldern ausgesetzt werden. Bei der Standortwahl sind v.a. folgende Voraussetzungen zu beachten:

- A. Die Umgebungstemperatur sollte zwischen 0 bis 40 Grad Celsius betragen.
- B. Die relative Feuchtigkeit sollte unter 90% (nicht kondensierend) betragen.
- C. In der Umgebung aufgestellte elektrische Geräte dürfen die Feldstärkewerte gemäß der RFC-Standards für IEC 801-3, Level 2 (3V/M) nicht überschreiten.
- D. Stellen Sie sicher, dass die Einrichtung ausreichend belüftet wird. Die Lüftungslöcher an den Seiten des Geräts und die Lüfteröffnungen an der Seite bzw. auf der Rückseite des Media Converters dürfen in keinem Fall blockiert werden.
- E. Die Entfernung zur nächsten Stromquelle sollte max. 1,8 Meter betragen.

2 Anschließen an die Stromversorgung

1. Der Converter ist Plug-and-Play-fähig.
2. Verbinden Sie das mitgelieferte AC/DC-Netzadapter (7,5VDC/1,5Amp) mit dem Anschluss auf der Rückseite des Converters und. Schließen Sie den Stecker des Netzadapters danach an eine AC-Standardsteckdose (Spannung von 100 -260 VAC) an.

3 Gleitschalter

Die Duplexbetrieb-Einstellung für den Fiber Port erfolgt über einen Gleitschalter. Weitere Einzelheiten entnehmen Sie der Tabelle weiter unten.

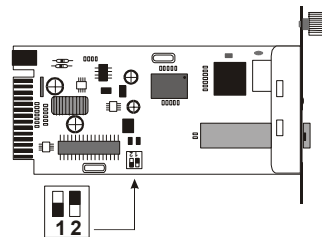

Switch 1 : On -> Forced Mode
Off -> Auto Negotiation mode
Switch 2 : On -> LLR enable
Off -> LLR disable

Schalter 1:	An	Glasfaser Standardmodus
	Aus	Glasfaser Auto-Negotiation
Schalter 2:	An	LLR aktiviert
	Aus	LLR deaktiviert

4 Gehäuseinstallation

Der Converter lässt sich im Erweiterungs SLOT eines Spezialgehäuses installieren.

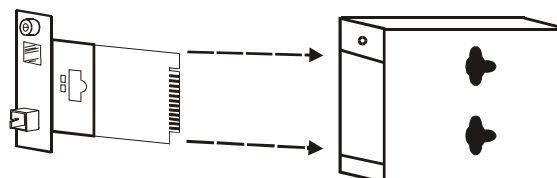

Lösen Sie die Schrauben des Media Converters und ziehen Sie das Board

• Installieren Sie den Converter zuerst in der mit dem Gehäuse ausgelieferten Trägervorrichtung:

Schritt 1 - Lösen Sie den Träger vom entsprechenden Erweiterungs SLOT des Gehäuses.

Schritt 2 - Entfernen Sie die Schraube des Converters wie unten dargestellt.

Schritt 3 - Befestigen Sie den Converter mit der Schraube an der Trägervorrichtung.

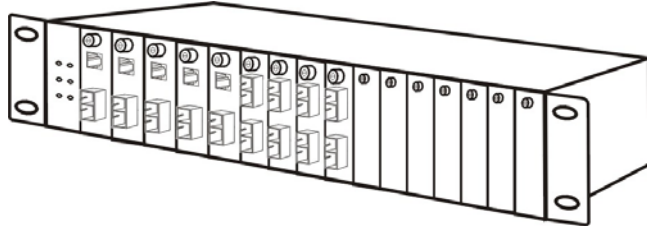

5

LED-Anzeigen

Anhand der LED-Anzeigen ist Converter-Status jederzeit ablesbar:

БМВО

ОГІІКІАСТ

LEDs	Status	Bedeutung
Stromversorgung (PWR)	An	Eingeschaltet
	Aus	Ausgeschaltet
LINK/ACT	An	Verbunden
	Blinkend	Datenübertragung oder Datenempfang
	Aus	Nicht verbunden

Technischer Support

Aktualisierte Versionen von Software und Benutzerhandbuch auf der Website von D-Link unter www.dlink.de.

D-Link bietet kostenfreie technische Unterstützung für Kunden Deutschlands, Österreichs, der Schweiz und Osteuropas.

Unsere Kunden können technische Unterstützung über unser Internet-Forum erhalten.

Vérifiez le contenu de l'emballage

Voici les éléments que doit contenir l'emballage du DMC-805G :



- Convertisseur de média monofibre 1000BASE-T/mini-GBIC DMC-805G

- Manuel utilisateur

- Guide d'installation rapide

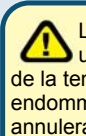

Si l'un des éléments ci-dessus manque, contactez votre revendeur.

- Adaptateur secteur 7.5V DC, 1.5A

©2004 D-Link Systems, Inc. Tous droits réservés. Les marques sont la propriété de leurs propriétaires respectifs. Le logiciel et les spécifications sont susceptibles d'être modifiés sans préavis.

D-Link[®]
Building Networks for People

D-Link Quick Installation Guide

Convertisseur de média monofibre

1000BASE-T/mini-GBIC



DMC-805G

Avant de commencer

Ce guide d'installation rapide indique étape par étape comment configurer le convertisseur de média double longueur d'onde monofibre 1000BASE-T/

mini-GBIC DMC-805G D-Link. Le modèle que vous avez acheté peut vous sembler légèrement différent de ceux des illustrations. Pour plus d'information détaillée sur le convertisseur de médias, ses composants, faire des raccordements de réseau et des caractéristiques techniques, reportez-vous s'il vous plaît au Manuel de l'Utilisateur inclus avec votre convertisseur de médias.

1 Configuration du convertisseur de média monofibre DMC-805G

Comme tout appareil électrique, le convertisseur de média doit être placé à un endroit où il ne sera pas soumis à des températures ou des humidités extrêmes ou encore à des perturbations électromagnétiques. Plus précisément, l'emplacement choisi doit remplir les conditions suivantes :

- A. La température ambiante doit être comprise entre 0 et 40°C.
- B. L'humidité relative doit être inférieure à 90% (sans condensation).
- C. Les appareils électriques voisins ne doivent pas dépasser les normes de rayonnement électromagnétique CEI-801-3, niveau 2 (3 V/m).
- D. Assurez-vous que l'équipement reçoit une ventilation adéquate. Ne bloquez pas les trous de ventilation de chaque côté du convertisseur de médias ou le port d'échappement de ventilateur sur le côté ou l'arrière de l'équipement.
- E. La prise de courant doit être à une distance maximale de 1,8 mètre du convertisseur.

Un commutateur à glissière permet de sélectionner le mode duplex pour le port fibre. Reportez-vous au tableau ci-dessous pour plus de détails.

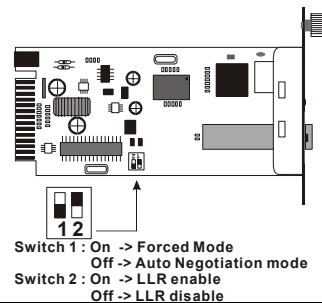

Inverseur 1	On	Mode forcé fibre
	Off	Négociation automatique fibre
Inverseur 2	On	Activation LLR
	Off	Désactivation LLR

4 Installation dans un châssis

Le convertisseur peut être installé dans n'importe quel emplacement d'extension d'un châssis spécial.

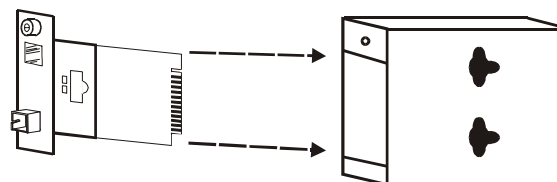

Dévissez et sortez la carte convertisseur

2 Alimentation

1. Ce convertisseur est un équipement « plug and play » (il est reconnu automatiquement par le système d'exploitation).
2. Branchez l'adaptateur secteur 7,5Vdc/1,5A sur le convertisseur (à l'arrière) et sur une prise de courant alternatif normale (100 à 260 V).

3 Configuration

Commencez par installer le convertisseur sur un support fourni avec le châssis :

Étape 1- Dévissez le support de l'emplacement d'extension désiré.

Étape 2- Retirez la vis du convertisseur comme indiqué ci-dessous.

Étape 3- Fixez la carte convertisseur au support avec la vis.

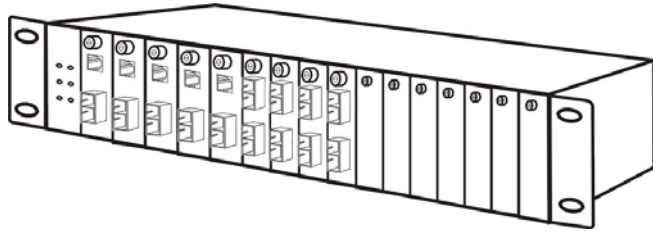

5

Voyants lumineux

Les voyants lumineux indiquent l'état du convertisseur :

БМВО

ОГПНКАСТ

LEDs	Status	Indication
Alimentation (PWR)	Allumé	Alimentation on
	Eteint	Alimentation off
LINK/ACT	Allumé	Liaison
	Clignotant	Émission ou réception de données
	Eteint	Pas de liaison

Assistance technique

Vous trouverez la documentation et les logiciels les plus récents sur le site web **D-Link**.

Le service technique est à votre disposition sur le site web **D-Link**® clients.

D-Link

Building Networks for People



 El uso de una fuente de alimentación con distinto voltaje puede ser perjudicial y anular la garantía de este producto.

Si falta alguno de estos componentes, por favor contacte con su proveedor.

©2004 D-Link Systems, Inc. Reservados todos los derechos. Las marcas o marcas registradas son propiedad de los respectivos titulares. El software y las especificaciones pueden ser modificados sin previo aviso.

1

Configurar el convertor de medios DMC-805G

Al igual que otro dispositivo eléctrico, el equipo no debe exponerse a elevadas temperaturas, humedad o interferencias electromagnéticas. La ubicación seleccionada ha de reunir las siguientes características:

A. La temperatura ambiental debería ser de 0 °C a 40 °C.

B. La humedad relativa debería ser inferior al 90 %, sin condensación.

C. Los dispositivos eléctricos cercanos no deberían sobrepasar los estándares de campo electromagnético (RFC) para nivel 2 (3V/m) de intensidad de campo IEC 801-3.

D. El equipo debe disponer de la adecuada ventilación. No se han de tapar las ranuras de ventilación que se encuentran a cada lado del convertor de medios ni el puerto de salida del ventilador en el lateral o parte trasera del equipo.

E. La toma de alimentación debería encontrarse a 1,8 metros del conmutador.

D-Link Quick Installation Guide

1000BASE-T to mini-GBIC



Antes de empezar

Esta guía de instalación rápida recoge las instrucciones detalladas para configurar el convertor de medios D-Link DMC-805G 1000BASE-T to mini-GBIC. El modelo que se ha adquirido puede presentar alguna diferencia respecto al que se muestra en las ilustraciones. Si se desea información más detallada sobre el convertor de medios, sus componentes, las conexiones de red y las especificaciones técnicas, consúltese el Manual del usuario que se incluye con el convertor de medios.

Comprobar el contenido del paquete

Estos son los elementos incluidos en el DMC-805G:



• DMC-805G 1000BASE-T to mini-GBIC Media Converter

• Manual del usuario

2

Conectar el alimentador

1. Este convertor es un dispositivo plug and play.
2. Conectar el adaptador de alimentación AC a DC con un voltaje de alimentación de 7,5 VDC/1,5 A en la conexión del panel trasero del convertor, y después introducir el enchufe en una base estándar AC de un voltaje de 100 a 260 Vac.

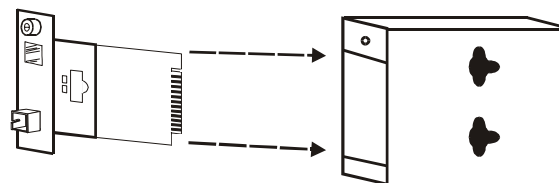

•Primero, instalar el convertor en el soporte suministrado con la carcasa:

Paso 1- Destornillar el soporte de un slot de expansión de la carcasa.

Paso 2- Sacar el tornillo del convertor, como se muestra en la imagen.

Paso 3- Colocar el convertor en el soporte y atornillarlo.

3

Conmutador deslizante

Hay un conmutador deslizante para establecer el modo duplex del puerto de fibra. Para más detalles véase la tabla siguiente.

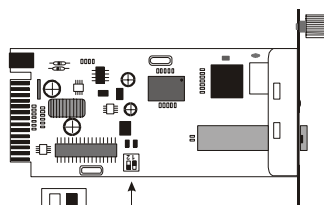

Switch 1 : On -> Forced Mode
Off -> Auto Negotiation mode
Switch 2 : On -> LLR enable
Off -> LLR disable

Conmutador 1	On	Fibra modo forzado
	Off	Fibra autonegociación
Conmutador 2	On	LLR activado
	Off	LLR desactivado

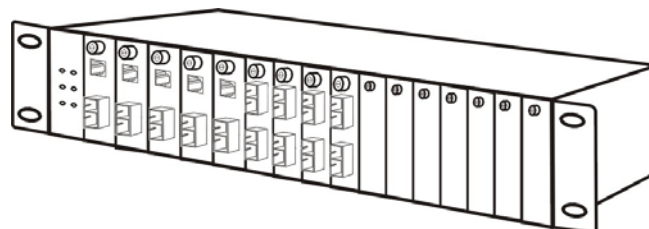

5

Indicadores LED

Los indicadores LED señalan el estado del convertor:

PMPO

ONIKACT

4

Instalar en una carcasa

El convertor puede colocarse en cualquiera de los slots de expansión de una carcasa de diseño especial

LEDs	Estado	Indicación
Encendido (PWR)	Luces encendidas	Encendido
	Luces apagadas	Parado
LINK/ACT	Luces encendidas	Con Link
	Intermitente	Transtiendo o recibiendo datos

Destornillar y sacar la placa base del convertor de medios



Se uno dei componenti dovesse risultare mancante, contattare il rivenditore

©2004 D-Link Systems, Inc. Tutti i diritti sono riservati. I marchi e i marchi registrati sono dei rispettivi proprietari. Software e specifiche soggetti a cambiamenti senza preavviso.

D-Link[®]
Building Networks for People

D-Link Quick Installation Guide

DMC-805G

Media Converter 1000BASE-T



mini-GBIC

Prima di cominciare

La Guida di Installazione Rapida fornisce le istruzioni passo - passo per configurare il Media Converter D-Link DMC-805G da 1000BASE-T a mini-GBIC. Per maggiori informazioni sul media converter, i suoi componenti, sulle connessioni di rete e sulle specifiche tecniche, fare riferimento al Manuale Utente incluso con il proprio media converter.

Contenuto del pacchetto

Il dispositivo DMC-805G viene fornito con i seguenti componenti :



- Media Converter DMC-805G1000BASE-T e mini-GBIC

- Manuale Utente

1 Setup del Media Converter DMC-805G

Come qualsiasi dispositivo elettrico, è necessario posizionare il prodotto in questione dove non siano presente temperatura elevata, umidità o interferenze elettromagnetiche. In particolare, installare il prodotto in un luogo dove siano rispettati i seguenti requisiti ambientali:

- A. La temperatura ambiente deve essere compresa tra i 32 e 104 gradi Fahrenheit (tra 0 e 40 gradi Celsius).
- B. L'umidità relativa deve essere meno del 90 %, non-condensante.
- C. Dispositivi elettrici a diffusione non devono seguire le emissioni elettromagnetiche (RFC) dello standard IEC 801-3, Level 2 (3V/M).
- D. Assicurarsi che il dispositivo sia in luogo ben ventilato. Non chiudere le fessure di ventilazione ai lati del media converter o le fessure del ventilatore nel retro del dispositivo.
- E. La presa di corrente deve essere ad almeno 1.8 metri dal dispositivo.

2 Connessione dell'alimentazione

1. Questo converter è un dispositivo plug-and-play.
2. Connettere la spina del trasformatore AC/DC con voltaggio di 7.5Vdc/1.5Amp nel connettore alimentazione sul pannello posteriore del media converter, e poi connettere l'altro capo ad una presa di corrente AC con un voltaggio compreso tra 00 e 260 Vac.

3 Interruttori a scorrimento

Per l'impostazione della modalità duplex della porta in fibra ottica, utilizzare la serie in interruttori a scorrimento. Fare

riferimento alla tabella sotto per maggiori informazioni.

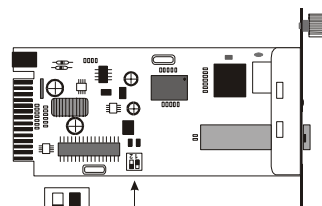

Switch 1 : On -> Forced Mode
 Off -> Auto Negotiation mode
 Switch 2 : On -> LLR enable
 Off -> LLR disable

Ponticello 1	On	Fibra Modalità forza
	Off	Fibra Negoziazione
Ponticello 2	On	LLR Abilitato
	Off	LLR Disabilitato

4 Installazione in Chassis

Il media converter può essere inserito in uno slot di espansione di uno speciale chassis.

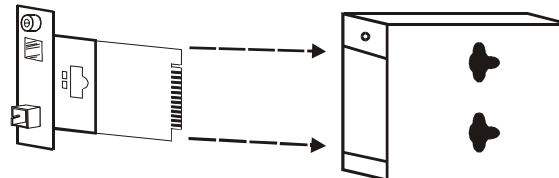

Svitare e togliere la scheda del media converter

• **Primo, installare il media converter nello slot dello chassis:**

Fase 1- Togliere la copertura dello slot desiderato dallo chassis.

Fase 2- Rimuovere le viti dal media converter come illustrato sotto

Fase 3- Fissare il media converter nello slot utilizzando le viti a corredo.

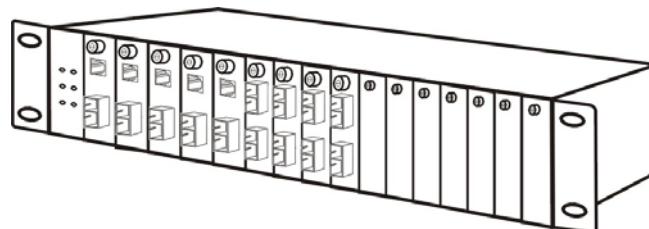

5

Indicatori LED

Gli indicatori LED mostrano lo stato di funzionamento del media converter:

LED	Stato	Indicazione
Alimentazione (PWR)	Luce Accesa	Acceso
	Luce Spenta	Spento
LINK/ACT	Luce Accesa	Collegato
	Lampeggiante	Trasmissione/ricezione dati
	Luce Spenta	Non Collegato

Supporto tecnico

Le ultime versioni del software e la documentazione aggiornata sono disponibili al sito D-Link.

D-Link fornisce supporto tecnico a tutti i clienti italiani per tutti i prodotti del prodotto. I clienti italiani possono trovare il supporto tecnico al sito **D-Link** Building Networks for People. © D-Link

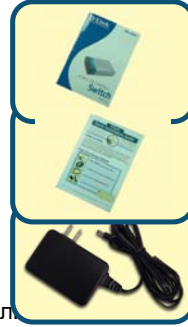

Если что-либо из перечисленного отсутствует, обратитесь к вашему поставщику.

©2004 D-Link Systems, Inc. All rights reserved. Trademarks or registered trademarks are the property of their respective holders. Software and specifications subject to change without notice.

D-Link Quick Installation Guide

DMC-805G

Управляемый медиаконвертор
1000BASE-T на mini-GBIC



Перед тем как начать

Руководство по быстрой установке дает пошаговые инструкции для установки медиаконвертора DMC-805G 1000BASE-T на mini-GBIC. Модель, которую Вы приобрели может незначительно отличаться от показанных на иллюстрациях. За более подробной информацией о медиаконверторе, его компонентах, подключении к сети и технических спецификациях, обратитесь, пожалуйста, к руководству пользователя, включенному в комплект поставки.

Проверьте содержимое комплекта

Эти элементы входят в комплект поставки DMC-805G:



- Медиаконвертор DMC-805G 1000BASE-T на mini-GBIC

- Руководство пользователя

1

Установка медиаконвертора DMC-805G

Как и любое другое электрическое устройство, Вы должны поместить оборудование там, где это не будет подвергнуто высоким температурам, влажности, или электромагнитным помехам. Место, которое Вы выберете, должно удовлетворять следующим требованиям:

- A.** Окружающая температура должна быть между 0° и 40° C.
- B.** Относительная влажность меньше, чем 90% , без конденсата.
- C.** Окружающие электрические приборы должны соответствовать стандарту IEC 801-3 (электромагнитные поля) и Level 2 (З/М) (сила электромагнитного поля)
- D.** Убедитесь, что место, где установлено устройство имеет хорошую вентиляцию. Не блокируйте вентиляционные отверстия на каждой стороне медиаконвертора, или же на задней панели оборудования.
- E.** Электрическая розетка должна находиться не ближе 1.8 метра от медиаконвертора.

2

Подключение питания

1. Данный медиаконвертор является устройством plug-and-play.
2. Подключите адаптер питания 7.5 В/1.5А, входящий в комплект к разъему питания на задней панели медиаконвертора, затем включите его в стандартную электрическую розетку.

3

Переключатель на медиаконверторе

На плате медиаконвертора имеется переключатель для установки дуплексного режима для оптического

порта. Ниже приведена таблица с подробными установками.

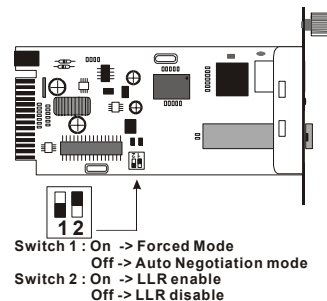

Переключатель 1	On	Фиксированный режим для оптического порта
	Off	Автопереговоры для оптического порта
Переключатель 2	On	LLR активно
	Off	LLR отключено

4

Установка в шасси

Медиаконвертор может быть установлен в слот расширения специально разработанного шасси.

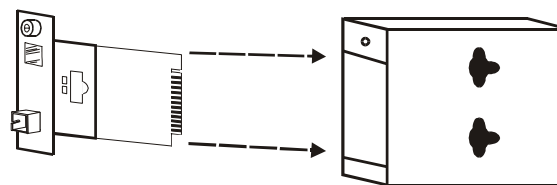

Снимите корпус медиаконвертора

- Сначала установите медиаконвертор в шасси:

Шаг 1- Открутите шуруп и снимете фальш-панель с нужного слота расширения.

Шаг 2- Удалите шуруп на медиаконвертере, как показано ниже.

Шаг 3- Установите медиаконвертер в шасси и закрепите его.

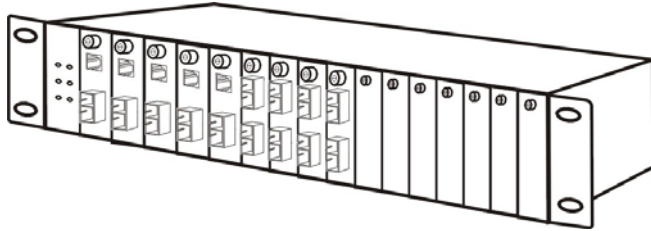

M

5

Индикаторы

Индикаторы позволяют отслеживать состояние медиаконвертера:

ЬМВО ОГИКВСТ

Индикатор	Состояние	Описание
Питание (PWR)	Горит	Питание включено
	Не горит	Питание выключено
LINK/ACT	Горит	Связь есть
	Мигает	Передача данных
	Не горит	Связи нет

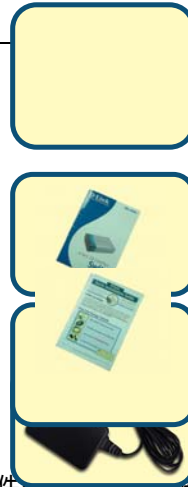

如以上物件有任何缺欠,請與經銷商聯繫。

©2004版權所有。D-Link與D-Link商標為友訊科技的商標,其他註冊商標分別隸屬該公司所有。最新規格以原廠通告為準,恕不另行通知。

D-Link Quick Installation Guide

DMC-805G



1000BASE-T 到mini-GBIC

開始前

本快速安裝手冊為安裝D-Link **DMC-805G** 1000BASE-T轉mini-GBIC介質轉換器提供步驟性指導。您購買的產品可能與插圖中所示的產品稍微不一樣。想獲取關於此介質轉換器的部件,網路連接,和技術規格的詳細資訊,請閱所附的使用手冊。

檢查包裝內容

用戶購買的 DMC-805G應包括以下部件:



- DMC-805G 1000BASE-T 到 mini-GBIC介質轉換器

1

安裝DMC-805G

光纖介質轉換器

對於任何一台電器設備,您都應將該設備放在不受較高溫度,潮濕,或電磁影響的地方。特別是選擇的地方應符合以下要求:

- A. 周圍的溫度應在華氏溫度32 和 104 度之間, (攝氏0 到 40度).
- B. 相對濕度應低於百分之九十,非凝結.
- C. 周圍的電器設備不應超過IEC 801□3, 2 (3V/M)磁場強度等級的電磁場(RFC)標準.
- D. 保證設備通風良好。
不要阻塞介質轉換器每邊的通風孔或一邊的風扇排氣口,或設備背面上的風扇排氣口,
- E. 電源插座應在交換器1.8米內.

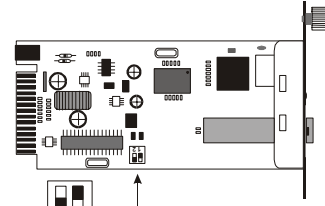

Switch 1 : On -> Forced Mode
Off -> Auto Negotiation mode
Switch 2 : On -> LLR enable
Off -> LLR disable

Switch 1	On	Fiber Forced Mode
	Off	Fiber Auto-Negotiation
Switch 2	On	LLR Enable
	Off	LLR Disable

2

連接電源

1. 該轉換器是即插即用設備.
2. 將7.5Vdc/1.5Amp電源電壓的AC到DC電源供應器連接到轉換器后面板的插座上。
然後再把插頭插進100 t到260 Vac電壓範圍內的標準AC插座中.

3

滑動式開關

光纖埠具備有滑動式開關可用於設定半/全雙工模式。詳細資訊請參看下列圖表。

4

安裝在機箱中

LED指示燈	狀態	表示
電源 (PWR)	亮	電源供應中
	滅	停止運作
LINK/ACT	亮	連線中
	閃爍	傳輸或接收資料
	滅	沒有連線

LED指示燈

LED指示燈即時為用戶提供關於轉換器狀態的回饋資訊:



此轉換器可以安裝在經過特別設計的機箱上的任何一個擴充槽中。

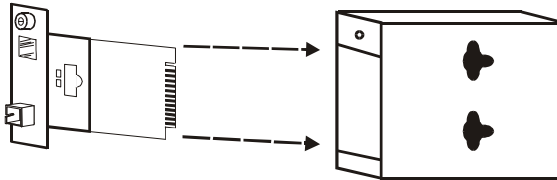

旋出螺絲, 拔出介質轉換器檔板

• 首先, 將該轉換器安裝在由機箱所提供的架座上:

步驟 1-

從機箱上欲安裝的擴充槽處旋開架座的螺絲

步驟2-按圖所示旋下轉換器上的螺絲

步驟 3-

將轉換器安裝在架座上, 使用螺絲將其固定.

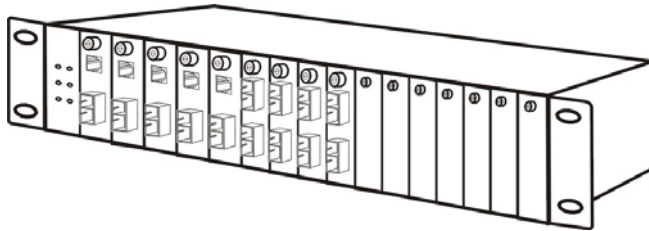

5

Free Manuals Download Website

<http://myh66.com>

<http://usermanuals.us>

<http://www.somanuals.com>

<http://www.4manuals.cc>

<http://www.manual-lib.com>

<http://www.404manual.com>

<http://www.luxmanual.com>

<http://aubethermostatmanual.com>

Golf course search by state

<http://golfingnear.com>

Email search by domain

<http://emailbydomain.com>

Auto manuals search

<http://auto.somanuals.com>

TV manuals search

<http://tv.somanuals.com>