

MODEL

DCM24

followed by letter indicating color

**S=Stainless steel,
B=Black,
R=Arctic white**

Convection Microwave Oven

MICROWAVE OVEN USE & CARE MANUAL

CONTENTS

- For Customer Assistance
..... Inside Front Cover
- Precautions to Avoid Possible
Exposure to Excessive Microwave
Energy Inside Front Cover
- Product Warranty 1
- Important Safety Instructions 2
- Installation Instructions 3
- Grounding Instructions 4
- Information You Need to Know 5
- Part Names 8
- Before Operating 11
- Manual Operation 11
- Special Features 16
- Other Convenient Features 23
- Cleaning and Care 25
- Service Call Check 26
- Specifications 26
- Guia Panel de Control 27
- Control Panel Guide 28,29

Read all instructions carefully before using your oven.

FOR CUSTOMER ASSISTANCE

To aid in reporting this microwave oven in case of loss or theft, please record below the model number and serial number located on the unit. We also suggest you record all the information listed and retain for future reference.

MODEL NUMBER _____	SERIAL NUMBER _____
DATE OF PURCHASE _____	
Dealer _____	Telephone _____
Service _____	Telephone _____

TO PHONE: (800)793-0093

TO WRITE: DACOR
1440 Bridge Gate Drive
Diamond Bar, CA 91765

Please provide the following information when you write or call: model number, serial number, date of purchase, your complete mailing address (including zip code), your daytime telephone number (including area code) and description of the problem.

TO ACCESS INTERNET: www.dacor.com

PRECAUTIONS TO AVOID POSSIBLE EXPOSURE TO EXCESSIVE MICROWAVE ENERGY

- (a) Do not attempt to operate this oven with the door open since open-door operation can result in harmful exposure to microwave energy. It is important not to defeat or tamper with the safety interlocks.
- (b) Do not place any object between the oven front face and the door or allow soil or cleaner residue to accumulate on sealing surfaces.
- (c) Do not operate the oven if it is damaged. It is particularly important that the oven door close properly and that there is no damage to the: (1) door (bent), (2) hinges and latches (broken or loosened), (3) door seals and sealing surfaces.
- (d) The oven should not be adjusted or repaired by anyone except properly qualified service personnel.

PRODUCT WARRANTY

WHAT IS COVERED

CERTIFICATE OF WARRANTIES

DACOR MICROWAVE OVEN

WITHIN THE FIFTY STATES OF THE U.S.A., THE DISTRICT OF COLUMBIA AND CANADA * :

FULL ONE YEAR WARRANTY

If your DACOR product fails to function within one year of the original date of purchase, due to a defect in material or workmanship, DACOR will remedy the defect without charge to you or subsequent users. The owner must provide proof of purchase upon request and have the appliance accessible for service.

* Warranty is null and void if non-CSA approved product is transported from the U.S.

OUTSIDE THE FIFTY STATES OF THE U.S.A., THE DISTRICT OF COLUMBIA AND CANADA:

LIMITED FIRST YEAR WARRANTY

If your DACOR product fails to function within one year of the original date of purchase, due to a defect in material or workmanship, DACOR will furnish a new part, F.O.B. factory, to replace the defective part. All delivery, installation and labor costs are the responsibility of the purchaser. The owner must provide proof of purchase upon request and have the appliance accessible for service.

WHAT IS NOT COVERED

- Failure of the product caused by faulty installation, improper usage, or neglect of required maintenance.
- Service calls to educate the customer in the proper use and care of the product.
- Failure of the product when used for commercial, business, rental or any application other than for residential consumer use.
- Replacement of house fuses or fuse boxes, or resetting of circuit breakers.
- Damage to the product caused by accident, fire, flood or other acts of God.
- Breakage, discoloration or damage to glass, metal surfaces, plastic components, trim, paint, porcelain or other cosmetic finish, caused by improper usage or care, abuse, or neglect.

THE REMEDIES PROVIDED FOR IN THE ABOVE EXPRESS WARRANTIES ARE THE SOLE AND EXCLUSIVE REMEDIES THEREFORE NO OTHER EXPRESS WARRANTIES ARE MADE, AND OUTSIDE THE FIFTY STATES OF THE UNITED STATES AND THE DISTRICT OF COLUMBIA, ALL IMPLIED WARRANTIES, INCLUDING BUT NOT LIMITED TO , ANY IMPLIED WARRANTY OF MERCHANTABILITY OR FITNESS FOR A PURCHASE. IN NO EVENT SHALL DACOR BE LIABLE FOR INCIDENTAL EXPENSE OR CONSEQUENTIAL DAMAGES NO WARRANTIES, EXPRESS OR IMPLIED, ARE MADE TO ANY BUYER FOR RESALE.

Some states do not allow limitations on how long an implied warranty lasts or do not allow the exclusion or limitation of incidental or consequential damages, so the above limitations or exclusions may not apply to you. This warranty gives you specific legal rights, and you may also have other rights that vary from state to state.

IMPORTANT SAFETY INSTRUCTIONS

When using electrical appliances basic safety precautions should be followed, including the following:

WARNING - To reduce the risk of burns, electric shock, fire, injury to persons or exposure to excessive microwave energy:

1. **Read all instructions before using the appliance.**
2. Read and follow the specific **“PRECAUTIONS TO AVOID POSSIBLE EXPOSURE TO EXCESSIVE MICROWAVE ENERGY”** on inside front cover.
3. This appliance must be grounded. Connect only to properly grounded outlet. See **“GROUNDING INSTRUCTIONS”** on page 4.
4. Install or locate this appliance only in accordance with the provided installation instructions.
5. Some products such as whole eggs and sealed containers -- for example, closed glass jars -- are able to explode and should not be heated in this oven.
6. Use this appliance only for its intended use as described in this manual. Do not use corrosive chemicals or vapors in this appliance. This type of oven is specifically designed to heat, cook or dry food. It is not designed for industrial or laboratory use.
7. As with any appliance, close supervision is necessary when used by children.
8. Do not operate this appliance if it has a damaged cord or plug, if it is not working properly or if it has been damaged or dropped.
9. This appliance should be serviced only by qualified service personnel. Contact nearest Dacor Authorized Servicer for examination, repair or adjustment.
10. Do not cover or block any openings on the appliance.
11. Do not store or use this appliance outdoors. Do not use this product near water--for example, near a kitchen sink, in a wet basement, near a swimming pool or similar locations.
12. Do not immerse cord or plug in water.
13. Keep cord away from heated surfaces.
14. Do not let cord hang over edge of table or counter.
15. See door surface cleaning instructions on page 25.
16. To reduce the risk of fire in the oven cavity:
 - a. Do not overcook food. Carefully attend appliance when paper, plastic or other combustible materials are placed inside the oven to facilitate cooking.
 - b. Remove wire twist-ties from paper or plastic bags before placing bag in oven.
 - c. **If materials inside the oven ignite, keep oven door closed, turn oven off and disconnect the power cord or shut off power at the fuse or circuit breaker panel.**
 - d. Do not use the cavity for storage purposes. Do not leave paper products, cooking utensils or food in the cavity when not in use.
17. Liquids, such as water, coffee or tea are able to be overheated beyond the boiling point without appearing to be boiling. Visible bubbling or boiling when the container is removed from the microwave oven is not always present. **THIS COULD RESULT IN VERY HOT LIQUIDS SUDDENLY BOILING OVER WHEN A SPOON OR OTHER UTENSIL IS INSERTED INTO THE LIQUID.** To reduce the risk of injury to persons:
 - a. Do not overheat the liquid.
 - b. Stir the liquid both before and halfway through heating it.
 - c. Do not use straight-sided containers with narrow necks. Use a wide-mouthed container.
 - d. After heating, allow the container to stand in the microwave oven at least for 20 seconds before removing the container.
 - e. Use extreme care when inserting a spoon or other utensil into the container.
18. If the oven light fails, consult a **DACOR AUTHORIZED SERVICER.**
19. Do not operate any heating or cooking appliance beneath this appliance.
20. Do not mount unit over or near any portion of a heating or cooking appliance.
21. Do not mount over a sink.
22. Do not store anything directly on top of the appliance surface when the appliance is in operation.
23. DCM24 is suitable for built-in installation over only Dacor's wall oven and warming oven models. See page 3 for applicable models.

SAVE THESE INSTRUCTIONS

INSTALLATION INSTRUCTIONS

Unpacking and Examining Your Oven

Remove all packing materials from inside the oven cavity; however, **DO NOT REMOVE THE WAVEGUIDE COVER**, which is located on the ceiling.

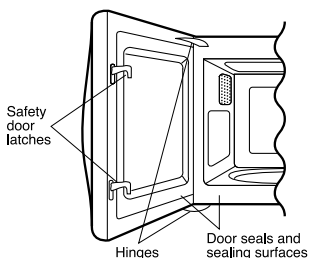

ing. Read enclosures and **SAVE** the Operation Manual. Check the oven for any damage, such as misaligned or bent door, damaged door seals and sealing surfaces, broken or loose door hinges and latches and dents inside the cavity or on the door. If there is any damage, do not operate the oven and contact your dealer or **DACOR AUTHORIZED SERVICER**.

Choosing a Location for Your Oven on the counter

You will use the oven frequently so plan its location for ease of use. It's wise, if possible, to have counter space on at least one side of the oven. The oven must be placed on a counter top which is a minimum of 36 inches from the floor. Allow at least 2 inches on the sides, top and at the rear of the oven for air circulation. Be sure to position oven so that the rear cannot be touched inadvertently.

Choosing a Location for Your Oven if built-in

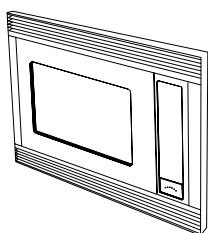

Your oven can be built into a cabinet or wall by itself or above any DACOR wall oven listed below using DACOR's Built-in Kits, either the ACTK27 or the ACTK30. The ACTK27 is for a 27" wall oven, while the ACTK30 accommodates installation above 30" wall ovens.

The applicable wall ovens and warming ovens are as follows:

OVENS - ECS127, ECS130, MCS127, MCS130, PCS127, PCS130

WARMING OVENS - EWO24, EWO27, EWO30, MWO27, MWO30, PWO24, PWO27, PWO30, IWO24, IWO27

Do not built-in above any other gas or electric wall oven.

ABOVE OVEN INSTALLATION

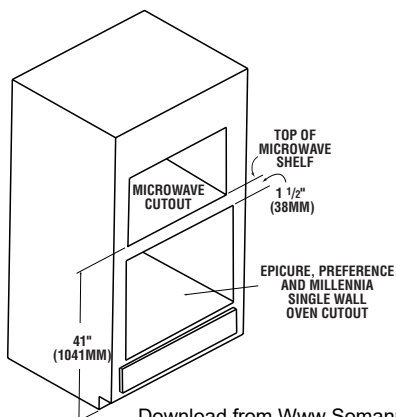

ABOVE WARMING OVEN INSTALLATION

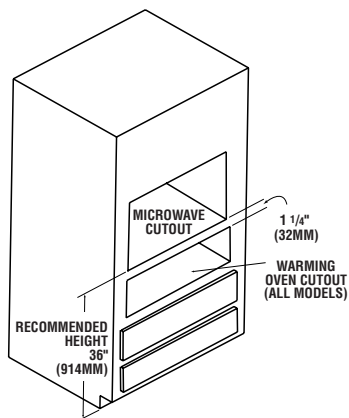

Carefully follow both the wall oven installation instructions and Built-in Kit instructions.

The opening in the wall or cabinet must be the following dimensions:

- A HEIGHT** : 19 1/8 "
- B WIDTH** : 25 1/4 " (ACTK27)
28 1/4 " (ACTK30)
- C DEPTH** : 24 "

The electrical outlet should NOT be in the shaded area as indicated.

The floor of the opening should be constructed of plywood strong enough to support the weight of the oven and floor load (about 100 pounds). The floor should be level for proper operation of the oven. Be sure to check the local building code as it may require that the opening be enclosed with sides, ceiling and rear partition. The proper functioning of the oven does not require the enclosure.

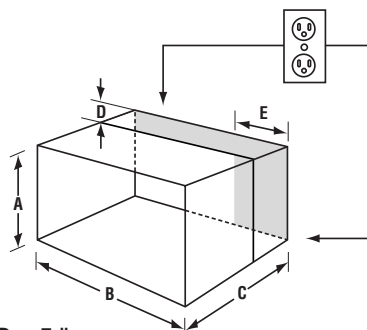

- D** : 5 "
- E** : 10" (ACTK27)
: 11 1/2" (ACTK30)

Call toll-free: (800) 793-0093 for a dealer nearest you. The kit includes ducts, finish trim strips and easy-to-follow instructions for installation as well as the location of the power supply.

GROUNDING INSTRUCTIONS

This appliance must be grounded. This oven is equipped with a cord having a grounding wire with a grounding plug. It must be plugged into a wall receptacle that is properly installed and grounded in accordance with the National Electrical Code and local codes and ordinances. In the event of an electrical short circuit, grounding reduces the risk of electric shock by providing an escape wire for the electric current.

WARNING – Improper use of the grounding plug can result in a risk of electric shock.

Electrical Requirements

The electrical requirements are a 120 volt 60 Hz, AC only, 15 amp. or more protected electrical supply. It is recommended that a separate circuit serving only the microwave oven be provided.

The oven is equipped with a 3-prong grounding plug. It must be plugged into a wall receptacle that is properly installed and grounded. Should you only have a 2-prong outlet, have a qualified electrician install a correct wall receptacle.

A 3-prong adapter may be purchased and used temporarily if local codes allow. Follow package directions.

A short power-supply cord is provided to reduce risk of becoming entangled in or tripping over a longer cord.

Extension Cord

If it is necessary to use an extension cord, use only a 3-wire extension cord that has a 3-blade grounding plug and a 3-slot receptacle that will accept the plug on the microwave oven. The marked rating of the extension cord should be AC 115-120 volt, 15 amp. or more.

Be careful not to drape the cord over the countertop or table where it can be pulled on by children or tripped over accidentally.

Notes:

1. If you have any questions about the grounding or electrical instructions, consult a qualified electrician or service person.
2. Neither Dacor nor the dealer can accept any liability for damage to the oven or personal injury resulting from failure to observe the correct electrical connection procedures.

Radio or TV Interference

Should there be any interference caused by the microwave oven to your radio or TV, check that the microwave oven is on a different electrical circuit, relocate the radio or TV as far away from the oven as feasible or check position and signal of receiving antenna.

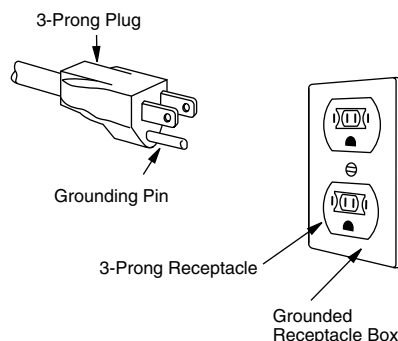

Permanent and Correct Installation

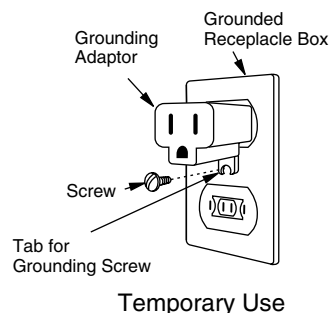

INFORMATION YOU NEED TO KNOW

About Your Oven

This Use & Care Manual is valuable: read it carefully and always save it for reference.

The Dacor Convection Microwave Cookbook is a valuable asset. Check it frequently for cooking principles, techniques, hints and recipes.

NEVER use the oven without the turntable and support nor turn the turntable over so that a large dish could be placed in the oven. The turntable will turn both clockwise and counterclockwise.

ALWAYS have food in the oven when it is on to absorb the microwave energy.

When using the oven at power levels below 100%, you may hear the magnetron cycling on and off. It is normal for the exterior of the oven to be warm to the touch when cooking or reheating.

Condensation is a normal part of microwave cooking. Room humidity and the moisture in food will influence the amount of moisture that condenses in the oven.

Generally, covered foods will not cause as much condensation as uncovered ones. Vents on the oven back must not be blocked.

After using **convection, automatic mix or broil**, you will hear the sound of the cooling fan. The fan may continue to operate as long as 5 minutes, depending on the oven temperature.

Be aware that, unlike microwave-only ovens, convection microwave ovens have a tendency to become hot during **convection, automatic mix and broil** cooking.

The oven is for food preparation only. It should not be used to dry clothes or newspapers.

Your oven is rated 900 watts using the IEC Test Procedure. In using recipes or package directions, check food at the minimum time and add time accordingly.

About Food

	DO	DON'T
Eggs, sausages, nuts, seeds, fruits & vegetables	<ul style="list-style-type: none"> * Puncture egg yolks before cooking to prevent "explosion". * Pierce skins of potatoes, apples, squash, hot dogs and sausages so that steam escapes. 	<ul style="list-style-type: none"> * Cook eggs in shells. * Reheat whole eggs. * Dry nuts or seeds in shells.
Popcorn	<ul style="list-style-type: none"> * Use specially bagged popcorn for the microwave oven. * Listen while popping corn for the popping to slow to 1 or 2 seconds or use POPCORN pad for "no-guess" popping. * Use an overturned 9 or 10 inch oven proof glass pie plate on top of the turntable when popping bagged microwave popcorn. 	<ul style="list-style-type: none"> * Pop popcorn in regular brown bags or glass bowls. * Exceed maximum time on popcorn package.
Baby food	<ul style="list-style-type: none"> * Transfer baby food to small dish and heat carefully, stirring often. Check temperature before serving. * Put nipples on bottles after heating and shake thoroughly. "Wrist" test before feeding. 	<ul style="list-style-type: none"> * Heat baby food in original jars. * Heat disposable bottles. * Heat bottles with nipples on.
General	<ul style="list-style-type: none"> * Cut baked goods with filling after heating to release steam and avoid burns. * Stir liquid briskly before and after heating to avoid "eruption". * Use deep bowl when cooking liquid or cereal to prevent boilovers. 	<ul style="list-style-type: none"> * Heat or cook in closed glass jars or air tight containers. * Can in the microwave as harmful bacteria may not be destroyed. * Deep fat fry. * Dry wood, gourds, herbs or wet papers.

About Utensils and Coverings

It is not necessary to buy all new cookware. Many pieces already in your kitchen can be used successfully in your new convection microwave oven. The chart below will help you decide what utensils and coverings should be used in each mode.

Utensils and Coverings	Microwave Only	Convection Broil, Slow Cook	High Mix/Roast Low Mix/Bake
Aluminum foil	Yes Small flat pieces of aluminum foil placed smoothly on food can be used to shield areas from cooking or defrosting too quickly. Keep foil at least 1 inch from walls of oven.	Yes For shielding	Yes For shielding
Aluminum containers	Yes Can be used if 3/4 filled with food. Keep 1 inch away from walls and do not cover with foil.	Yes Broil-No cover	Yes Can be used if 3/4 filled with food. Keep 1 inch away from walls and do not cover with foil.
Browning dish	Yes Do not exceed recommended preheating time. Follow manufacturer's directions.	No	No
Glass ceramic (Pyroceram.®)	Yes Excellent	Yes Excellent	Yes Excellent
Glass, heat-resistant	Yes Excellent. Overturned pie plate necessary for popping popcorn.	Yes Excellent	Yes Excellent
Glass, non-heat-resistant	No	No	No
Lids, glass	Yes	Yes Broil-No cover	Yes
Lids, metal	No	Yes Broil-No cover	No
Metal cookware	No	Yes	Yes Do not use metal covering.
Metal, misc: dishes with metallic trim, screws, bands, handles. Metal twist ties	No	No	No
Oven cooking bags	Yes Good for large meats or foods that need tenderizing. DO NOT use metal twist ties.	Yes Broil-No	Yes DO NOT use metal twist ties.
Paper plates	Yes For reheating	No	No
Paper towels	Yes To cover for reheating and cooking. Do not use recycled paper towels which may contain metal fillings.	No	No
Paper, ovenable	Yes	Yes For temperatures up to 400°F. Do not use for broiling.	Yes For temperatures up to 400°F.

Utensils and Coverings	Microwave Only	Convection Broil, Slow Cook	High Mix/Roast Low Mix/Bake
Microwave-safe plastic containers	Yes Use for reheating and defrosting. Some microwave-safe plastics are not suitable for cooking foods with high fat and sugar content. Follow manufacturer's directions.	No	No
Plastic, Thermoset®	Yes	Yes Are heat resistant up to 425°F. Do not use for broiling.	Yes
Plastic wrap	Yes Use brands specially marked for microwave use. DO NOT allow plastic wrap to touch food. Vent so steam can escape.	No	No
Pottery, porcelain stoneware	Yes Check manufacturer's recommendation for being microwave safe.	Yes	Yes Must be microwave safe and ovenable.
Styrofoam	Yes For reheating	No	No
Wax paper	Yes Good covering for cooking and reheating	No	No
Wicker, wood, straw	Yes May be used for short periods of time. Do not use with high fat or high sugar content foods. Could char.	No	No

DISH CHECK. If you wish to check if a dish is safe for microwaving, place the empty dish in the oven and microwave on HIGH for 30 seconds. If the dish becomes very hot, do NOT use it for microwaving.

ACCESSORIES There are many microwave accessories available for purchase. Evaluate carefully before you purchase so that they meet your needs. A microwave-safe thermometer will assist you in determining correct doneness and assure you that foods have been cooked to safe temperatures when using microwave-only cooking. Dacor is not responsible for any damage to the oven when accessories are used.

About Microwave Cooking

- * Arrange food carefully. Place thickest areas toward outside of dish.
- * Watch cooking time. Cook for the shortest amount of time indicated and add more as needed. Foods severely overcooked can smoke or ignite.
- * Cover foods while cooking. Check recipe or cookbook for suggestions: paper towels, wax paper, microwave plastic wrap or a lid. Covers prevent spattering and help foods to cook evenly.
- * Shield with small flat pieces of aluminum foil any thin areas of meat or poultry to prevent overcooking before dense, thick areas are cooked thoroughly.
- * Stir foods from outside to center of dish once or twice during cooking, if possible.
- * Turn foods over once during microwaving to speed cooking of such foods as chicken and hamburgers. Large items like roasts or turkey breasts must be turned over at least once.
- * Rearrange foods like meatballs halfway through cooking both from top to bottom and from the center of the dish to the outside.
- * Add standing time. Remove food from oven and stir, if possible. Cover for standing time which allows the food to finish cooking without overcooking.
- * Check for doneness. Look for signs indicating that cooking temperatures have been reached.

Doneness signs include:

 - Food steams throughout, not just at edge.
 - Center bottom of dish is very hot to the touch.
 - Poultry thigh joints move easily.
 - Meat and poultry show no pinkness.
 - Fish is opaque and flakes easily with a fork.

About Children and the Microwave

Children below the age of 7 should use the microwave oven with a supervising person very near to them. Between the ages of 7 and 12, the supervising person should be in the same room.

The child must be able to reach the oven comfortably; if not, he/she should stand on a sturdy stool.

At no time should anyone be allowed to lean or swing on the oven door.

Children should be taught all safety precautions: use potholders, remove coverings carefully, pay special attention to packages that crisp food because they may be extra hot.

Don't assume that because a child has mastered one cooking skill he/she can cook everything.

Children need to learn that the microwave oven is not a toy. See page 24 for Safety Lock feature.

About Safety

* Check foods to see that they are cooked to the United States Department of Agriculture's recommended temperatures:

- 160°F. for fresh pork, boneless white poultry, fish, seafood, egg dishes and frozen prepared food.
- 165°F. for leftover, ready-to-heat refrigerated, and deli and carry-out "fresh" food.
- 170°F. white meat of poultry.
- 180°F. dark meat of poultry.

To test for doneness, insert a meat thermometer in a thick or dense area away from fat or bone. NEVER leave the thermometer in food during cooking, unless using a microwave thermometer when cooking with only microwave power.

* Always use potholders to prevent burns when handling utensils that are in contact with hot food.

Enough heat from the food can transfer through utensils to cause skin burns.

* Avoid steam burns by directing steam away from the face and hands. Slowly lift the farthest edge of a dish's covering and carefully open popcorn and oven cooking bags away from the face.

* Stay near the oven while it's in use and check cooking progress frequently so that there is no chance of overcooking food.

* NEVER use the cavity for storing cookbooks or other items.

* Select, store and handle food carefully to preserve its high quality and minimize the spread of foodborne bacteria.

* Keep wave guide cover clean. Food residue can cause arcing and/or fires.

* Keep aluminum foil used for shielding at least 1 inch away from walls, ceiling and door.

* Use potholders and be careful when using convection, mix or broil cooking as cabinet, interior and door may be too hot to touch.

* Use care when removing items from the oven so that the utensil, your clothes or accessories do not touch the safety door latches.

PART NAMES

- ① Ventilation openings. (Rear side)
- ② Oven door with see-through window.
- ③ Oven light.

It will light when the door is opened or when oven is in operation.

- ④ Turntable support. (See page 9)
- ⑤ Removable turntable. (See page 9)

The turntable will rotate clockwise or counterclockwise.

- ⑥ Safety door latches.

The oven will not operate unless the door is securely closed.

- ⑦ Waveguide cover.
- ⑧ Door open button.
- ⑨ Auto-Touch control panel.
- ⑩ Lighted digital display.
- ⑪ Convection air openings.
- ⑫ Removable low rack. (Broiling trivet)
- ⑬ Removable high rack. (Baking rack)
- ⑭ Turntable motor shaft.

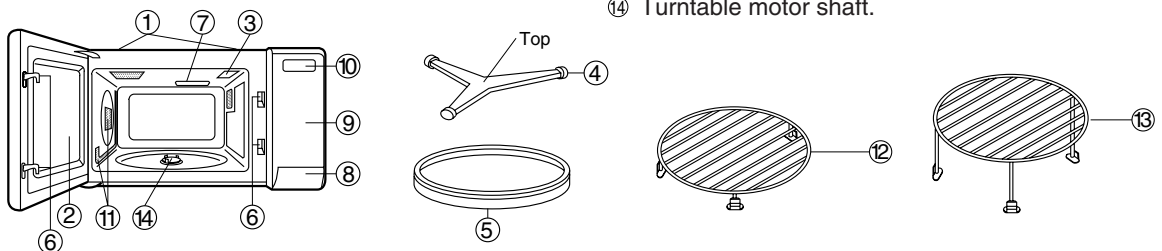

Special Note for the Turntable Support and Turntable

Read carefully before setting the turntable and turntable support, to turn them smoothly. Improper setting may cause arcing.

1. Place the turntable support to the turntable motor shaft, "Top" side up (Top is engraved on one side). See Fig.1-1 and Fig.1-2. And make sure the center of turntable support is set between three nails of the turntable motor shaft as shown in Fig.2.

Fig.1-1 Turntable support

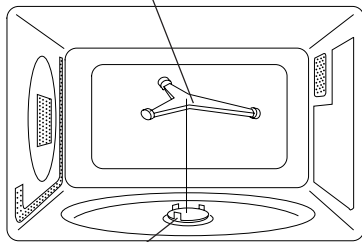

Turntable motor shaft

Fig.1-2

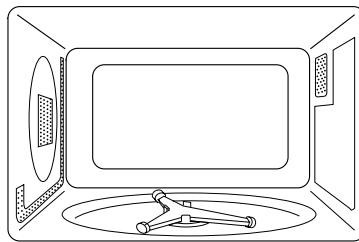

The nails of the turntable motor shaft

Fig. 2 Turntable support

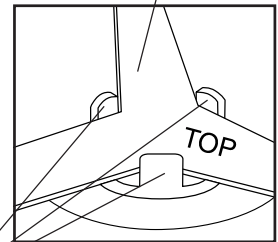

2. Place the turntable on the turntable support. The turntable should be set as all three rollers of turntable support contact to the flat surface of the turntable. Check the position of the turntable and turntable support, referring to the chart below, and make sure the turntable rotates smoothly.

	CORRECT	WRONG
Back view	<p>Flat surface of the turntable</p> <p>Roller of the turntable support</p>	<p>Flat surface of the turntable</p> <p>Out of flat surface</p>
Side view	<p>Flat surface of the turntable</p> <p>Roller of the turntable support</p>	<p>Flat surface of the turntable</p> <p>Roller of the turntable support</p>

PART NAMES

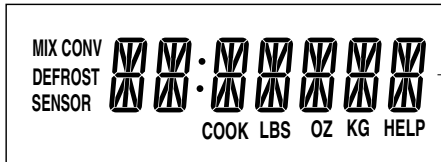

Interactive display
Words will light in the display to indicate features and cooking instructions.

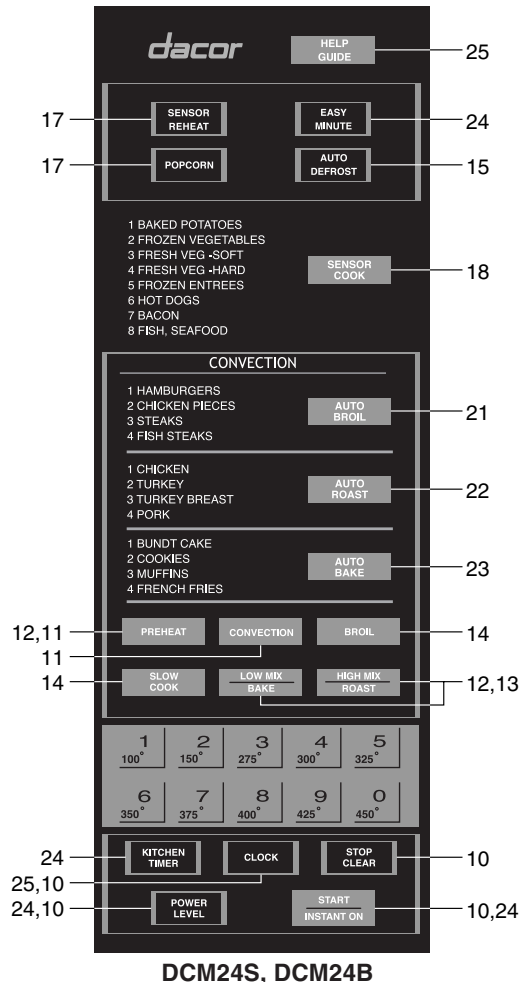
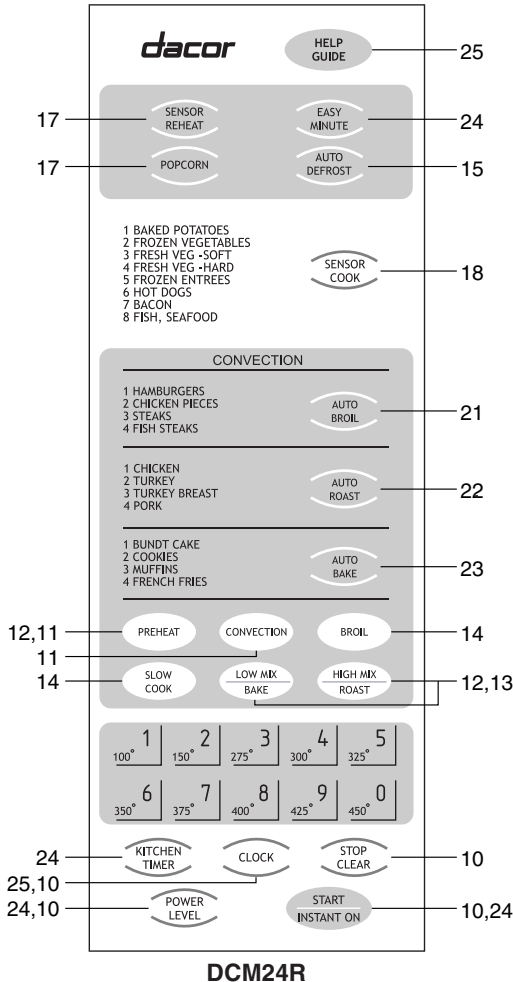

Numbers indicate pages on which there are a feature description and usage information.

ACCESSORIES

The following accessories are designed especially for use in this oven only for convection, mix or broil cooking. **DO NOT USE FOR MICROWAVE ONLY COOKING.** Do not substitute similar types of racks for these specially designed ones.

High rack (Baking rack)—for convection and low mix. —This rack is placed on the turntable for two-level cooking, such as layer cakes, muffins, etc.

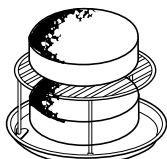

Low rack (Broiling trivet)—for convection, broiling or high mix.

—Place on the turntable and use for roasting or broiling to allow juices to drain away from food.



BEFORE OPERATING

* Before operating your new microwave oven make sure you read and understand this Use & Care manual completely.

* Before the oven can be used, follow these procedures:

- 1) Plug in the oven. Close the door. The display will say **WELCOME PRESS CLEAR AND PRESS CLOCK**.
- 2) Touch the STOP/CLEAR pad.
: will appear.
- 3) Touch CLOCK pad.
- 4) Heat the oven without food. (See page 12, SPECIAL NOTE)

TO SET THE CLOCK

* Suppose you want to enter the correct time of day 12:30 (A.M. or P.M.):

Procedure		
1.	CLOCK	Touch CLOCK pad.
2.	1 2 3 0	Enter the correct time of day by touching the numbers in sequence.
3.	CLOCK	Touch CLOCK pad again.

This is a 12 hour clock. If you attempt to enter an incorrect clock time, **ERROR** will appear in the display. Touch the STOP/CLEAR pad and re-enter the time.

* If the electrical power supply to your microwave oven should be interrupted, the display will intermittently show **WELCOME PRESS CLEAR AND PRESS CLOCK** after the power is reinstated. If this occurs during cooking, the program will be erased. The time of day will also be erased. Simply touch STOP/CLEAR pad and reset the clock for the correct time of day.

STOP/CLEAR

Touch the STOP/CLEAR pad to:

1. Erase if you make a mistake during programming.
2. Cancel kitchen timer.
3. Stop the oven temporarily during cooking.
4. Return the time of day to the display.
5. Cancel a program during cooking, touch twice.

MANUAL OPERATION

MICROWAVE COOKING

Time Cooking

Your oven can be programmed for 99 minutes 99 seconds (99.99). Always enter the seconds after the minutes, even if they are both zeros.

* Suppose you want to cook for 5 minutes at 100%:

Procedure		
1.	5 0 0	Enter cooking time.
2.	START INSTANT ON	Touch START pad.

There are eleven preset power levels. Using lower power levels increases the cooking time which is recommended for foods such as cheese, milk and long slow cooking of meats. Consult cookbook or recipes for specific recommendations.

Touch POWER LEVEL Pad Once, then Touch	Approximate Percentage of Power	Common Words for Power Levels
POWER LEVEL	100%	High
9	90%	
8	80%	Medium High
7	70%	
6	60%	
5	50%	Medium
4	40%	Med. Low/Defrost
3	30%	
2	20%	
1	10%	Low
0	0%	

* Suppose you want to defrost for 5 minutes at 30%:

Procedure		
1.	5 0 0	Enter defrosting time.
2.	POWER LEVEL 3	Enter power level.
3.	START INSTANT ON	Touch START pad.

You can program up to 4 automatic cooking sequences. Follow directions on page 23. Note that **POWER LEVEL** must be entered first when programming multiple sequences.

CONVECTION AND AUTOMATIC MIX COOKING

This section of the Use & Care Manual gives you specific cooking instructions and procedures. Please consult your Convection Microwave Cookbook for helpful hints for convection and combination cooking.

Page numbers followed by the letter c indicate the convection/mix section of the book.

The oven should not be used without the turntable in place, and it should never be restricted so that it cannot rotate. You may remove the turntable when preheating the oven and when preparing food to be cooked directly on the turntable.

Caution: The oven cabinet, cavity, door, turntable, turntable support, racks and dishes will become hot. To PREVENT BURNS, use thick oven gloves when removing the food or turntable from the oven.

Convection Cooking

During convection heating, hot air is circulated throughout the oven cavity to brown and crisp foods quickly and evenly. This oven can be programmed for ten different convection cooking temperatures for up to 99 minutes, 99 seconds.

To Cook with Convection

* Suppose you want to cook at 350°F. for 20 minutes:

Procedure		
1.	CONVECTION	Touch CONVECTION pad.
2.	6 350°	Touch temperature pad.
3.	2 0 0 0	Enter cooking time.
4.	START INSTANT ON	Touch START pad.

NOTE: If you wish to know the programmed oven temperature, simply touch the CONVECTION pad. As long as your finger is touching the CONVECTION pad, the programmed oven temperature will be displayed.

SPECIAL NOTE: You may detect smoke or a burning smell when using the convection heater for the first time, this is normal and not a sign that the oven is out of order. To avoid this problem, when first using the oven, operate the oven at 450°F without food for 20 minutes.

To Preheat and Cook with Convection

Your oven can be programmed to combine preheating and convection cooking operations. You can preheat to the same temperature as the convection temperature or change to a higher or lower temperature.

* Suppose you want to preheat to 350° F, and then cook 25 minutes at 375° F. convection:

Procedure		
1.	PREHEAT	Touch PREHEAT pad.
2.	6 350°	Select preheat temperature.
3.	CONVECTION	Touch CONVECTION pad.
4.	7 375°	Select cooking temperature.
5.	2 5 0 0	Enter cooking time.
6.	START INSTANT ON	Touch START pad.
When the oven reaches the programmed temperature, a signal will sound 4 times*. The oven will stop, and directions will be displayed. Follow the indicated message.		
7.	Open the door. Place food in the oven. Close the door.	
	START INSTANT ON	Touch START pad.

* If the oven door is not opened, the oven will automatically hold at the preheat temperature for 30 minutes. After this time has elapsed, an audible signal will sound, and the oven will turn off.

NOTE: 1. To program only preheat, touch the START pad after step 2. Preheating will start. When the oven reaches the programmed temperature, follow the indicated message.
2. To preheat and cook with the same temperature, enter same temperature in steps 2 and 4.

Automatic Mix Cooking

This oven has two pre-programmed settings that make it easy to cook with both convection heat and microwave automatically

	Oven temperature	Microwave power
HIGH MIX/ROAST	300°F	30%
LOW MIX/BAKE	350°F	10%

With the exception of those foods that cook best by convection heating alone, most foods are well suited to mix cooking using either LOW MIX/BAKE or HIGH MIX/ROAST.



The marriage of these two cooking methods produces juicy meats, moist and tender cakes and fine textured breads, all with just the right amount of browning and crispness.

The temperatures can be changed; however, the microwave power cannot.

The oven temperature can be changed from 100°F. to 450°F. To change the temperature, first touch HIGH MIX or LOW MIX, then touch the same pad again. When the display says SELECT TEMP, touch desired temperature pad. Ex: HIGH MIX, HIGH MIX pad, [7]. The mix temperature will change to 375°F automatically.

To Cook with Automatic Mix









* Suppose you want to bake a cake for 25 minutes on low mix/bake:

Procedure		
1.		Touch LOW MIX/BAKE pad.
2.		Enter cooking time.
3.		Touch START pad.

To Preheat and Cook with Automatic Mix

Your oven can be programmed to combine preheating and automatic mix cooking operations. You can preheat at the same temperature as the preset combination temperature or change it to a different temperature.

* Suppose you want to preheat to 350°F. and then cook 25 minutes on 325°F. low mix/bake:

Procedure		
1.		Touch PREHEAT pad.
2.		Select preheat temperature.
3.		Touch LOW MIX pad.
4.		Touch LOW MIX pad once more to change the cooking temperature.
5.		Select cooking temperature.
6.		Enter cooking time.
7.		Touch START pad.
When the oven reaches the programmed temperature, signal will sound 4 times*. The oven will stop and directions will be displayed. Follow the indicated message.		
8.	Open the door. Place food in the oven. Close the door.	
		Touch START pad.

* If the oven door is not opened, the oven will automatically hold at the preheat temperature for 30 minutes. After this time has elapsed, an audible signal will sound and the oven will turn off.

NOTE: To program only preheat, touch the START pad after step 2. Preheating will start. When the oven reaches the programmed temperature, follow the indicated message.

Helpful Hints for Convection and Automatic Mix Cooking

Your Dacor Convection Microwave Oven can cook any food perfectly because of the number of ways it can cook: microwave only, automatic mix, convection only or broil. The cookbook that comes with your oven has excellent instructions, guidelines, hints, charts and recipes to help you get the best use of your oven. Consult it often until you are familiar with it. This Use & Care Manual tells you how to program the oven.

The oven cannot be used without the turntable in place. Never restrict the movement of the turntable.

Convection Cooking:

1. When preheating, the turntable can be left in or removed. When using the high rack for 2 shelf baking in a preheated oven, it is easier to remove the turntable for preheat. Place high rack on turntable along with foods. When preheat is over, open oven door and quickly place turntable, high rack and foods to be baked inside.
2. Do not cover turntable, low rack or high rack with aluminum foil. It interferes with air flow that cooks food.
3. Round pizza pans are excellent cooking utensils for many convection-only items. Choose pans that do not have extended handles.
4. Using a preheated low rack can give a grilled appearance to steaks, hot dogs etc.

Automatic Mix Cooking:

1. Meats are best when roasted directly on the low rack. A dish can be placed below the meat if gravy is to be made from the drippings.
2. Less tender cuts of meat can be roasted and tenderized using oven cooking bags.
3. When baking, check for doneness after time has elapsed. If not completely done, let stand in oven a few minutes to complete cooking.

NOTE:

During mix baking some metal baking utensils may cause arcing when they come in contact with the turntable, oven walls or accessory racks. Arcing is a discharge of electricity that occurs when microwaves come in contact with metal.

If arcing occurs, place a heat resistant dish (Pyrex® pie plate, glass pizza dish or dinner plate) between the pan and the turntable or rack. If arcing occurs with other metal baking utensils, discontinue their use for mix cooking.

BROIL COOKING

Preheating is automatic when the BROIL setting is used. Only actual cooking time is entered; the oven signals when it is preheated to 450°F. Oven temperature cannot be changed. Use BROIL setting for steaks, chops, chicken pieces and many other foods. See Convection Broiling Chart in cookbook.

* Suppose you want to broil a steak for 15 minutes:

Procedure	
1.	<div style="display: flex; align-items: center; gap: 10px;"> <div style="border: 1px solid black; padding: 5px; text-align: center;">BROIL</div> <div>Touch BROIL pad.</div> </div>
2.	<div style="display: flex; align-items: center; gap: 10px;"> <div style="display: flex; gap: 5px;"> <div style="border: 1px solid black; padding: 2px 5px;">1</div> <div style="border: 1px solid black; padding: 2px 5px;">5</div> <div style="border: 1px solid black; padding: 2px 5px;">○</div> <div style="border: 1px solid black; padding: 2px 5px;">○</div> </div> <div>Enter cooking time.</div> </div>
3.	<div style="display: flex; align-items: center; gap: 10px;"> <div style="border: 1px solid black; padding: 5px; text-align: center;"> START <hr style="width: 80%; margin: 0 auto;"/> INSTANT ON </div> <div>Touch START pad. No food in oven.</div> </div>
When the oven reaches the programmed temperature, a signal will sound 4 times*.	
4.	<div style="display: flex; align-items: center; gap: 10px;"> <div>Open the door. Place food in oven. Close the door.</div> <div style="border: 1px solid black; padding: 5px; text-align: center;"> START <hr style="width: 80%; margin: 0 auto;"/> INSTANT ON </div> <div>Touch START pad.</div> </div>

* If the oven door is not opened, the oven will automatically hold at the preheat temperature for 30 minutes. After this time has elapsed, an audible signal will sound and the oven will turn off.

- NOTE:
1. Preheating for broil may take from 7 to 10 minutes depending on temperature of room and available power.
 2. Although time is usually set for the maximum broiling time, always check food at the minimum time recommended in the chart of cookbook. This will eliminate the need to completely reprogram the oven if additional cooking time is needed. Simply close the oven door and touch START to continue.
 3. Should you need more broiling time, reprogram within 1 minute of the end to eliminate preheating.

Caution: The oven cabinet, cavity, door, turntable, turntable support, racks and dishes will become hot. To PREVENT BURNS, use thick oven gloves when removing the food or turntable from the oven.

SLOW COOK

Slow Cook is preset at 300°F for 4 hours. The temperature can be changed to below 300°F. The cooking time cannot be changed. This feature can be used for foods such as baked beans or marinated chuck steak.

* Suppose you want to change oven temperature from 300°F to 275°F:

Procedure	
1.	<div style="display: flex; align-items: center; gap: 10px;"> <div style="border: 1px solid black; padding: 5px; text-align: center;">SLOW COOK</div> <div>Touch SLOW COOK pad.</div> </div>
2.	<div style="display: flex; align-items: center; gap: 10px;"> <div style="border: 1px solid black; padding: 5px; text-align: center;">SLOW COOK</div> <div>Touch SLOW COOK pad once more if you want to change the temperature from 300°F.</div> </div>
3.	<div style="display: flex; align-items: center; gap: 10px;"> <div style="border: 1px solid black; padding: 5px; text-align: center;"> 3 <small>275°</small> </div> <div>Select the temperature.</div> </div>
4.	<div style="display: flex; align-items: center; gap: 10px;"> <div style="border: 1px solid black; padding: 5px; text-align: center;"> START <hr style="width: 80%; margin: 0 auto;"/> INSTANT ON </div> <div>Touch START pad.</div> </div>





NOTE: If you do not change the temperature, omit steps 2 and 3.

SPECIAL FEATURES

AUTO DEFROST

Auto Defrost automatically defrosts foods shown in the chart below.

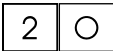
* Suppose you want to defrost a 2.0 pound steak:

Procedure	
1.	 Touch AUTO DEFROST pad once.
2.	 x2 Select desired food by touching AUTO DEFROST pad until the display shows the food name. (Ex. touch twice for steak)
3.	 Enter weight by touching the number pads. (ex. 2.0 lbs.)
4.	 Touch START pad.
The oven will stop and directions will be displayed. Follow the indicated message.	

5. After the 1st stage, open the door. Turn steak over and shield any warm portions. Close the door.



Touch START pad.

6. After the 2nd stage, open the door. Shield any warm portions. Close the door.



Touch START pad.

7. After defrost cycle ends, cover and let stand as indicated in chart below.

NOTE:

- If you attempt to enter more or less than the allowed amount as indicated in chart below, an error message will appear in the display.
- Auto Defrost can be programmed with More or Less Time Adjustment. Touch the POWER LEVEL pad once or twice after selecting the amount. See page 23.
- To defrost other foods or foods above or below the weights allowed on AUTO DEFROST CHART, use time and 30% power. See Manual Defrost on page 17.

AUTO DEFROST CHART

Food	Amount	Procedure
1. Ground meat	0.5–3.0 lbs. (0.3–1.3 kg.)	Remove any thawed pieces after each stage. Let stand, covered, 5–10 minutes.
2. Steaks (Chops) (Fish)	0.5–4.0 lbs. (0.3–1.8 kg.)	After each stage of defrost cycle, rearrange and if there are warm or thawed portions, shield with small flat pieces of aluminum foil. Remove any meat or fish that is nearly defrosted. Let stand, covered, 10–20 minutes.
3. Chicken pieces	0.5–3.0 lbs. (0.3–1.3 kg.)	After each stage of defrost cycle, if there are warm or thawed portions, rearrange or remove. Let stand, covered, 10–20 minutes.

NOTE: Check foods when oven signals. After final stage, small sections may still be icy. Let stand to continue thawing. Do not defrost until all ice crystals are thawed. Shielding prevents cooking from occurring before the center of the food is defrosted. Use small smooth strips of aluminum foil to cover edges and thinner sections of the food.

MANUAL DEFROST

If the food that you wish to defrost is not listed on the AUTO DEFROST CHART or is above or below the limits in the "Amount" column on the AUTO DEFROST CHART, you need to defrost manually.

You can defrost any frozen food, either raw or previously cooked, by using Power Level 3. Follow the exact 3-step procedure found under Time Cooking on page 11. Estimate defrosting time and press 3 for 30% when you select the power level.

For either raw or previously cooked frozen food the rule of thumb is approximately 5 minutes per pound. For example, defrost 5 minutes for 1 pound of frozen spaghetti sauce.

Always stop the oven periodically to remove or separate the portions that are defrosted. If food is not defrosted at the end of the estimated defrosting time, program the oven in 1 minute increments on Power Level 3 until totally defrosted.

When using plastic containers from the freezer, defrost only long enough to remove from the plastic in order to place in a microwave-safe dish.

SENSOR COOKING

Dacor's Sensor is a semi-conductor device that detects the vapor (moisture and humidity) emitted from food as it heats. The sensor adjusts the cooking times and power level for various foods and quantities.

Using Sensor Settings:

1. After oven is plugged in, wait 2 minutes before using sensor settings.
2. Be sure the exterior of the cooking container and the interior of the oven are dry. Wipe off any moisture with a dry cloth or paper towel.
3. Sensor Reheat and Popcorn can only be entered within 1 minute after cooking, opening and closing the door or touching the STOP/CLEAR pad.
4. During the first part of sensor cooking, the food name will appear on the display. Do not open the oven door or touch STOP/CLEAR during this part of the cooking cycle. The measurement of vapor will be interrupted. If this occurs, an error message will appear. To continue cooking, touch the STOP/CLEAR pad and select cooking time and variable power.

When the sensor detects the vapor emitted from the food, remainder of cooking time will appear. Door may be opened when remaining cooking time appears on the display. At this time, you may stir or season food, as desired.

5. Check food for temperature after cooking. If additional time is needed, continue to cook with variable power and time.
6. If the sensor does not detect vapor properly when popping popcorn, the oven will turn off, and the correct time of day will be displayed. If the sensor does not detect vapor properly when using sensor reheat, **ERROR** will be displayed, and the oven will turn off.
7. Any Sensor Cooking mode can be programmed with More or Less Time Adjustment. See page 23.
8. Each food has a cooking hint. Touch HELP GUIDE pad when the HELP indicator is lighted in the display.

Selecting Foods:

1. The sensor works with foods at normal storage temperature. For example, food for dinner plate reheat would be at refrigerator temperature and popcorn at room temperature.
2. Foods weighing less than 3 ounces should be reheated by time and variable power.

Covering Foods:

Some foods work best when covered. Use the cover recommended in the chart for these foods.

1. Casserole lid
2. Plastic wrap: Use plastic wrap recommended for microwave cooking. Cover dish loosely; allow approximately 1/2 inch to remain uncovered to allow steam to escape. Plastic wrap should not touch food.
3. Wax paper: Cover dish completely; fold excess wrap under dish to secure. If dish is wider than paper, overlap two pieces at least one inch to cover.

Be careful when removing any covering to allow steam to escape away from you.

Instant Sensors

Your oven has Instant Sensor Popcorn and Instant Sensor Reheat. To use either, simply touch the chosen pad. The oven will start automatically.

-Sensor Reheat

You can reheat many foods by touching just one pad. You don't need to calculate reheating time or power level.

* Suppose you want to heat prepared chili:

Procedure		
1.	<div style="border: 1px solid black; padding: 5px; width: fit-content; margin: 0 auto;">SENSOR REHEAT</div>	Touch SENSOR REHEAT pad.
<p>When sensor detects the vapor emitted from the food, remainder of reheating time will appear.</p>		

-Sensor Popcorn

*Suppose you want to pop a 3.5 oz. bag of popcorn:

Procedure		
1. Place bag on overturned 9" glass pie plate.		
2.	<div style="border: 1px solid black; padding: 5px; width: fit-content; margin: 0 auto;">POPCORN</div>	Touch POPCORN pad once.

This sensor setting works well with most brands of microwave popcorn. You may wish to try several and choose your favorite. Pop only one bag at a time. Unfold the bag and place in oven according to directions.

Use an overturned 9 or 10 inch oven proof glass pie plate on top of the turntable when popping bagged microwave popcorn.

INSTANT SENSOR CHART

Food	Amount	Procedure
Sensor Reheat	4-36 oz. (0.12 - 1.0 kg)	Place in dish or casserole slightly larger than amount to reheated. Flatten, if possible. Cover with lid, plastic wrap or wax paper. Use covers such as plastic wrap or lids with larger quantities of more dense foods such as stews.
Leftovers such as rice, potatoes, vegetables, casserole		
Soups	1-4 cups	After reheating, stir well, if possible. Foods should be very hot. If not, continue to heat with variable power and time. After stirring, recover and allow to stand 2 to 3 minutes.
Canned entrees and vegetables	4-36 oz.	Use Less Time Adjustment by touching POWER LEVEL pad twice for small quantities of canned vegetables.
Popcorn	Only 1 package at a time	Use only popcorn packaged for microwave oven use. Try several brands to decide which you like best. Do not try to pop unpopped kernels. More/Less Time Adjustment can be used to provide adjustment needed for older popcorn or individual tastes.
	3.0-3.5 oz. bag (Regular size)	Touch POPCORN pad once. This setting works well with most 3.0-3.5 oz bags of microwave popcorn.
	1.5-1.75 oz. bag (Snack size)	Touch POPCORN pad twice within 2 seconds for snack size bags. Do not try to pop unpopped kernels.

SENSOR COOK

*Suppose you want to cook a baked potato:

Procedure		
1.	SENSOR COOK	Touch SENSOR COOK pad.
2.	1	Select desired sensor setting. Touch 1 to cook baked potatoes.

3.	START INSTANT ON	Touch START pad. When sensor detects the vapor emitted from the food, the remainder of cooking time will appear.
----	-------------------------	--

SENSOR COOK CHART

Food	Amount	Procedure
1. BAKED POTATOES	1 - 8 medium	Pierce. Place on paper-towel-lined turntable. After cooking, remove from oven, wrap in aluminum foil and let stand 5 to 10 minutes.
2. FROZEN VEGETABLES	1 - 8 cups	Cover with lid or plastic wrap. After cooking, stir and let stand 3 minutes, covered.
3. FRESH VEGETABLES, SOFT		Wash and place in casserole. Add no water if vegetables have just been washed. Cover with lid for tender vegetables. Use plastic wrap for tender-crisp vegetables. Stir before standing if possible. After cooking, let stand, covered, 2-5 minutes.
Broccoli	1/4 - 2 lbs.	
Brussels sprouts	1/4 - 2 lbs.	
Cabbage	1/4 - 2 lbs.	
Cauliflower (flowerets)	1/4 - 2 lbs.	
Cauliflower (whole)	1 medium	
Spinach	1/4 - 1 lbs.	
Zucchini	1/4 - 2 lbs.	
Baked apples	2 - 4 medium (0.2 - 0.9kg)	
4. FRESH VEGETABLES, HARD		Place in casserole. Add 1-4 tbsp. water. Cover with lid for tender vegetables. Use plastic wrap cover for tender-crisp vegetables. Stir before standing, if possible. After cooking, let stand, covered, 2-5 minutes.
Carrots, sliced	1/4 - 1 1/2 lbs.	
Corn on cob	2 - 4 pcs.	
Green beans	1/4 - 1 1/2 lbs.	
Winter squash, diced halves	1/4 - 1 1/2 lbs. 1 - 2 (0.2 - 0.6kg)	
5. FROZEN ENTREES	6 - 17 oz. (0.17 - 0.48kg)	Use for frozen convenience foods. It will give satisfactory results for most brands. You may wish to try several and choose your favorite. Remove package from outer wrapping and follow package directions for covering. After cooking, let stand, covered, for 1 to 3 minutes.
6. HOT DOGS	1 - 4 servings	Place hot dog in bun and wrap in paper towel or paper napkin.
7. BACON	2 - 6 slices	Place bacon on paper plate, lined with paper towel. Bacon should not extend over the rim of plate. Cover with paper towel. Put another paper plate upside down on turntable. Place plate of bacon on top of overturned plate.
8. FISH, SEAFOOD	0.25 - 2.0 lbs. (0.2 - 0.9kg)	Arrange in ring around shallow glass dish (roll fillet with edges underneath). Cover with plastic wrap. After cooking, let stand, covered, 3 minutes.

AUTO BROIL/ROAST/BAKE





This section of the operation manual offers instructions for preparing 12 popular foods using Auto Broil, Auto Roast and Auto Bake.

After selecting the desired feature, follow the directions indicated in the display.

AUTO BROIL

Auto Broil automatically broils hamburgers, chicken pieces, steaks and fish steaks.



*Suppose you want to broil 2 hamburgers:

Procedure		
1.		Touch AUTO BROIL pad.
2.		Select desired setting. (Ex: for hamburgers, touch  .)
3.		Touch number pad to enter quantity. (Ex:  .) Follow information in display for cooking information.

For well done or rare burgers, touch POWER LEVEL pad to select More for well done or Less for rare. See More/Less Time Adjustment on page 23.

For helpful hints, simply touch HELP GUIDE anytime HELP is lighted in the display.

Caution: The oven cabinet, cavity, door, turntable, turntable support, racks and dishes will become hot. To PREVENT BURNS, use thick oven gloves when removing the food or turntable from the oven.

4.		Touch START pad.
After broil preheat cycle ends, the oven will stop and directions will be displayed. Follow the indicated message. Open the door and place hamburgers into oven. Close the door.		
5.		Touch START pad.

NOTE:

1. Auto Broil can be programmed with More/Less Time Adjustment. See page 23.
2. If you attempt to enter more or less than the allowed amount as indicated in chart below, an error message will appear in the display.
3. To broil other foods or foods above or below the weight or number allowed on AUTO BROIL CHART follow instructions in the Dacor Convection Microwave Cookbook. See Convection Broiling Chart.

AUTO BROIL CHART

Setting	Food	Amount	Rack	Procedure
1.	HAMBURGERS	1 - 8 pieces 1/4 lb. each	Low	Use this setting to broil hamburger patties. Place on low rack.
2.	CHICKEN PIECES	0.5 - 3.5 lbs. (0.3-1.5kg)	Low	Arrange pieces on low rack. After cooking, let stand, 3-5 minutes. Dark meat should be 180°F., and white meat should be 170°F.
3.	STEAKS	0.5 - 2.0 lbs. (0.3-0.9kg)	Low	Use this setting to broil steaks from 3/4" to 1" thick. Individual boneless steaks broil evenly. Place steak on low rack. For well done, touch POWER LEVEL once; for rare, touch POWER LEVEL twice.
4.	FISH STEAKS	0.5 - 2.0 lbs. (0.3-0.9kg)	Low	Use this setting to broil fish steak which is 3/4" to 1" thick. Place on low rack.

AUTO ROAST

Auto Roast automatically roasts chicken, turkey, turkey breast or pork.

*Suppose you want to roast a 2.5 pound chicken:

Procedure		
1.	AUTO ROAST	Touch AUTO ROAST pad.
2.	1	Select desired setting. (Ex: for chicken, touch 1 .)
3.	2 5	Touch number pads to enter weight. (Ex: 2.5 lbs.)
4.	START INSTANT ON	Touch START/INSTANT ON pad.

After AUTO ROAST cycle ends, a long tone will sound. Follow the indicated message.

NOTE:

1. Auto Roast can be programmed with More/Less Time Adjustment. See page 23.
2. If you attempt to enter more or less than the allowed weight as indicated in chart below, an error message will appear in the display.
3. To roast other food or foods above or below the weights allowed on AUTO ROAST CHART, check the Dacor Convection Microwave Cookbook Combination Roasting Chart.





AUTO ROAST CHART

Setting	Food	Amount	Rack	Procedure
1.	CHICKEN	2.5 - 7.5 lbs. (1.2 - 3.4 kg.)	Low	After the cycle ends, cover with foil and let stand for 5 - 10 minutes.
2.	TURKEY	6.5 - 16.0 lbs. (3.0 - 7.2 kg.)	Low	Season, as desired. Place on low rack. After the cycle ends, cover with foil and let stand 10 minutes. Internal temperature of white meat should be 170°F. and of dark meat, 180°F.
3.	TURKEY BREAST	3.0 - 6.0 lbs. (1.4 - 2.7 kg.)	Low	Season, as desired. Place on low rack. After the cycle ends, cover with foil and let stand 10 minutes. Internal temperature of white meat should be 170°F.
4.	PORK	2.0 - 3.5 lbs. (0.9 - 1.5kg.)	Low	Boneless pork loin is recommended because it cooks evenly. Place on a low rack. After cooking, remove from oven, cover with foil and allow to stand 5 - 10 minutes. Internal temperature should be 160°F.

AUTO BAKE

Auto Bake automatically bakes cakes, brownies, muffins and French fries.

* Suppose you want to bake a bundt cake:

Procedure		
1.		Touch AUTO BAKE pad.
2.		Select desired setting. (Ex: for bundt cake, touch  .)
3.		Touch START pad.

NOTE:

1. Auto Bake can be programmed with More/Less Time Adjustment. See page 23.
2. To bake other foods, see the Dacor Convection Microwave Cookbook's baking section.

AUTO BAKE CHART

Setting	Food	Pan/Qty	Rack	Procedure
1.	BUNDT CAKE	1 cake	No rack	Ideal for packaged cake mix or your own recipe. Prepare according to package or recipe directions and place in a greased and floured bundt pan. Place pan in oven. Cool before frosting and serving.
2.	COOKIES	1 or 2 pizza pans	1 pizza pan No rack 2 pizza pans High	Ideal for refrigerated cookie dough. Prepare according to package or recipe directions and place on a greased and floured 12" pizza pan. Cookies should be approximately 1/3 inch thick and 2 inches in diameter for best results. After the preheat is over, place pan in oven. Cool before serving.
3.	MUFFINS	6-12 cups 1 or 2 muffin pans	1 pan No rack 2 pans High	Ideal for packaged muffin mix or your own recipe for 6-12 medium size muffins. Prepare according to package or recipe directions and place in muffin pan. After the preheat is over, place pan in oven.
4.	FRENCH FRIES	3 to 24 oz. (0.09-0.68kg) 1 or 2 pizza pans For more than 12 oz. use 2 pans	1 pizza pan No rack 2 pizza pans High	Use frozen prepared French fries. No preheat is required for the French fries baking procedure. Place French fries on pizza pan. For shoestring potatoes, touch POWER LEVEL pad twice to enter less time before touching START pad.

OTHER CONVENIENT FEATURES

MULTIPLE SEQUENCE COOKING

The oven can be programmed for up to 4 automatic cooking sequences for the microwave mode and 2 automatic cooking sequences with preheat for convection/mix mode, switching from one power level setting to another automatically.

Sometimes cooking directions tell you to start on one power level and then change to a different power level. Your oven can do this automatically.

* Suppose you want to cook roast beef for 5 minutes at 100% and then continue to cook for 30 minutes at 50%:

Procedure	
1.	<div style="border: 1px solid black; padding: 2px; display: inline-block;">POWER LEVEL</div> <div style="display: flex; align-items: center; gap: 5px;"> x 2 <div style="border: 1px solid black; padding: 2px; display: inline-block;">5</div> <div style="border: 1px solid black; border-radius: 50%; width: 15px; height: 15px; display: inline-block;"></div> <div style="border: 1px solid black; border-radius: 50%; width: 15px; height: 15px; display: inline-block;"></div> </div> First touch POWER LEVEL pad twice for 100% power. Then enter cooking time.
2.	<div style="border: 1px solid black; padding: 2px; display: inline-block;">POWER LEVEL</div> <div style="border: 1px solid black; padding: 2px; display: inline-block; margin: 5px 0;">5</div> <div style="display: flex; align-items: center; gap: 5px;"> <div style="border: 1px solid black; padding: 2px; display: inline-block;">3</div> <div style="border: 1px solid black; border-radius: 50%; width: 15px; height: 15px; display: inline-block;"></div> <div style="border: 1px solid black; border-radius: 50%; width: 15px; height: 15px; display: inline-block;"></div> <div style="border: 1px solid black; border-radius: 50%; width: 15px; height: 15px; display: inline-block;"></div> </div> Touch POWER LEVEL pad. Touch number pad 5 for 50% power. Then enter second cooking time.
3.	<div style="border: 1px solid black; padding: 2px; display: inline-block;">START INSTANT ON</div> Touch START pad.

NOTE: 1. If POWER LEVEL pad is touched twice, **HIGH** will be displayed.

2. If you wish to know power level, simply touch the POWER LEVEL pad. As long as your finger is touching the POWER LEVEL pad, the power level will be displayed.

MORE OR LESS TIME ADJUSTMENT

More

Should you discover that you like any of the INSTANT SENSOR, SENSOR COOK, AUTO DEFROST, AUTO BROIL, AUTO ROAST or AUTO BAKE settings slightly **more** done, touch the POWER LEVEL pad **once** after touching your choice of pads.

Less

Should you discover that you like any of the INSTANT SENSOR, SENSOR COOK, AUTO DEFROST, AUTO BROIL, AUTO ROAST or AUTO BAKE settings slightly **less** done, touch the POWER LEVEL pad **twice** after touching your choice of pads.

KITCHEN TIMER

* Suppose you want to time a 3 minute long distance phone call.

Procedure	
1.	<div style="border: 1px solid black; padding: 2px; display: inline-block;">KITCHEN TIMER</div> Touch KITCHEN TIMER pad.
2.	<div style="display: flex; align-items: center; gap: 5px;"> <div style="border: 1px solid black; padding: 2px; display: inline-block;">3</div> <div style="border: 1px solid black; border-radius: 50%; width: 15px; height: 15px; display: inline-block;"></div> <div style="border: 1px solid black; border-radius: 50%; width: 15px; height: 15px; display: inline-block;"></div> </div> Enter time.
3.	<div style="border: 1px solid black; padding: 2px; display: inline-block;">START INSTANT ON</div> Touch START pad.

EASY MINUTE

Easy Minute allows you to cook for a minute at 100% by simply touching the EASY MINUTE pad. You can also extend cooking time in multiples of 1 minute by repeatedly touching the EASY MINUTE pad during manual cooking.

* Suppose you want to heat a cup of soup for one minute:

Procedure	
1.	<div style="border: 1px solid black; padding: 2px; display: inline-block;">EASY MINUTE</div> Touch EASY MINUTE pad.

NOTE: 1. To use Easy Minute, touch pad within 1 minute after cooking, closing the door, touching the STOP/CLEAR pad or during cooking.

2. Easy Minute cannot be used with SPECIAL FEATURES.

INSTANT ON

Instant On allows you to cook at 100% power by touching the START/INSTANT ON continuously. Instant On is ideal for melting cheese, bringing milk to just below boiling etc.

The maximum cooking time is 3 minutes.

* Suppose you want to melt cheese on a piece of toast:

Procedure	
1.	<div style="border: 1px solid black; padding: 2px; display: inline-block;">START INSTANT ON</div> Continuously touch the START/INSTANT ON pad. The cooking time will begin counting up.
2.	When the cheese is melted to desired degree, remove finger from START/INSTANT ON pad. Oven stops immediately.

NOTE: 1. Note time it takes for frequently used foods and program that time in the future.

2. To use Instant On, touch pad within 1 minute after cooking, opening and closing the door or touching the STOP/CLEAR pad.

3. Instant On can only be used 3 times in a row. If more times are needed, open and close door or touch STOP/CLEAR.

DEMONSTRATION MODE

To demonstrate, touch **CLOCK**, **0** and then touch **START** and hold for 3 seconds. **DEMO ON** will appear in the display. Cooking operations and specific special features can now be demonstrated with no power in the oven. For example, touch **EASY MINUTE** and the display will show **1.00** and count down quickly to **END**.

To cancel, touch **CLOCK**, then **0** and **STOP/CLEAR**.

HELP GUIDE

HELP GUIDE provides 6 features which make using your oven easy because specific instructions are provided in the Interactive Display.

- Safety Lock

The Safety Lock prevents unwanted oven operation such as by small children.

The oven can be set so that the control panel is deactivated or locked. To set, touch **HELP GUIDE**, the number **1** and **START**. Should a pad be touched, **LOCK** will appear in the display.

To cancel, touch **HELP GUIDE**, the number **1** and **STOP/CLEAR**.

- Audible Signal Elimination

If you wish to have the oven operate with no audible signals, touch **HELP GUIDE**, the number **2** and **STOP/CLEAR**.

To cancel and restore the audible signal, touch **HELP GUIDE**, the number **2** and **START**.

- Auto Start

If you wish to program your oven to begin cooking automatically at a designated time of day, follow this procedure:

* Suppose you want to start cooking a stew for 20 minutes on 50% at 4:30. Before setting, check to make sure the clock is showing the correct time of day.

Procedure		
1.	HELP GUIDE	Touch HELP GUIDE .
2.	3	Touch the number 3 to select the Auto Start.
3.	4 3 ○	Enter the start time.

4.	CLOCK	Touch CLOCK pad.
5.	POWER LEVEL 5 2 ○ ○ ○	Enter cooking program.
6.	START INSTANT ON	Touch START pad. The chosen Auto Start time will appear in the display.

NOTE: 1. Auto Start can be used for manual cooking Auto Broil/Roast/Bake, if clock is set.

- If the oven door is opened after programming Auto Start, it is necessary to touch the **START** pad for Auto Start time to appear in the readout so that the oven will automatically begin programmed cooking at the chosen Auto Start time.
- Be sure to choose foods that can be left in the oven safely until the Auto Start time. Acorn or butternut squash are often a good choice.
- If you wish to know the time of day, simply touch the **CLOCK** pad. As long as your finger is touching the **CLOCK** pad, the time of day will be displayed.

- Language Selection

The oven comes set for English language. To change, touch **HELP GUIDE** and the number **4**. Continue to touch the number **4** until your choice is selected from the table below. Then, touch **START/INSTANT ON** pad.

Number 4	Language	Display
Once	English	ENGLISH
Twice	Espanol	ESPAÑOL
3 Times	French	FR

- Weight/Temp Selection

The oven comes set for U.S. Customary Unit-pounds. To change, touch **HELP GUIDE** and the number **5**. Continue to touch the number **5** until your choice is selected from the table below. Then, touch **START/INSTANT ON** pad.

Number 5	Standard of Weight and Temperature	Display
Once	LB. °F	LB F
Twice	KG °C	KG C

- Help

Each setting of Auto Defrost, Auto Broil, Auto Roast, Auto Bake, Sensor Cook and Instant Sensor has a cooking hint. If you wish to check, touch **HELP GUIDE** whenever **HELP** is lighted in the interactive display.

CLEANING AND CARE

Disconnect the power cord before cleaning. If possible, leave the door open to inactivate the oven during cleaning.

Exterior

The outside surface is precoated metal and plastic. Clean the outside with mild soap and water; rinse and dry with a soft cloth. Do not use any type of household or abrasive cleaner.

Door

Wipe the window on both sides with a damp cloth to remove any spills or splatters. Metal parts will be easier to maintain if wiped frequently with a damp cloth. Avoid the use of harsh abrasives.

Touch Control Panel

Wipe the panel with a cloth dampened slightly with water only. Dry with a soft cloth. Do not scrub or use any sort of chemical cleaners. Close door and touch STOP/CLEAR.

Interior - after microwave cooking.

Cleaning is easy because no heat is generated to the interior surfaces; therefore, there is no baking and setting of spills or spattering. To clean the interior surfaces, wipe with a soft cloth and warm water. **DO NOT USE ABRASIVE OR HARSH CLEANERS OR SCOURING PADS.** For heavier soil, use mild soap; rinse thoroughly with hot water.

Interior - after convection, mix or broil cooking.

Spatters may occur because of moisture and grease. Wash immediately after use with hot, soapy water. Rinse and polish dry. Harder to remove spatters may occur if oven is not thoroughly cleaned or if there is long time/high temperature cooking. If so, you may wish to purchase an oven cleaner pad with liquid cleaner within it--not a soap filled steel pad--for use on stainless or porcelain surfaces.

Follow manufacturer's directions carefully and be especially cautious not to get any of the liquid cleaner in the perforations on the wall or ceiling or any door surfaces.

Rinse thoroughly and polish dry.

After cleaning the interior thoroughly, residual grease may be removed from the interior ducts and heater by simply operating the oven on 450°F. for 20 minutes without food. Ventilate the room if necessary.

Waveguide Cover

Carefully wash any food particles from the waveguide cover located on the ceiling in the oven cavity.

Odor Removal

Occasionally, a cooking odor may remain in the oven. To remove, combine 1 cup water, grated peel and juice of 1 lemon, and several whole cloves in a 2 cup glass measuring cup. Boil for several minutes using 100% power. Allow to set in oven until cool. Wipe interior with a soft cloth.

Turntable/Turntable Support/Racks

The turntable, turntable support and racks can be removed for easy cleaning. Wash them in mild, sudsy water; for stubborn stains use a mild cleanser and a non-abrasive scouring sponge. They are also dishwasher-proof. Use top rack of dishwasher for turntable support. Foods with high acidity, such as tomatoes or lemons, will cause the porcelain enamel turntable to discolor. Do not cook highly acidic foods directly on the turntable; if spills occur, wipe up immediately. The turntable motor shaft is not sealed, so excess water or spills should not be allowed to stand in this area.

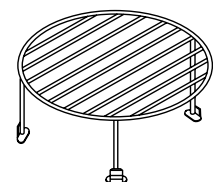
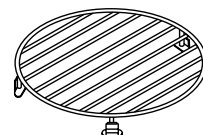
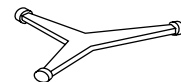
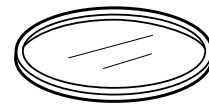
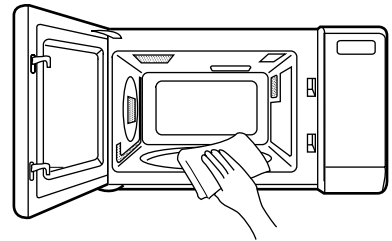
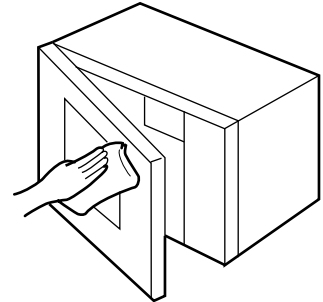

SERVICE CALL CHECK

Please check the following before calling for service:

1. Place one cup of water in a glass measuring cup in the oven and close the door securely.
Operate the oven for two minutes at HIGH 100%.
 - A. Does the oven light come on? YES _____ NO _____
 - B. Does the cooling fan work? YES _____ NO _____
(Put your hand over the rear ventilating openings.)
 - C. Does the turntable rotate? YES _____ NO _____
It is normal for the turntable to turn in either direction.
 - D. Is the water in the oven hot? YES _____ NO _____
2. Remove water from the oven and operate the oven for 5 minutes at CONV 450°F.
 - A. Do CONV and COOK indicators light? YES _____ NO _____
 - B. After the oven shuts off, is inside of the oven hot? YES _____ NO _____

If "NO" is the answer to any of the above questions, please check electrical outlet, fuse and/or circuit breaker.

If both are functioning properly, CONTACT YOUR NEAREST AUTHORIZED DACOR SERVICER. A microwave oven should never be serviced by a "do-it-yourself" repair person.

NOTE: If time appearing in the display is counting down very rapidly, check Demonstration Mode on page 24 and cancel.

SPECIFICATIONS

AC Line Voltage:	Single phase 120V, 60Hz, AC only
AC Power Required:	1.55 kW 13.0A (Microwave) 1.55 kW 13.0A (Convection)
Output Power:	
Microwave	900W*(IEC Test Procedure)
Convection Heater	1450W
Frequency:	2450 MHz
Outside Dimensions:	24 5/8"(W) x 14 7/8"(H) x 19"(D)
Cavity Dimensions:	16 1/8"(W) x 9 5/8"(H) x 16 1/8"(D)
Oven Capacity:	1.5 cft
Cooking Uniformity:	Turntable system
Weight:	Approx. 60 lbs.

* the International Electrotechnical Commission's standardized method for measuring output wattage. This test method is widely recognized.

In compliance with standards set by:

FCC – Federal Communications Commission Authorized.

DHHS – Complies with Department of Health and Human Services (DHHS) rule, CFR, Title 21, Chapter I, Subchapter J.



– This symbol on the nameplate means the product is listed by Underwriters Laboratories, Inc.











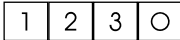







GUIA PANEL DE CONTROL

Para mayor información y precauciones de seguridad, consulte el Manual de Operaciones.

<p>FIJACION DEL RELOJ Si en la pantalla aparece WELCOME PRESS CLEAR AND PRESS CLOCK, toque primero STOP/CLEAR.</p> <ol style="list-style-type: none"> 1. Toque el botón CLOCK. 2. Ponga la hora correcta tocando los números en orden. (Ej. 12:30) 3. Toque nuevamente el botón CLOCK. 	<p>CLOCK</p> <p>1 2 3 0</p> <p>CLOCK</p>	<p>INSTANT ON Toque el botón START/INSTANT ON y mántelo presionado para cocinar a un 100% del nivel de energía. Al retirar el dedo del botón, el horno se detendrá instantáneamente.</p>	<p>START INSTANT ON</p>
<p>SELECCIÓN DEL IDIOMA ESPAÑOL</p> <ol style="list-style-type: none"> 1. Toque HELP GUIDE. 2. Presione 4 para seleccionar el idioma. 3. Presione 4 para seleccionar Español. 4. Toque START. 	<p>HELP GUIDE</p> <p>4</p> <p>4</p> <p>START INSTANT ON</p>	<p>OPERACION MANUAL Cocinando con energía alta</p> <ol style="list-style-type: none"> 1. Programe el tiempo para cocinar tocando los botones de números. (Ej. 1 min. 30 seg.) 2. Toque START. <p>Cocinando con energía variable</p> <ol style="list-style-type: none"> 1. Después del paso 1 anterior, toque el botón POWER LEVEL. 2. Escoja el nivel de energía. (Ej. 50%) 3. Toque START. 	<p>1 3 0</p> <p>START INSTANT ON</p> <p>POWER LEVEL</p> <p>5</p> <p>START INSTANT ON</p>
<p>SENSOR INSTANTANEO</p> <ol style="list-style-type: none"> 1. Toque el botón SENSOR REHEAT o POPCORN. (Una vez-regular, 2 veces-snack) 	<p>SENSOR REHEAT</p>	<p>AUTO BROIL/AUTO ROAST/AUTO BAKE</p> <ol style="list-style-type: none"> 1. Toque el botón AUTO BROIL. 2. Seleccione el ajuste AUTO BROIL deseado. (Ej: Toque [1] para hamburguesas.) 3. Toque el botón número [2] para 2 hamburguesas. 4. Toque START. 	<p>AUTO BROIL</p> <p>1</p> <p>2</p> <p>START INSTANT ON</p>
<p>AUTO DEFROST</p> <ol style="list-style-type: none"> 1. Toque el botón AUTO DEFROST. 2. Seleccione la programación deseada para AUTO DEFROST. (Ej. Toque el botón AUTO DEFROST para filetes.) 3. Toque los botones número [2] y [0]. (Ej. filete de 2,0 libras) 4. Toque START. Durante el descongelamiento, el horno se detendrá para que usted pueda revisar el alimento. Toque el botón START. 	<p>AUTO DEFROST</p> <p>AUTO DEFROST</p> <p>x 2</p> <p>2 0</p> <p>START INSTANT ON</p>	<p>PRECALENTAMIENTO Y COCCIÓN CON CONVECCIÓN</p> <ol style="list-style-type: none"> 1. Toque el botón PREHEAT. 2. Seleccione la temperatura de precalentamiento deseada. (Ej: 325°F) 3. Toque el botón CONVECTION. 4. Seleccione la temperatura de cocción. (Ej: 350°F) 5. Introduzca el tiempo de cocción tocando los botones de números. (Ej: 20 min.) 6. Toque START. 	<p>PREHEAT</p> <p>5 325°</p> <p>CONVECTION</p> <p>6 350°</p> <p>2 0 0 0</p> <p>START INSTANT ON</p>
<p>SENSOR COOK</p> <ol style="list-style-type: none"> 1. Toque el botón SENSOR COOK. 2. Seleccione la programación deseada para SENSOR COOK. (Ej. Toque el botón [1] para papas al horno.) 3. Toque el botón START. 	<p>SENSOR COOK</p> <p>1</p> <p>START INSTANT ON</p>	<p>MEZCLA AUTOMÁTICA</p> <ol style="list-style-type: none"> 1. Toque LOW MIX/BAKE o HIGH MIX/ROAST. 2. Introduzca el tiempo de cocción tocando los botones de números. (Ej: 25 min.) 3. Toque START. 	<p>LOW MIX BAKE</p> <p>2 5 0 0</p> <p>START INSTANT ON</p>
<p>EASY MINUTE Toque el botón de adición de un minuto (EASY MINUTE) para un minuto al 100% de energía, o para añadir un minuto cuando cocine en el modo manual.</p>	<p>EASY MINUTE</p>	<p>ASADO</p> <ol style="list-style-type: none"> 1. Toque BROIL. Sin haber comido en el horno. 2. Introduzca el tiempo deseado tocando los botones de números. (Ej: 14 min.) 3. Toque START. Cuando avise el horno, ponga la comida en su interior. 	<p>BROIL</p> <p>1 4 0 0</p> <p>START INSTANT ON</p>

CONTROL PANEL GUIDE

For more complete information and safety precautions, refer to your Operation Manual.

<p>SET CLOCK If WELCOME PRESS CLEAR AND PRESS CLOCK is in display, first touch STOP/CLEAR.</p> <ol style="list-style-type: none"> 1. Touch CLOCK pad. 2. Enter correct time of day by touching numbers in sequence. (Ex: 12:30) 3. Touch CLOCK pad again. 	  	<p>Variable Power Cooking</p> <ol style="list-style-type: none"> 1. Enter cooking time by touching number pads. (Ex: 5 min) 2. Touch POWER LEVEL pad. 3. Select power level. (Ex: 50%) 4. Touch START pad. 	   																											
<p>INSTANT SENSOR</p> <ol style="list-style-type: none"> 1. Touch SENSOR REHEAT 																														
<p>INSTANT SENSOR CHART</p> <table border="1"> <thead> <tr> <th>Food</th> <th>Amount</th> </tr> </thead> <tbody> <tr> <td>Popcorn</td> <td>one touch for 3.0-3.5 oz. bags two touches for 1.5-1.75 oz. bags</td> </tr> <tr> <td rowspan="2">Reheat</td> <td>Leftovers</td> <td>4-36 oz.</td> </tr> <tr> <td>Canned entrees and vegetables</td> <td>4-36 oz.</td> </tr> </tbody> </table>			Food	Amount	Popcorn	one touch for 3.0-3.5 oz. bags two touches for 1.5-1.75 oz. bags	Reheat	Leftovers	4-36 oz.	Canned entrees and vegetables	4-36 oz.	<p>SENSOR COOK</p> <ol style="list-style-type: none"> 1. Touch SENSOR COOK pad. 2. Select desired SENSOR COOK setting. (Ex: Touch 1 to cook baked potatoes.) 3. Touch START. 	  																	
Food	Amount																													
Popcorn	one touch for 3.0-3.5 oz. bags two touches for 1.5-1.75 oz. bags																													
Reheat	Leftovers	4-36 oz.																												
	Canned entrees and vegetables	4-36 oz.																												
<p>AUTO DEFROST</p> <ol style="list-style-type: none"> 1. Touch AUTO DEFROST pad. 2. Select desired AUTO DEFROST setting. (Ex: Touch AUTO DEFROST twice to defrost steak.) 3. Touch number pads 2 and 0. (Ex: 2.0 lbs. steak) 4. Touch START. <p>During defrosting, oven will stop, check food. Touch START to continue defrosting.</p>	  x 2  	<p>SENSOR COOK CHART</p> <table border="1"> <thead> <tr> <th>Setting</th> <th>Food</th> <th>Amount</th> </tr> </thead> <tbody> <tr> <td>1</td> <td>BAKED POTATOES</td> <td>1-8 medium</td> </tr> <tr> <td>2</td> <td>FROZEN VEGETABLES</td> <td>1-8 cups</td> </tr> <tr> <td>3</td> <td>FRESH VEGETABLES, SOFT</td> <td>0.25-2.0 lbs.</td> </tr> <tr> <td>4</td> <td>FRESH VEGETABLES, HARD</td> <td>0.25-1.5 lbs.</td> </tr> <tr> <td>5</td> <td>FROZEN ENTREE</td> <td>6-17 oz.</td> </tr> <tr> <td>6</td> <td>HOT DOGS</td> <td>1-4</td> </tr> <tr> <td>7</td> <td>BACON</td> <td>2-6 slices</td> </tr> <tr> <td>8</td> <td>FISH, SEAFOOD</td> <td>0.25-2.0 lbs.</td> </tr> </tbody> </table>	Setting	Food	Amount	1	BAKED POTATOES	1-8 medium	2	FROZEN VEGETABLES	1-8 cups	3	FRESH VEGETABLES, SOFT	0.25-2.0 lbs.	4	FRESH VEGETABLES, HARD	0.25-1.5 lbs.	5	FROZEN ENTREE	6-17 oz.	6	HOT DOGS	1-4	7	BACON	2-6 slices	8	FISH, SEAFOOD	0.25-2.0 lbs.	
Setting	Food	Amount																												
1	BAKED POTATOES	1-8 medium																												
2	FROZEN VEGETABLES	1-8 cups																												
3	FRESH VEGETABLES, SOFT	0.25-2.0 lbs.																												
4	FRESH VEGETABLES, HARD	0.25-1.5 lbs.																												
5	FROZEN ENTREE	6-17 oz.																												
6	HOT DOGS	1-4																												
7	BACON	2-6 slices																												
8	FISH, SEAFOOD	0.25-2.0 lbs.																												
<p>AUTO DEFROST CHART</p> <table border="1"> <thead> <tr> <th>Setting</th> <th>Food</th> <th>Amount</th> </tr> </thead> <tbody> <tr> <td>1</td> <td>Ground meat</td> <td>0.5-3.0 lbs.</td> </tr> <tr> <td>2</td> <td>Steaks, (chops), (fish)</td> <td>0.5-4.0 lbs.</td> </tr> <tr> <td>3</td> <td>Chicken pieces</td> <td>0.5-3.0 lbs.</td> </tr> </tbody> </table>			Setting	Food	Amount	1	Ground meat	0.5-3.0 lbs.	2	Steaks, (chops), (fish)	0.5-4.0 lbs.	3	Chicken pieces	0.5-3.0 lbs.	<p>EASY MINUTE</p> <p>Touch Easy Minute for one minute at 100% power or to add a minute during manual cooking.</p>															
Setting	Food	Amount																												
1	Ground meat	0.5-3.0 lbs.																												
2	Steaks, (chops), (fish)	0.5-4.0 lbs.																												
3	Chicken pieces	0.5-3.0 lbs.																												
<p>MANUAL OPERATION</p> <p>High Power Cooking</p> <ol style="list-style-type: none"> 1. Enter cooking time by touching number pads. (Ex: 1 min. 30 sec.) 2. Touch START pad. 	 	<p>INSTANT ON</p> <p>Continuously touch START/INSTANT ON for 100% power cooking. Remove finger and oven will stop instantly.</p>																												

<p>AUTO BROIL</p> <p>1. Touch AUTO BROIL pad.</p> <p>2. Select desired AUTO BROIL setting. (Ex: Touch <input type="text" value="1"/> for hamburgers.)</p> <p>3. Touch number <input type="text" value="2"/> pad for 2 hamburgers.</p> <p>4. Touch START.</p>	<p><input type="text" value="AUTO BROIL"/></p> <p><input type="text" value="1"/></p> <p><input type="text" value="2"/></p> <p><input type="text" value="START INSTANT ON"/></p>	<p>PREHEAT AND COOK WITH CONVECTION</p> <p>1. Touch PREHEAT pad.</p> <p>2. Select desired preheat temperature. (Ex: 325°F)</p> <p>3. Touch CONVECTION pad.</p> <p>4. Select cooking temperature. (Ex: 350°F)</p> <p>5. Enter cooking time by touching number pads. (Ex: 20 min.)</p> <p>6. Touch START.</p>	<p><input type="text" value="PREHEAT"/></p> <p><input type="text" value="5"/> 325°</p> <p><input type="text" value="CONVECTION"/></p> <p><input type="text" value="6"/> 350°</p> <p><input type="text" value="2"/> <input type="text" value="0"/> <input type="text" value="0"/> <input type="text" value="0"/></p> <p><input type="text" value="START INSTANT ON"/></p>															
<p>AUTO BROIL CHART</p> <table border="1"> <thead> <tr> <th>Setting</th> <th>Food</th> <th>Amount</th> </tr> </thead> <tbody> <tr> <td>1</td> <td>HAMBURGERS</td> <td>1-8 pieces</td> </tr> <tr> <td>2</td> <td>CHICKEN PIECES</td> <td>0.5-3.5 lbs.</td> </tr> <tr> <td>3</td> <td>STEAKS</td> <td>0.5-2.0 lbs.</td> </tr> <tr> <td>4</td> <td>FISH STEAKS</td> <td>0.5-2.0 lbs.</td> </tr> </tbody> </table>		Setting	Food	Amount	1	HAMBURGERS	1-8 pieces	2	CHICKEN PIECES	0.5-3.5 lbs.	3	STEAKS	0.5-2.0 lbs.	4	FISH STEAKS	0.5-2.0 lbs.	<p>AUTOMATIC MIX COOKING</p> <p>1. Touch LOW MIX/BAKE or HIGH MIX/ROAST. (Ex: Low Mix/Bake)</p> <p>2. Enter cooking time by touching number pads. (Ex: 25 min.)</p> <p>3. Touch START.</p> <p>NOTE: If you want to change temperature, touch the selected AUTOMATIC MIX pad again after step 1 and touch desired temperature pad.</p>	<p><input type="text" value="LOW MIX BAKE"/></p> <p><input type="text" value="2"/> <input type="text" value="5"/> <input type="text" value="0"/> <input type="text" value="0"/></p> <p><input type="text" value="START INSTANT ON"/></p>
Setting	Food	Amount																
1	HAMBURGERS	1-8 pieces																
2	CHICKEN PIECES	0.5-3.5 lbs.																
3	STEAKS	0.5-2.0 lbs.																
4	FISH STEAKS	0.5-2.0 lbs.																
<p>AUTO ROAST</p> <p>1. Touch AUTO ROAST pad.</p> <p>2. Select desired AUTO ROAST setting. (Ex: Touch <input type="text" value="1"/> for chicken.)</p> <p>3. Touch number pad <input type="text" value="2"/> and <input type="text" value="5"/>.</p> <p>(Ex: 2.5 lbs. chicken)</p> <p>4. Touch START.</p>		<p>BROILING</p> <p>1. Touch BROIL. No food in oven.</p> <p>2. Enter desired time by touching number pads. (Ex. 14 min.)</p> <p>3. Touch START. When oven signals, put food in oven.</p>	<p><input type="text" value="BROIL"/></p> <p><input type="text" value="1"/> <input type="text" value="4"/> <input type="text" value="0"/> <input type="text" value="0"/></p> <p><input type="text" value="START INSTANT ON"/></p>															
<p>AUTO ROAST CHART</p> <table border="1"> <thead> <tr> <th>Setting</th> <th>Food</th> <th>Amount</th> </tr> </thead> <tbody> <tr> <td>1</td> <td>CHICKEN</td> <td>2.5 - 7.5 lbs.</td> </tr> <tr> <td>2</td> <td>TURKEY</td> <td>6.5 - 16.0 lbs.</td> </tr> <tr> <td>3</td> <td>TURKEY BREAST</td> <td>3.0 - 6.0 lbs.</td> </tr> <tr> <td>4</td> <td>PORK</td> <td>2.0 - 3.5 lbs.</td> </tr> </tbody> </table>		Setting	Food	Amount	1	CHICKEN	2.5 - 7.5 lbs.	2	TURKEY	6.5 - 16.0 lbs.	3	TURKEY BREAST	3.0 - 6.0 lbs.	4	PORK	2.0 - 3.5 lbs.	<p>SLOW COOK</p> <p>1. Touch SLOW COOK pad.</p> <p>2. Touch START.</p> <p>NOTE: If you want to change the temperature (below 300°F), touch SLOW COOK pad again after step 1 and touch desired temperature pad.</p>	<p><input type="text" value="SLOW COOK"/></p> <p><input type="text" value="START INSTANT ON"/></p>
Setting	Food	Amount																
1	CHICKEN	2.5 - 7.5 lbs.																
2	TURKEY	6.5 - 16.0 lbs.																
3	TURKEY BREAST	3.0 - 6.0 lbs.																
4	PORK	2.0 - 3.5 lbs.																
<p>AUTO BAKE</p> <p>1. Touch AUTO BAKE pad.</p> <p>2. Select desired AUTO BAKE setting. (Ex: Touch <input type="text" value="1"/> for bundt cake.)</p> <p>3. Touch START.</p>		<p><input type="text" value="AUTO BAKE"/></p> <p><input type="text" value="1"/></p> <p><input type="text" value="START INSTANT ON"/></p>																
<p>AUTO BAKE CHART</p> <table border="1"> <thead> <tr> <th>Setting</th> <th>Food</th> <th>Amount</th> </tr> </thead> <tbody> <tr> <td>1</td> <td>BUNDT CAKE</td> <td>1 cake</td> </tr> <tr> <td>2</td> <td>COOKIES</td> <td>1-2 pizza pans</td> </tr> <tr> <td>3</td> <td>MUFFINS</td> <td>6-12 cups</td> </tr> <tr> <td>4</td> <td>FRENCH FRIES</td> <td>3-24 oz.</td> </tr> </tbody> </table>		Setting	Food	Amount	1	BUNDT CAKE	1 cake	2	COOKIES	1-2 pizza pans	3	MUFFINS	6-12 cups	4	FRENCH FRIES	3-24 oz.		
Setting	Food	Amount																
1	BUNDT CAKE	1 cake																
2	COOKIES	1-2 pizza pans																
3	MUFFINS	6-12 cups																
4	FRENCH FRIES	3-24 oz.																



Distinctive Appliance Corporation
1440 Bridge Gate Drive
Diamond Bar, CA 91765
For Dealer/Service: (800)772-7778
Corporate Headquarters: (800)793-0093
Fax: (626)441-9632
Planning Guide fax-back: (800)793-0093 ext. 3806
<http://www.dacor.com>

Free Manuals Download Website

<http://myh66.com>

<http://usermanuals.us>

<http://www.somanuals.com>

<http://www.4manuals.cc>

<http://www.manual-lib.com>

<http://www.404manual.com>

<http://www.luxmanual.com>

<http://aubethermostatmanual.com>

Golf course search by state

<http://golfingnear.com>

Email search by domain

<http://emailbydomain.com>

Auto manuals search

<http://auto.somanuals.com>

TV manuals search

<http://tv.somanuals.com>