

DAEWOO 
ELECTRONICS



DVD Recorder + VCR

DRV-6815

User Manual



Safety Instructions

Please keep the product's guarantee sheet and receipt in a safe place.

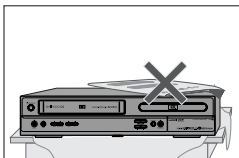
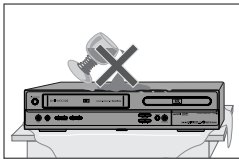
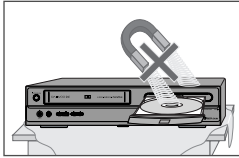
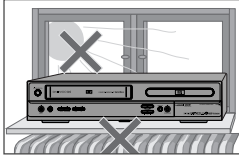

Precautions

- Read this booklet carefully.
- Make sure the rating of your household electricity supply matches that shown on the back of your product.
- Read this page and chapter 'Setting up your product' to help you set up and adjust your product correctly.
- Do not put the product in a hot or humid place.
- Do not open the product. Get a qualified technician to carry out any repairs.
- Do not connect the product to the power supply if you have just moved it from a cold environment to a warm room. This can lead to condensation inside the product, which can damage it. Wait for approx. 2 hrs for it to reach room temperature.
- Make sure the product is placed at least 10 cm apart from other home appliances or obstacles to ensure sufficient ventilation.
- The product should not be exposed to dripping or splashing and no objects filled with liquids, such as vases should be placed on top of the product.
- Before a storm and/or lightning, unplug the product from the mains supply and aerial.
- Put the product on a steady flat surface.
- Only clean the product with a soft, lint-free cloth. Do not use harsh or alcohol-based cleaning agents.

For your own Safety





- There are no components in this product you can service or repair yourself.
- Do not open the case of the product. Only allow a qualified engineer to repair or service your product.



- This product is designed to work continuously. Switching it off (stand-by mode) does not disconnect it from the mains. To disconnect it from the mains you have to unplug it.

Important Safeguards

	CAUTION RISK OF ELECTRIC SHOCK DO NOT OPEN	
<p>CAUTION: TO REDUCE THE RISK OF ELECTRIC SHOCK, DO NOT REMOVE COVER (OR BACK). NO USER-SERVICEABLE PARTS INSIDE. REFER SERVICING TO QUALIFIED SERVICE PERSONNEL.</p>		

The lightning flash with arrowhead symbol, within an equilateral triangle, is intended to alert the user to the presence of uninsulated 'dangerous voltage' within the product's enclosure that may be of sufficient magnitude to constitute a risk of electric shock.



The exclamation point within an equilateral triangle is intended to alert the user to the presence of important operating and servicing instructions in the literature accompanying the appliance.



<p>WARNING TO REDUCE THE RISK OF FIRE OR ELECTRIC SHOCK, DO NOT EXPOSE THIS APPLIANCE TO RAIN OR MOISTURE.</p> <p>CAUTION TO PREVENT ELECTRIC SHOCK, MATCH WIDE BLADE OF PLUG TO WIDE SLOT, FULLY INSERT.</p>

<p>CAUTION Any changes or modification in construction of this device which are not expressly approved by the party responsible for compliance could void the user's authority to operate the equipment.</p>

IMPORTANT FOR LASER PRODUCTS

LASER This Digital Video Disc Player employs a Laser System. To ensure proper use of this product please read this owner's manual carefully and retain for future reference. Should the unit require maintenance, contact an authorized service location - see service procedure. Use of control adjustments or the performance of procedures other than those specified may result in hazardous radiation exposure. To prevent direct exposure to the laser beam, do not try to open the enclosure. Visible laser radiation when open and interlocks defeated. **DO NOT STARE INTO THE BEAM.**

DANGER Visible laser radiation when open and interlock failed or defeated. Avoid direct exposure to beam.



CAUTION Do not open the top cover. There are no user serviceable parts inside the Unit; leave all servicing to qualified service personnel.

This set has been designed and manufactured to assure personal safety. Improper use can result in electric shock or fire hazard. The safeguards incorporated in this unit will protect you if you observe the following procedures for installation, use and servicing. This unit is fully transistorized and does not contain any parts that can be repaired by the user.

1 READ INSTRUCTIONS

All the safety and operating instructions should be read before the unit is operated.

2 RETAIN INSTRUCTIONS

The safety and operating instructions should be retained for future reference.

3 HEED WARNINGS

All warnings on the unit and in the operating instructions should be adhered to.

4 FOLLOW INSTRUCTIONS

All operating and use instructions should be followed.

5 CLEANING

Unplug this unit from the wall outlet before cleaning. Do not use liquid cleaners or aerosol cleaners. Use a damp cloth for cleaning.

6 ATTACHMENTS

Do not use attachments unless recommended by the unit's manufacturer as they may cause hazards.

7 WATER AND MOISTURE

Do not use this unit near water- for example, near a bath tub, wash bowl, kitchen sink or laundry tub, in a wet basement, or near a swimming pool.

8 ACCESSORIES

Do not place this unit on an unstable cart, stand, tripod, bracket, or table. The unit may fall, causing serious injury to a child or adult as well as serious damage to the unit. Use this unit only with a cart, stand, tripod, bracket, or table recommended by the manufacturer.

- 8A A unit and cart combination should be moved with care. Quick stops, excessive force, and uneven surfaces may cause the product and cart combination to overturn.

PORTABLE CART WARNING
(symbol provided by RETAC)



9 VENTILATION

Slots and openings in the case are provided for

ventilation to ensure reliable operation of the unit and to protect it from overheating. These openings must not be blocked or covered. These openings must not be blocked by placing the unit on a bed, sofa, rug, or other similar surface. This unit should never be placed near or over a radiator or heat radiator. This unit should not be placed in a built-in installation such as a bookcase or rack unless proper ventilation is provided or the manufacturer's instructions have been adhered to.

10 POWER SOURCES

This unit should be operated only from the type of power source indicated on the marking label. If you are not sure of the type of power supply to your home, consult your dealer or local power company. For units intended to operate from battery power, or other sources, refer to the operating instructions. MAINS plug is used as the disconnect device, the disconnect device shall remain readily operable.

11 POWER-CORD PROTECTION

Power-supply cords should be routed so that they are not likely to be walked on or pinched by items placed upon or against them, paying particular attention to cords at plugs, mains sockets, and the point where they exit from the unit.

12 LIGHTNING

For added protection for this unit during a lightning storm, or when it is left unattended and unused for long periods of time, unplug it from the wall outlet and disconnect the antenna or cable system. This will prevent damage to the unit due to lightning and power line surges.

13 DISC TRAY

Keep your fingers well clear of the disc as it is closing. It may cause serious personal injury.

14 OVERLOADING

Do not overload wall outlets of extension cords as this can result in a risk of fire or electric shock.

15 OBJECT AND LIQUID ENTRY

Never push objects of any kind into this unit through openings as they may touch dangerous voltage points or 'short-out' parts that could result in a fire or electric shock. Never spill liquid of any kind on the unit.

16 BURDEN

Do not place a heavy object on or step on the product. The object may fall, causing serious

personal injury and serious damage to the product.

17 DISC

Do not use a cracked, deformed or repaired disc. These discs are easily broken and may cause serious personal injury and product malfunction.

18 SERVICING

Do not attempt to service this unit yourself as opening or removing covers may expose you to dangerous voltage or other hazards. Refer all servicing to qualified service personnel.

19 DAMAGE REQUIRING SERVICE

Unplug this unit from the wall outlet and refer servicing to qualified service personnel under the following conditions.

- A. When the power-supply cord or plug is damaged.
- B. If liquid has been spilled, or objects have fallen into the unit.
- C. If the unit has been exposed to rain or water.
- D. If the unit does not operate normally by following the operating instructions. Adjust only those controls that are covered by the operating instructions. Improper adjustment of other controls may result in damage and will often require extensive work by a qualified technician to restore the unit to its normal operation.
- E. If the unit has been dropped or the cabinet has been damaged.
- F. When the unit exhibits a distinct change in performance-this indicates a need for service.

20 REPLACEMENT PARTS

When replacement parts are required, have the service technician verify that the replacements he uses have the same safety characteristics as the original parts. Use of replacements specified by the unit manufacturer can prevent fire, electric shock, or other hazards.

21 SAFETY CHECK

Upon completion of any service or repairs to this unit, ask the service technician to perform safety checks recommended by the manufacturer to determine that the unit is in safe operating condition.

22 WALL OR CEILING MOUNTING

The product should be mounted to a wall or ceiling only as recommended by the manufacturer.

23 HEAT

The product should be situated away from heat sources such as radiators, heat registers, stoves, or other products (including amplifiers) that produce heat.

- 24 To prevent battery electrolyte leakage, which may result in injury and damage to the unit or other objects, observe the following precautions;
 - A. All batteries must be installed with the proper polarity.
 - B. Do not mix new with old or used batteries.
 - C. Only use batteries of the same type and brand.
 - D. Remove the batteries when they are not to be used for a long period time.
 - E. When the batteries have become discharged, they must be disposed of in a safe manner which complies with all applicable laws.

25 WEEE (Waste of electrical and electronic equipment)

The meaning of the symbol on the product, its accessory or packaging indicates that this product shall not be treated as household waste. Please, dispose of this equipment at your applicable collection point for the recycling of electrical & electronic equipments waste. In the European Union and Other European countries which there are separate collection systems for used electrical and electronic product. By ensuring the correct disposal of this product, you will help prevent potential hazards to the environment and to human health, which could otherwise be caused by unsuitable waste handling of this product. The recycling of materials will help conserve natural resources. Please do not therefore dispose of your old electrical and electronic equipment with your household waste. For more detailed information about recycling of this product, please contact your local city office, your household waste disposal service or the shop where you purchased the product.



26 RoHS (Directive 2002/95/EC) Compliant



This environment-friendly product does not contain the EU RoHS restricted substances (Pb, Hg, Cd, Cr6+, PBB, and PBDE).

Table of Contents

Introduction

<i>Safety Instructions</i>	1
<i>Important Safeguards</i>	2
<i>Table of Contents</i>	5
<i>Overview</i>	6
<i>Identification of Controls</i>	10

Connections

<i>Connecting Antenna/Cable</i>	15
<i>Connecting a TV</i>	16
<i>Connecting an Amplifier/Receiver</i>	17
<i>Connecting Optional Equipment</i>	18
<i>Connecting a Digital Camcorder</i>	18
<i>Connecting a Removal Storage</i>	18

Setup

<i>Initial Installation</i>	19
<i>Setup menu</i>	20
Setup Menu Overview	20
Menu Navigation	20
INSTALLATION Settings	20
RECORDING Options Settings	23
LANGUAGE Settings	23
Preference > Video Setting	24
Preference > Audio Setting	25
Preference > Parental Control	26
Preference > Auto Setting	27
Preference > VCR	28
System > System Info	29
System > DivX(R) VOD DRM	29
System > Restore Default	29
Disc > Format	30
Disc > Finalize	30
Disc > Protect	31
Disc > Disc Label	31
Disc > Disc Info	32
<i>On-Screen Display Overview</i>	33

Playback

<i>VCR Playback</i>	35
<i>DVD Playback</i>	37
<i>Playing a Picture, Audio or DivX files</i>	39

Recording

<i>Basic Recording</i>	45
Recording to TV	45
One Touch Record (OTR)	45
Checking the Recording Time	46
To Pause the Recording	46
One Touch Copy - DVD to VHS	46
Copy Edit (DVD → VCR)	46
One Touch Copy - VHS to DVD	47
Copy Edit (VCR → DVD)	47
<i>Timer Recording</i>	48
Timer Recording using Manual Set Record Screen	48
Timer Recording using ShowView system	49
Canceling a Timer Recording	50
Stopping a Timer Recording in Progress	50
Timer Recording Troubleshooting	50
<i>Recording from an External Input</i>	51

DVD Editing

<i>DVD Playback and Editing</i>	52
Playing a DVD title	52
Erasing a DVD title	52
Protecting a DVD title	53
Renaming (Labeling) a DVD title	53
Dividing a DVD title	54
A-B Erase	54
Set Index Picture	55

Reference

<i>Troubleshooting</i>	56
<i>Technical Specifications</i>	59

Overview

DVD, DVD+R, DVD+RW?

What is a DVD?

DVD (Digital Versatile Disc) is a storage medium that combines the convenience of the compact disc with the latest digital video technology. DVD video uses modern MPEG2 data compression technology that enables an entire feature film to be stored on a single five inch disc.

How good is the resolution of DVD compared with VHS?

The razor-sharp digital images have more than 500 lines of resolution at 720 pixels per line. This is more than twice as high as VHS and even better than laser disc quality. DVD picture quality is easily comparable to the digital masters produced in recording studios.

What is a DVD+RW?

DVD+ReWritable uses 'phase change' media, the same technology on which rewritable CDs are based. A high-performance laser is used to change the reflective properties of the recording layer; this process can be repeated more than a thousand times.

What is a DVD+R?

Unlike a DVD+RW disc, a DVD+R (write-once DVD) can only be written to once. If it is not finalised after a recording, further recordings can be added to it. Old recordings can be deleted but they can no longer be overwritten. The deleted recordings (titles) are marked 'deleted title'.

Before a DVD+R can be played in a DVD player, it must be finalised in the DVD Recorder + VCR. Once this process is complete, no further recordings can be added.

What can I do with my DVD Recorder + VCR?

Your DVD Recorder + VCR is a machine for recording and playing back digital video discs with 'two-way' compatibility with the universal DVD video standard. This means:

- existing DVD video discs can be played on the recorder.
- recordings made on your DVD Recorder + VCR can be played on other DVD video players and DVD-ROM drives.

Dual Media

Supporting Disc	±RW / ±R
Recording Format	±Disc + VR format
Finalize	-RW, -R, +R
After finalising other DVD playback	All discs can playback
Consumer	Does not need selection (recording format)

Remark :

A DVD Recorder that supports 'dual media' recording allows DVD+RW format recording (+VR) on either DVD-R, DVD-RW, DVD+R or DVD+RW media. Any editing feature that is available with the +RW logical format is available on any of the media types. This system allows the flexibility for the consumer to use any of the above media formats for recording in the same system. Since the +VR format is DVD-Video compatible, the consumer can take any disk recorded on this platform and should be capable of playing it back on the majority of DVD players on the market.

Regional code

If the region number on your DVD disc does not correspond to the region number of this player, the disc cannot be played.



About Symbols

About the ⊙ Symbol

'⊙' may appear on the TV screen during operation. This icon means the function explained in this User's Guide is not available on that specific disc.

Which discs you can use

The following discs can be used in your DVD Recorder + VCR:

Playback and recording

DVD+RW (Digital Versatile Disc + ReWritable)
 DVD-RW (DVD-Rerecordable)
 DVD+R (Digital Versatile Disc + Recordable)
 DVD-R (DVD-Recordable)

Playback only

DVD Video (Digital Versatile Disc)
 VCD (Video CD)
 Audio CD (Compact Disc Digital Audio)
 CD-R (CD recordable) Audio/ CD-RW (CD rewritable)
 Audio
 Video Format : JPEG
 Audio Format : CDDA / MP3



Not all recordable CDs may be played by your player.

Disc-related Terms

Title

The main film, accompanying feature content, or music album. Each title is assigned a title reference number enabling you to locate it easily.

Chapter

Sections of a movie or a musical piece that are smaller than titles. A title is composed of one or several chapters. Each chapter is assigned a number to enable you to easily locate the chapter you want. Depending on the disc, chapters may not be labeled.

Track (Audio CD only)

Sections of a movie or a musical piece on an audio CD. Each track is assigned a number, enabling you to easily locate the track you want.

About DVD Recording

Notes on Recording

- The recording times shown are not exact because the DVD Recorder + VCR uses variable bit-rate video compression. This means that the exact recording time will depend on the material being recorded.
- When recording a TV broadcast, if the reception is poor or the picture contains interference, the recording times may be shorter.
- Discs recorded at high speeds (equal to or greater than 2X) may not be recognized.
- If you record still pictures or audio only, the recording time may be longer.
- The displayed times for recording and time remaining may not always add up to the exact length of the disc.
- The available recording time may decrease if you heavily edit a disc.
- When using a DVD+R disc, you can keep recording until the disc is full, or until you finalise the disc. Before you start a recording session, check the amount of recording time left on the disc.

Recording TV Audio Channels

The DVD Recorder + VCR can record one or two channel audio. For TV broadcasts, this usually means mono or stereo, but some programs are broadcast in bilingual audio channel. You can record either BIL I or BIL II.

Restrictions on Video Recording

- You cannot record copy-protected video using this DVD Recorder + VCR. Copy-protected video includes DVD-Video discs and some satellite broadcasts. If copy-protected material is encountered during a recording, recording will pause or stop automatically and an error message will be displayed on-screen.

Copyright Notice

- Audio and video recordings you make using the DVD Recorder + VCR are for your personal use only. You may not sell, lend, or rent them to other people.
- This product incorporates copyright protection technology that is protected by U.S. patents and other intellectual property rights owned by Macrovision Corporation and other rights owners. Use of this copyright protection technology must be authorized by Macrovision Corporation, and is intended for home and other limited viewing uses only unless otherwise authorized by Macrovision corporation. Reverse engineering or disassembly is prohibited.

What is DV?

Using DV, also known as i.LINK, you can connect a DV-equipped camcorder to the DVD Recorder + VCR using a single DV cable for input and output of audio, video, data and control signals.

The i.LINK interface is also known as IEEE 1394-1995.

'i.LINK' and the 'i.LINK' logo are trademarks.

- The DVD Recorder + VCR is only compatible with DV-format (DVC-SD) camcorders. Digital satellite tuners and Digital VHS video recorders are not compatible.
- You cannot connect more than one DV camcorder at a time to the DVD Recorder + VCR.
- It may not always be possible to control the connected camcorder via the DV IN jack.
- Audio input to the DV IN jack should be 32 or 48kHz (not 44.1kHz).
- Picture disturbance on the recording may occur if the source component pauses playback or plays an unrecorded section of tape, or if the power fails in the source component, or if the DV cable becomes disconnected.

- Try switching off the HDMI/DVI device and this recorder. Next, switch on the HDMI/DVI device and leave it for around 30 seconds, then switch on this recorder.
- The connected device's video input is set correctly for this unit.
- The connected device is compatible with 720x576i or 720x576p, 1280x720p or 1920x1080i (*i:Interlaced scan mode, p:Progressive scan mode*) video input.

Not all HDCP-compatible DVI devices will work with this recorder.

- It's impossible copy protected-DVD title's playback in non-HDCP devices.

What is USB (Universal Serial Bus)?

USB is an external bus standard that supports data transfer rates of 12 Mbps. A single USB port can be used to connect up to 127 peripheral devices, such as digital cameras, MP3 players, and removable storage. USB also supports Plug-and-Play installation and hot plugging.

- The USB port provides USB 2.0 Full Speed connectivity and also backward compatibility with USB 1.1 (USB 1.0) devices.



- *If you happen to use a bad quality USB cable, the USB device might not be recognized.*
- *The compatibility with MP3 players and digital still cameras is somewhat restricted.*
 - *This DVD Recorder + VCR can playback only mp3 format contents.*
 - *This DVD Recorder + VCR does not support the audio contents encrypted by DRM (Digital Right Management).*
- *Either USB hub device or hub extension connectivity is not supported.*
- *There are awfully lots of kinds of USB devices. Some of the USB devices mentioned above might not be compatible with this DVD Recorder + VCR. In other words, the USB host function of this product does not guarantee the compatibility with all of USB devices.*
- *This DVD Recorder + VCR supports both the high and full speed USB devices (Does not support Low speed devices).*

About HDMI

HDMI (High Definition Multimedia Interface) supports both video and audio on a single digital connection for use with DVD Players, Set-Top Boxes, and other AV devices. HDMI was developed to provide the technologies of HDCP (High Definition Contents Protection). HDCP is used to protect digital content transmitted and received.

HDMI has the capability to support standard, enhanced, or high-definition video plus standard to multi-channel surround-sound audio. HDMI features include uncompressed digital video, a bandwidth of up to 5 gigabytes per second, one connector (instead of several cables and connectors), and communication between the AV source and AV devices such as DTVs.

HDMI, the HDMI logo and High-Definition Multimedia Interface are trademarks or registered trademarks of HDMI licensing LLC.

Additional Information for HDMI

When you connect a HDMI or DVI compatible device make sure of the followings:

Precautions

Handling the Unit

When shipping the unit

The original shipping carton and packing materials come in handy. For maximum protection, re-pack the unit as it was originally packaged at the factory.

When setting up the unit

The picture and sound of a nearby TV, VCR, or radio may be distorted during playback. In this case, position the unit away from the TV, VCR, or radio, or turn off the unit after removing the disc.

To keep the surface clean

Do not use volatile liquids, such as insecticide spray, near the unit. Do not leave rubber or plastic products in contact with the unit for a long period of time. They will leave marks on the surface.

Cleaning the Unit

To clean the cabinet

Use a soft, dry cloth. If the surfaces are extremely dirty, use a soft cloth lightly moistened with a mild detergent solution. Do not use strong solvents such as alcohol, benzene, or thinners, as these might damage the surface of the unit.

To obtain a clear picture

The DVD Recorder + VCR is a high-tech, precision device. If the optical pick-up lens and disc drive parts are dirty or worn, the picture quality will be poor. Regular inspection and maintenance are recommended after every 1,000 hours of use. (This depends on the operating environment.) For details, please contact your nearest dealer.

Remote Control Operation Range

Point the remote control at the remote sensor and press the buttons.

Distance: Within 23 ft (7 m) of the remote sensor.

Angle: Within 30° in each direction of the remote sensor.

Remote Control Battery Installation

Detach the battery cover on the rear of the remote control, and insert two AAA batteries. Make sure the polarities (+ and -) are aligned correctly.

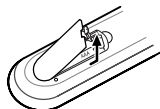

Make sure the polarities (+ and -) are aligned correctly.



Caution

Do not mix old and new batteries. Never mix different types of batteries (standard, alkaline, etc.).

Notes on Discs

Handling Discs

Do not touch the playback side of the disc. Hold the disc by the edges so that fingerprints will not get on the surface. Do not stick paper or tape on the disc.

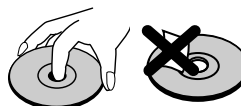

Storing Discs

After playing, store the disc in its case.

Do not expose the disc to direct sunlight or sources of heat, or leave it in a parked car exposed to direct sunlight, as there may be a considerable temperature increase inside the car, which could distort the disc.

Cleaning Discs

Fingerprints and dust on the disc can cause poor picture quality and sound distortion. Before playing, clean the disc with a clean cloth. Wipe the disc from the center outward.

Do not use strong solvents such as alcohol, benzene, thinners, commercially available cleaners, or anti-static spray intended for older vinyl records.

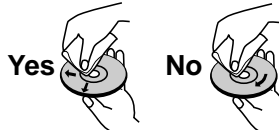

Identification of Controls

Front Panel

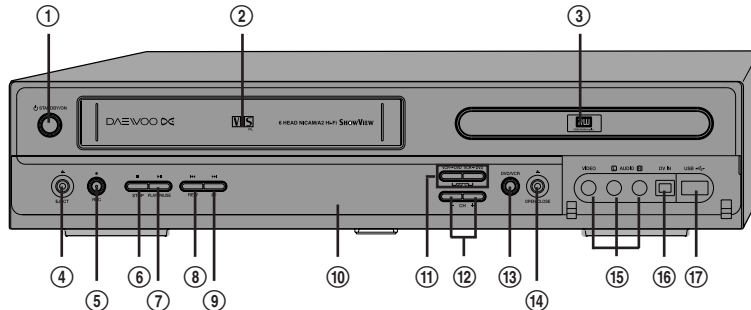

- ① **STANDBY/ON**
Turns the DVD Recorder + VCR on and off.
- ② **Cassette Compartment (VCR deck)**
Insert a video cassette here.
- ③ **Disc Tray (DVD deck)**
Insert a disc here.
- ④ **VCR EJECT**
Ejects the tape in the VCR deck.
- ⑤ **REC**
Starts recording. Press repeatedly to set the recording time.
- ⑥ **STOP**
Stops playback or recording.
- ⑦ **PLAY/PAUSE**
Starts playback of a disc or tape. Pauses playback or recording temporarily.
- ⑧ **REW**
DVD: Skips to previous chapter.
VCR: Rewinds the tape during Stop mode. Press during Play mode for fast reverse picture search.
- ⑨ **FF**
DVD: Skips to next chapter.
VCR: Advances the tape during Stop mode. Press during Play mode for fast forward picture search.
- ⑩ **Front Panel Display**
Shows the current status of the DVD Recorder + VCR.
- ⑪ **COPY**
Copies from DVD to VCR (or from VCR to DVD).
- ⑫ **PR+/-**
Scans up or down through memorized channels. Also moves up and down in menus.
- ⑬ **SELECT DVD/VCR**
Toggles control between the DVD mode and the VCR mode.
- ⑭ **OPEN/CLOSE (DVD)**
Opens or closes the disc tray.
- ⑮ **AVF Input (VIDEO, L-AUDIO-R)**
Connects to the audio/video output of an external source (VCR, Camcorder, etc.).
- ⑯ **DV Input**
Connects to the DV output of an external source (VCR, Camcorder, etc.).
- ⑰ **USB Input**
Connects to the USB device with Flash memory.

Front Panel Display

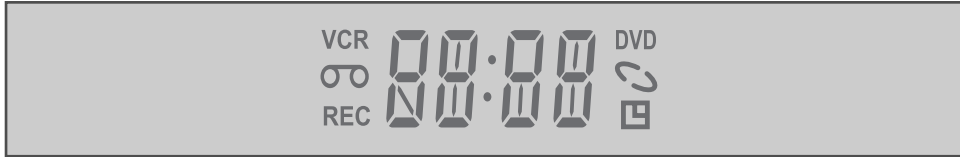

Channel

PR23 TV Channel

Input mode

AV-1 AV1 input

AV-2 AV2 input

F-AV Front - AV input

DV DV input

Copy

COPY DVD to VCR copying

COPY VCR to DVD copying

Recording on disc

11:15 Indicates a DVD Timer recording is set.

11:15 Indicates a DVD Timer Recording is in standby mode.

REC Indicates the DVD is recording.

0:30 OTR Recording mode

RECP Recording Pause mode

Recording on tape

11:15 Indicates a VCR Timer Recording is set.

11:15 Indicates a VCR Timer Recording is in standby mode.

REC Indicates the VCR is recording.

0:30 OTR Recording mode

RECP Recording Pause mode

Others

SAFE Indicates when the DVD Recorder+VCR is locked.

VCR Indicates the DVD Recorder+VCR is in VCR mode (set by [TV/VCR] button).





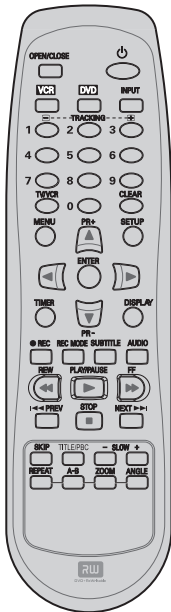



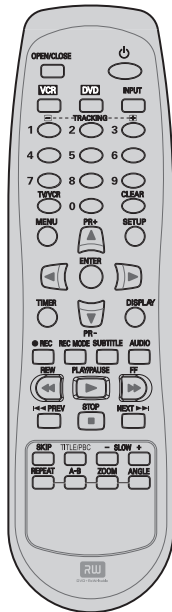

TV Indicates the DVD Recorder+VCR is in TV mode (set by [TV/VCR] button).

Remote Control



	Turns the DVD Recorder+VCR on and off.
	- Opens and closes the disc tray in DVD mode. - Ejects the tape in the VCR deck in VCR mode.
	Selects VCR mode.
	Selects DVD mode.
	Switches the DVD Recorder+VCR input to TV tuner, AV1, AV2, FAV or DV.
	- Selects numbered options in menus.
	- Selects TV channels.
	- Manually adjusts tracking.
	Switches between the DVD Recorder+VCR tuner and your TV tuner.
	Resets the tape counter in VCR mode.
	Accesses DVD disc menus.
	Displays or exits the Setup menu.
	Displays the Timer Recording menu.
	Displays information about the currently loaded disc, VHS tape, or TV channel.
	- : Selects menu options. - PR(+/-) : Selects channels.
	Confirms menu selections.
	Starts recording. Press repeatedly to set the recording time. For more details, Refer to One Touch Record (OTR) on page 45.
	Selects Recording mode: - DVD : Approx 1 Hour (HQ mode), 2 Hours (SP mode), 4 Hours (EP mode), 8 Hours (SEP mode) - VCR : SP or LP.
	Selects a subtitle language, if available.
	Selects an audio language (DVD), audio channel (CD) or audio type (TV).
	- Starts playback. - Pauses playback or recording temporarily. Press again to exit Pause mode.



- 
 - DVD: Searches backward/forward.
 - VCR: Rewinds/advances during Stop mode. Press during Play mode for fast reverse/forward picture search.
- 
 Stops playback or recording.
- 
 Skips to the next or previous chapter/track.
- 
 Commercial Skip skips forward 30 seconds.
- 
 Displays a disc's Title menu, if available.
- 
 Increases or decreases the slow motion speed when playing a DVD or VHS tape.
- 
 Repeats the current chapter, track, title or the entire disc.
- 
 Repeats playback between two points (A and B).
- 
 Enlarges the DVD video image.
- 
 Selects a DVD camera angle, if available.

Progressive Scan Mode

- If your TV supports Progressive Scan, you can view high quality video by setting the DVD Recorder+VCR to Progressive Scan mode. If your TV does not support Progressive Scan, do NOT change to Progressive Scan mode.
- When video output mode is changed from RGB to Interlace or Progressive (Scart 1) will not be correct colour for Component video.
- As component outputs have their own Jacks on the back side, change the TV input into Component input, after connecting the component cables from the DVD Recorder+VCR to TV.
- Changing from Interlace or Progressive to RGB, should be the opposite of above.

CONSUMERS SHOULD NOTE THAT NOT ALL HIGH DEFINITION TELEVISION SETS ARE FULLY COMPATIBLE WITH THIS PRODUCT AND MAY CAUSE ARTIFACTS TO BE DISPLAYED IN THE PICTURE. IN CASE OF 525 PROGRESSIVE SCAN PICTURE PROBLEMS, IT IS RECOMMENDED THAT THE USER SWITCH THE CONNECTION TO THE 'STANDARD DEFINITION' OUTPUT. IF THERE ARE QUESTIONS REGARDING OUR TV SET COMPATIBILITY WITH THIS DVD PLAYER, PLEASE CONTACT OUR CUSTOMER SERVICE CENTRE.

Rear panel

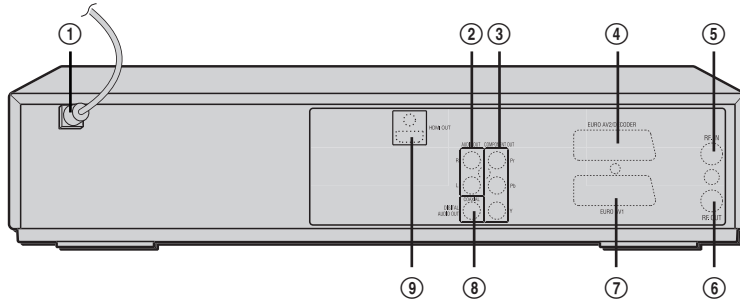

- | | |
|---|---|
| <p>① AC Power Cord
Plug into a power outlet.</p> <p>② AUDIO OUT (L, R)
Connect to a TV or other equipment with audio inputs.</p> <p>③ COMPONENT VIDEO OUT (Y Pb Pr)
Connect to a TV with Component Video (Y Pb Pr) inputs.</p> <p>④ Scart socket 2
Connection of an additional device (satellite receiver, set-top box, video recorder, camcorder, etc.)</p> <p>⑤ RF IN (FROM ANT.)
Connect to your antenna or cable TV outlet.</p> <p>⑥ RF OUT (TO TV)
Connect to a TV with an RF input.</p> | <p>⑦ Scart socket 1
Connection of a TV set. Composite-output and RGB-output</p> <p>⑧ COAXIAL (Digital Audio Out)
Connect to an amplifier with a coaxial digital audio input.</p> <p>⑨ HDMI OUT
HDMI output providing a high quality interface for digital audio and video.</p> <p> Caution</p> <ul style="list-style-type: none"> Do not touch the inner pins of the jacks on the rear panel. Electrostatic discharge may cause permanent damage to the DVD Recorder + VCR. |
|---|---|

Connections

Connecting Antenna/Cable

To enable you to set up your new DVD recorder+VCR, it must be connected it to your TV using either a SCART cable or a COMPONENT and associated AUDIO cable.

- There are a variety of ways to connect the DVD Recorder + VCR to your TV and other equipment. Use only one of the connections described below. Whichever TV connection you use will work with all input sources.
- Please refer to the manuals for your TV, VCR, stereo system, or other devices as necessary to make the best connections.
- For better sound reproduction, connect the DVD Recorder + VCR's AUDIO OUT jacks to the audio in jacks of your amplifier, receiver, stereo, or audio/video equipment. See "Connecting an Amplifier/Receiver" on page 17.

- Caution**
- Make sure the DVD Recorder + VCR is connected directly to the TV, and the TV is set to the correct video input.
 - Do not connect the DVD Recorder + VCR's AUDIO OUT jack to the phone in jack (record deck) of your audio system.
 - Do not connect the DVD Recorder + VCR via your VCR. The DVD image could be distorted by the copy protection system.

- 1 Disconnect the antenna/cable from the rear of your TV.
- 2 Connect this cable to the jack marked RF IN (FROM ANT.) on the rear panel of the DVD Recorder + VCR.

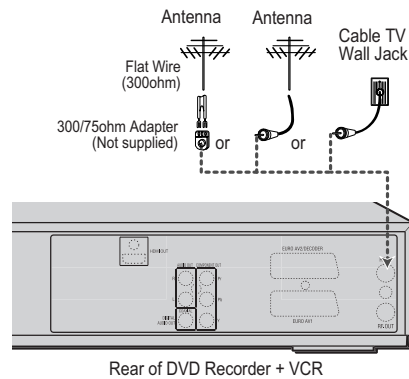

If your cable wire is connected to your TV without a converter or descrambler box, unscrew the wire from your TV and attach it to the RF IN (FROM ANT.) jack on the rear panel of the DVD Recorder + VCR.

Use the supplied RF cable to connect between the DVD Recorder + VCR's OUT (TO TV) jack and the antenna input jack on your TV. With this connection, you can receive all midband, superband, and hyperband channels (all cable channels).

Connecting a TV

Choose one of the following TV connections, depending on the capabilities of your equipment.

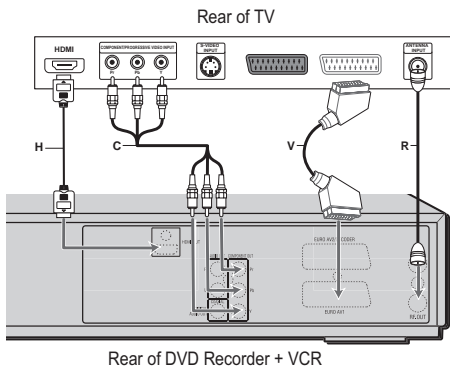

RF Connection

Connect the RF OUT (TO TV) jack on the DVD Recorder + VCR to the antenna in jack on your TV using the supplied 75-ohm RF cable (R).

i This set doesn't have a modulator output. However it still applies the RF through Output.

Scart Connection

- 1 Plug a scart cable into the scart socket EURO AV1 at the back of the DVD Recorder + VCR and the corresponding scart socket at the back of the TV set. (V)
- 2 Plug a scart cable into the blue scart socket EURO AV2/DECODER at the back of the DVD Recorder+VCR and the corresponding scart socket at the back of a satellite decoder or set top box.

Component Video Connection

- If your television is a high-definition or 'digital ready' television, you may take advantage of the DVD Recorder + VCR's Progressive Scan output for the highest video resolution possible.
 - If your TV does not accept the Progressive Scan format, the picture will appear scrambled.
- 1 Connect the COMPONENT VIDEO OUT jacks on the DVD Recorder + VCR to the corresponding in jacks on your TV using a Y Pb Pr cable (C) if the

component (Y, Pb, Pr) is available on your TV.

- 2 Connect the Left and Right AUDIO OUT jacks from the DVD Recorder + VCR to the left/right audio in jacks on your TV using the audio cables.



- Be sure to set the DVD Recorder + VCR to Progressive Scan mode by changing the 'Video Output' in the Setup Menu; see page 24.
- Progressive Scan does not work with the RF or Audio/Video connections.

HDMI connection

If you have a HDMI TV or monitor, you can connect it to this recorder using a HDMI cable.

- 1 Connect the HDMI jack on the recorder to the HDMI jack on a HDMI compatible TV or monitor (H).
- 2 Set the TV's source to HDMI (refer to TV's Owner's manual).



- When you use the HDMI connection, the audio's sampling frequency is outputted only with 48KHz even if you select [96KHz].
- This recorder does not perform internal (2 channel) decoding of a DTS sound track. To enjoy DTS multi channel surround, you must connect this recorder to a DTS compatible receiver via one of this recorder's digital audio outputs.
- No sound will be outputted from HDMI cable if the Digital out option is not set to 'PCM' on the Setup menu (See page 25).
- The arrow on the cable connector body should face up for correct alignment with the connector on the recorder.
- If there is noise or lines on the screen, please check the HDMI cable.
- When you use HDMI connection, you can change the resolution (576i, 576p, 720p, 1080i) for the HDMI output by setting the video output option in setup menu. (see page 24)
 - RGB, Interlaced mode : 576i
 - Interlaced mode : 576i, 1080i
 - Progressive mode : 576p, 720p
- Changing the Progressive Scan mode when the recorder is connected with HDMI connector may result in malfunctions. To solve the problem, turn off the recorder and then turn it on again.

Connecting an Amplifier / Receiver

Connecting to an amplifier equipped with two channel analog stereo or Dolby Pro Logic II/Pro Logic

Connect the Left and Right AUDIO OUT jacks on the DVD Recorder + VCR to the left and right audio in jacks on your amplifier, receiver, or stereo system, using the supplied audio cables (A).

Connecting to an amplifier equipped with two channel digital stereo (PCM) or to an Audio/Video receiver equipped with a multi-channel decoder (Dolby Digital™, MPEG 2, or DTS)

- 1 Connect the DVD Recorder + VCR's DIGITAL AUDIO OUT jack (Coaxial) to the corresponding in jack on your amplifier. Use an optional digital coaxial audio cable. (X)
- 2 You will need to activate the DVD Recorder + VCR's digital output; see 'Audio' Settings on page 25.

Digital Multi-Channel Sound?

A digital multi-channel connection provides the best sound quality. For this you need a multi-channel audio/video receiver that supports one or more of the audio formats provided by your DVD Recorder + VCR (MPEG 2, Dolby Digital, and DTS). Check the receiver manual and the logos on the front of the receiver.



• Due to the DTS Licensing agreement, the digital output will be in DTS digital out when the DTS audio stream is selected.



- If the audio format of the digital output does not match the capabilities of your receiver, the receiver will produce a strong, distorted sound or no sound at all.
- 5.1 channel digital surround sound via the digital connection can only be obtained if your receiver is equipped with a digital multi-channel decoder.
- To see the audio format of the current DVD on the on-screen display, press [AUDIO].

The DVD Recorder + VCR does not perform μ (2-channel) decoding of DTS sound tracks. To enjoy DTS multi-channel surround, you must connect the DVD Recorder + VCR to a DTS compatible receiver via one of the DVD Recorder + VCR's digital audio outputs.

CONNECTIONS

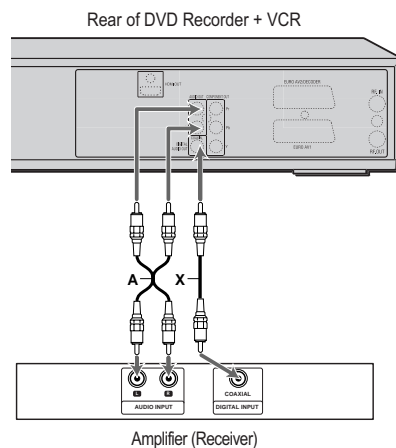

Connecting Optional Equipment

To receive audio/video signals from other equipment, connect the AVF (Audio/Video Front) jacks on the DVD Recorder + VCR to the audio/video out jacks on your external component, using optional audio/video cables.

Jack Panel of Accessory Component (VCR, Analog Camcorder, etc.)

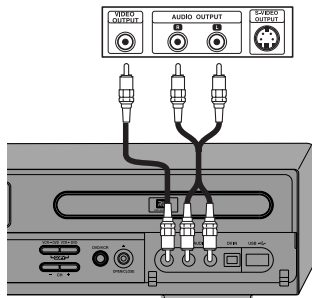

Front of DVD Recorder + VCR

Connecting a Digital Camcorder

Using the front panel DV IN jack, it is possible to connect a DV digital camcorder, video deck or DVD+R/RW recorder and digitally transfer DV tapes or DVD+R/RW discs to DVD+R, DVD+RW.

Use a DV cable (not supplied) to connect the DV In/Out jack of your DV camcorder/video deck to the front panel DV IN jack of the DVD Recorder + VCR.

 This jack is for connection to DV equipment only. It is not compatible with digital satellite tuners or D-VHS video decks.

DV Digital Camcorder

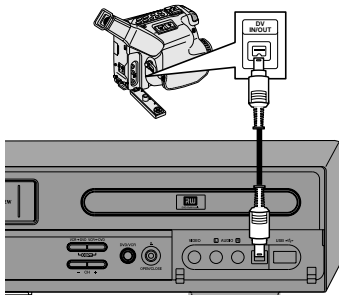

Front of DVD Recorder + VCR

Connecting a Removal Storage

Using the front panel USB IN jack, it is possible to connect a digital Camera or MP3 Player.

Use a USB cable (not supplied) to connect the USB In/Out jack of your Digital Camera or mp3 player to the front panel USB IN jack of the DVD Recorder + VCR.



- Only MP3 Player (or Digital Camera) which doesn't need to install Driver software are available for this DVD Recorder + VCR.
- It is impossible to copy the JPEG or mp3 file in Digital camera or mp3 player to DVD or VCR.

MP3 Player or Digital Camera

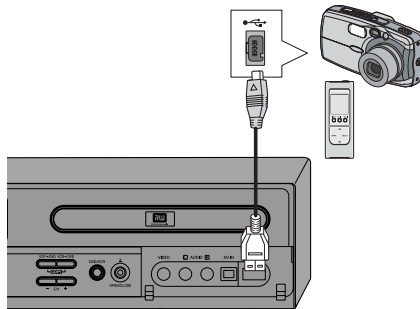

Front of DVD Recorder + VCR

Initial Installation

After successfully connecting your DVD Recorder + VCR to your TV and other devices, this chapter will show you how to complete the initial installation.

 You must follow the initial installation process to set the time, date, channels, and language preferences for the DVD Recorder + VCR.

- 1 A 'Welcome' message is displayed on the screen. Make sure the RF cable from your antenna or cable TV jack is connected. Press [ENTER] to begin initial installation.
- 2 Select the desired language for the on-screen menu using [▲ ▼]. Press [ENTER] to confirm.
- 3 Select the desired country using [▲ ▼]. Press [ENTER] to confirm.

- 4 The DVD Recorder + VCR detects channels automatically and stores them in memory.

- 5 After finishing Auto Channel Search, adjust channels. You can move up, move down, delete and edit channels.

Press [◀] to select 'Move Up', 'Move Down', 'Delete' or 'Edit' while a channel is selected.

If you press [ENTER] while 'Move Up' or 'Move Down' is selected, the channel's order will move up or down.

If you want to delete the channel, press [ENTER] while 'Delete' is selected.

When you want to edit the channel, press [ENTER] while 'Edit' is selected. Keyboard screen will appear. To enter characters, see page 31~32.

- 6 Set the clock after adjusting channels.

Use [◀▶] to move left/right and use [▲ ▼] to change the settings.

- 7 After setting the clock, press [ENTER] to confirm. If you cancel the process during Initial Installation, you should repeat this procedure.

Re-Installation

This set is equipped with the multi-tuner for receiving many countries' broadcasting. In order to receive broadcasting of different countries, follow as below.

- 1 Press [SETUP] and select the 'Restore Defaults' using [◀▶]. Then, RESET the set. (see page 29)
- 2 Power On, then you see the 'Initial Installation'.
- 3 Select the country which you want to (see step 3), then repeat the steps 4~7.

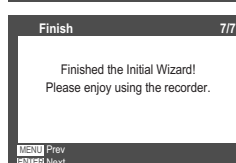
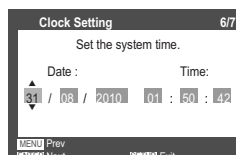
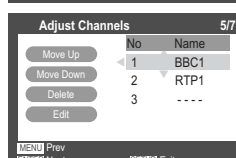
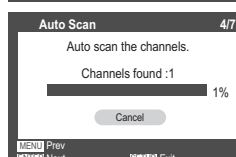
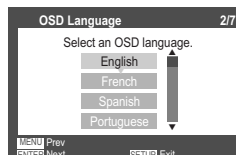
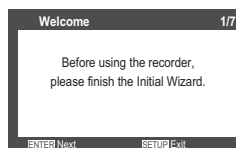

CONNECTIONS

SETUP

Setup menu

Setup Menu Overview

The DVD Recorder + VCR Setup menu includes six categories, including: Installation, Recording Options, Languages, Preference, System Info and Disc Options. Press [SETUP] and [▲▼] on the remote control unit to view the first and second levels of the Setup menu.

Menu Navigation

- 1 Press [SETUP]. The Setup menu appears.
- 2 Use [▲▼] to select the desired category.
- 3 While the desired category is selected, press [▶] to move to the second level.
- 4 Press [ENTER] to move to the third level.
- 5 Use [▲▼] to select the desired setting, then press [ENTER] to confirm your selection. Some items require additional steps. Press [MENU] at any time to return to the previous menu.
- 6 Press [SETUP] to exit the Setup menu.

INSTALLATION Settings

Manual Set

To complete the set-up of your DVD Recorder + VCR when the auto set has not stored all of the channels or when you wish to store a new channel.

- 1 Press [SETUP]. The Setup menu appears.
- 2 Use [▲▼] to select 'Installation' and press [ENTER] to confirm.
- 3 While 'Installation' is selected, press [▲▼] to select 'Manual Set'.

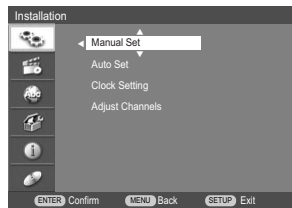

- 4 Press [ENTER]. The 'Manual Set' menu appears.
- 5 Use [▲▼] to select 'Standard'.

■ 20 ■

- 6 Use [◀▶] to select the desired 'Standard' (PAL-BG, PAL-II, PAL-DK, or SECAM-L).

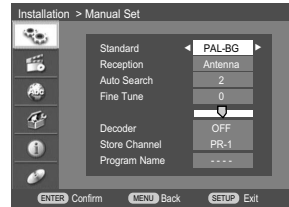

This set is equipped with the Multi-Tuner. You can search broadcasting of other countries. If the set can not search the channels, please Re-Install. (see page 19.)

- 7 Use [▲▼] to select 'Reception'.
- 8 Use [◀▶] to select the desired broadcast system (Antenna or Cable).

Antenna: If you are using a standard antenna to receive channels.

Cable TV: If you are using basic cable to receive channels.

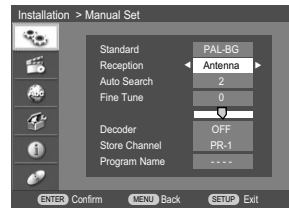

- 9 Use [▲▼] to select 'Auto Search'.
- 10 Search the real channel number by pressing [◀▶].

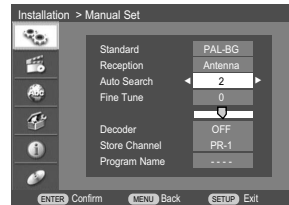

- 11 Select 'Fine Tune'. You can adjust the fine tuning.

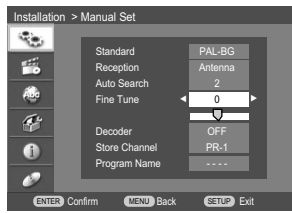

- 12 Use [▲ ▼] to select 'Decoder'.
- 13 When the program is encoded (and you have a decoder connected to socket EURO AV2), press [◀ ▶] to select 'On'.

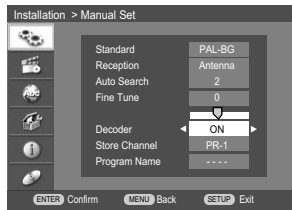

- 14 Use [▲ ▼] to select 'Store Channel'.
- 15 Use [◀ ▶] to select program number to store.

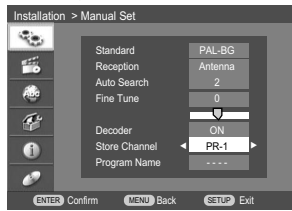

- 16 Use [▲ ▼] to select 'Program Name'. Press [▶] to move to the second level. If your DVD Recorder + VCR is showing no station name or is showing a station name incorrectly, you can correct this.
- 17 Keyboard screen will appear when you press [▶] to move to the second level.

You can create the station name and enter 4 digit name.

To enter characters, see page 31~32.



- 18 After adjusting all items, move cursor to 'Store Channel' using [▲ ▼].
- 19 Press [ENTER] to store settings.

Auto Set

The DVD Recorder + VCR has a frequency synthesized tuner capable of receiving channels that include VHF Low E2~S6, VHF High S7~S36, and UHF S37~E69.

Preparation:

Connect the DVD Recorder + VCR to the desired type of antenna or cable TV system, as shown in 'Connecting Antenna/Cable' on page 15.

- 1 Press [SETUP]. The Setup menu appears.
- 2 Use [▲ ▼] to select 'Installation'.
- 3 While 'Installation' is selected, press [▶] or [ENTER] to select 'Auto Set'.

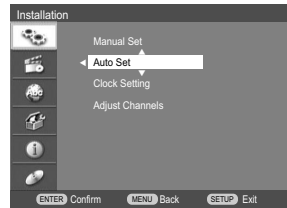

- 4 Press [ENTER] to begin the channel search. The tuner will automatically search for all available channels in your area and place them in the tuner's memory.

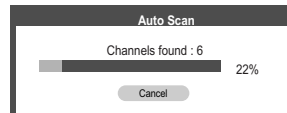

i After Auto Set is complete, follow the instructions above to make sure that Tuning Band is set correctly.

Clock Setting

- 1 Follow steps 1-2 as shown under 'Manual Set'.
- 2 Use [▲▼] to select 'Clock Setting'.

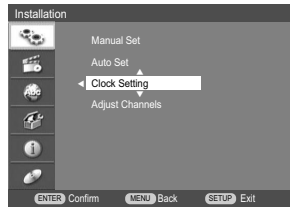

- 3 Press [ENTER]. The 'Clock Setting' menu appears.

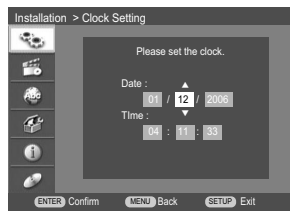

- 4 Enter the date and time.
 - ◀ ▶ (left/right): Moves the cursor to the previous or next column.
 - ▲ ▼ (up/down): Changes the setting at the current cursor position.
- 5 Press [ENTER] to confirm your setting, then press [SETUP] to exit the Setup menu.

Adjust Channels

- 1 Follow steps 1-2 as shown under 'Manual Set'.
- 2 Use [▲▼] to select 'Adjust Channels'.

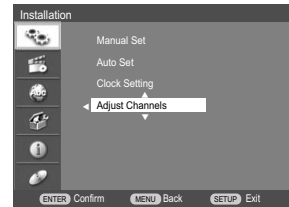

- 3 Press [ENTER]. The Adjust Channels menu appears.
- 4 Use [▲▼] to select the PR number you want to adjust. Then press [ENTER].

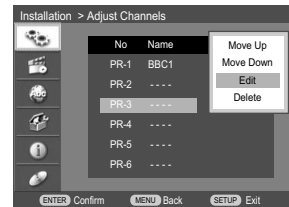

Move Up/Down

After tuning TV stations into your DVD Recorder + VCR, you may wish to change the order of PR's you have in your set, as your preference.

- 1 Use [▲▼] to select 'Move Up' (or 'Move Down') and press [ENTER].
- 2 The selected PR will be moved up or moved down.

Edit

After tuning TV stations into your DVD Recorder + VCR, you may wish to put a name (4 digits) into any channel you want to.

- 1 Use [▲▼] to select 'Edit' and press [ENTER].
- 2 Keyboard screen will appear. To enter characters, see page 31~32.

Delete

After tuning TV stations into your DVD Recorder + VCR, you may wish to delete a station.

- 1 Use [▲▼] to select 'Delete' and press [ENTER].

RECORDING Options Settings

VCR Record Quality

You can set the default VCR recording quality to SP (Standard Play) or LP (Long Play). SP is higher quality, but LP provides 2 times the recording time; e.g., a 2 hour tape will record for 4 hours in LP mode.

- 1 Press [SETUP]. The Setup menu appears.
- 2 Use [▲ ▼] to select 'Recording'.
- 3 While 'Recording' is selected, press [▶] to select 'VCR Quality'.
- 4 Press [ENTER] to move to the second level.
- 5 Use [▲ ▼] to select the desired Record Quality (SP or LP).
- 6 Press [ENTER] to confirm your selection, then press [SETUP] to exit the menu.

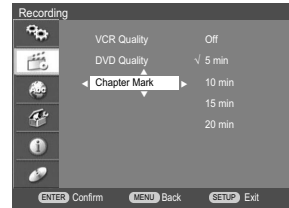

DVD Record Quality

You can set the default DVD recording quality to: HQ (High Quality - 1 hr/disc), SP (Standard Quality - 2 hrs/disc), EP (Extended Play - 4 hrs/disc) or SEP (Very Low Quality - 8 hrs/disc).

Follow the same procedure as the 'VCR Record Quality'.



Chapter Mark

During recording, chapter markers are added automatically at fixed intervals.

You can set this interval to 5 minutes, 10 minutes, 15 minutes or 20 minutes.

To turn off automatic chapter marking, select 'Off'.

Follow the same procedure as the 'VCR Record Quality'.

LANGUAGE Settings

OSD Language

Select a language for the DVD Recorder + VCR Setup menu and on-screen displays.

- 1 Press [SETUP]. The Setup menu appears.
- 2 Use [▲ ▼] to select 'Language'.
- 3 While 'Language' is selected, press [▶] to select 'OSD Language'.
- 4 Press [ENTER] to move to the second level.
- 5 Use [▲ ▼] to select the desired language.
- 6 Press [ENTER] to confirm your selection, then press [SETUP] to exit the menu.



Menu/Subtitle/Audio Language

Select your preferred language for Disc Menus, Subtitles, and Audio soundtracks.

Follow the same procedure as the OSD Language.

Default : The disc's default language is selected.

Preference > Video Setting

- 1 Press [SETUP].
- 2 Use [◀▶] to select 'Preference'.
- 3 While 'Preference' is selected, press [▶] to select 'Video'.
- 4 Press [ENTER]. The 'Video' submenu is displayed.

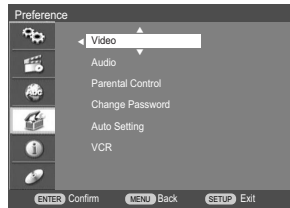

TV Aspect Ratio

- 1 Use [ENTER] to select 'TV Aspect' while the 'Video' submenu is displayed.
- 2 Press [ENTER] or [▶] to go to the second level.
- 3 Use [▲▼] to select the desired 'TV Aspect'.

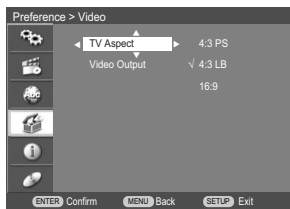

- 4 Press [ENTER] to confirm your selection.
- 5 Press [SETUP] to exit the menu.

4:3 LB : Select when a standard 4:3 TV is connected. Displays theatrical images with masking bars above and below the picture. The default TV screen is set to 4:3 LB.

4:3 PS : Select when a standard 4:3 TV is connected. Displays pictures cropped to fill your TV screen. Both sides of the picture are cut off.

16:9 : Select when a 16:9 wide screen TV is connected.

Video Output

The default video output is set to 576i (interlaced scan mode).

RGB 576i : Only if the DVD Recorder + VCR is in RGB interlace mode, you can watch RGB signal with connecting the recorder to analog television using the SCART jacks.

Interlace (576i, 1080i) or Progressive (576p, 720p) : If you connect the DVD Recorder + VCR to a digital television (DTV) or Monitor using the COMPONENT jacks, set Video Output to '576i', '576p', '1080i' or '720p' (i : Interlaced scan mode, p : Progressive scan mode).

Follow the same procedure as 'TV Aspect' to change the 'Video Output'.



i When you use HDMI connection, you can change the resolution (576i, 675p, 720p, 1080i) for the HDMI output by setting the video output option in setup menu.

But if you use COMPONENT VIDEO connection, you can see only 576p in the case of 720p or 1080i.

Preference > Audio Setting

Follow the same procedure as 'Video' Settings to select 'Audio' Settings.

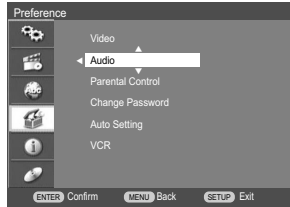

Digital Output

- 1 Use [ENTER] to select 'Digital Output' while the 'Audio' submenu is displayed.
- 2 Press [ENTER] or [▶] to go to the second level.
- 3 Use [▲ ▼] to select the desired digital output type.

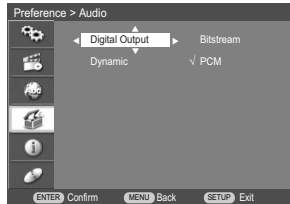

- 4 Press [ENTER] to confirm your selection.
- 5 Press [SETUP] to exit the menu.

Bitstream

Select when connected to a Dolby Digital or DTS decoder (or an amplifier or other equipment with a Dolby Digital or DTS decoder).

PCM

Select when connected to a 2 channel digital stereo amplifier. The DVD Recorder + VCR's digital audio signal will be output in the PCM 2ch format when you play a DVD recorded with a Dolby Digital (only for DVD) or MPEG soundtrack. If the DVD is recorded with a DTS sound track then no sound will be heard.

Dynamic Range

While watching DVD movies, you may wish to compress the dynamic range of the audio output (the difference between the loudest and quietest passages). This allows you to listen to a movie at a lower volume without losing clarity of sound.

Set 'Dynamic' to 'Full', 'Middle' or 'Off' for this effect. Follow the same procedure as 'Digital Output' to set the 'Dynamic'.

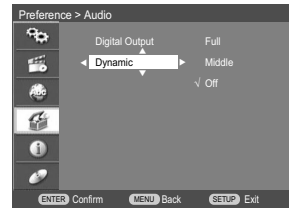

SETUP

Preference > Parental Control

Set Parental Level

The Parental Controls feature allows you to prevent DVDs from being played based on their ratings or to have certain discs played with alternative scenes. You can set the parental level from 'Adult' to 'Kid safe'.

- 1 Press [SETUP].
- 2 Use [▲ ▼] to select 'Preference'.
- 3 While 'Preference' is selected, press [▲ ▼] to select 'Parental Control'. And press [ENTER].

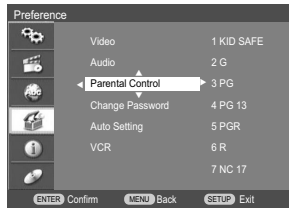

- 4 Use [▲ ▼] to select parental level and press [ENTER].

The Password Input dialog will appear. Enter a 4-digit password using the [0-9] buttons. If this is the first time you have entered a password, you will be prompted to enter the password again to confirm it.

- 5 After setting the password, press [ENTER].

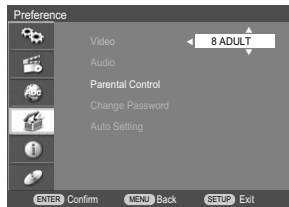

The initial password is '0000'. You must enter this password before you can change the Parental Level.



Set the new password to something other than '0000'.

- 6 Enter your new password.
- 7 Use [▲ ▼] to select the desired parental level and press [ENTER] to confirm.

Adult to Kid safe: Some discs contain scenes not suitable for children. If you set a rating for the DVD Recorder + VCR, all scenes with the same rating or lower will be played. Higher rated scenes will not be played unless an alternative scene is available on the disc. The alternative must have the same rating or a lower one. If no suitable alternative is found, playback will stop. You must enter the 4-digit password or change the rating level in order to play the disc.

- 8 Press [ENTER] to confirm your rating selection, then press [SETUP] to exit the menu.

Preference > Auto Setting

Change Password

- 1 While 'Preference' is selected, press [▲ ▼] to select 'Change Password'.
- 2 Press [ENTER]. The 'Change Password' submenu appears.

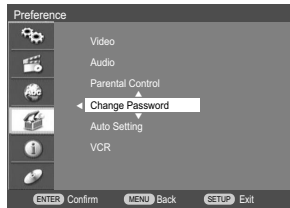

- 3 The 'Change Password' submenu appears. Enter your current 4-digit password.

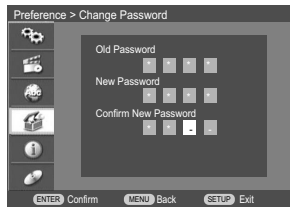

- 4 Enter a new 4-digit password. Re-enter the new password to confirm, press [ENTER].

- **Master Password** : If you forget your password, press 3,3,0,8 on the remote control and then press [ENTER].
- Set the new password to something other than '0000'.

- 1 While 'Preference' is selected, press [▲ ▼] to select 'Auto Setting'.
- 2 Press [ENTER] to display the submenu.

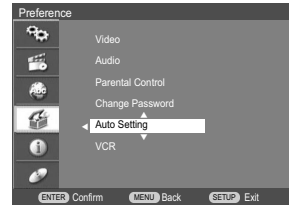

Auto Clock Setting

Auto Clock enables the DVD Recorder + VCR to set the clock automatically whenever it is in Standby mode (plugged in but powered off).

Auto Clock is only available for models with the VPS/PDC function.

Some broadcasting stations may send the time and date along with the VPS/PDC data. The video will automatically use this time and date during the initial setting up procedure during normal use, and every time you switch the video off at the mains. If you find that this time and date is incorrect you can remove this feature by following the steps below changing it to the OFF mode, you will then have to manually set the time and date, see above.

- 1 Use [▲ ▼] to select 'Auto Clock Setting' and press [ENTER].
- 2 Use [▲ ▼] to change the 'Auto Clock Setting' status, and press [ENTER] to confirm.

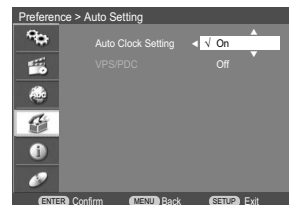

Preference > VCR

VPS/PDC

VPS/PDC is a service provided by some stations to enable you to perform timer recordings precisely even if the broadcaster delays the start time of the program slightly. The time you enter is the VPS/PDC time so this must be correct. Not all stations offer VPS/PDC, in which case the player will start at the time you enter and not the actual start time of the programme.

If you wish to start recording at a specific time with it being adjusted by the VPS/PDC system in the event of a delay, switch VPS/PDC on.

Follow the same procedure as 'Auto Clock Setting' to set the 'VPS/PDC' status.

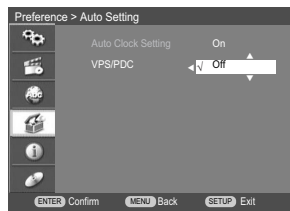

"VPS/PDC" and "Auto Clock Set" are not provided for some countries.

This feature enables you to search for Index marks or specific times on your VHS tapes.

- 1 While 'Preference' is selected, press [▼] to select 'VCR'.
- 2 Press [ENTER].
- 3 The 'VCR' submenu is displayed.
- 4 Select 'Index+', 'Index-' or 'Go To Zero'.

If you select 'Index+' (or 'Index-') and press [ENTER], your DVD Recorder+VCR will locate your index mark and begin playback.

If you select 'Go To Zero' and press [ENTER], your DVD Recorder+VCR will wind to the position 0:00:00 and stop.

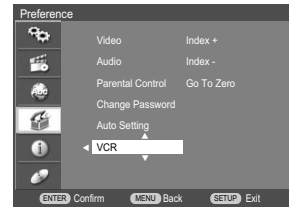

The VCR menu is activated only when a video cassette tape is inserted and DVD Recorder+VCR is in VCR mode.

System > System Info

'System Info' helps service personnel identify key firmware information about your DVD Recorder + VCR in case service is required.



System > DivX(R) VOD DRM

We provide you the DivX® VOD (Video On Demand) registration code that allows you to rent and purchase videos using the DivX® VOD service. For more information, visit www.divx.com/vod.



System > Restore Default

If you wish, you can reset the DVD Recorder + VCR to its original factory settings.

- 1 While 'System' is selected, press [▼] to select 'Restore Default'.
- 2 Press [ENTER].
- 3 The 'Restore Default' menu will appear. Use [▲/▼] to select 'OK' and press [ENTER].

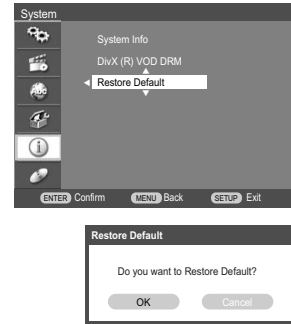

- Some options cannot be reset, including Parental Controls and Password.
- After Restoring Defaults, the unit is powered off automatically. At this time, if you power on again, the Installation menu appears. You must set the country, language, channel, and clock settings again.

SETUP

Disc > Format

If you load a completely blank disc to the DVD Recorder + VCR, the recorder will initialize the disc to DVD+VR mode.

Also, you can reformat the DVD-RW/DVD+RW from the Setup menu as below.



- If you want to change the disc format, everything recorded on the disc will be erased.
- While disc is initialized, the red disc mark appear on TV screen.

- 1 Press [SETUP].
- 2 Use [▲/▼] to select 'Disc'.
- 3 While 'Disc' is selected, press [▲/▼] to select 'Format'. And press [ENTER].
- 4 Press [ENTER] to start formatting the disc.



Disc > Finalize

Finalizing 'fixes' the recordings in place so that the disc can be played on a regular DVD player or computer equipped with a suitable DVD-ROM drive.

Finalizing a Video mode disc creates a menu screen for navigating the disc. This is accessed by pressing [MENU].



- Once you have finalized a DVD-R and DVD+R disc, you cannot edit or record anything else on that disc except DVD+RW. However, you can record and edit a DVD-RW disc by choosing 'Unfinalize' option.

- 1 Press [SETUP].
- 2 Use [▲/▼] to select 'Disc'.
- 3 While 'Disc' is selected, press [▲/▼] to select 'Finalize'. And press [ENTER].
- 4 The Finalize menu will appear. Select 'OK' and press [ENTER].

The recorder starts finalizing the disc.



Disc > Protect

When recording in DVD-RAM / DVD+RW / +R disc or VR mode formatted DVD-RW disc, set to 'Protect' to prevent accidental recording, editing or deleting of the disc loaded. If you need to unlock the disc to make edits, select 'Unprotect'.

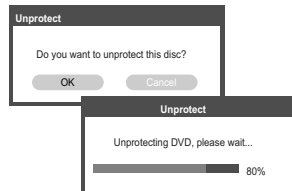
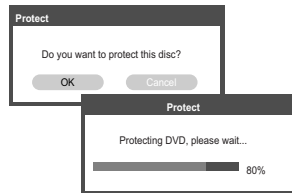
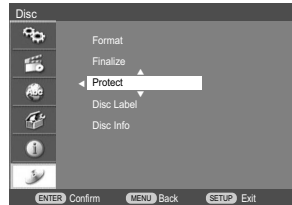

Disc > Disc Label

Use this to enter a name for the disc. This name appears when you load the disc and when you display disc information on-screen.

The disc name can be up to 32 characters long.

For discs formatted on a different recorder, you will see only a limited character set.

- 1 Press [SETUP].
- 2 Use [▲/▼] to select 'Disc'.
- 3 While 'Disc' is selected, press [▲/▼] to select 'Disc Label'. And press [ENTER].



- 4 Keyboard menu appears.

Enter a name for the label. Use [▲▼◀▶] to select a character then press [ENTER] to confirm your selection.

Save : Save a new label after finishing entering characters.

Space : Inserts a space at the cursor position.

Backspace : Deletes the previous character at the cursor position.

Cancel : Cancel the keyboard.

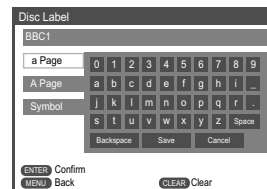

Tip:

Remote control buttons for entering a name

[MENU]: Back to the previous menu.

[CLEAR]: Cancels all entered characters.

[ENTER]: Confirm the character.



*Names can be up to 64 characters long.
For discs formatted on a different recorder, you will see only a limited character set.
When recording on DVD-R, DVD+R or DVD-RW discs, the entered name is displayed on the DVD player only after finalization.*

Disc > Disc Info

Disc Info includes : Label, numbers of titles, media type, status, space, remainder.



On-Screen Display Overview

The On-Screen Display provides feedback on the status of the DVD Recorder + VCR and/or the currently loaded disc or VCR. To access the On-Screen Display (or OSD), press [DISPLAY].

Displaying Disc/VCR Information

To display information about the currently loaded disc or VCR:

Displaying information while watching TV

During viewing the TV, press [DISPLAY] to display/remove the information displayed on-screen.

See the descriptions below for detailed explanations of the on-screen displays for each media type.



Some discs may not provide all the features shown in the on-screen display examples.

Temporary Feedback Icons

⊘ Action prohibited or not available

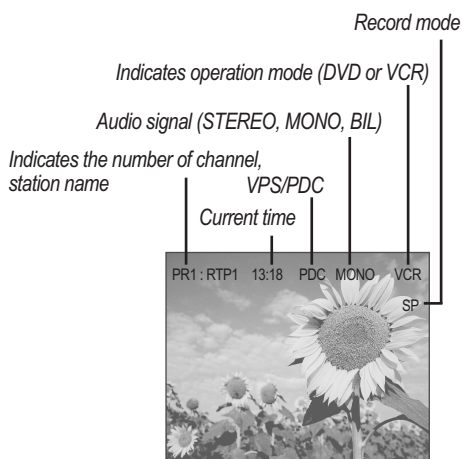

VPS/PDC is provided by some stations. If 'VPS' or 'PDC' appears on the screen, it means the station provides the VPS/PDC service.

Disc Information options for DVD

Title

Shows the current title number and total number of titles, and skips to the desired title number.

- 1 Press [DISPLAY] during playback. The on-screen display appears on the TV screen.
- 2 Use [▲▼] to select the 'Title' icon on the on-screen display.
- 3 Use [◀▶] to change the numbers.

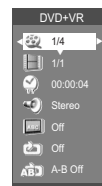

Chapter

Shows the current chapter number and total number of chapters, and skips to the desired chapter number.

- 1 Press [DISPLAY] during playback. The on-screen display appears on the TV screen.
- 2 Use [▲▼] to select the 'Chapter' icon on the on-screen display.
- 3 Use [◀▶] to change the numbers.

Elapsed

Shows the elapsed playing time, and skips to the desired time.

- 1 Press [DISPLAY] during playback. The on-screen display appears on the TV screen.
- 2 Use [▲▼] to select the 'Elapsed' icon on the on-screen display.
- 3 Press [ENTER] to search by time. Use [0~9] to change the numbers.
- 4 Press [ENTER] to confirm the start time. Playback starts from the selected time on the disc.

For the title recorded without DVD navigation information, such as the one from broadcast or line input, 'Elapsed' function does not work.

Audio

Shows selected audio language (DVD VIDEO only) or audio channel (STEREO, MONO, RIGHT or LEFT).

Subtitle

Shows the current subtitle language, and changes the setting.

- 1 Press [DISPLAY] during playback. The on-screen display appears on the TV screen.

SETUP

PLAYBACK

- 2 Use [▲▼] to select the 'Subtitle' icon on the on-screen display.
- 3 Use [◀▶] repeatedly to select desired subtitle language.

Repeat

- 1 Press [DISPLAY] during playback. The on-screen display appears on the TV screen.
- 2 Use [▲▼] to select the 'REPEAT' icon on the on-screen display.
- 3 Use [◀▶] repeatedly to select a desired repeat mode.

[DVD] Title → Chapter → All → Off

[Video CD / Audio CD] Random → Single → Repeat One → Repeat Folder → Off

[MP3] Random → Single → Repeat One → Repeat Folder → Off

A-B Repeat

- 1 Press [DISPLAY] during playback. The on-screen display appears on the TV screen.
- 2 Use [▲▼] to select the 'A-B REPEAT' icon on the on-screen display.
- 3 Use [◀▶] repeatedly to set a desired repeat part.

Changing TV Channels

When DVD Recorder+VCR is in live mode, you can change TV channels using the [0-9] or [PR+/-] buttons on the remote control or [PR+/-] buttons on the front panel.

Changing the TV Audio Channel

You can change the TV audio using the [AUDIO] button.

Press [AUDIO] repeatedly to change the TV audio, according to the Broadcast audio signal as shown below.

- **STEREO Audio Signal**
STEREO → MONO → STEREO
- **BIL Audio Signal**
BIL- I → BIL- II → BIL- I
- **MONO Audio Signal**
MONO

The current audio channel is displayed on-screen.

- If the sound is poor quality when set to Stereo, you can often improve it by changing to Mono.
- When an external input is selected, the audio channel can be switched only to Stereo.

VCR Playback

Before You Begin

- 1 Press the [VCR] button to set the remote control to operate the VCR deck.
- 2 Turn the TV on and select the video input source connected to the DVD Recorder+VCR.
Audio system: Turn the external audio system on and select the input source connected to the DVD Recorder+VCR.

Playing a VHS Tape

1 Insert a prerecorded video cassette.

If the DVD Recorder+VCR is powered off, it will power on automatically.

Make sure the TIMER indicator on the front panel display is not lit. If it is, press [POWER] once.

If a tape without a safety tab is inserted, the DVD Recorder+VCR will start playback automatically.



If the DVD Recorder+VCR is powered on by inserting a video cassette with a safety tab, playback will not start automatically.

2 Press [PLAY].

The PLAY icon appears on the TV screen. It is not necessary to select the tape speed (SP, LP) for playback. It will be automatically selected by the DVD Recorder+VCR.

3 Press [STOP] to stop playback.

The STOP icon appears on the TV screen. If the tape reaches the end before [STOP] is pressed, the DVD Recorder+VCR will automatically stop and rewind.

Tracking Control

Auto Tracking

The automatic tracking function adjusts the picture to remove snow or streaks. It works in the following cases:

- When a tape is played for the first time.
- When the tape speed (SP, LP) changes.
- When streaks or snow appear because of scratches on the tape.

Manual Tracking

If noise appears on the screen during playback, press the [TRACKING +/-] buttons on the remote control until the noise on the screen is reduced.

- If vertical jitter occurs, adjust these controls very carefully.
- Tracking is automatically reset to normal when the tape is ejected or the power cord is unplugged for more than 3 seconds.

PLAYBACK

Special Playback Features



Notes on special playback features (EG: FFW or FBWD)

Horizontal lines (noise bars) will appear on the TV screen. This is normal.

The audio is automatically muted during special playback modes, so there is no sound during search, slow motion, etc.

During high-speed picture search, a short time is needed to stabilize tape speed when re-entering Play mode. Slight interference may be observed during this time.

Fast Forward/Backward

This function lets you visually search forward and backward for a desired scene on your tape.

- 1 Press [REW] or [FF] during playback.

Search mode will be activated.

If the DVD Recorder+VCR is left in Search mode for more than 3 minutes, the DVD Recorder+VCR will automatically resume Play mode to protect the tape and video heads.

- 2 To return to normal playback, press [PLAY].

Still Picture

- 1 Press [PLAY/PAUSE] during playback.

A still picture appears on the TV screen.

If a still picture vibrates vertically, stabilize it by using the [TRACKING +/-] buttons on the remote control.

If the DVD Recorder+VCR is left in still mode for more than 5 minutes, the DVD Recorder+VCR will automatically resume Play mode to protect the tape and video heads.

- 2 To return to normal playback, press [PLAY].

Slow Motion

- 1 Press [SLOW+] for Slow Motion playback.
- 2 Press [SLOW+] and [SLOW-] repeatedly to adjust the Slow Motion playback speed.

Counter Memory Function

This is useful if there is a section of tape you want to view immediately after recording or if you want to return to the same point several times.

- 1 Begin recording or playing a tape.
- 2 At the point you want to locate later, reset the real-time counter to 0:00:00 by pressing [CLEAR]. Continue to play or record.
- 3 Press [STOP] when recording or playback finishes.
- 4 You can make the tape automatically stop when the counter returns to about '0:00:00' by selecting "Go-to-Zero" function under 'SETUP' → 'Preferences' → 'VCR'. See page 28.

DVD Playback

Playing a DVD

- 1 Press [DVD] to set the remote control to operate the DVD.

Turn the TV on and select the video input source connected to the DVD Recorder + VCR.

Audio system: Turn the audio system on and select the input source connected to the DVD Recorder + VCR.

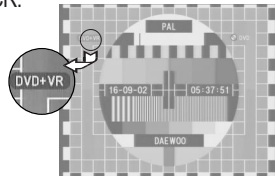

- 2 Press [OPEN/CLOSE] to open the disc tray.
- 3 Load your disc in the tray with the playback side down (label side up).
- 4 Press [OPEN/CLOSE] to close the tray.
- 5 'LOAD' appears on the front panel display, and playback starts automatically (in case of DVD VIDEO and finalized discs).

If playback does not start, press [PLAY (▶)]. In some cases, the Disc menu may appear instead.

Playing a DVD

When a DVD+RW or unfinalised DVD+R/-R/-RW is inserted, no title is played automatically but the current TV channel displays on the screen.

If you want to play a title on the DVD+R (+RW), you must press [MENU] or [PLAY] to display the disc menu. Select a title to play then press [ENTER].

If a Disc menu is displayed

- A Disc menu may be displayed when you load a DVD. Use the [◀▶▶▶] buttons to select the title/chapter you want to view, then press [ENTER] to start playback. Press [MENU] to return to the Disc menu.
- The DVD Recorder + VCR will not play discs with Region codes different from the DVD Recorder + VCR. The Region code for this DVD Recorder + VCR is 2 (two).
- Unless stated otherwise, all operations described below use the remote control. Some features may also be available in the Setup menu.
- A disc which is recorded by computer at high

speeds (greater than or equal to 2x) may not be recognized.

- A disc which is recorded with unauthorized movie material may not be played.
- A disc which is recorded by another recorder or not recorded correctly may not be recognized or played.

Still Picture and Frame-by-Frame Playback

- 1 Press [PLAY/PAUSE] during playback. The DVD Recorder + VCR will go into Still mode.
- 2 You can back up or advance the picture frame-by-frame by pressing [NEXT ▶▶] repeatedly during Still mode.

Fast Forward/Backward

- 1 Press [▶▶▶] or [◀◀◀] during playback. The DVD Recorder + VCR will go into Search mode.
- 2 Press [▶▶▶] or [◀◀◀] to select the desired speed: ▶▶ X2, ▶▶ X4, ▶▶ X8, ▶▶ X16, ▶▶ X32 (forward) or ◀◀ X2, ◀◀ X4, ◀◀ X8, ◀◀ X16, ◀◀ X32 (backward).

Slow Motion

Press [SLOW+] or [SLOW-] to select the desired speed: 1/16, 1/8, 1/4, 1/2 ... (forward), or 1/16, 1/8, 1/4, 1/2 ... (backward).

Changing the Audio Language

Press [AUDIO] and then press [AUDIO] repeatedly during playback to hear a different audio language or audio track.

Subtitles

Press [SUBTITLE] and then press [SUBTITLE] repeatedly during playback to select among all available subtitle languages.

Zoom

The Zoom function allows you to magnify the video image and scroll around the enlarged image.

- 1 Press [ZOOM] during Play mode to activate the Zoom function.
Each press of the [ZOOM] button changes the

Zoom level as follows: x1 (normal size) → x2 → x3 → x4 → x1 (normal size)

- 2 Use the [◀▶▲▼] buttons to scroll around the zoomed picture.
- 3 To resume normal playback, press [ZOOM] repeatedly until the X1 (normal picture) appears.



• The Zoom function may not work on some DVDs (ex. Jpg.)

Repeat

- 1 To repeat the currently playing title, press [REPEAT]. 'Title' appears on the TV screen.
- 2 To repeat the currently playing chapter, press [REPEAT] twice. 'Chapter' appears on the TV screen.
- 3 To repeat the whole disc, press [REPEAT] three times. 'All' appears on the TV screen.
- 4 Each press of the [REPEAT] button changes the repeat mode as follows:
[DVD] Title → Chapter → All → Off
[VCD, SVCD] Track → All → Off
[CDDA, MP3] Random → Single → Repeat One → Repeat Folder → Off

A-B

You can repeat a scene between two points (A and B):

- 1 Press [PLAY/PAUSE] play to the start of the desired scene.
- 2 Press [A-B] to mark the start point.
- 3 Use [◀◀], [▶▶] to search the end point.
- 4 Press [A-B] to mark the end point.
- 5 The marked scenes are repeated continuously until you stop the repeat by pressing [A-B] button again.

Selecting Titles

When a disc has more than one title, you can select among all available titles as follows:

- 1 Press [DISPLAY] and use [▲▼] to select the Title icon.

- 2 Use [◀▶] to select the desired title number.

Selecting Chapters

When a title on a disc has more than one chapter, you can select among all available chapters as follows:

- 1 Press [PREV (◀◀)] or [NEXT (▶▶)] briefly during playback to select the next or previous chapter.
- 2 To skip directly to any chapter during playback, press [DISPLAY].

Use [▲▼] to select the Chapter icon.

Use [◀▶] to select the desired chapter number.

Disc Menu

Many DVDs contain Disc menus that allow you to access special features. To open a Disc menu, press [MENU]. Then use the [▲▼◀▶] buttons to highlight your desired selection and press [ENTER].

- 1 Press [MENU]. The Disc menu is displayed.
- 2 To exit the Disc menu, press [STOP] or [SETUP].

Title Menu

- 1 Press [TITLE/PBC]. If the current title has a menu, the Title menu will appear on the TV screen. Otherwise, the Disc menu may appear.
- 2 The Title menu may contain camera angles, spoken languages and subtitle options, as well as the chapters for the title.

Angle

If a DVD contains scenes recorded at different camera angles, angle icon displays automatically. You can select among these angles during playback.

- 1 Press [ANGLE] and then press it repeatedly during playback to select the desired angle.
- 2 The number of the current angle appears on the TV screen.



The Angle icon is displayed on the TV screen when alternate angles are available.

Playing a Picture, Audio or DivX files

DivX Playback (USB Media, DVD)

The DVD Recorder + VCR can play DivX files on a disc such as CD-R/RW, DVD+R/RW, DVD-R/RW or on USB Media.

- 1 Prior to playing Divx files on disc, insert disc and close the tray.

If you want to playback the files in the Removable Storage, connect it to USB In/Out port on the front panel.

- 2 The Media Browser appears automatically. If it doesn't appear, press [MENU] to bring up the Media Browser and select the media (USB Media, DVD) you want to play.



- **i** Media Browser can be appeared only when you connect a Removable Storage. If not, Disc Media window appears directly.

- 3 Press [ENTER] and select the DivX category using [▲▼], then press [ENTER].

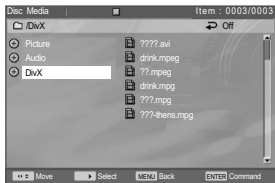

- 4 Use [▶] and [▲▼] to select a file, then press [ENTER].

You could see the third menu when you press [ENTER] on the selected files.

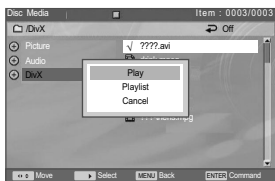

Play : play the selected file.

Playlist : add the selected file to playlist.

Cancel : cancel the third menu.

- 5 If you want to add a file to the playlist, press [▶] while the file is selected.

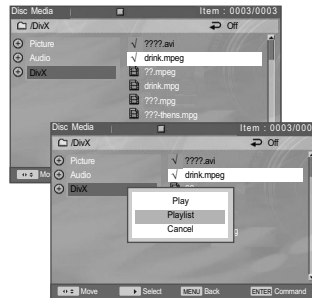

After selecting files as many as you want, press [ENTER] to go to the submenu.

Select 'Playlist' using [▲▼] and press [ENTER].

The Playlist icon will appear in front of the selected files.



- 6 Select 'Play' on the third menu and press [ENTER].
- 7 Press [▶▶] or [◀◀] during playback. The DVD Recorder + VCR will go into Search mode. Press [▶▶] or [◀◀] to select the desired speed: ▶▶X2, ▶▶X4, ▶▶X8, ▶▶X16, ▶▶X32, ▶▶PLAY (forward) or ◀◀X2, ◀◀X4, ◀◀X8, ◀◀X16, ◀◀X32, ◀◀PLAY (backward)
- 8 Use [PLAY/PAUSE] to pause playback while the title is playing.
- 9 To stop playback at any time, press [STOP].

PLAYBACK

- 10 The second menu appears. You can select 'Open', 'Playlist' or 'Cancel'.



Use [▲▼] to select functions.

Open : open the sub-folders.

Playlist : create a playlist with files in the folder.

Cancel : cancel the second menu.

- 11 When the second menu appears while the DivX category is selected, select 'Open' and press [ENTER].

Then you can see 'Playlist' among sub-folders. Select 'Playlist' using [▼] and press [ENTER] to go to the command.

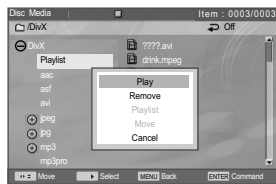

Play : play the file(s) on the playlist.

Remove : delete the file(s) from the playlist.

Cancel : cancel the submenu.

If there is no file on the playlist, add files as it is explained above.

Subtitles

When the subtitles are not displayed provided although it has a file of subtitles:

- 1 Move to the Menu of DivX by pressing the [STOP] button.
- 2 Use [▲▼] to select a file of subtitles you want by using it.
- 3 Select the file of subtitles at that time by pressing the [ENTER] button.
- 4 After moving the file of DivX you want to play, play it by pressing the [ENTER] button.



- Playable DivX files are ".avi", ".divx" and playable DivX subtitles are ".srt", ".smi", ".mbsub", ".svsub", ".ssa", ".txt".
- The file size of the DivX subtitle is limited to 128KB.
- Playable MPEG 4 SP and ASP is XVID, DivX5.1, DivX5.05, DivX5.02, DivX4.1.2, DivX3.11.
- ASP does not support GMC & Qpel (Quarter Pixel).
- Playable biterates is to max. 4MBPS.
- Playable frame number of screens per a second is 30, 25, 24, 12, and 8.
- Playable resolution is from Min. 200X100 to max. 720X640.
- Playable audio stream formats are DTS, MPEG I Layer III, MPEG II, LPCM, WMA and AC-3.
- It may not be played according to a type of DivX files, a recording method, or a disc state. (The device was authenticated for DivX files from the DivX Networks, Inc. and it is available for playing a normal DivX but may be unavailable for playing the DivX files that have been manufactured with an illegal or abnormal Codec.)
- DivX, DivX certified and associated logos are trademarks of DivX Networks, Inc. and are used under license.
- When the image/sound structure of a recorded file have not been undergone the interleave, it will output either the image or the sound.

Audio CD Playback

The DVD Recorder + VCR can play audio CDs on CD-R/RW, DVD+R/RW, DVD-R/RW.

- 1 Insert the disc and close the tray.
- 2 The CD plays automatically. If it doesn't playback, press [PLAY].
- 3 Use [▲▼] to select a track, then press [ENTER] for the second menu. Select 'Play' on the second menu or just press [PLAY].

Playback will stop at the end of the disc.



- 4 You can select 'Play', 'Playlist', and 'Cancel' on the second menu.

For creating a playlist, check tracks by using [▶] then press [ENTER] to activate the second menu. Use [▲▼] to select 'Playlist' and press [ENTER]. The usage of 'Playlist' is same with 'DivX' on the previous page.

- 5 While playing an Audio CD, use [▶▶] or [◀◀] for x2, x4, x8, x16, x32 speed playback.
- 6 Use [PLAY/PAUSE] to pause playback while the disc is playing.
- 7 To stop playback at any time, press [STOP].

PLAYBACK

MP3 Playback (USB Media, DVD)

The DVD Recorder + VCR can play MP3 files on a disc such as CD-R/RW, DVD+R/RW, DVD-R/RW, or on USB Media.

- 1 Prior to playing MP3 files on disc, insert disc and close the tray.

If you want to playback the files in the Removable Storage, connect it to USB In/Out port on the front panel.

- 2 The Media Browser appears automatically. If it doesn't appear, press [MENU] to bring up the Media Browser and select the media (USB Media, DVD) you want to play.

 • Media Browser can be appeared only when you connect a Removable Storage. If not, Disc Media window appears directly.

- 3 Press [ENTER] and select the 'Audio' category using [▲▼], then press [▶].



- 4 Use [▲▼] to select a track or a file, then press [ENTER] and the second menu will appear.

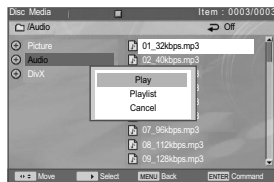

- 5 You can select 'Play', 'Playlist' or 'Cancel'.

Play : play the selected file.

Playlist : add the selected file to playlist.

Cancel : cancel the third menu.

Select 'Play' on the second menu or just press [PLAY].

Playback will stop at the end of the media.

- 6 When the cursor is on the Audio category, press [ENTER]. The second menu appears.



Use [▲▼] to select functions.

Open : open the sub-folders.

Playlist : create a playlist with files in the folder.

Cancel : cancel the second menu.

See 'DivX playback' on page 39~40 to know how to use playlist.

-  • On the MP3 CD menu, you can display the folders on the disc. Use [▲▼] to select the folder icon on the MP3 CD menu then press [ENTER] and select 'OPEN'. You can also display just the tracks in the folders. Use [▲▼] to select a folder then press [▶].
- Press [REPEAT] to repeat a track (file) and press again to repeat the whole media.

Playing a Picture, Audio or DivX files

JPEG Playback (USB Media, DVD)

The DVD Recorder + VCR can play JPEG Picture files on a disc such as CD-R/RW, DVD+R/RW, DVD-R/RW, or on USB Media.

- 1 Prior to playing JPEG files on disc, insert disc and close the tray.

If you want to playback the files in the Removable Storage, connect it to USB In/Out port on the front panel.

- 2 The Media Browser appears automatically. If it doesn't appear, press [MENU] to bring up the Media Browser and select the media (USB Media, DVD) you want to play.

 Media Browser can be appeared only when you connect a Removable Storage. If not, Disc Media window appears directly.

- 3 Press [ENTER] and select the 'Picture' category using [▲▼]. And press [ENTER].

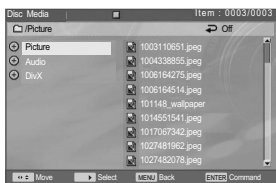

The second menu appears. It is same how to use the second menu in DivX playback.

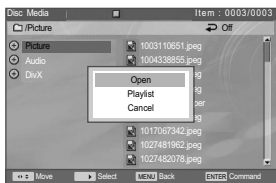

- 4 Select the desired folder using [▲▼] and press [▶].
- 5 Select the thumbnail you want to display using [▲▼] and press [ENTER].

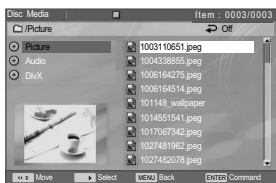

The third menu appears. It is same how to use the second menu in DivX playback.

- 6 Select 'Play' on the third menu and press [ENTER]. The full size image will be displayed and a slide show starts automatically with a time interval of 5 seconds.

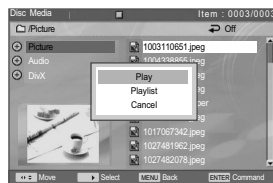

- 7 When a slide show starts, a menu bar will appear at the bottom of the screen.



If you want to remove the menu bar, press [DISPLAY].

[TIMER]: The HELP menu appears.

[▲▼◀▶]: Rotate the image (counter) clockwise.

[NEXT]/[PREV]: Manually skip to the next or previous image.

[ZOOM]: Enter / Exit zoom mode

[0~9]: Jump to the index file

[REC MODE]: Switch refresh mode

[MENU]: Back to the Main Browser

[STOP]: Switch to the DIGEST screen and you can select the image using [▲▼◀▶].

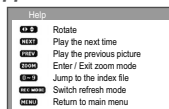

PLAYBACK

[ZOOM]: Enter the zoom mode



[FF]: Zoom In
[REW]: Zoom Out
[ZOOM]: Exit

- 8 Press [STOP] to exit the slideshow.

Playing MP3 Files During a Slide Show

You can enjoy a slide show while listening to MP3 music files.

- 1 Prepare the Disc which includes both MP3 and JPEG files and insert the disc.

If you want to playback the files in the Removable Storage, connect it to USB In/Out port on the front panel.

- 2 The Media Browser appears automatically. If it doesn't appear, press [MENU] to bring up the Media Browser and select the media (USB Media, DVD) you want to play.



- Media Browser can be appeared only when you connect a Removable Storage. If not, Disc Media window appears directly.

- 3 And press [ENTER].
- 4 Use [▲▼] to select 'Audio' category and press [▶].

Select a MP3 file.

Playback it by selecting 'Play' on the third menu or just pressing [PLAY].

- 5 During playback of the MP3 files, press [◀] to return to the selected Media Browser. The music playback will not stop.
- 6 Go to Picture category, and select the image files and press [ENTER].
Select 'Play' on the third menu to start slideshow.
- 7 The MP3 files you selected continue to playback during the JPEG slide show.



- The DVD Recorder + VCR can playback up to 1000 files per disc.
- Customers should note that permission is required in order to download MP3 and music from the Internet. Our company has no right to grant such permission. Permission should always be sought from the copyright owner.

Basic Recording

Recording to TV

Follow the instructions below to record a TV program.

1 Turn on the DVD Recorder+VCR and load a recordable disc or tape.

Make sure your TV input is set to view the DVD Recorder+VCR.

2 Set the desired Recording mode by pressing [REC MODE] repeatedly.

DVD: HQ (High Quality - 1 hr/disc), SP (Standard Play - 2 hrs/disc), EP (Extended Play - 4 hrs/disc), or SEP (Super Long Play - 8 hrs/disc).

VCR: SP (Standard Play), LP (Long Play - 2 times SP)

3 If your DVD Recorder+VCR does not show a TV program, press [INPUT] on the remote control. Use [PR+/-] to select the TV channel you wish to record.

4 Press [AUDIO] to select the audio channel to record (Stereo, BIL, or Mono).

The table below shows what audio channel will be recorded with different settings and different types of broadcasts.

The last column (Monitor Audio) shows what you will hear during recording. For example, if the TV broadcast is in Stereo, then setting the DVD Recorder+VCR to Stereo will record the broadcast in Stereo, and the Monitor Audio will also be in Stereo.

TV Broadcast	Selected Audio	Broadcast Audio		Monitor Audio
		L Ch	R Ch	
MONO	MONO	MONO	MONO	MONO
	STEREO	L	R	STEREO
STEREO	MONO	MONO	MONO	MONO
	BIL I	BIL I	BIL I	BIL I
BIL	BIL II	BIL II	BIL II	BIL II

5 Press [REC (●)] once.

Recording will start. The REC indicator lights on the front panel display.

Recording continues until you press [STOP] or the disc is full.

To record for a fixed length of time, see One Touch Record.

6 Press [STOP (■)] to stop recording.



- The maximum number of DVD titles per disc is 49. If the DVD Recorder+VCR is powered off during DVD recording, the recording will not be saved.
- If a DVD+RW or unfinalized DVD+R disc is inserted in the tray, no title is played automatically after loading is finished.
- If you are recording to a blank DVD+R (+RW) disc, it may take up to 7 minutes (it depends on disc) for post processing after recording.

One Touch Record (OTR)

One Touch Recording allows you to add recording time in fixed increments at the touch of a button.

1 Follow steps 1-4 under Recording from TV.

2 Press [REC (●)] repeatedly to set the length of the recording.

Recording starts after the first press. Each subsequent press increases the recording time by 30 minutes (DVD) within the available space or 30 minutes (VCR, to a maximum of 10 hours).

The recording time is displayed on the front panel display.

PLAYBACK

RECORDING

Checking the Recording Time

Total time and recorded time are displayed on the TV screen after pressing [DISPLAY].

To Pause the Recording

- 1 Press [PLAY/PAUSE] to pause the disc or tape during recording.
- 2 When you want to continue recording, press [PLAY/PAUSE] or [REC] in DVD mode and press [REC] in VCR mode.

Note

- To quit One Touch Recording, press [STOP]. To confirm, select 'OK'. To cancel, select 'Cancel'.
- The DVD Recorder+VCR will automatically power off when One Touch Recording ends.

Tip (VCR mode only)

- Always use [PLAY/PAUSE] for best results when making changes during recording. For example: To change channels during recording, first press [PLAY/PAUSE] to put the unit in Pause mode. Then select the desired channel on the DVD Recorder+VCR, and press [REC] again to resume recording.



- You cannot record on the VCR deck and DVD deck at the same time.
- While the VCR is recording, DVD playback is impossible. And, while the DVD is recording, all VCR functions are disabled.

One Touch Copy - DVD to VHS



If the DVD you are attempting to copy is copy-protected, you will not be able to copy the disc. It is not permitted to copy Macrovision encoded DVDs.

1 Insert a Disc.

Insert the disc you wish to copy in the DVD deck and close the disc tray.

2 Insert a VHS Tape.

Insert a blank VHS videotape into the VCR deck.

3 Find the place on the DVD disc tape from which you want to start recording using the [PLAY/PAUSE], [FF] and [REW] functions. And press [STOP].

4 Press [VCR ◀◀ DVD] on the front panel.

5 Press [ENTER] to select the desired Record Mode in 'Copy to Tape' menu:

- SP (Standard Play)
- LP (Long Play, 2 times SP).

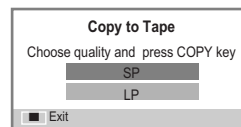

6 Press [VCR ◀◀ DVD] again to start copying.

7 Stop the Copy Process

To stop copying at any time, press [STOP]. You must stop the Copy process manually when the DVD movie ends, or the unit may replay and record over and over again.



If you want to start copy any point of disc

1. Find the place on the DVD (or Disc) from which you want to start recording using the [PLAY/PAUSE], [REW] and [FF] functions.
2. Press [COPY] while DVD is in resume stop (» STOP) mode.
3. Follow the same procedure 5-7.

Copy Edit (DVD →VCR)

During one touch copy you can search or change REC SPEED and resume copy.

- 1 During One Touch Copy, press [PLAY/PAUSE] to enter COPY EDIT mode.

- 2 Search with [FF/REW] or [NEXT/PREV] button.
- 3 Press [VCR ◀◀ DVD] and you can change REC SPEED.
- 4 Press [VCR ◀◀ DVD] again to resume copy.
- 6 Press [VCR ▶▶ DVD] again to start copying.
- 7 **Stop the Copy Process**
To stop copying at any time, press [STOP]. Copying will stop automatically when the VHS tape ends.

One Touch Copy - VHS to DVD

You can copy the contents of a VHS tape to a DVD±R or DVD±RW. This allows you to archive your old VHS tapes to DVD.

 If the VHS videotape you are attempting to copy is copy-protected, you will not be able to copy the tape. It is not permitted to copy Macrovision encoded tapes.

1 Insert a VHS Tape.

Insert the VHS videotape you wish to copy into the VCR deck.

2 Insert a DVD±R or DVD±RW disc.

Insert a blank DVD±R or DVD±RW disc in the DVD deck and close the disc tray.

 When using a DVD+RW disc, you must initialize before copying; see page 30.

3 Find the place on the VHS tape from which you want to start recording using the [PLAY/PAUSE], [FF] and [REW] functions. And press [STOP].

4 Press [VCR ▶▶ DVD] on the front panel.

5 Press [ENTER] to select the desired Record Mode in 'Copy to Disc' menu:

- HQ (High Quality - 1 hr/disc)
- SP (Standard Play - 2 hrs/disc)
- EP (Extended Play - 4 hrs/disc)
- SEP (Very Low Quality - 8 hrs/disc)

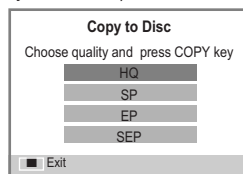

Copy Edit (VCR → DVD)

During one touch copy you can search and resume copy.

- 1 Press [PLAY/PAUSE] to enter COPY EDIT mode.
- 2 Press [PLAY/PAUSE] again to playback.
- 3 Search with [FF/REW] button.
- 4 Press [VCR ▶▶ DVD] to resume copy.

Timer Recording

Timer Recording using Manual Set Record Screen

The Timer Recording function allows you to record up to 16 programs within a period of one month.

- 1 **Insert recordable media such as DVD±R, DVD±RW, recordable VHS tape.**
- 2 **Press [TIMER].**

The 'Timer Recording' menu appears.



- 3 **Select 'Timer Recording' with [▲/▼] and confirm with [ENTER].**

The 'Timer Recording' menu appears.



Use [▲/▼] to move to a timer recording slot, and press [ENTER] to modify it.

If it is the first time to use 'Timer Recording', there is only one timer recording slot.

If you did not set the clock on the DVD Recorder + VCR, you must do so before programming a timer recording.

- **Target** – Choose desired media (DVD or VCR) using [▲/▼].
- **Date** – Choose a date up to 1 month in advance, or select a daily or weekly program.
- **Start** – Set the recording start time.
- **Stop** – Set the recording end time.
- **PR No.** – Choose the desired channel, or one of the external inputs from which to record.
- **Mode** – Choose a Record mode.
[DVD] HQ, SP, EP or SEP
[VCR] SP or LP
- **Repeat** – Choose frequency of the recording.
Once, Daily, Weekly, Weekday, Weekend.



- 4 **Enter the necessary information for your Timer Recording(s).**

- ◀▶ – Moves the cursor left/right.
- ▲▼ – Changes the setting of the current cursor position.
- Press [MENU] to go back to the previous step.
- Press [ENTER] after filling in all the program information.
- Press [TIMER] to exit the Timer Record menu.

- 5 If you modify the saved timer record list, select a slot you want to modify by using [▲/▼].

Press [ENTER] on the selected slot then, the menu will appear.



Edit : to edit each item.

Delete : to delete the selected slot.

Disable/Enable : To be invalid/valid the selected slot.

Cancel : cancel the menu.

- 6 **Press [ENTER] to save the program.**

The Timer Record List will appear.

- 7 **Press [TIMER] to exit the Timer Record List.**

- 8 **Timer indicator will light or start blinking. You must power off the DVD Recorder + VCR to start the Timer Recording.**

Timer Recording using ShowView system

Thanks to this programming system, you no longer need to tediously enter the date, programme number, start and end time. All the information needed by the DVD Recorder + VCR for programming is contained in the ShowView programming number. This ShowView number is found in most TV listings.

- 1 **Insert recordable media such as DVD±R, DVD±RW, recordable VHS tape.**
- 2 **Press [TIMER].**

The 'Timer Recording' menu appears.



- 3 **Select 'ShowView' with [▲/▼] and confirm with [ENTER].**

The 'ShowView' menu appears.



Enter the entire 'ShowView' number. This number is up to 9 digits long and can be found next to the start time of the TV programme in your TV listings magazine.

e.g.: 5-234-89 or 5 234 89

Enter 523489 for the 'ShowView' number.

If you make a mistake, you can clear it with [◀].

You can also select Target, Quality and Repeat by using [◀▶]. To change status of each item, use [▲▼].

- 4 **Press [ENTER] to confirm.**
- 5 The decoded information appears after confirmation. You can go back at any time to change the information by pressing [ENTER] and select 'Edit' on the menu as explained above. Select the appropriate input field using [▲▼]. If required, change the information using [▲▼]. If all the information is correct, press the [ENTER] button. The programming information is stored in a TIMER block.



- 6 **Press [TIMER] to exit the Timer Record List.**
- 7 **Timer indicator will light or start blinking. You must power off the DVD Recorder + VCR to start the Timer Recording.**



ShowView is not available for some countries.

RECORDING

Canceling a Timer Recording

You can clear a Timer Recording any time before the recording actually starts.

- Use [▲▼] to select the program you want to erase on the Timer Recorder List, then press [ENTER] to modify it. Use [▲▼] to select 'Delete' then press [ENTER].

Stopping a Timer Recording in Progress

After a Timer Recording has started, you can still cancel the program by pressing [STOP]. To confirm, select 'OK'. To cancel, select 'Cancel'.



- The Timer indicator lights on the front panel display when the DVD Recorder + VCR is ready for the Timer Recording.
- The timer indicator will flash if any of the following conditions occur:
 - Empty or non-recordable disc is found in the tray when DVD Timer recording starts.
 - When you go into Main Browser, SETUP, Timer Recording menu after Timer Recording setup.
 - When you record the TV signal after Timer Recording setup.
 - When you play titles after Timer Recording setup.
- The DVD Recorder + VCR will automatically power off when the Timer Recording ends.
- There is a short delay when a timer recording finishes to confirm the recorded program. If two timer recordings are set to record sequentially (one right after the other), the very beginning of the later program may not be recorded.

Timer Recording Troubleshooting

Even if a Timer Recording is set, the DVD Recorder + VCR will not record if:

- A protected disc is in the tray; see 'Disc' settings on a page 31.
- There are already 49 titles recorded on the disc.

You cannot enter a Timer Recording if:

- A recording (copying) or playing titles is already under way.
- The start time has already passed.
- 16 Timer Recordings have already been set.

If two or more Timer Recordings overlap:

- Two or more Timer Recordings are overlapped.

If the disc is damaged, the recording may not complete successfully.



Recording Priority

- Timer Recording and OTR (One Touch Record) have the same priority but they have lower priority than manual recording. During manual recording, Timer Recording or OTR will be ignored.

Recording from an External Input

Recording from External Components

You can record from an external component, such as a camcorder, VCR or Digital Camera, connected to any of the DVD Recorder + VCR's external inputs.

- 1 **Make sure the component you want to record from is connected properly to the DVD Recorder + VCR; see pages 15-18.**
- 2 **Use [PR+/-] or [INPUT] to select the external input to record from.**
- 3 **Load a recordable disc or tape.**
When you load a new, blank recordable disc (DVD±RW, DVD±R), the recorder will take a moment to initialize it for recording.
- 4 **Set the desired Recording mode by pressing [REC MODE] repeatedly.**
- 5 **Press [REC (●)] once.**
Recording will start. The REC indicator lights on the front panel display.
Recording continues until you press [STOP] or the disc is full.
To record for a fixed length of time, see 'One Touch Record' on page 45.
- 6 **Press [STOP (■)] to stop recording.**



- If your source is copy-protected, you will not be able to record it using the DVD Recorder + VCR. See 'Copyright Notice' on page 7 for more details.

Recording from a Digital Camcorder

You can record from a digital camcorder connected to the DV IN jack on the front panel of the DVD Recorder+VCR.

You can use the DVD Recorder+VCR remote to control both the camcorder and the DVD Recorder+VCR. Before recording, make sure the digital camcorder is properly connected to the front panel DV IN jack; see page 18.

- 1 **Make sure your digital camcorder is connected to the front panel DV IN jack; see page 18.**
- 2 **Press [INPUT] repeatedly to select the DV input.**
DV appears on the front panel display and the TV screen.

- 3 **Find the place on the camcorder tape from which you want to start recording.**

For best results, pause playback at the point you want to start recording. Depending on your camcorder, you can use the DVD Recorder+VCR remote to control the camcorder using the STOP, PLAY, and PAUSE functions.

- 4 **Press [REC] once to start recording.**

Recording is automatically stopped if the DVD Recorder+VCR detects no signal. You can pause or stop the recording by pressing [PLAY/PAUSE] or [STOP]. You cannot control the camcorder from the remote control during recording.



The source signal must be DVC SD format.

Some camcorders cannot be controlled using the DVD Recorder+VCR remote.

If you connect a second DVD recorder using a DV cable, you cannot control the second recorder from this one.

You cannot control the DVD Recorder+VCR remotely from a component connected to the DV IN jack.

You cannot record date and time information from a DV cassette.

RECORDING

DVD Playback and Editing

This section explains various functions of DVD editing.

Playing a DVD title

Follow these instructions to play back a scene from the Title List.

- 1 Select the title to playback using [**▲▼◀▶**] and press [ENTER].



- 2 Then select 'Play' using [**▲▼**] on the left side menu of the screen. Press [ENTER] to play the title.

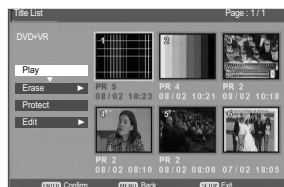

Or press [PLAY/PAUSE] to play the title.

- 3 To stop playback at any time, press [STOP]. Then it will return to the TV screen.

Repeat

While playing the DVD, each press of the [REPEAT] button changes the repeat mode as follows: Title → Chapter → All → Off → Title ...

Erasing a DVD title

Follow these instructions to erase a title from the Title List.

- 1 Select the title to be erased using [**▲▼◀▶**] and press [ENTER].
- 2 Then select 'Erase' using [**▲▼**] on the left side menu.



- 3 Press [ENTER] to erase the title.
- 4 Select 'Erase Title' and a confirming message appears.



Select 'OK' by using [**◀▶**] and press [ENTER].

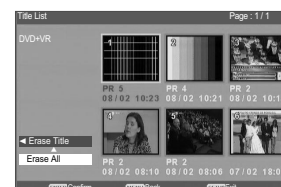
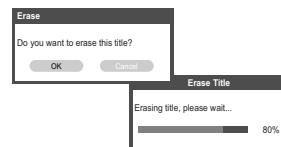

i If you want to erase all titles, select 'Erase All' instead of selecting 'Erase Title'.

Protecting a DVD title

If you want to protect a title from accidental recording, editing, or erasing, you can protect the title. Later, if you change your mind, you can unprotect the title.

- 1 Select the title to be protected using [**▲▼◀▶**] and press [ENTER].
- 2 Then select 'Protect' using [**▲▼**] on the left side menu.



- 3 Press [ENTER] to protect the title.
- 4 Select 'OK' by using [**◀▶**] and press [ENTER].



- 5 Protect icon will appear on the thumbnail of the title.
- 6 To 'Unprotect' the title, select 'Unprotect' in step 5.



Renaming (Labeling) a DVD title

Follow these instructions to rename a title name, i.e., to edit the title of a recorded program.

- 1 Select the title to be labeled using [**▲▼◀▶**] and press [ENTER].
- 2 Then select 'Edit' using [**▲▼**] on the left side menu.



- 3 Press [ENTER] to go to submenu.
- 4 Select 'Rename' using [**▲▼**].



- 5 Press [ENTER] to change the title name.
- 6 The Keyboard Menu will be displayed. Use [**◀▶▲▼**] to select a character or function and press [ENTER].
See pages 31~32.



- 7 After the new title name is complete, select 'Save' and press [ENTER].

Dividing a DVD title

Use to divide the title into two separate titles. Follow these instructions.

- 1 Select the title to be divided using [**▲▼◀▶**] and press [ENTER].
- 2 Then select 'Edit' using [**▲▼**] on the left side menu.
- 3 Press [ENTER] to go to submenu.
- 4 Select 'Divide' using [**▲▼**].



- 5 Press [ENTER] to divide the title in two separate titles.



- 6 Press [PLAY] to start dividing and the cursor will be on the 'Divide'.



- 7 Press [ENTER] when the scene you want to divide into two parts appears.

You can use [PREV/NEXT] or [**◀▶**] to search the scene you want to divide into two parts.

- 8 Press [ENTER] while the cursor is on the 'OK'.



A-B Erase

Follow these instructions to erase a certain part.

- 1 Select the title to be edited using [**▲▼◀▶**] and press [ENTER].
- 2 Then select 'Edit' using [**▲▼**] on the left side menu.
- 3 Press [ENTER] to go to submenu.
- 4 Select 'A-B Erase' using [**▲▼**].



- 5 Press [PLAY] to start playing and the cursor will be on the 'Set Point A'.



- 6 Press [ENTER] when the part you want to erase begins and the cursor will be on the 'Set Point B'.

Set Index Picture

Follow these instructions to set an index picture.

- 1 Select the title to be edited using [▲▼◀▶] and press [ENTER].
- 2 Then select 'Edit' using [▲▼] on the left side menu.
- 3 Press [ENTER] to go to submenu.
- 4 Select 'Set Idx Pic' using [▲▼].



- 7 Press [ENTER] when the part you want to erase ends and the cursor will be on the 'OK'.



- 8 Press [ENTER] to confirm.



- Please note that any edits made will not be in effect until [MENU] or [STOP] button is pressed. During this time, the DVD Recorder + VCR will update the title with the edits made. Once the update is complete, the edits will be available the next time the title edited is played back.
- Press [MENU] or [STOP] to exit from editing menu.



- 5 Press [PLAY] to start playing and the cursor will be on the 'Set Idx Pic'.



- 6 Press [ENTER] when the scene you want to set an index picture appears and the cursor will be on the 'OK'.



- 7 Press [ENTER] to confirm.



Troubleshooting

Check the following guide for the possible cause of a problem before contacting customer support.

Symptom	Cause	Solution
No power.	The power cord is disconnected.	Plug the power cord into the wall outlet securely.
No picture.	The TV is not set to receive DVD Recorder + VCR signal output.	Select the appropriate video input on the TV so the picture from the DVD Recorder + VCR appears on the TV screen.
	The video cable is not connected securely.	Connect the video cable securely.
No sound.	The TV power is turned off.	Turn on the TV.
	The equipment connected with the audio cable is not set to receive DVD Recorder + VCR signal output.	Select the correct input mode on the audio receiver so you can listen to the sound from the DVD Recorder + VCR.
	The audio cables are not connected securely.	Connect the audio cables securely.
	The power on the equipment connected with the audio cable is turned off.	Turn on the equipment connected with the audio cable.
Playback picture is poor.	The audio cables are damaged.	Replace with new ones.
	The disc is dirty.	Clean the disc.
	Tape heads are dirty.	Clean the video heads.
	Tape is a rental or was recorded on another VCR.	Use [Tracking +/-] for manual tracking adjustment while a tape is playing.
DVD Recorder + VCR does not start playback.	No disc is inserted. Nor tape is inserted.	Insert a disc or tape. (Check that the disc indicator on the front panel display is lit.)
	An unplayable disc is inserted.	Insert a playable disc. (Check the disc type, color system, and regional code.)
	The disc is placed upside down.	Place the disc with the playback side down.
	The disc is not placed within the guide.	Place the disc on the disc tray correctly inside the guide.
	The disc is dirty.	Clean the disc.
	The Parental Control level is set.	Cancel the Parental Control function or change the rating level.
Picture from external input is distorted.	The video signal from the external component is copy-protected.	You cannot connect via the DVD Recorder + VCR. Connect the component directly to your TV.
Some channels are skipped over when using [PR+/-].	The skipped channels were deleted with the 'Adjust Channels' feature.	Use the 'Adjust Channels' feature to restore channels.
Picture or sound of broadcasting channel is weak or missing.	Antenna or cables are loose.	Tighten connections or replace cable.
Camcorder image not shown.	Wrong Tuning Band is selected in the DVD Recorder + VCR Setup menu.	Try all 'Auto Set' options; see page 21 for details.
	Camcorder is off.	Turn camcorder on and operate properly.
Camcorder image via A/V input to DVD Recorder + VCR is not shown on TV screen.	The DVD Recorder + VCR's source is not set to AV1, AV2, AVF, or DV.	Use [INPUT] to select AV input channel (AV1, AV2, AVF, or DV).

Symptom	Cause	Solution
Can't play disc recorded on this DVD Recorder + VCR on another DVD player.	The disc was not finalised (or not made compatible if using a DVD+RW).	Finalise the disc; see page 30.
	Some players will not play even a finalised disc.	No solution.
	Discs recorded with copy-once material cannot be played on other players.	No solution.
Cannot record or did not record successfully.	The remaining blank space on the disc is insufficient.	Use another disc.
	The source you are trying to record is copy-protected.	You cannot record the source.
	When setting the recording channel, the channel is tuned on your TV's tuner.	Select the channel on the DVD Recorder + VCR's built-in TV tuner.
Timer Recording not possible.	Clock in DVD Recorder + VCR is not set to correct time.	Set clock to correct time. See 'Set Clock' on page 22.
	Timer has been programmed incorrectly.	Reprogram Timer. See 'Timer Recording' on page 48~50.
	TIMER indicator light does not appear after programming timer.	Reprogram Timer.
Stereo Audio Record and/or Playback not present.	TV is not Stereo-compatible.	No solution.
	Broadcast program is not in stereo format.	No solution.
	DVD Recorder + VCR A/V Out jacks are not connected to TV A/V In jacks.	Make A/V connections. Stereo is available only via A/V output from DVD Recorder + VCR.
	DVD Recorder + VCR Audio/Video Out is not selected for viewing at the TV. DVD Recorder + VCR's TV audio channel is set to BIL or MONO.	Select AUX or A/V source as TV input. Set TV audio channel mode to Stereo. See 'Changing the TV Audio Channel' on page 34.
Remote control does not work properly.	The remote control is not pointed at the remote sensor of the DVD Recorder + VCR.	Point the remote control at the remote sensor of the DVD Recorder + VCR.
	The remote control is too far from the DVD Recorder + VCR.	Operate the remote control within 23 ft (7m).
	There is an obstacle in the path of the remote control and the DVD Recorder + VCR.	Remove the obstacle.
	The batteries in the remote control are dead.	Replace the batteries.



RESET : If the set is in malfunctions, unplug the power cord, and then plug it in after 5 seconds. As this set is a Digital Multimedia Product, malfunction may occur.

Moisture Condensation

Moisture condensation can occur:

When the DVD Recorder + VCR is moved from a cold place to a warm place.

Under extremely humid conditions.

In locations where moisture condensation may occur:

Keep the DVD Recorder + VCR plugged into an AC power outlet with the power on. This will help prevent condensation.

When condensation has occurred, wait a few hours for the DVD Recorder + VCR to dry before using it.

Technical Specifications

General

Power requirements	200–240V~, 50/60 Hz
Power consumption	Operation : Maximum 26W Standby : 5W
Dimensions(approx.)	430 *92 *312 (w*h*d)
Mass (approx.)	4.96 Kg
Operating temperature	5°C to 35°C
Operating humidity	5% to 90%
Signal system	PAL Colour

Recording

Recording formats	DVD Video Recording, DVD-VIDEO
Recordable discs	DVD±R, DVD±RW
Recordable time	[DVD] (Approx.) 1 hour (HQ mode), 2 hours (SP mode), 4 hours (EP mode), 8 hours (SEP mode) [VCR] SP: 3 Hours (E-180), LP : 6 Hours (E-180)

Video recording format

Sampling frequency	27MHz
Compression format	MPEG 2

Audio recording format

Sampling frequency	48kHz
Compression format	MPEG1 Layer2

VCR Specifications

Head system	4 Head Video, 2 Head Hi-Fi helical scan azimuth system
Timer	24-hour display type
Tape speed	SP: 23.39 mm/sec LP: 11.70 mm/sec
Tape width	12.7 mm
Rewind time	less than 150 sec (E-180)
Channel coverage	VHF:2-12,13-20,74-80 / UHF:21-69 / CATV:1-41
Frequency range	20Hz to 20kHz
Signal-to-noise ratio	43 dB
Dynamic range	75 dB
Channel separation	45 dB

DVD Specifications

Laser system	Semiconductor laser, wavelength 650 nm
Frequency response	DVD (PCM 48 kHz): 8 Hz to 22 kHz, CD: 8 Hz to 20 kHz
Video S/N	More than 60 dB
Audio S/N	More than 90 dB
Harmonic distortion	Less than 0.06%

Dynamic range	More than 90 dB
Resolution	Over 500 lines (HQ Recording)

Inputs

Antenna In	Antenna or CATV input, 75 Ω
Video In	1.0 Vp-p 75 Ω, sync negative, RCA jack x 2
Audio In	-8.8 dBm more than 47 k, RCA jack (L, R) x 2
DV IN	4pin (i.LINK/IEEE 1394 standard)
USB In/Out	Series 'A' Connector (USB 2.0 Full Speed)

Outputs

Video Out	Composite output (1.0 Vp-p, unbalanced) RGB output (75 in load, R:0.7Vp-p, G:0.7Vp-p, B:0.7Vp-p)
Component Video Out	(Progressive Scan) (Y) 1.0 V (p-p), 75 Ω, negative sync, RCA jack x 1 (Pb)/(Pr) 0.7 V (p-p), 75 Ω, RCA jack x 2
Audio Out	Digital audio : 0.5 V (p-p), 75 Ω, RCA jack x 1 Analog audio : 1.1 Vrms (1kHz, -6 dB), 600 Ω, RCA jack (L, R) x 2
HDMI video/audio output	19 pin (HDMI standard, Type A)

Accessories

RF cable	1
Remote control	1
Batteries	2

Design and specifications are subject to change without notice.

Manufactured under license from Dolby Laboratories. 'Dolby' and the double-D symbol are trademarks of Dolby Laboratories. DTS and DTS Digital Out are registered trademarks of Digital Theater Systems, Inc.

REFERENCE

Free Manuals Download Website

<http://myh66.com>

<http://usermanuals.us>

<http://www.somanuals.com>

<http://www.4manuals.cc>

<http://www.manual-lib.com>

<http://www.404manual.com>

<http://www.luxmanual.com>

<http://aubethermostatmanual.com>

Golf course search by state

<http://golfingnear.com>

Email search by domain

<http://emailbydomain.com>

Auto manuals search

<http://auto.somanuals.com>

TV manuals search

<http://tv.somanuals.com>