

DVB-T VCR/DVD RECORDER

Instruction Manual

DRVT-40
DRVT-43



HELPLINE NUMBER
0870 100 2525

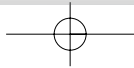

Safety Instructions

Please keep the product's guarantee sheet and receipt in a safe place.

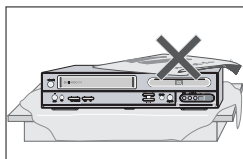
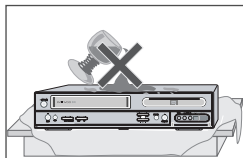
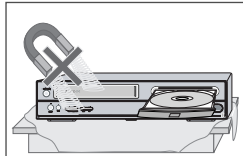
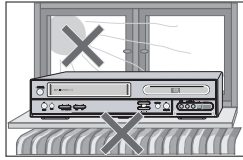

Precautions



- Read this booklet carefully.
- Make sure the rating of your household electricity supply matches that shown on the back of your product.
- Read this page and chapter 'Setting up your product' to help you set up and adjust your product correctly.
- Do not put the product in a hot or humid place.
- Do not open the product. Get a qualified technician to carry out any repairs.
- Do not connect the product to the power supply if you have just moved it from a cold environment to a warm room. This can lead to condensation inside the product, which can damage it. Wait for approx. 2 hrs for it to reach room temperature.
- Make sure the product is placed at least 10 cm apart from other home appliances or obstacles to ensure sufficient ventilation.
- The product should not be exposed to dripping or splashing and no objects filled with liquids, such as vases should be placed on top of the product.
- Before a storm and/or lightning, unplug the product from the mains supply and aerial.
- Put the product on a steady flat surface.
- Only clean the product with a soft, lint-free cloth. Do not use harsh or alcohol-based cleaning agents.

For your own Safety



- There are no components in this product you can service or repair yourself.
- Do not open the case of the product. Only allow a qualified engineer to repair or service your product.
- This product is designed to work continuously. Switching it off (stand-by mode) does not disconnect it from the mains. To disconnect it from the mains you have to unplug it.

Important Safeguards

	CAUTION RISK OF ELECTRIC SHOCK DO NOT OPEN	
<p>CAUTION: TO REDUCE THE RISK OF ELECTRIC SHOCK, DO NOT REMOVE COVER (OR BACK). NO USER-SERVICEABLE PARTS INSIDE. REFER SERVICING TO QUALIFIED SERVICE PERSONNEL.</p>		

The lightning flash with arrowhead symbol, within an equilateral triangle, is intended to alert the user to the presence of uninsulated 'dangerous voltage' within the product's enclosure that may be of sufficient magnitude to constitute a risk of electric shock.



The exclamation point within an equilateral triangle is intended to alert the user to the presence of important operating and servicing instructions in the literature accompanying the appliance.



WARNING TO REDUCE THE RISK OF FIRE OR ELECTRIC SHOCK, DO NOT EXPOSE THIS APPLIANCE TO RAIN OR MOISTURE.

CAUTION TO PREVENT ELECTRIC SHOCK, MATCH WIDE BLADE OF PLUG TO WIDE SLOT, FULLY INSERT.

CAUTION Any changes or modification in construction of this device which are not expressly approved by the party responsible for compliance could void the user's authority to operate the equipment.

- **Make sure the unit should be placed at least 10 cm apart from the other home appliances or the obstacles to get sufficient ventilation.**
- **This unit shall not be exposed to dripping or splashing and no objects filled with liquids, such as vases, shall be placed on this unit.**
- **Switching it off does not disconnect it from the mains (stand-by). To disconnect it from the mains, you have to unplug it.**

■ 2 ■

IMPORTANT FOR LASER PRODUCTS

LASER This Digital Video Disc Recorder employs a Laser System. To ensure proper use of this product please read this owner's manual carefully and retain for future reference. Should the unit require maintenance, contact an authorised service location - see service procedure.

Use of control adjustments or the performance of procedures other than those specified may result in hazardous radiation exposure.

To prevent direct exposure to the laser beam, do not try to open the enclosure. Visible laser radiation when open and interlocks defeated.

DO NOT STARE INTO THE BEAM.

DANGER Visible laser radiation when open and interlock failed or defeated. Avoid direct exposure to beam.

CLASS 1
LASER PRODUCT

CAUTION Do not open the top cover. There are no user serviceable parts inside the Unit; leave all servicing to qualified service personnel.

✓ RoHS (Directive 2002/95/EC) Compliant



This environment-friendly product does not contain the EU RoHS restricted substances (Pb, Hg, Cd, Cr6+, PBB, and PBDE).

This set has been designed and manufactured to assure personal safety. Improper use can result in electric shock or fire hazard. The safeguards incorporated in this unit will protect you if you observe the following procedures for installation, use and servicing. This unit is fully transistorised and does not contain any parts that can be repaired by the user.

1 READ INSTRUCTIONS

All the safety and operating instructions should be read before the unit is operated.

2 RETAIN INSTRUCTIONS

The safety and operating instructions should be retained for future reference.

3 HEED WARNINGS

All warnings on the unit and in the operating instructions should be adhered to.

4 FOLLOW INSTRUCTIONS

All operating and use instructions should be followed.

5 CLEANING

Unplug this unit from the wall outlet before cleaning. Do not use liquid cleaners or aerosol cleaners. Use a damp cloth for cleaning.

6 ATTACHMENTS

Do not use attachments unless recommended by the unit's manufacturer as they may cause hazards.

7 WATER AND MOISTURE

Do not use this unit near water- for example, near a bath tub, wash bowl, kitchen sink or laundry tub, in a wet basement, or near a swimming pool.

8 ACCESSORIES

Do not place this unit on an unstable, stand, tripod, bracket, or table. The unit may fall, causing serious injury to a child or adult as well as serious damage to the unit. Use this unit only with a cart, stand, tripod, bracket, or table recommended by the manufacturer.

9 VENTILATION

Slots and openings in the case are provided for ventilation to ensure reliable operation of the unit and to protect it from overheating. These openings must not be blocked or covered. These openings must not be blocked by placing the unit on a bed, sofa, rug, or other similar surface. This unit should never be placed near or over a radiator or heat radiator. This unit should not be

placed in a built-in installation such as a bookcase or rack unless proper ventilation is provided or the manufacturer's instructions have been adhered to.

10 POWER SOURCES

This unit should be operated only from the type of power source indicated on the marking label. If you are not sure of the type of power supply to your home, consult your dealer or local power company. For units intended to operate from battery power, or other sources, refer to the operating instructions.

11 POWER-CORD PROTECTION

Power-supply cords should be routed so that they are not likely to be walked on or pinched by items placed upon or against them, paying particular attention to cords at plugs, mains sockets, and the point where they exit from the unit. The mains plug is used as the disconnect device, the disconnect device shall remain readily operable.

12 LIGHTNING

For added protection for this unit during a lightning storm, or when it is left unattended and unused for long periods of time, unplug it from the wall outlet and disconnect the antenna or cable system. This will prevent damage to the unit due to lightning and power line surges.

13 DISC TRAY

Keep your fingers well clear of the disc as it is closing. It may cause serious personal injury.

14 OVERLOADING

Do not overload wall outlets of extension cords as this can result in a risk of fire or electric shock.

15 OBJECT AND LIQUID ENTRY

Never push objects of any kind into this unit through openings as they may touch dangerous voltage points or 'short-out' parts that could result in a fire or electric shock. Never spill liquid of any kind on the unit.

16 BURDEN

Do not place a heavy object on or step on the product. The object may fall, causing serious personal injury and serious damage to the product.

17 DISC

Do not use a cracked, deformed or repaired disc. These discs are easily broken and may cause serious personal injury and product malfunction.

18 SERVICING

Do not attempt to service this unit yourself as opening or removing covers may expose you to dangerous voltage or other hazards. Refer all servicing to qualified service personnel.

19 DAMAGE REQUIRING SERVICE

Unplug this unit from the wall outlet and refer servicing to qualified service personnel under the following conditions.

- A. When the power-supply cord or plug is damaged.
- B. If liquid has been spilled, or objects have fallen into the unit.
- C. If the unit has been exposed to rain or water.
- D. If the unit does not operate normally by following the operating instructions. Adjust only those controls that are covered by the operating instructions. Improper adjustment of other controls may result in damage and will often require extensive work by a qualified technician to restore the unit to its normal operation.
- E. If the unit has been dropped or the cabinet has been damaged.
- F. When the unit exhibits a distinct change in performance-this indicates a need for service.

20 REPLACEMENT PARTS

When replacement parts are required, have the service technician verify that the replacements he uses have the same safety characteristics as the original parts. Use of replacements specified by the unit manufacturer can prevent fire, electric shock, or other hazards.

21 SAFETY CHECK

Upon completion of any service or repairs to this unit, ask the service technician to perform safety checks recommended by the manufacturer to determine that the unit is in safe operating condition.

22 WALL OR CEILING MOUNTING

The product should be mounted to a wall or ceiling only as recommended by the manufacturer.

23 HEAT

The product should be situated away from heat sources such as radiators, heat registers,

stoves, or other products (including amplifiers) that produce heat.

24 SAFE BATTERY USAGE

To prevent battery electrolyte leakage, which may result in injury and damage to the unit or other objects, observe the following precautions;

- A. All batteries must be installed with the proper polarity.
- B. Do not mix new with old or used batteries.
- C. Only use batteries of the same type and brand.
- D. Remove the batteries when they are not to be used for a long period time.
- E. When the batteries have become discharged, they must be disposed of in a safe manner which complies with all applicable laws.

25 WEEE (Waste of electrical and electronic equipment)

The meaning of the symbol on the product, its accessory or packaging indicates that this product shall not be treated as household waste. Please, dispose of this equipment at your applicable collection point for the recycling of electrical & electronic equipments waste. In the European Union and Other European countries there are separate collection systems for used electrical and electronic product. By ensuring the correct disposal of this product, you will help prevent potential hazards to the environment and to human health, which could otherwise be caused by unsuitable waste handling of this product. The recycling of materials will help conserve natural resources. Please do not therefore dispose of your old electrical and electronic equipment with your household waste. For more detailed information about recycling of this product, please contact your local city office, your household waste disposal service or the shop where you purchased the product.



Table of Contents

Introduction

Safety Instructions	1
Important Safeguards	2
Table of Contents	5
Introduction	6
Overview Features	7
Identification of Controls	12

Connections

Connecting Antenna/Cable	17
Connecting a TV	17
Connecting an Amplifier/Receiver	19
Connecting Optional Equipment	19
Connecting to USB	20
Connecting a Digital Camcorder	20

Setup

Initial Installation	21
Guide to Digital Service	22
Information Service	24
Setup menu	25
Setup Menu Overview	25
Menu Navigation	25
INSTALLATION Settings	25
RECORD/PLAY OPTIONS Settings	28
LANGUAGES Settings	29
Preferences Settings	30
Parental Settings	32
System Information	35
Update/ Restore	36

On-Screen Display Overview	37
-----------------------------------	-----------

Playback

DVD Playback	39
Playing a Picture or Music files	41
DivX Playback (DVD, USB)	41
Audio CD Playback	42
MP3 Playback	42
JPEG Playback	42
Playing MP3 files during a slide show	43
VCR Playback	44

Recording

Basic Recording	46
Recording to TV	46
One Touch Record (OTR)	46
Checking the Recording Time	47
To Pause the Recording	47
One Touch Copy - DVD to VHS	47
One Touch Copy - VHS to DVD	48
Timer Recording	49
Timer Recording using Manual Record Screen	49
Canceling a Timer Recording	50
Stopping a Timer Recording in Progress	50
Timer Recording using the EPG application	50
Canceling a Timer Recording (EPG)	51
Stopping a Timer Recording in Progress	51
Timer Recording Troubleshooting	51
Recording from an External Input	52

Editing

Disc Playback and Editing	53
Disc Media Operation	56

Reference

Troubleshooting	59
Technical Specifications	61
Warranty Card	63

Introduction

Thank you for purchasing the DVB-T VCR/DVD recorder.

Equipped with the latest technology and design, the DRVT-40/DRVT-43 is a set-top box ideal for digital terrestrial broadcast reception and a VCR/DVD Recorder.

The simple installation and operation, user-friendly tree structured OSD, Digital audio output that's Dolby Digital ready, and advanced video clarity made for TV that's designed to enrich the viewer experience.

Outstanding stability and comfort are its built-in features.

In addition to delivering more channels with its new highly sensitive tuner, DRVT-40/DRVT-43 boasts the Electronic Program Guide (EPG), for even better program information on all channels, and information that enables access to subtitles and teletext for a bounty of useful information on programs and broadcast signals. As a DVB-T VCR/DVD recorder, our product supports 'dual media' recording allowing DVD+RW format recording (+VR) on either DVD-R, DVD-RW, DVD+R or DVD+RW media.

This system gives flexibility for the consumer to use any of the above media formats for recording in the same system.

With the latest software, viewers are always sure to enjoy endless hours of extraordinary digital broadcasts and an abundance of data.

Overview Features

Overview

MPEG-2 Digital & Fully DVB-T Compliant

Interactivity & Digital Teletext (MHEG 5)

- Allows a split screen combination of your programme plus live text news & sport information.

User-friendly EPG (8 days capability)

- Extended information shows the full program information
- Channel Search with Category or Keyword

Parental control with block on system, all channels and programs by age limitation

Multiple Connectivity to Hi-Fi or Home Theatre

Channel list mode in both all and favourite groups

Channel sorting by Channel Number

Video format in 4:3 or 16:9

Supports audio language selection in SETUP

Program Recording

: Recording from TV tuner or AV input

- Automatically sets up timer recording using EPG
- Manually sets up timer recording for a TV program or a recurring TV program
- Timer setting supports automatic Turn-On and Off daily or weekly

Personal video copying by external input

- DV camcorder tapes
- VCR tapes

Simple, easy video editing

- Rename programs, Delete programs, Split programs, Segment programs
- Identify and keep the desired video and remove the parts you do not need.

DVD Playback

DVD, VCD, SVCD, MPEG file video, MPEG-1 Layer 2, MP3, CD stereo audio, Dolby Digital & DTS digital audio output.

Which discs you can use

The following discs can be used in your DVB-T VCR/DVD Recorder:

Playback and recording

DVD+RW (Digital Versatile Disc + ReWritable)

DVD+R (Digital Versatile Disc + Write-Once)

DVD-R (DVD-Recordable) / DVD-RW (DVD-Rewritable): Recording with +VR Format (Dual media support).

These discs can only be played back in other DVD players or recorders if the recording was made in 'Video mode' and the recording was finalised.

Playback only

DVD Video (Digital Versatile Disc)

Audio CD (Compact Disc Digital Audio)

CD-R (CD recordable) Audio and MP3 files

CD-RW (CD rewritable) Audio and MP3 files

VCD, SVCD



Not all recordable CDs may be played by your player.

Regional code

If the region number on your DVD disc does not correspond to the region number of this player, the disc cannot be played.



Dual Media

Supporting Disc	±RW / ±R
Recording Format	±Disc + VR format
Finalise required for	-RW, -R, +R
Compatibility with other Players	All discs compatible after finalising
Consumer	Does not need selection (recording format)

Remark :

DRVT-40/ DRVT-43 DVB-T VCR/DVD Recorder supports 'dual media' recording allowing DVD+RW format recording (+VR) on either DVD-R, DVD-RW, DVD+R or DVD+RW media. Any editing feature that is available with the +RW logical format is available on any of the media types. This system allows the flexibility for the consumer to use any of the above media formats for recording in the same system. Since the +VR format is DVD-Video compatible, the consumer can take any disc recorded on this platform and should be capable of playing it back on the majority of DVD players on the market.

Disc-related Terms

Title (DVD only)

The main film, accompanying feature content, or music album. Each title is assigned a title reference number enabling you to locate it easily.

Chapter (DVD only)

Sections of a movie or a musical piece that are smaller than titles. A title is composed of one or several chapters. Each chapter is assigned a number to enable you to easily locate the chapter you want. Depending on the disc, chapters may not be labeled.

Track (Audio CD only)

Sections of a musical piece on an audio CD. Each track is assigned a number, enabling you to easily locate the track you want.

DVD, DVD+R, DVD+RW?

What is a DVD?

DVD (Digital Versatile Disc) is a storage medium that combines the convenience of the compact disc with the latest digital video technology. DVD video uses modern MPEG2 data compression technology that enables an entire feature film to be stored on a single five inch disc.

How good is the resolution of DVD compared with VHS?

The razor-sharp digital images have more than 500 lines of resolution at 720 pixels per line. This is more than twice as high as VHS and even better than laser disc quality. DVD picture quality is easily comparable to the digital masters produced in recording studios.

What is a DVD+RW?

DVD+ReWritable uses 'phase change' media, the same technology on which rewritable CDs are based. A high-performance laser is used to change the reflective properties of the recording layer; this process can be repeated more than a thousand times.

What is a DVD+R?

Unlike a DVD+RW disc, a DVD+R (write-once DVD) can only be written to once. If it is not finalised after a recording, further recordings can be added to it. Old recordings can be deleted but they can no longer be overwritten. The deleted recordings (titles) are marked 'deleted title'.

Before a DVD+R can be played in a DVD player, it must be finalised in the DVB-T VCR/DVD Recorder. Once this process is complete, no further recordings can be added.

What can I do with my DVB-T VCR/DVD Recorder?

Your DVB-T VCR/DVD Recorder is a machine for recording and playing back digital video discs with 'two-way' compatibility with the universal DVD video standard. This means:

- existing DVD video discs can be played on the recorder.
- recordings made on your DVB-T VCR/DVD Recorder can be played on other DVD video players and DVD-ROM drives.

satellite broadcasts. If copy-protected material is encountered during a recording, recording will pause or stop automatically and an error message will be displayed on-screen.

About DVD Recording

Notes on Recording

- The recording times shown are not exact because the DVB-T VCR/DVD Recorder uses variable bit-rate video compression. This means that the exact recording time will depend on the material being recorded.
- When recording a TV broadcast, if the reception is poor or the picture contains interference, the recording times may be shorter.
- Discs recorded at high speeds (equal to or greater than 2X) may not be recognized.
- If you record still pictures or audio only, the recording time may be longer.
- The displayed times for recording and time remaining may not always add up to the exact length of the disc.
- The available recording time may decrease if you heavily edit a disc.
- When using a DVD+R disc, you can keep recording until the disc is full, or until you finalise the disc. Before you start a recording session, check the amount of recording time left on the disc.

Recording TV Audio Channels

The DVB-T VCR/DVD Recorder can record channel audio. For analogue TV broadcasts, this usually means mono or stereo, but digital TV programs are broadcasted in multi-lingual audio channel. You can record multiple channel audio.

Restrictions on Video Recording

- You cannot record copy-protected video using this DVB-T VCR/DVD Recorder. Copy-protected video includes DVD-Video discs and some

Copyright Notice

- Audio and video recordings you make using the DVB-T VCR/DVD Recorder are for your personal use only. You may not sell, lend, or rent them to other people.
- This product incorporates copyright protection technology that is protected by method claims of certain U.S. patents and other intellectual property rights owned by Macrovision Corporation and other rights owners. Use of this copyright protection technology must be authorized by Macrovision Corporation, and is intended for home and other limited viewing uses only unless otherwise authorized by Macrovision corporation. Reverse engineering or disassembly is prohibited.

Precautions

Handling the Unit

When shipping the unit

The original shipping carton and packing materials will come in handy. For maximum protection, re-pack the unit as it was originally packaged at the factory.

When setting up the unit

The picture and sound of a nearby TV, VCR, or radio may be distorted during playback. In this case, position the unit away from the TV, VCR, or radio, or turn off the unit after removing the disc.

To keep the surface clean

Do not use volatile liquids, such as insecticide spray, near the unit. Do not leave rubber or plastic products in contact with the unit for a long period of time. They will leave marks on the surface.

Cleaning the Unit

To clean the cabinet

Use a soft, dry cloth. If the surfaces are extremely dirty, use a soft cloth lightly moistened with a mild detergent solution. Do not use strong solvents such as alcohol, benzene, or thinners, as these might damage the surface of the unit.

To obtain a clear picture

The DVB-T VCR/DVD Recorder is a high-tech, precision device. If the optical pick-up lens and disc drive parts are dirty or worn, the picture quality will be poor. Regular inspection and maintenance are recommended after every 1,000 hours of use. (This depends on the operating environment.) For details, please contact your nearest dealer.

Remote Control Operation Range

Point the remote control at the remote sensor and press the buttons.

Distance: Within 23 ft (7 m) of the remote sensor.

Angle: Within 30° in each direction of the remote sensor.

Remote Control Battery Installation

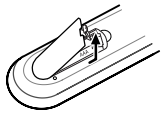

Detach the battery cover on the rear of the remote control, and insert two AAA batteries. Make sure the polarities (+ and -) are aligned correctly.



Caution

Do not mix old and new batteries. Never mix different types of batteries (standard, alkaline, etc.).

Notes on Discs

Handling Discs

Do not touch the playback side of the disc. Hold the disc by the edges so that fingerprints will not get on the surface. Do not stick paper or tape on the disc.



Storing Discs

After playing, store the disc in its case.

Do not expose the disc to direct sunlight or sources of heat, or leave it in a parked car exposed to direct sunlight, as there may be a considerable temperature increase inside the car, which could distort the disc.

Cleaning Discs

Fingerprints and dust on the disc can cause poor picture quality and sound distortion. Before playing, clean the disc with a clean cloth. Wipe the disc from the centre outward.

Do not use strong solvents such as alcohol, benzene, thinners, commercially available cleaners, or anti-static spray intended for older vinyl records.

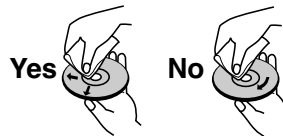

What is DV?

Using DV, also known as i.LINK, you can connect a DV-equipped camcorder to the DVB-T VCR/DVD Recorder using a single DV cable for input and output of audio, video, data and control signals. The i.LINK interface is also known as IEEE 1394-1995.

'i.LINK' and the 'i.LINK' logo are trademarks.

- The DVB-T VCR/DVD Recorder is only compatible with DV-format (DVC-SD) camcorders. Digital satellite tuners and Digital VHS video recorders are not compatible.
- You cannot connect more than one DV camcorder at a time to the DVB-T VCR/DVD Recorder.
- It may not always be possible to control the connected camcorder via the DV IN jack.
- Audio input to the DV IN jack should be 32 or 48kHz (not 44.1kHz).
- Picture disturbance on the recording may occur if the source component pauses playback or plays an unrecorded section of tape, or if the power fails in the source component, or if the DV cable becomes disconnected.

About HDMI

HDMI (High Definition Multimedia Interface) supports both video and audio on a single digital connection for use with DVD Players, Set-Top Boxes, and other AV devices. HDMI was developed to provide the technologies of HDCP (High Definition Contents Protection). HDCP is used to protect digital content transmitted and received. HDMI has the capability to support standard, enhanced, or high-definition video plus standard to multi-channel surround-sound audio, HDMI features include uncompressed digital video, a bandwidth of up to 5 gigabytes per second, one connector (instead of several cables and connectors), and communication between the AV source and AV devices such as DTVs.

HDMI, the HDMI logo and High-Definition Multimedia Interface are trademarks or registered trademarks of HDMI licensing LLC.

Additional Information for HDMI

When you connect a HDMI or DVI compatible device make sure of the followings:

- Try switching off the HDMI/DVI device and this recorder. Next, switch on the HDMI/DVI device and leave it for around 30 seconds, then switch on this recorder.
 - The connected device's video input is set correctly for this unit.
 - The connected device is compatible with 720x576i or 720x576p, 1280x720p or 1920x1080i (i:Interlaced scan mode, p:Progressive scan mode) video input.
- Not all HDCP-compatible DVI devices will work with this recorder.
- It's impossible to copy protected-DVD title's playback in non-HDCP devices.

What is USB (Universal Serial Bus)?

USB is an external bus standard that supports data transfer rates of 12 Mbps. A single USB port can be used to connect up to 127 peripheral devices, such as digital cameras, MP3 players, and removable storage. USB also supports Plug-and-Play installation and hot plugging.

- The USB port provides USB 2.0 Full Speed connectivity and also backward compatibility with USB 1.1 (USB 1.0) devices.



- If you happen to use a bad quality USB cable, the USB device might not be recognized.
- The compatibility with MP3 players and digital still cameras is somewhat restricted.
 - This DVD Recorder + VCR can playback only mp3 format contents.
 - This DVD Recorder + VCR does not support the audio contents encrypted by DRM (Digital Right Management).
- Either USB hub device or hub extension connectivity is not supported.
- There are lots of kinds of USB devices. Some of the USB devices mentioned above might not be compatible with this DVD Recorder + VCR. In other words, the USB host function of this product does not guarantee the compatibility with all of USB devices.
- This DVD Recorder + VCR supports both the high and full speed USB devices (Does not support Low speed devices).

Identification of Controls

Front Panel

DRV-40

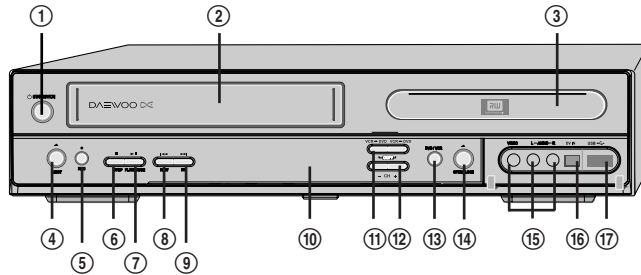

DRV-43

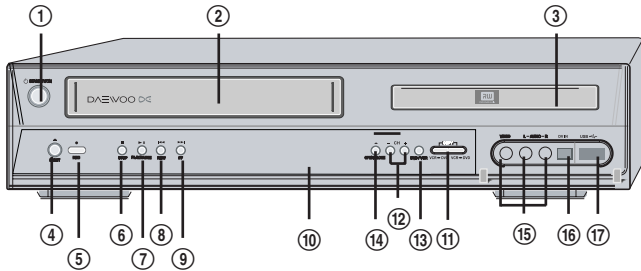

- | | |
|---|--|
| <p>① STANDBY/ON
Turns the DVB-T VCR/DVD Recorder on and off.</p> <p>② Cassette Compartment (VCR deck)
Insert a video cassette here.</p> <p>③ Disc Tray (DVD deck)
Insert a disc here.</p> <p>④ VCR EJECT
Ejects the tape in the VCR deck.</p> <p>⑤ REC
Starts recording. Press repeatedly to set the recording time.</p> <p>⑥ STOP
Stops playback or recording.</p> <p>⑦ PLAY/PAUSE
Starts playback of a disc or tape. Pauses playback or recording temporarily.</p> <p>⑧ REW
DVD: Skips to previous chapter.
VCR: Rewinds the tape during Stop mode. Press during Play mode for fast reverse picture search.</p> <p>⑨ FF
DVD: Skips to next chapter.
VCR: Advances the tape during Stop mode. Press during Play mode for fast forward picture search.</p> | <p>⑩ Front Panel Display
Shows the current status of the DVB-T VCR/DVD Recorder.</p> <p>⑪ COPY
Copies from DVD to VCR (or from VCR to DVD).</p> <p>⑫ CH+/-
Scans up or down through memorized channels. Also moves up and down in menus.</p> <p>⑬ SELECT DVD/VCR
Toggles control between the DVD mode and the VCR mode.</p> <p>⑭ OPEN/CLOSE (DVD)
Opens or closes the disc tray.</p> <p>⑮ AVF Input (VIDEO, L-AUDIO-R)
Connects to the audio/video output of an external source (VCR, Camcorder, etc.).</p> <p>⑯ DV Input
Connects to the DV output of an external source (VCR, Camcorder, etc.).</p> <p>⑰ USB Input
Connects to the USB device with Flash memory.</p> |
|---|--|

Front Panel Display



Channel

001 TV Channel

Input mode

AV-1 AV1 input

AV-2 AV2 input

F-AV Front - AV input

DV DV input

Copy

VCR COPY DVD VCR to VCR copying

DVD COPY VCR VCR to DVD copying

Recording on disc

11:15 DVD Indicates a DVD Timer recording is set.

11:15 DVD Indicates a DVD Timer Recording is in standby mode.

REC DVD Indicates the DVD is recording.

0:30 DVD OTR Recording mode

RECP DVD Recording Pause mode

Recording on tape

VCR 11:15 Indicates a VCR Timer Recording is set.

11:15 Indicates a VCR Timer Recording is in standby mode.

VCR REC Indicates the VCR is recording.

VCR 0:30 OTR Recording mode

VCR RECP Recording Pause mode





















Others

VCR Indicates the DVB-T VCR/DVD Recorder is in VCR mode (set by [TV/VCR] button).













TV Indicates the DVB-T VCR/DVD Recorder is in TV mode (set by [TV/VCR] button).

Remote Control



-  Turns the DVB-T VCR/DVD Recorder on and off.
-  - Opens and closes the disc tray in DVD mode.
- Ejects the tape in the VCR deck in VCR mode.
-  Selects VCR mode.
-  Selects DVD mode.
-  Switches between the DVB-T VCR/DVD Recorder tuner or your TV tuner.
-  - Selects numbered options in menus.
- Selects TV channels.
- Manually adjusts tracking.
-  Displays information on the disc when you press this button once.
Displays DVD navigator when you press this button twice.
-  Displays a full list of searched channels or favourite list.
-  Accesses DVD disc menus.
-  Displays or exits the Setup menu.
-  Shows TV Guide (EPG : Electronic Programme Guide)
-  Returns to previous menu (mode)
-  - ◀▶▲▼ : Selects menu options.
- CH +/- : Selects channels.
- VOL +/- : Adjusts volume.
-  Confirms menu selections.
Displays information on the current and next programmes on the channel
-  RED/GREEN/YELLOW/BLUE (Colour Buttons)
: used for selecting interactive applications (Additional Option Selection)
-  - Starts playback.
- Pauses playback or recording temporarily. Press again to exit Pause mode.
-  - DVD: Searches backward/forward.
- VCR: Rewinds/advances during Stop mode. Press during Play mode for fast reverse/forward picture search.
-  Stops playback or recording.
-  Skips to the next or previous chapter/track.
-  Starts recording. Press repeatedly to set the recording time. For more details, Refer to One Touch Record (OTR) on page 46.
-  Increases or decreases the slow motion speed when playing a DVD or VHS tape.



	Selects Recording mode: - DVD : Approx 1 Hour (HQ mode), 2 Hours (SP mode), 4 Hours (EP mode), 8 Hours (SEP mode) - VCR : SP or LP.
	Selects an audio language (DVD), audio channel (CD) or audio type (TV).
	Selects a subtitle language, if available.
	Repeats the current chapter, track, title or the entire disc.
	Repeats playback between two points (A and B).
	Displays a disc's Title menu, if available.
	Enlarges the DVD video image.
	Selects a DVD camera angle, if available.
	Resets the tape counter in VCR mode.
	Displays the Timer Recording menu.
	Displays digital text of the programme
	Disc Operation options
	Switches the DVB-T VCR/DVD Recorder input to TV tuner, AV1, AV2, FAV or DV.

Progressive Scan Mode

- As component outputs have their own Jacks on the back side, change the TV input into Component input, after connecting the component cables from the DVB-T VCR/DVD Recorder to TV.
- Changing from Interlace or Progressive to RGB, should be the opposite of above.

CONSUMERS SHOULD NOTE THAT NOT ALL HIGH DEFINITION TELEVISION SETS ARE FULLY COMPATIBLE WITH THIS PRODUCT AND MAY CAUSE ARTIFACTS TO BE DISPLAYED IN THE PICTURE. IN THE CASE OF 576 PROGRESSIVE SCAN PICTURE PROBLEMS, IT IS RECOMMENDED THAT THE USER SWITCH THE CONNECTION TO THE 'STANDARD DEFINITION' OUTPUT. IF THERE ARE QUESTIONS REGARDING OUR TV SET COMPATIBILITY WITH THIS MODEL, PLEASE CONTACT OUR CUSTOMER SERVICE CENTRE.

Rear panel

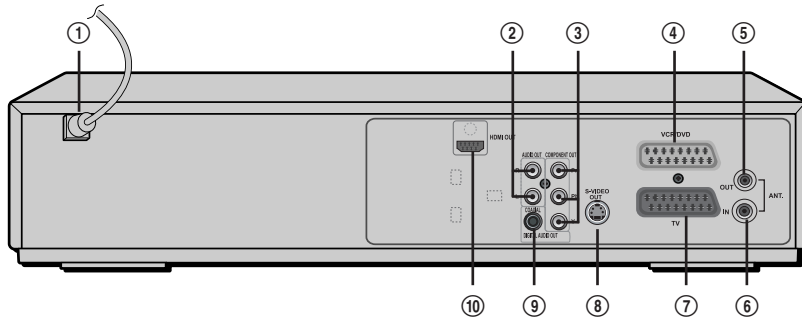

① **AC Power Cord**

Plug into a power outlet.

② **AUDIO OUT (L, R)**

Connect to a TV or other equipment with audio inputs.

③ **COMPONENT VIDEO OUT (Y Pb Pr)**

Connect to a TV with Component Video (Y Pb Pr) inputs.

④ **Scart socket 2**

Connection of an additional device (satellite receiver, set-top box, video recorder, camcorder, etc.)

⑤ **RF OUT (TO TV)**

Connect to a TV with an RF input.

⑥ **RF IN (FROM ANT.)**

Connect to your antenna or cable TV outlet.

⑦ **Scart socket 1**

Connection of a TV set. Composite-output and RGB-output

⑧ **S-VIDEO OUT**

Connect to a TV with an S-Video Input.

⑨ **COAXIAL (Digital Audio Out)**

Connect to an amplifier with a coaxial digital audio input.

⑩ **HDMI OUT**

HDMI output providing a high quality interface for digital audio and video.

 **Caution**

- Do not touch the inner pins of the jacks on the rear panel. Electrostatic discharge may cause permanent damage to the DVB-T VCR/DVD Recorder.

Connections



To enable you to set up your new DVB-T VCR/DVD recorder, it must be connected to your TV using either a SCART cable or a COMPONENT (or S-Video) and associated AUDIO cable. If a unit has HDMI connection, you can use a HDMI cable as well.



- There are a variety of ways to connect the DVB-T VCR/DVD Recorder to your TV and other equipment. Use only one of the connections described below. Whichever TV connection you use will work with all input sources.
- Please refer to the manuals for your TV, VCR, stereo system, or other devices as necessary to make the best connections.
- For better sound reproduction, connect the DVB-T VCR/DVD Recorder's AUDIO OUT jacks to the audio in jacks of your amplifier, receiver, stereo, or audio/video equipment. See 'Connecting an Amplifier/Receiver' on page 19.



Caution

- Make sure the DVB-T VCR/DVD Recorder is connected directly to the TV, and the TV is set to the correct video input.
- Do not connect the DVB-T VCR/DVD Recorder's AUDIO OUT jack to the phone in jack (record deck) of your audio system.
- Do not connect the unit through a VCR. Video signals fed through VCRs may be affected by copyright protection systems and the picture will be distorted on the television.

Connecting Antenna/Cable

- 1 Disconnect the antenna/cable from the rear of your TV.
- 2 Connect this cable to the jack marked ANT IN (FROM ANT.) on the rear panel of the DVB-T VCR/DVD Recorder.

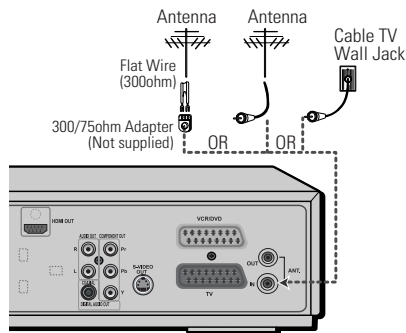

Rear of DVB-T VCR/DVD Recorder

Connecting a TV

Choose one of the following TV connections, depending on the capabilities of your equipment.

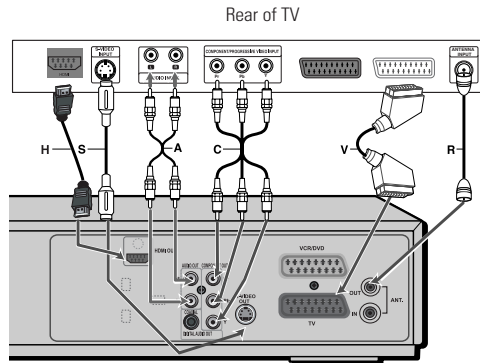

Rear of DVB-T VCR/DVD Recorder

RF Connection

Connect the ANT OUT (TO TV) jack on the DVB-T VCR/DVD Recorder to the antenna in jack on your TV using the supplied 75-ohm RF cable (R).



This set doesn't have a modulator output. However it still supplies the RF loopthrough Output.

Scart Connection

- 1 Plug a scart cable into the scart socket TV (EURO AV1) at the back of the DVB-T VCR/DVD Recorder and the corresponding scart socket at the back of the TV set. (V)
- 2 Plug a scart cable into the top scart socket VCR/DVD (EURO AV2/DECODER) at the back of the DVB-T VCR/DVD Recorder and the corresponding scart socket at the back of the Decoder.

S-Video Connection

- 1 Connect the S-VIDEO OUT jack on the DVB-T VCR/DVD Recorder to the S-Video in jack on your TV using an S-Video cable (S).
- 2 Connect the Left and Right AUDIO OUT jacks from the DVB-T VCR/DVD Recorder to the left/right audio in jacks on your TV using the audio cables.

Component Video Connection

- If your television is a high-definition or 'digital ready' television, you may take advantage of the DVB-T VCR/DVD Recorder's Progressive Scan output for the highest video resolution possible.
 - If your TV does not accept the Progressive Scan format, the picture will appear scrambled.
- 1 Connect the COMPONENT VIDEO OUT jacks on the DVB-T VCR/DVD Recorder to the corresponding jacks on your TV using a Y Pb Pr cable (C) if the component (Y, Pb, Pr) is available on your TV.
 - 2 Connect the Left and Right AUDIO OUT jacks of the DVB-T VCR/DVD Recorder to the left/right audio jacks on your TV using the audio cables.



- When you use component video connection, you can change the resolution (576i, 576p) for the component output by setting the video output option in the setup menu (See page 31).
 - Interlaced mode : 576i
 - Progressive mode : 576p
- Progressive Scan does not work with the RF, Audio/Video or S-Video connections.



- When you use the HDMI connection, the audio's sampling frequency is outputted only with 48KHz even if you select [96KHz].
- This recorder does not perform internal (2 channel) decoding of a DTS sound track. To enjoy DTS multi channel surround sound, you must connect this recorder to a DTS compatible receiver via one of this recorder's digital audio outputs.
- No sound will be output from the HDMI cable if the Digital out option is not set to 'PCM' on the Setup menu (See page 31).
- The arrow on the cable connector body should face up for correct alignment with the connector on the recorder.
- If there is noise or lines on the screen, please check the HDMI cable.
- When you use HDMI connection, you can change the resolution (576i, 576p, 720p, 1080i) for the HDMI output by setting the video output option in the setup menu (See page 31).
 - RGB : 576i
 - Interlaced mode : 576i, 1080i
 - Progressive mode : 576p, 720p
- Changing the Progressive Scan mode when the recorder is connected with HDMI connector may result in malfunctions. To solve the problem, turn off the recorder and then turn it on again.

HDMI connection

If you have a HDMI TV or monitor, you can connect it to this recorder using a HDMI cable.

- 1 Connect the HDMI jack on the recorder to the HDMI jack on a HDMI compatible TV or monitor (H).
- 2 Set the TV's source to HDMI (refer to TV's Owner's manual).

Connecting an Amplifier/Receiver

Connecting to an amplifier equipped with two channel analogue stereo or Dolby Pro Logic II/Pro Logic

Connect the Left and Right AUDIO OUT jacks on the DVB-T VCR/DVD Recorder to the left and right audio in jacks on your amplifier, receiver, or stereo system, using the audio cables (A) (Audio cables are not supplied with this product).

Connecting to an amplifier equipped with two channel digital stereo (PCM) or to an Audio/Video receiver equipped with a multi-channel decoder (Dolby Digital™, MPEG 2, or DTS)

- 1 Connect the DVB-T VCR/DVD Recorder's DIGITAL AUDIO OUT jack (Coaxial) to the corresponding in jack on your amplifier. Use an optional digital coaxial audio cable. (X)
- 2 You need to activate the DVB-T VCR/DVD Recorder's digital output; see 'Digital Audio' Settings on page 31.

Digital Multi-Channel Sound

A digital multi-channel connection provides the best sound quality. For this you need a multi-channel audio/video receiver that supports one or more of the audio formats provided by your DVB-T VCR/DVD Recorder (MPEG 2, Dolby Digital, and DTS). Check the receiver manual and the logos on the front of the receiver.

- Due to the DTS Licensing agreement, the digital output will be in DTS digital out when the DTS audio stream is selected.
- If the audio format of the digital output does not match the capabilities of your receiver, the receiver will produce a strong, distorted sound or no sound at all.
- 5.1 channel digital surround sound via the digital connection can only be obtained if your receiver is equipped with a digital multi-channel decoder.
- To see the audio format of the current DVD on the on-screen display, press [AUDIO].

The DVB-T VCR/DVD Recorder does not perform internal (2-channel) decoding of DTS sound tracks. To enjoy DTS multi-channel surround, you must connect the DVB-T VCR/DVD Recorder to a DTS compatible receiver via one of the DVB-T VCR/DVD Recorder's digital audio outputs.

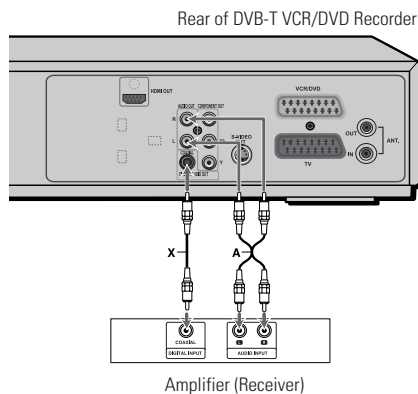

CONNECTIONS

Connecting Optional Equipment

To receive audio/video signals from other equipment, connect the AVF (Audio/Video Front) jacks on the DVB-T VCR/DVD Recorder to the audio/video out jacks on your external component, using optional audio/video cables.

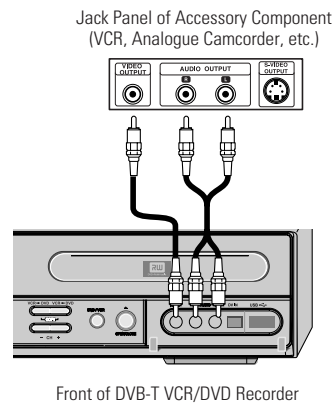

Connecting to USB

Using the USB input connector, you can use a USB memory stick as the playable media.

JPEG, MP3 and DivX media files can be played from USB memory.



- Only MP3 Player (or Digital Camera) which doesn't need to install Driver software are available for this DVB-T VCR/DVD Recorder.
- It is impossible to copy the JPEG or MP3 file in a Digital camera or mp3 player to the DVD or VCR.

MP3 Player or Digital Camera

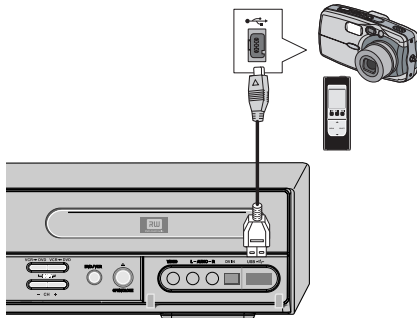

Front of DVB-T VCR/DVD Recorder

Connecting a Digital Camcorder

Using the front panel DV IN jack, it is possible to connect a DV digital camcorder, video deck or DVD+R/RW recorder and digitally transfer DV tapes or DVD+R/RW discs to DVD±R or DVD±RW.

Use a DV cable (not supplied) to connect the DV In/Out jack of your DV camcorder/video deck to the front panel DV IN jack of the DVB-T VCR/DVD Recorder.



This jack is for connection to DV equipment only. It is not compatible with digital satellite tuners or D-VHS video decks.

DV Digital Camcorder

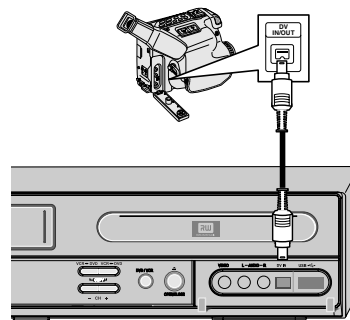

Front of DVB-T VCR/DVD Recorder

Initial Installation

After successfully connecting your DVB-T VCR/DVD Recorder to your TV and other devices, this chapter will show you how to complete the initial installation.

 You must follow the initial installation process to set the time, date, channels, and language preferences for the DVB-T VCR/DVD Recorder.

- 1** Switch on your DVD recorder. An 'Auto Tune' message is displayed on the screen. Press the [RED] button to start auto tune.
- 2** The DVB-T VCR/DVD Recorder detects channels automatically and stores them in the memory.
- 3** After finishing Auto Channel Search, save the settings by pressing the [GREEN] button.
- 4** If you cancel the process during Initial Installation, you should repeat this procedure.

Re-Installation

- 1** Press [SETUP] and select the 'Restore Default Settings' using [▲/▼/◀/▶]. Then select 'YES' to reset the set (see page 36).
- 2** Power On, then you will see the 'Initial Installation'.
- 3** Repeat the steps 1~3 opposite.

CONNECTIONS

SETUP

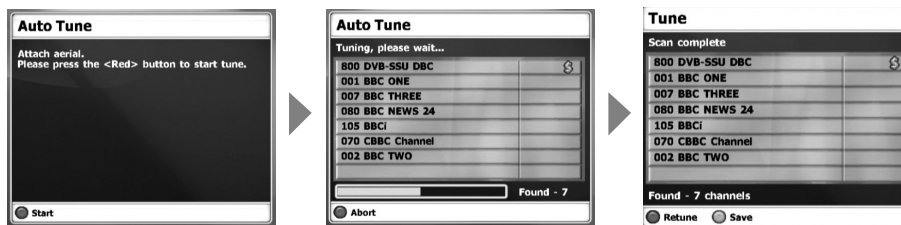

Guide to Digital Services

EPG (Electronic Programme Guide)

The EPG provides a quick and easy way to:

- View a complete list of all available channels.
- View a channel list related to a chosen category.
- Set a programme to be recorded (page 50).

1 Press [EPG] to display the EPG.

This display consists of an information box and a 6 channel programme list covering a one hour period.

Example of EPG Display:



- ① Channel number and name.
- ② Indicates the currently highlighted programme and allows you to move around the list.
When this bar is red, it means that a timer recording is associated to the event. (page 50)
- ③ Current TV channel display
- ④ Coloured Control button
- ⑤ Indicates the current time and date
- ⑥ Time Duration
- ⑦ Truncated programme title in case the name is too long to be displayed in the cell.
- ⑧ Programme information for the cursor positioned.

2 You can continue to watch the current programme on a small TV picture of the current selected programme before the EPG was pressed in the bottom half of the screen.

3 Press [▲/▼/◀/▶] to move around the list.

If you press the ▶ button after highlighting the last programme on the right, the schedule for the next one hour is displayed (depending on availability from the broadcaster).

4 Press [RED] to record the programme. (refer to page 50)

5 Press [BLUE] to display the next day or [YELLOW] to display the previous day.

6 Press [OK] to Select to view a programme on at the current time. This will exit the EPG automatically.

7 Or if not selecting a programme, press [EPG] or [BACK] to exit .



Note

- If you press [▲/▼/◀/▶] on the remote control when the EPG is on display, you have the option to view the programme schedule 24 hours in advance. (when available)
- The time range can be moved up to 8 days from the current time.

Viewing programmes using Category Search

This feature allows you to search for programmes related to a particular topic.

For example, if you select "Sports" from the category search list, then only programmes related to Sports will be shown in the EPG.



Note

The category of each programme is determined by the broadcaster.

- 1 Press [EPG] to display the EPG.
- 2 Press [GREEN]. The category search list appears.



- 3 Use [▲/▼] to highlight the category you want, then press [RED] to begin search.

The Search Results are displayed and only programmes related to that category will be shown in the list.



Note

This unit offers 11 category types, including: Movies/Drama, Current Affairs, Game Shows, Sports, Kids, Music/Dance, Arts/Culture, Social/Political, Educational/Science, Leisure and Special Interest.

- 4 Press [▲/▼] to highlight the programme you wish to view, then press [OK].



Note

If you want to go to the previous mode, press [BACK] on the remote control.

Viewing programmes using Keyword Search

This feature allows you to search for programmes related to particular words.

For example, if you enter "Mad about you" in the Keyword Search mode, then only programmes related to the keyword "Mad about you" will be shown in the EPG.

- 1-2 Follow steps 1-2 as shown under 'Viewing channels using Category Search'.

- 3 Press [GREEN] button. The Keyword Search will be displayed.



- 4 Enter the Keyword related to the program you wish to view.

The Search Result is displayed and only programmes related to that keyword will be shown in the list.

• On the remote control

◀, ▶, ▲, ▼ : moves the cursor to the desired position.

OK: enter the character

RED: starts the search function.

• On the Search Result screen

CLEAR: clear all

BACK: clear the last character.

- 5 Press [▲/▼] to highlight the programme you wish to view, then press [OK].

• On the remote control

RED: this will set a timer for the selected programme.

GREEN: this will perform a new search from step 2.

Information Service

Many digital TV channels broadcast information via their text service. This digital service includes high quality digital text and graphics along with advanced navigation options. Additionally, this recorder has access to dedicated text channels transmitted by the broadcasters.



- The appearance, content and navigation methods of all digital text services are decided by the broadcaster.

Selecting digital text from dedicated digital teletext channels

1 Select a dedicated channel that is broadcasting digital text.

If you do not know the number of a dedicated digital text channel, you can use the 'Electronic Programme Guide' by pressing the [EPG] to find one (page 22).

2 Once the text page is displayed (this may take some time), follow the on-screen instructions to obtain your required selection.

On some pages the TV programme may also be displayed on the text screen. On-screen instructions will inform you how to use the displayed programme.

3 When you have finished viewing the text service, follow the on screen instructions to exit.

Selecting digital text from other channels

Digital text services may also be available on other digital channels. This is sometimes indicated by a small symbol on your TV screen, superimposed on the programme you are watching.

1 Select a channel.

2 Press [TEXT] or the button indicated on screen by the broadcaster.

3 Once the text information is displayed, you can access required information by using the [▲/▼/◀/▶], the coloured buttons and/or the numbered buttons on the remote control.

4 When you have finished viewing the text services displays, follow the on screen instructions to exit.

Setup menu

Setup Menu Overview

The DVB-T VCR/DVD Recorder Setup menu includes 7 categories, including: Installation, Record/Play Options, Languages, Preferences, Parental Settings, System Info, and Update/Restore. Press [SETUP] and [◀/▶] on the remote control to view the first and second levels of the Setup menu.

■ SETUP

- contains the following sub menu's :

- 1 Installation - lets you tune and change how programmes are displayed on your TV. Also you can set or modify the clock of the system.
- 2 Record/Play Options - lets you select the desired recording/VCR play options.
- 3 Languages - when a programme is broadcast in multiple languages, this lets you choose the language you listen to and any on-screen text or subtitles that are displayed.
- 4 Preferences - allows you to adjust items related to the image and sound.
- 5 Parental Settings - lets you control what can be watched. Please refer to the relevant section in this guide for more information.
- 6 System Info - as the name suggests lists the current version of software installed in this unit.
- 7 Update/Restore - allows you to set the software update and reset the DVB-T VCR/DVD Recorder to its original factory settings.

Menu Navigation

- 1 Press [SETUP]. The Setup menu appears.
- 2 Use [◀/▶] to select the desired category.
- 3 While the desired category is selected, press [▲/▼] to move to the second level.
- 4 Press [OK] to move to the third level.
- 5 Use [▲/▼] to select the desired setting, then press [OK] to confirm your selection.

Some items require additional steps. Press [SETUP] at any time to return to the previous menu.

- 6 Press [SETUP] to exit the Setup menu.

INSTALLATION Settings

Auto Tune

The DVB-T VCR/DVD Recorder has a frequency synthesized tuner capable of receiving channels that include UHF E21-E69.

If the Initial Installation ends without result, you should repeat this procedure.

Preparation:

Connect the DVB-T VCR/DVD Recorder to the desired type of antenna or cable TV system, as shown in 'Connecting Antenna/Cable' on page 16.

- 1 Press [SETUP]. The Setup menu appears.
- 2 Use [◀/▶] to select 'Installation'.
- 3 While 'Installation' is selected, press [▼] to select 'Auto Tune', and press [OK].

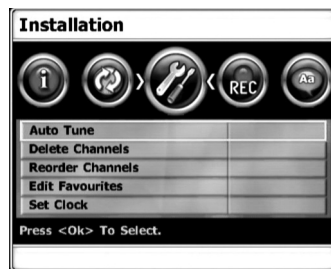

- 4 Press [RED], start to begin the channel search. The tuner will automatically search for all available channels in your area and place them in the tuner's memory.



- 5 Press [GREEN] to save the channel search results. Press [RED] to retune again; see page 21 for more details.

Delete Channels

After tuning TV or Radio stations into your DVB-T VCR/DVD Recorder, you may wish to delete a station.

- 1 Press [SETUP]. The Setup menu appears.
- 2 Use [◀/▶] to select 'Installation'.
- 3 Use [▲/▼] to select 'Delete Channels'.

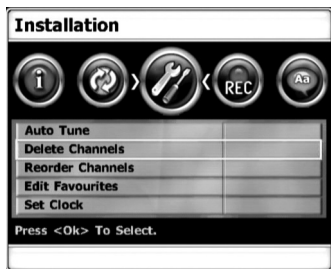

- 4 Press [OK]. Press [▲/▼] to select the channel you want to delete, then press the RED button to confirm it.

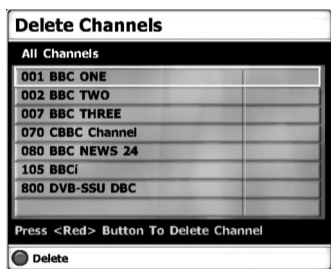

Reorder Channels

After tuning TV or Radio stations into your DVB-T VCR/DVD Recorder, you may wish to change the order of the stations you have in your set to your preference.

- 1 Follow steps 1-2 as shown under 'Delete Channels'.
- 2 Use [▲/▼] to select 'Reorder Channels'.

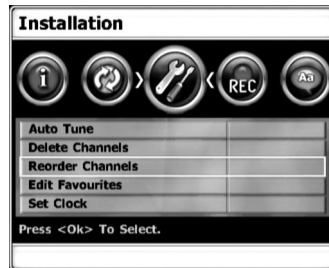

- 3 Press [OK]. Press [▲/▼] to select the service you want to align, then press the RED button to confirm it.



- 4 Press [▲/▼] to move the selected service to the position you want, then press the RED button to finish placing.

Edit Favourites

After tuning TV or Radio stations into your recorder, you may store or edit your favourite channels into TV or Radio lists.

- 1 Follow steps 1-2 as shown under 'Delete Channels'.
- 2 Use [▲/▼] to select 'Edit Favourites'.

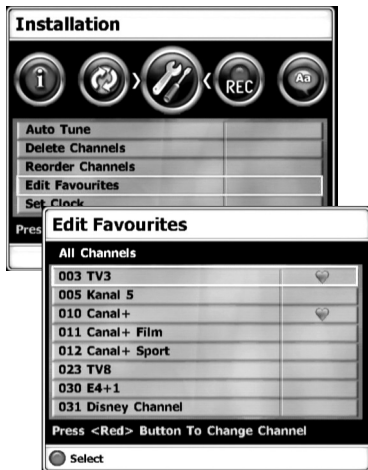

- 3 Press [OK]. Press [▲/▼] to select the service you want to edit, then press the [RED] button to confirm it. A channel selected as a favourite is identified by a heart icon next to the programme name.
- 4 If you want to delete the channel from your favourite list, select the channel by using [▲/▼] and press [RED]. To exit this screen mode, press [BACK].

Usage of LIST button

You can bring up the list of broadcasting channels any time by pressing [LIST] on the remote control.

- 1 Press [LIST] on the remote control.
- 2 'Channel List' screen displays. Use [◀/▶] to select 'All Channels', 'Radio Channels' or 'Favourite List'.
- 3 Press [OK] to select the channels.

Set Clock

You can set or modify the system clock.

- 1 Follow steps 1-2 as shown under 'Delete Channels'.
- 2 Use [▲/▼] to select 'Set Clock'.

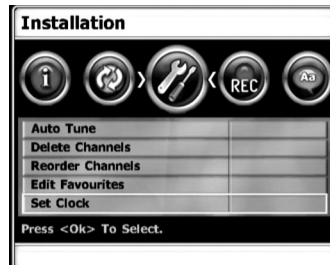

- 3 Press [OK]. The 'Set Clock' menu appears.

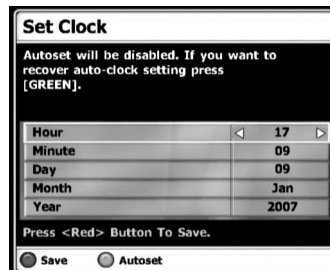

- 4 If you want to set the date and time manually,
 - ◀/▶ (left/right): Changes the setting at the current cursor position.
 - ▲/▼ (up/down): Moves the cursor to the previous or next line.
- 5 Press the RED button to save your setting, then press [SETUP] to exit the Setup menu.



Auto Set

Once you change the date and time, your VCR/DVD Recorder won't get the auto clock information provided by broadcasters. If you want to recover the Auto Clock Information, press [Green]. Your VCR/DVD Recorder will get the Auto Clock setting again. After finishing Auto set, press [Red] to save the setting and press [SETUP] to exit the setup menu.

RECORD/PLAY OPTIONS Settings

DVD Record Quality

You can set the default DVD recording quality to (Approx. time) : HQ (High Quality - 1 hr/disc), SP (Standard Play - 2 hrs/disc), EP (Extended Play - 4 hrs/disc), or SEP (Super Extended Play - 8 hrs/disc).

- 1 Press [SETUP]. The Setup menu appears.
- 2 Use [◀/▶] to select 'Record/Play Options'.
- 3 Whilst 'Record/Play Options' is selected, press [▼] to select 'DVD Quality'.
- 4 Use [◀/▶] to select the desired Record Quality (HQ, SP, EP, or SEP).
- 5 Press [SETUP] to exit the menu.



VCR Record Quality

You can set the VCR recording quality to SP (Standard Play; 3 Hours on 180min cassette), LP (Long Play; 6Hours on 180min cassette).

Follow the same procedure as for 'DVD' record quality, however select 'VCR' quality in step 3.



Hot button

- You can set the default DVB-T VCR/DVD recording quality using [REC Mode] button of the remote control.

- [REC MODE] button is a toggle button of HQ/SP/EP/SEP in DVD mode and SP/LP in VCR mode.

Auto Chapter

During recording, chapter markers are added automatically at fixed intervals. You can set this interval to 5 minutes, 10 minutes or 15 minutes. To turn off automatic chapter marking, select 'Off'.

Follow the same procedure as for 'DVD Record Quality', however select 'Auto Chapter' in step 3.



VCR Search

This feature enables you to search for index marks or specific times on your VHS tapes.

- 1 Press [SETUP]. The Setup menu appears.
- 2 Use [◀/▶] to select 'Record/Play Options'.
- 3 Whilst 'Record/Play Options' is selected, press [▼] to select 'VCR Search'.
- 4 Select 'Index+', 'Index-' or 'Go To Zero' using [◀/▶], and press [OK]. If you select 'Index+' (or 'Index-') and press [OK], your DVB-T VCR/DVD Recorder will locate your index mark and begin playback. If you select 'Go To Zero' and press [OK], your DVB-T VCR/DVD Recorder will wind to the position 0:00:00 and stop.
- 5 Press [SETUP] to exit the menu.



LANGUAGES Settings

OSD Language

The OSD Language is fixed in 'English'.

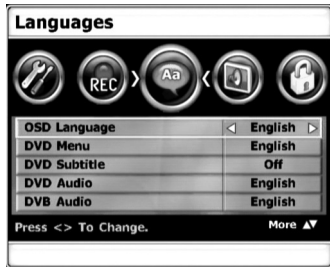

DVD Menu/ DVD Subtitle/ DVD Audio Language

Select your preferred language for DVD Menus, DVD Subtitles, and DVD Audio soundtracks.

- 1 Press [SETUP]. The Setup menu appears.
- 2 Use [◀] and [▶] to select 'Languages'.
- 3 Whilst 'Languages' is selected. Press [▼] to select 'DVD Menu' or 'DVD Subtitle' or 'DVD Audio'.
- 4 Use [◀/▶] to select the desired language.
- 5 Press [SETUP] to exit the menu.

DVB Audio/ DVB Subtitles / EPG Language and DVB Subtitles mode

Select a language for the DVB-T VCR/DVD Recorder Setup menu and on-screen displays.

- 1 Press [SETUP]. The Setup menu appears.
- 2 Use [◀] and [▶] to select 'Languages'.
- 3 Whilst 'Languages' is selected. Press [▼] to select 'DVB Audio', 'DVB Subtitles', 'DVB Subtitles mode' or 'EPG Language'.
- 4 Use [◀/▶] to select the desired language.
- 5 Press [SETUP] to exit the menu.

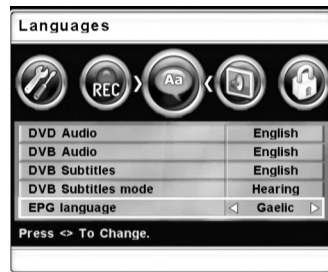

- **DVB Audio:** switches the language broadcasted by a digital channel.
- **DVB Subtitles Language:** switches the language of the subtitles broadcasted by a digital channel (when available).
In order to see DVB subtitle language selection field, you have to move the cursor down by the up/down button.

PREFERENCES Settings

TV Aspect Ratio

- 1 Press [SETUP].
- 2 Use [◀/▶] to select 'Preferences'.
- 3 Whilst 'Preferences' is selected, press [▼] to select 'Television'.
- 4 Use [◀/▶] to select the desired TV Aspect ratio.
- 5 Press [SETUP] to exit the menu.

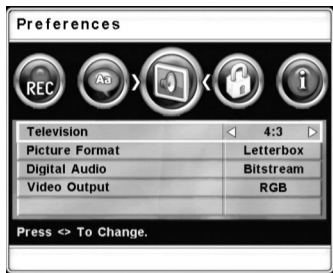

- **4:3** : Select when a standard 4:3 TV is connected.
- **16:9** : Select when a 16:9 wide screen TV is connected.

Picture Format

- 1 Press [SETUP].
- 2 Use [◀/▶] to select 'Preferences'.
- 3 While 'Preferences' is selected, press [▼] to select 'Picture Format'.
- 4 Use [◀/▶] to select the desired Picture Format.
- 5 Press [SETUP] to exit the menu.



If Television setting is set to "16:9", the picture format is always fixed to "Auto".

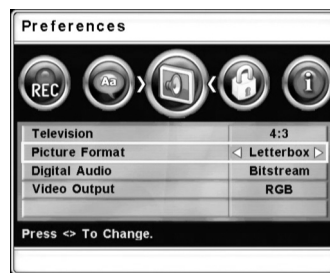

- **Letter Box** : Displays theatrical images with masking bars above and below the picture.



- **Centre** : Displays pictures cropped to fill your TV screen. Both sides of the picture are cut off.



- **Auto** : Converts to the appropriate aspect ratio automatically.

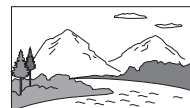

Digital Audio

- 1 Press [SETUP].
- 2 Use [◀/▶] to select 'Preferences'.
- 3 Whilst 'Preferences' is selected, press [▼] to select 'Digital Audio'.
- 4 Use [◀/▶] to select the desired digital output type.
- 5 Press [SETUP] to exit the menu.

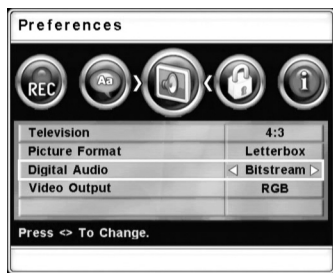

• Off

No signal will be output from the Digital Audio Out jacks.

• PCM

Select when connected to a 2 channel digital stereo amplifier. The DVB-T VCR/DVD Recorder's digital audio signal will be output in the PCM 2ch (Pulse Code Modulation 2 Channel) format when you play a DVD recorded with a Dolby Digital (only for DVD) or MPEG soundtrack. If the DVD is recorded with a DTS (Digital Theatre Surround) sound track then no sound will be heard.

• Bitstream

If your DVD is recorded with a DTS sound track then select Bitstream when connected to a Dolby Digital or DTS decoder (or an amplifier or other equipment with a Dolby Digital or DTS decoder).

Video Output

Progressive Scan Video provides the highest picture quality with reduced flickering.

RGB : If the DVB-T VCR/DVD Recorder is in RGB mode, you can watch RGB signal by connecting the recorder to an analogue television using the SCART jacks.

Interlace (576i) or Progressive (576p) : If you connect the DVB-T VCR/DVD Recorder to a digital television (DTV) or Monitor using the COMPONENT jacks, set Video Output to '576i' or '576p' (i : Interlaced scan mode, p : Progressive scan mode).

- 1 Press [SETUP].
- 2 Use [◀/▶] to select 'Preferences'.
- 3 While 'Preferences' is selected, press [▼] to select 'Video Output'.
- 4 Use [◀/▶] to select the desired Video Output mode.
- 5 Press [SETUP] to exit the menu.

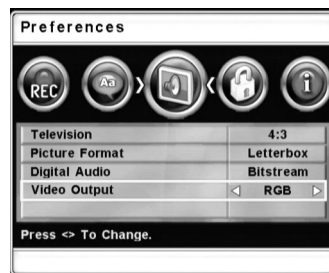

When you use the HDMI connection, you can change the resolution (576i, 576p, 720p, 1080i) for the HDMI output by setting the video output option in setup menu.

Parental Settings

Rating Level

The Parental Settings feature allows you to prevent DVDs from being played based on their ratings or to have certain discs played with alternative scenes. You can set the Rating Level from 'OFF' to 'U' to a maximum '18R'.

- 1 Press [SETUP].
- 2 Use [◀/▶] to select 'Parental Settings'.
- 3 Whilst 'Parental Settings' is selected, press [▼] to select 'Rating Level'. The Password Input dialog will appear. Enter a 4-digit password using the [0-9] buttons.

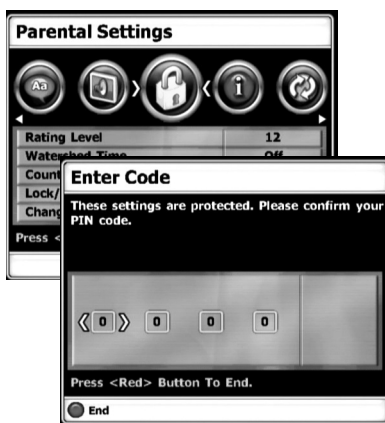

- 4 If this is the first time you have entered a password, you will be prompted to enter the password again to confirm it.

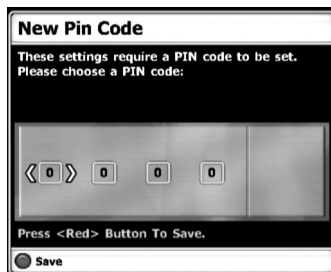

 The initial password is '0000'. You must enter this password before you can change the Parental Level.



Set the new password to something other than '0000'.

- 5 After setting the password, press the Red button to end. Then the 'Parental Setting' screen is displayed.

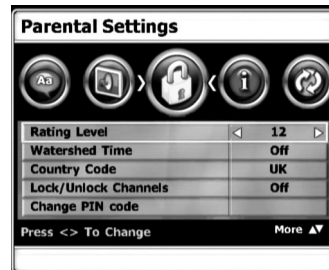

- 6 Use [◀/▶] to select the desired rating level.

Off: If you select Unlock, the Lock feature is not active. All discs will play in full.

U (Universal) to 18R (Adult): Some discs contain scenes not suitable for children. If you set a rating for the DVB-T VCR/DVD Recorder, all scenes with the same rating or lower will be played. Higher rated scenes will not be played unless an alternative scene is available on the disc. The alternative must have the same rating or a lower one. If no suitable alternative is found, playback will stop. You must enter the 4-digit password or change the rating level in order to play the disc.

There are 9 rating Levels, including: Kids, U, PG, 12A, 12, 15, 18, 18R and Off.

- 7 Press [SETUP] to exit the menu.

Watershed Time

For children, you may also use the watershed time function.

When the watershed time function starts, only a black screen appears.

- 1 Follow steps 1-3 as shown under 'Rating Level'.
- 2 Use [▲/▼] to select 'Watershed Time'.
- 3 Use [◀/▶] to select the desired watershed time.

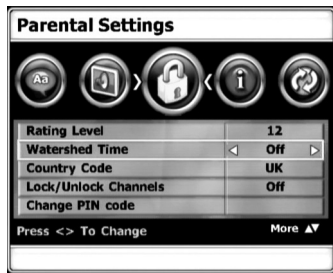

You can select a watershed time in 30 minute steps. (from 6 p.m. to 11:59 p.m.)



- If it is canceled by entering the correct parental code, the cancellation is only valid until the next day watershed time.
- For the permanent cancellation, the user has to set it to 'off' in the parental settings.
- Factory default is 'off'.

Country Code

- 1 Press [SETUP].
- 2 Use [◀/▶] to select 'Parental Settings'.
- 3 Whilst 'Parental Settings' is selected, press [▼] to select 'Rating Level'. The Password Input dialog will appear. Enter a 4-digit password using the [0-9] buttons.
- 4 Use [▼] to select 'Country Code'.
- 5 Use [◀/▶] to select the desired country code. N.B. As the film classification ratings are slightly different in each country, we recommend that country code is set to 'UK' for use in the UK area.

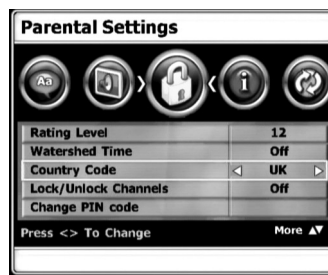

SETUP

Lock/Unlock Channels

- 1 Follow steps 1-3 as shown under 'Country Code'.
- 2 Use [▲/▼] to select 'Lock/Unlock Channels'.
- 3 Press [OK] to enter into 'Lock/Unlock Channels' screen.
- 4 Use [▲/▼] to select channels you want to lock.
- 5 Press [RED] to toggle Lock/Unlock status.
- 6 After you finish the setting, press [BACK] to go back to exit.

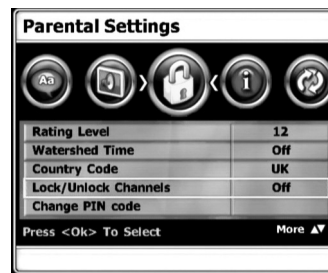

Change PIN code

- 1 Follow steps 1-3 as shown under 'Country Code'.
- 2 Use [▲/▼] to select 'Change PIN code'.
- 3 Press [OK] to select the Change PIN code mode.



- 4 The 'Change Pin Code' screen appears. Enter your new 4-digit password.
- 5 To confirm the new password, press the Red button.



- **Master Password :** If you forget your password, press 3,3,0,8 on the remote control and then press [ENTER].
- Set the new password to something other than '0000'.

SYSTEM Info

Firmware Info

System Information helps service personnel identify firmware information about your DVB-T VCR/DVD Recorder in case service is required.

- 1 Press [SETUP]. The Setup menu appears.
- 2 Use [◀] and [▶] to select 'System Info'.
- 3 Use [▲/▼] to select 'Firmware Info'.
- 4 Press [OK] to select the Firmware Info.
- 5 Firmware Info screen appears as below.

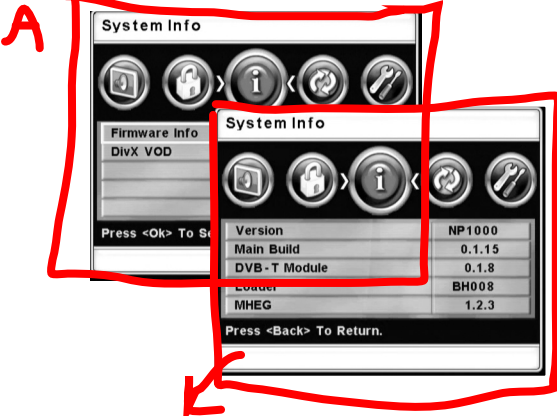

DivX VOD

- 1 Follow steps 1-2 as shown under 'Firmware Info'.
- 2 Use [▲/▼] to select 'DivX VOD'.
- 3 Press [OK] to select the DivX VOD.
- 4 DivX VOD screen appears as below.

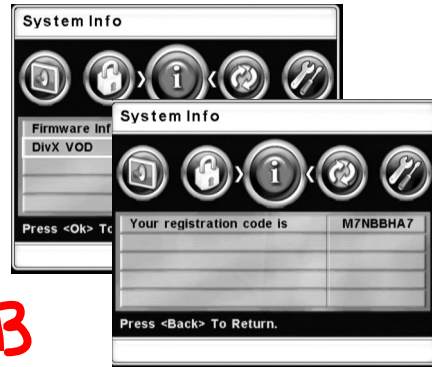

We provide you the DivX® VOD (Video On Demand) registration code that allows you to rent and purchase videos using the DivX® VOD service. For more information, visit www.divx.com/vod.

Update/ Restore

Software Update

If you wish, you can check for software updates.

- 1 Press [SETUP]. The Setup menu appears.
- 2 Use [◀] and [▶] to select 'Update/ Restore'.
- 3 While 'Update/Restore' is selected, press [▼] to select 'Check For Software Update'.
- 4 Press [OK] to set the 'Check For Software Update'.



Restore Default Settings

If you wish, you can reset the DVB-T VCR/DVD Recorder to its original factory settings.

- 1 Press [SETUP]. The Setup menu appears.
- 2 Use [◀] and [▶] to select 'Update/ Restore'.
- 3 While 'Update/Restore' is selected, press [▼] to select 'Restore Default Settings'.
- 4 Press [OK] to select the 'Restore Default Settings'.



- 5 Use [▶] to select 'YES'. Then DVB-T VCR/DVD Recorder is reset to its original factory settings.



- Some options cannot be reset, including Parental Controls, Password, and Country Code.
- After Restoring Defaults, the unit is powered off automatically. At this time, if you power on again, the Installation menu appears.

On-Screen Display Overview

The On-Screen Display provides feedback on the status of the DVB-T VCR/DVD Recorder and/or the currently loaded disc. To access the On-Screen Display (or OSD), press [INFO].

Displaying Disc Information

To display information about the currently loaded disc:

On-screen display operation

- Press [INFO] once during playback.

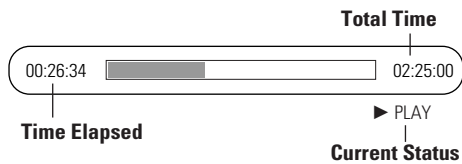

- Press [INFO] twice during playback.

- 1 Press [INFO] twice to display the information displayed on-screen.
- 2 To remove the on-screen display, press [INFO] three times.

See the descriptions below for detailed explanations of the on-screen displays for each media type.



Some discs may not provide all the features shown in the on-screen display examples.

Temporary Feedback Icons

- ⊘ Action prohibited or not available

Disc Information options for DVD

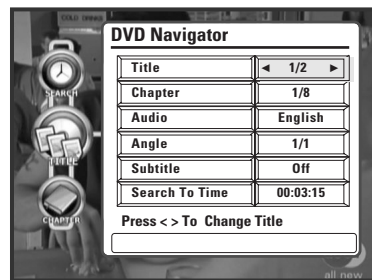

Title

Shows the current title number and total number of titles, and skips to the desired title number.

- 1 Press [INFO] twice during playback. The on-screen display appears on the TV screen.
- 2 Then 'Title' line is already selected.
- 3 Use [◀/▶] to change the title numbers.

Chapter

Shows the current chapter number and total number of chapters, and skips to the desired chapter number.

- 1 Press [INFO] twice during playback. The on-screen display appears on the TV screen.
- 2 Use [▲/▼] to select the 'Chapter' line on the on-screen display.
- 3 Use [◀/▶] to change the chapter numbers.

Audio

Shows the current audio soundtrack language and changes the setting.

- 1 Press [INFO] twice during playback. The on-screen display appears on the TV screen.
- 2 Use [▲/▼] to select the 'Audio' line on the on-screen display.
- 3 Use [◀/▶] to select the desired audio language.

SETUP

Angle

Shows the current angle number and total number of angles, and changes the angle number.

- 1 Press [INFO] twice during playback. The on-screen display appears on the TV screen.
- 2 Use [▲▼] to select the 'Angle' line on the on-screen display.
- 3 Use [◀▶] to change the angle numbers.

PBC

Shows the current PBC status, and changes the setting. PBC is PlayBack Control used for VCD, SVCD, and some DVDs.



Angle and PBC appears in the navigator according to the type of media.

Subtitle

Shows the current subtitle language, and changes the setting.

- 1 Press [INFO] twice during playback. The on-screen display appears on the TV screen.
- 2 Use [▲▼] to select the 'Subtitle' line on the on-screen display.
- 3 Use [▲▼] to select the desired subtitle language.

Elapsed time/ Search To Time

Shows the elapsed playing time, and skips to the desired time.

- 1 Press [INFO] twice during playback. The on-screen display appears on the TV screen.
- 2 Use [▲▼] to select the 'Search To Time' line on the on-screen display. You can see the elapsed playing time.
- 3 Press [OK] to modify the time. Use [▲▼] to change the time and use [◀▶] to move left or right.
- 4 Press [OK] to confirm the start time. Playback starts from the selected time on the disc.



For titles recorded without DVD navigation information, such as recorded from broadcast programmes or line input, 'Elapsed time/ Search To Time' function is not available.

Changing TV Channels

If no disc is playing, you can change TV channels using the number [0-9] buttons or [CH+/-] buttons on the remote control or [CH+/-] buttons on the front panel.

External Input selection

If you want to watch through external input such as AV1, AV2, AVF or DV, press the [INPUT] button on the remote control.

You can toggle in the order of AV1 → AV2 → AVF → DV → TV → AV1....

Volume Control

You can control the volume level using [vol+/vol-] button on the remote control.

The DVB-T VCR/DVD Recorder supports 21 levels of volume control (MUTE~20).

DVD Playback

Playing a DVD

- 1 Turn the TV on and select the video input source connected to the DVB-T VCR/DVD Recorder.
Audio system: Turn the audio system on and select the input source connected to the DVB-T VCR/DVD Recorder.
- 2 Press [DVD] to select the DVD mode.
- 3 Press [OPEN/CLOSE] to open the disc tray.
- 4 Load your disc in the tray with the playback side down (label side up).
- 5 Press [OPEN/CLOSE] to close the tray.
- 6 'LOAD' appears on the front panel display, and playback starts automatically. If playback does not start, press [MENU] and select "Play DVD" by using the [▲▼]. Then press [OK]. In some cases, the Disc menu may appear instead.

Playing a DVD

When a DVD+RW or unfinalised DVD+R/-R/-RW is inserted, no title is played automatically but the current TV channel displays on the screen.

If you want to play a title on the DVD+R (+RW), you must press [MENU] to display the Main Menu and select "Play DVD". Then press [OK] to display the disc menu. Select a title to play then press [OK].

If a Disc menu is displayed

- A Disc menu may be displayed when you load a DVD. Use the [◀▶▲▼] buttons to select the title/chapter you want to view, then press [OK] to start playback. Press [TITLE/PBC] or [MENU] to return to the Disc menu.
- The DVB-T VCR/DVD Recorder will not play discs with Region codes different from the DVB-T VCR/DVD Recorder. The Region code for this DVB-T VCR/DVD Recorder is 2 (two).
- Unless stated otherwise, all operations described below use the remote control. Some features may also be available in the Setup menu.
- A disc which is recorded by computer at high speeds (greater than or equal to 2x) may not be recognised.



- A disc which is recorded with unauthorized movie material may not be played.
- A disc which is recorded by another recorder or not recorded correctly may not be recognised or played.

Still Picture and Frame-by-Frame Playback

- 1 Press [PLAY/PAUSE] during playback. The DVB-T VCR/DVD Recorder will go into Still mode.
- 2 You can advance the picture frame-by-frame by pressing [FF (▶▶)] repeatedly during Still mode.

Fast Forward/Backward

- 1 Press [REW (◀◀)] or [FF (▶▶)] during playback. The DVB-T VCR/DVD Recorder will go into Search mode.
- 2 Press [REW] or [FF] to select the desired speed: ▶▶ X2, ▶▶ X4, ▶▶ X8, ▶▶ X16, ▶▶ X32 (forward) or ◀◀ X2, ◀◀ X4, ◀◀ X8, ◀◀ X16, ◀◀ X32 (backward).

Slow Motion

Press [SLOW+] during playback to select the desired speed: 1/2, 1/4, 1/8, PLAY, ...(forward). Press [SLOW-] to go back to normal speed: 1/8 → 1/4 → 1/2 → PLAY.

Changing the Audio Language

Press [AUDIO] and then press [AUDIO] repeatedly during playback to hear a different audio language or audio track.

Subtitles

Press [SUBTITLE] and then press [SUBTITLE] repeatedly during playback to select among all available subtitle languages.

SETUP

PLAYBACK

Zoom

The Zoom function allows you to magnify the video image and scroll around the enlarged image.

- 1** Press [ZOOM] during Play mode to activate the Zoom function.
Each press of the [ZOOM] button changes the Zoom level as follows: X2 → X4 → X1 (normal size)
- 2** Use the [◀▶▲▼] buttons to scroll around the zoomed picture.
- 3** To resume normal playback, press [ZOOM] repeatedly until the X1 (normal picture) appears.



- The Zoom function may not work on some DVDs (ex. Jpg..)

Repeat

- 1** To repeat the currently playing chapter, press [REPEAT]. 'CHAPTER' appears on the TV screen.
- 2** To repeat the currently playing title, press [REPEAT] twice. 'TITLE' appears on the TV screen.
- 3** To repeat the whole disc, press [REPEAT] three times. 'ALL' appears on the TV screen.
- 4** Each press of the [REPEAT] button changes the repeat mode as follows:
[DVD] CHAPTER → TITLE → ALL → SHUFFLE
→ off → CHAPTER ...

A-B

You may repeat a defined period from A to B.

- 1** At the point where you want to start the repeat playback, press [A-B].
- 2** At the point where you want to end the repeat playback, press [A-B] again. Then a defined period from A to B is played back.
- 3** Press [A-B] to exit from repeat playback mode.

Selecting Titles

When a disc has more than one title, you can select among all available titles as follows:

- 1** Press [INFO] twice. Then 'Title' line is already selected. Use [◀▶] to select the desired title number.

Selecting Chapters

When a title on a disc has more than one chapter, you can select among all available chapters as follows:

- 1** Press [PREV (◀◀)] or [NEXT (▶▶)] briefly during playback to select the next or previous chapter.
- 2** To skip directly to any chapter during playback, press [INFO] twice. Use [▲▼] to select the Chapter line. Use [◀▶] to select the desired chapter number.

Disc Menus

Many DVDs contain Disc menus that allow you to access special features. To open a Disc menu, press [MENU]. Then use the [▲▼] buttons to highlight your desired selection and press [OK].

- 1** Press [MENU]. The Disc menu is displayed.
- 2** To exit the Disc menu, press [STOP].

Title Menus

- 1** Press [TITLE/PBC]. If the current title has a menu, the Title menu will appear on the TV screen. Otherwise, the Disc menu may appear.
- 2** The Title menu may contain camera angles, spoken languages and subtitle options, as well as the chapters for the title.

Playing a Picture, Music or DivX files

DivX Playback (DVD, USB)

The DVB-T VCR/DVD Recorder can play DivX files on a disc such as CD-R/RW, DVD+R/RW, DVD-R/RW or on USB Media.

- 1 Prior to playing Divx files on disc or USB device, insert disc and close the tray, or connect the device to USB jack in the front panel of VCR/DVD Recorder.
- 2 Press [MENU] to bring up the Media Browser and select the media (Disc Media, USB Media) you want to play.

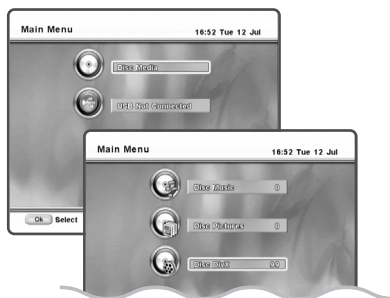

- i** • Media Browser can only appear when you connect a Removable Storage. If not, the Disc Media window appears directly.

- 3 Press [OK] and select the DivX category using [▲▼], then press [OK].

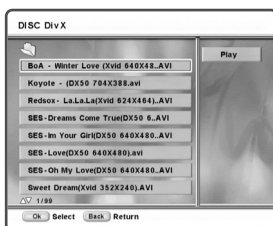

- 4 The DivX Menu appears on the TV screen.

- 5 Use [▲▼] to select a file, then press [OK].

- 6 Press [FF] or [REW] during playback. The VCR/DVD Recorder will go into Search mode.

Press [FF] or [REW] to select the desired speed:

▶▶ X2, ▶▶ X4, ▶▶ X8 (forward) or ◀◀ X2, ◀◀ X4, ◀◀ X8 (backward)

Use [PLAY/PAUSE] to pause playback while the title is playing.

- 7 To stop playback at any time, press [STOP].

Subtitles

Subtitles can be displayed provided they are available on file.

- 1 Move to the Menu of DivX by pressing the [STOP] button.
- 2 Use [▲▼] to select a file of subtitles you want to use.
- 3 Select the file of subtitles by pressing the [OK] button.
- 4 Select the DivX file you want to play and press [OK]. The subtitles can be toggled OFF and ON in the DivX Navigator (press [INFO] twice).

Alternatively you can toggle the subtitles OFF and ON by using the [SUBTITLE] button on the remote control.

- i**
- Playable DivX files are ".avi", ".divx" and playable DivX subtitles are ".smi", ".srt", ".txt", ".sub (Micro DVD, Subviewer)".
 - The file size of the DivX subtitle is limited to 128KB.
 - Playable MPEG 4 SP and ASP is XVID, DivX5.1, DivX5.05, DivX5.02, DivX4.1.2, DivX3.11, and Dr. DivX1.0.2.
 - ASP does not support GMC & Qpel(Quarter Pixel).
 - Playable biterates is to max. 4MBPS.
 - Playable frame number of screens per a second is 30, 25, 24, 12, and 8.
 - Playable resolution is from Min. 200X100 to max. 720X576.
 - Playable audio stream formats are DTS, MPEG I Layer III, MPEG II, PCM and AC-3.
 - It may not be played according to a type of DivX files, a recording method, or a disc state. (The device was authenticated for DivX files from the DivX Networks, Inc. and it is available for playing a normal DivX but may be unavailable for playing the DivX files that have been manufactured with an illegal or abnormal Codec.)
 - DivX, DivX certified and associated logos are trademarks of DivX Networks, Inc. and are used under license.
 - When the image/sound structure of a recorded file have not undergone the interleave, it will output either the image or the sound.

PLAYBACK

Audio CD Playback

The DVB-T VCR/DVD Recorder can play audio CDs on CD-R/RW, DVD+R/RW, DVD-R/RW.

- 1 Insert an Audio CD and close the tray.
- 2 The Main Menu appears on the TV screen. Use [▲▼] to select 'Disc Music', then press [OK].
- 3 The CD Music folder tree appears. Use [▲▼] to select a track or a file, then press [OK].

Playback will stop at the end of the disc.

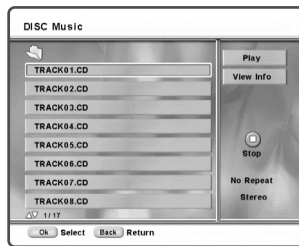

- 4 While playing an Audio CD, use [FF] or [REW] for 2x speed playback.
- 5 Use [PLAY/PAUSE] to pause playback while the disc is playing.
- 6 Press [Repeat] to toggle Repeat Folder, Repeat Track or No Repeat.
- 7 To stop playback at any time, press [STOP].

MP3 Playback (Disc media, USB media)

The DVB-T VCR/DVD Recorder can play MP3 files on a disc such as CD-R/RW, DVD+R/RW, DVD-R/RW or USB memory.

- 1 Prior to playing MP3 files on disc, insert disc and close the tray.
- 2 A MP3 CD is loaded and Disc Media Browser displays. Select Disc Music using [▲▼], then press [OK].
- 3 The MP3 folder tree appears. Use [▲▼] to select a track or a file, then press [OK] or [PLAY].

Playback will stop at the end of the media.

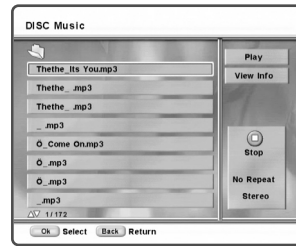

- On the MP3 CD menu, you can display the folders on the disc. Use [▲▼] to select the folder icon on the MP3 CD menu then press [OK]. You can also display just the tracks in the folders. Use [▲▼] to select a folder then press [OK].
- Press [REPEAT] to repeat a track (file) and press again to repeat the whole media.
- If the disc contains JPEG files as well as MP3 files, you can change the Play mode to display JPEG image files by pressing [MENU].

JPEG Playback (Disc media, USB media)

The DVB-T VCR/DVD Recorder can play JPEG Picture files on a disc such as CD-R/RW, DVD+R/RW, DVD-R/RW or USB memory.

- 1 Prior to playing JPEG files on disc, insert disc and close the tray.
- 2 A JPEG CD is loaded and Disc Media Browser displays. Select Picture browser using [▲▼], then press [OK].
- 3 The JPEG folder tree appears. If there are folders which contain JPEG files, select the desired folder using [▲▼] and press [OK].
- 4 You can get the picture through the thumbnail screen.

Playing MP3 Files during a Slide Show

You can enjoy a slide show while listening to MP3 music files.

- 1 Prepare the Disc which includes both MP3 and JPEG files.
- 2 Insert the disc. A disc is loaded and Disc Media screen displays.
- 3 Select the Audio Browser and go to music category.
- 4 During playback of the MP3 files, press [BACK] to return to the Filemedia menu screen. The music playback will not stop.
- 5 Go to Picture category, and select the image files and press [OK] to start the slide show.
- 6 The MP3 files you selected continue to play during the JPEG slide show.

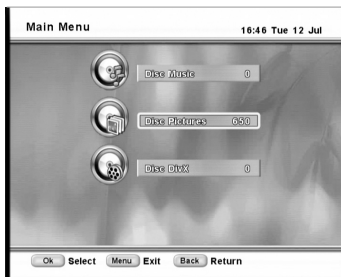

- 5 The full size image will be displayed and a slide show starts automatically with a time interval of 10 seconds.



- 6 Press [NEXT] or [PREV] to manually skip to the next or previous image.
- 7 Press [▶] (or [◀]) to rotate the image (counter) clockwise.

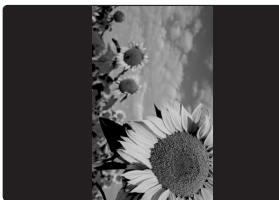

- 8 Press [STOP] to exit the slideshow.



- If the disc contains MP3 files as well as JPEG files, you can change the Play mode to play MP3 files by pressing [MENU].
- When a CD contains both MP3 files and JPEG files, the default Play mode is JPEG image files.
- MP3 files encoded below 32kbps are not supported.



- The DVB-T VCR/DVD Recorder can playback up to 1000 files per disc.
- Press [◀/▶] to move up and down per 8 files in DVD Music Browser, and press [◀◀/▶▶] to move up and down per 6 files in DVD Picture Browser.
- Customers should note that permission is required in order to download MP3 and music from the Internet. Our company has no right to grant such permission. Permission should always be sought from the copyright owner.

PLAYBACK

VCR Playback

Before You Begin

- 1 Press the [VCR] button to set the remote control to operate the VCR deck.
- 2 Turn the TV on and select the video input source connected to the DVB-T VCR/DVD Recorder.

Audio system: Turn the external audio system on and select the input source connected to the DVB-T VCR/DVD Recorder.

Playing a VHS Tape

- 1 Insert a prerecorded video cassette.

If the DVB-T VCR/DVD Recorder is powered off, it will power on automatically.

Make sure the TIMER indicator on the front panel display is not lit. If it is, press [POWER] once.

If a tape without a safety tab is inserted, the DVB-T VCR/DVD Recorder will start playback automatically.



If the DVD Recorder+VCR is powered on by inserting a video cassette with a safety tab, playback will not start automatically.

- 2 Press [PLAY].

It is not necessary to select the tape speed (SP, LP) for playback. It will be automatically selected by the DVB-T VCR/DVD Recorder.

- 3 Press [STOP (■)] to stop playback.

If the tape reaches the end before [STOP] is pressed, the DVB-T VCR/DVD Recorder will automatically stop and rewind.

Tracking Control

Auto Tracking

The automatic tracking function adjusts the picture to remove snow or streaks. It works in the following cases:

- When a tape is played for the first time.
- When the tape speed (SP, LP) changes.
- When streaks or snow appear because of scratches on the tape.

Manual Tracking

If noise appears on the screen during playback, press the [TRACKING +/-] buttons on the remote control and hold until the noise on the screen is reduced.

- If vertical jitter occurs, adjust these controls very carefully.
- Tracking is automatically reset to normal when the tape is ejected or the power cord is unplugged for more than 3 seconds.

Special Playback Features



Notes on special playback features (EG: FFW or FBWD)

Horizontal lines (noise bars) will appear on the TV screen. This is normal.

The audio is automatically muted during special playback modes, so there is no sound during search, slow motion, etc.

During high-speed picture search, a short time is needed to stabilize tape speed when re-entering Play mode. Slight interference may be observed during this time.

Fast Forward/Backward

This function lets you visually search forward and backward for a desired scene on your tape.

1 Press [REW] or [FF] during playback.

Search mode will be activated.

If the DVB-T VCR/DVD Recorder is left in Search mode for more than 3 minutes, the DVB-T VCR/DVD Recorder will automatically resume Play mode to protect the tape and video heads.

2 To return to normal playback, press [PLAY].

Still Picture

1 Press [PLAY/PAUSE] during playback.

A still picture appears on the TV screen.

If a still picture vibrates vertically, stabilize it by using the [TRACKING +/-] buttons on the remote control.

If the DVB-T VCR/DVD Recorder is left in still mode for more than 5 minutes, the DVB-T VCR/DVD Recorder will automatically resume Play mode to protect the tape and video heads.

2 To return to normal playback, press [PLAY].

Slow Motion

1 Press [SLOW+] for Slow Motion playback.

2 Press [SLOW+] and [SLOW-] repeatedly to adjust the Slow Motion playback speed.

Counter Memory Function

This is useful if there is a section of tape you want to view immediately after recording or if you want to return to the same point several times.

1 Begin recording or playing a tape.

2 At the point you want to locate later, reset the realtime counter to 0:00:00 by pressing [CLEAR]. Continue to play or record.

3 Press [STOP] when recording or playback finishes.

4 You can make the tape automatically stop when the counter returns to about '0:00:00' by selecting "Go-to-Zero" function under 'SETUP' -> 'Record/Play Options' -> 'VCR Search'. See page 28.

PLAYBACK

Basic Recording

Recording to TV

Follow the instructions below to record a TV program.

1 Turn on the DVB-T VCR/DVD Recorder and load a recordable disc or tape.

Make sure your TV input is set to view the DVB-T VCR/DVD Recorder.

2 Set the desired Recording mode by pressing [REC MODE] repeatedly.

DVD: HQ (High Quality - 1 hr/disc), SP (Standard Play - 2 hrs/disc), EP (Extended Play - 4 hrs/disc), or SEP (Super Extended Play - 8 hrs/disc). VCR: SP (Standard Play), LP (Long Play - 2 times SP)

3 If your DVB-T VCR/DVD Recorder does not show a TV program, press [INPUT] on the remote control. Use [CH+/-] to select the TV channel you wish to record.

4 Press [REC (●)] once.

Recording will start. The REC indicator lights on the front panel display.

Recording continues until you press [STOP] or the disc is full.

To record for a fixed length of time, see One Touch Record.

5 Press [STOP (■)] to stop recording.



- The maximum number of DVD titles per disc is 49. If the DVB-T VCR/DVD Recorder is powered off.
- If a DVD+RW or unfinalized DVD+R disc is inserted in the tray, no title is played automatically after loading is finished.
- If you are recording to a blank DVD+R (+RW) disc, it may take up to 7 minutes (it depends on disc) for post processing after recording.

One Touch Record (OTR)

One Touch Recording allows you to add recording time in fixed increments at the touch of a button.

1 Follow steps 1-4 under Recording from TV.

2 Press [REC (●)] repeatedly to set the length of the recording.

Recording starts after the first press. Each subsequent press increases the recording time by 15 minutes (DVD) within the available space or 15 minutes (VCR, to a maximum of 10 hours). The recording time is displayed on the front panel display.

Checking the Recording Time

Total time and recorded time are displayed on the TV screen after pressing [INFO].

To Pause the Recording

- 1 Press [PLAY/PAUSE] to pause the disc or tape during recording.
- 2 When you want to continue recording, press [PLAY/PAUSE] or [REC].



Note

- To quit One Touch Recording, press [STOP]. To confirm, press [RED]. To cancel, press [GREEN].
- The DVB-T VCR/DVD Recorder will automatically power off when One Touch Recording ends.



- You cannot record on the VCR deck and DVD deck at the same time.

One Touch Copy - DVD to VHS



- If the DVD you are attempting to copy is copyprotected, you will not be able to copy the disc. It is not permitted to copy Macrovision encoded DVDs.

1 Insert a Disc.

Insert the disc you wish to copy in the DVD deck and close the disc tray.

2 Insert a VHS Tape.

Insert a blank VHS videotape into the VCR deck.

3 Find the place on the DVD disc tape from which you want to start recording using the [PLAY/PAUSE], [FF] and [REW] functions. And press [STOP].

4 Press [VCR <<< DVD] on the front panel.

5 Press [OK] to select the desired Record Mode in 'Copy to Tape' menu:

- SP (Standard Play)
- LP (Long Play, 2 times SP).



6 Press [VCR <<< DVD] again to start copying.

7 Stop the Copy Process

To stop copying at any time, press [STOP]. You must stop the Copy process manually when the DVD movie ends, or the unit may replay and record over and over again.



If you want to start copy any point of disc

1. Find the place on the DVD (or Disc) from which you want to start recording using the [PLAY/PAUSE], [REW] and [FF] functions.
2. Press [COPY] while DVD is in resume stop (>>STOP) mode.
3. Follow the same procedure 5-7.

RECORDING

One Touch Copy - VHS to DVD

You can copy the contents of a VHS tape to a DVD±R or DVD±RW. This allows you to archive your old VHS tapes to DVD.

 If the VHS videotape you are attempting to copy is copy-protected, you will not be able to copy the tape. It is not permitted to copy Macrovision encoded tapes.

1 Insert a VHS Tape.

Insert the VHS videotape you wish to copy into the VCR deck.

2 Insert a DVD±R or DVD±RW disc.

Insert a blank DVD±R or DVD±RW disc in the DVD deck and close the disc tray.

 When using a DVD+RW disc, you must initialize before copying; see page 36.

3 Find the place on the VHS tape from which you want to start recording using the [PLAY/PAUSE], [FF] and [REW] functions. And press [STOP].

4 Press [VCR ►► DVD] on the front panel.

5 Press [ENTER] to select the desired Record Mode in 'Copy to Disc' menu:

- HQ (High Quality - 1 hr/disc)
- SP (Standard Play - 2 hrs/disc)
- EP (Extended Play - 4 hrs/disc)
- SEP (Super Extended Play - 8 hrs/disc)



6 Press [VCR ►► DVD] again to start copying.

7 Stop the Copy Process.

To stop copying at any time, press [STOP]. Copying will stop automatically when the VHS tape ends.

Copy Edit (VCR → DVD)

During one touch copy you can search and resume copy.

1 Press [PLAY/PAUSE] to enter COPY EDIT mode.

2 Press [PLAY/PAUSE] again to playback.

3 Search with [FF/REW] button.

4 Press [VCR ►► DVD] to resume copy.

Timer Recording

Timer Recording using Manual Record Screen

The Timer Recording function allows you to record up to 16 programs within a period of one year.

1 Insert recordable media such as DVD±R, DVD±RW if you want to record to DVD.

2 Press [TIMER].

The 'Timer List' menu appears.



3 Use [▲/▼] to select the timer recording to be modified. Press [OK] to confirm.

The 'Timer Edit' menu appears.

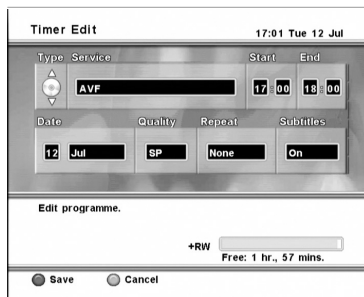

If you did not set the clock on the DVB-T VCR/DVD Recorder, you may have to do so before programming a timer recording.

- Type - Choose DVD or VCR using [▲▼].
- Service – Choose the desired channel, or one of the external inputs from which to record.
- Start (Time) – Set the recording start time.
- End (Time) – Set the recording end time.

- Date – Choose a date up to 1 year in advance.
- Quality – Choose a Record mode.
[DVD] HQ, SP, SEP or EP
[VCR] SP, LP
- Repeat-Choose frequency of the recording.
Daily or Weekly.

4 Enter the necessary information for your Timer Recording(s).

- ◀▶ – Moves the cursor left/right.
- ▲▼ – Changes the setting of the current cursor position.
- Press [TIMER] to exit the Timer Record menu.
- Press [OK] after filling in all the program information.
- Press [TIMER] to display the Timer Record List.

5 Press [OK] or [RED] button to save the program.

The Timer Record List will appear.

6 Press [TIMER] to exit the Timer Record List.

7 Timer indicator will be lit. Timer Recording can be done automatically even if you have put the DVB-T VCR/DVD Recorder into standby mode.



- There is a short delay when a timer recording finishes to confirm the recorded program. If two timer recordings are set to record sequentially (one right after the other), the very beginning of the later program may not be recorded.

RECORDING

■ Cancelling a Timer Recording

You can clear a Timer Recording any time before the recording actually starts.

- Press [TIMER] on the remote control to display the Timer Record List.
- Use [▲▼] to select the program you want to erase on the Timer Recorder List, then press [GREEN] to cancel it.

■ Stopping a Timer Recording in Progress

After a Timer Recording has started, you can still stop the program by pressing [STOP].

- 1 If you press the [STOP] button, the following message will be shown in the screen.



- 2 If you want to stop, press the [RED] button and the timer recording will stop with the OSD below.
If you want to keep recording, press the [GREEN] button.



■ Timer Recording using the EPG application



The EPG application is a feature that simplifies setting the timer. Just select the programme you wish to record in the EPG display. The date, time and channel of that programme are set automatically.

- 1 Insert recordable media such as DVD±R, DVD±RW if you are recording to DVD.
- 2 Press [EPG] to display the EPG.
The 'TV GUIDE' menu appears.
- 3 Press [▲/▼/◀/▶] or enter a channel number by using the number buttons to move around the list.

To know more about the navigation options in the EPG application, see page 22.

- 4 Select a future programme you wish to record.

The description of the programme appears at the bottom of the TV Guide screen.

If 18 is displayed :Indicates that the programme is age limited.



5 Press [RED] to record.

The selected bar becomes red. It means that a timer recording is associated to that programme. Your recorder will automatically begin recording when the programme starts.

6 Press [RED] once more to edit the program.

The Timer Record List will appear.

Timer List			
17:17 Tue 09 Jan			
Program	Channel	Date	Start
Manual Timer	BBC NEWS 24	09 Jan	18:15
Manual Timer	CBBC Channel	09 Jan	20:15
Overlap	BBC NEWS 24	09 Jan	18:16
Manual Timer	AV2	10 Jan	17:16
Manual Timer	BBC NEWS 24	11 Jan	17:16
Manual Timer	BBC THREE	09 Jan	23:17

AV 6/16

Warning. Some programmes overlap

HDD Free: 32 hr., 18 mins.

Edit Delete

7 To modify the timer programme, follow steps 3-7 in 'Timer Recording using Manual Record Screen' of page 49.**■ Cancelling a Timer Recording (EPG)**

You can clear a Timer Recording any time before the recording actually starts.

- Press [TIMER] on the remote control to display the Timer Record List.
- Use [▲▼] to select the program you want to erase on the Timer Recorder List, then press [GREEN] to cancel it.

■ Stopping a Timer Recording in Progress

After a Timer Recording has started, you can still stop the program by pressing [STOP].

For more details, Refer to 'Stopping a Timer Recording in progress' on page 50.



It is not possible to extend the recording duration time of the timer recording set using the EPG application timer setting.

■ Timer Recording Troubleshooting

Even if a Timer Recording is set, the DVB-T VCR/DVD Recorder will not record if:

- No disc is loaded in the DVD tray when in record to DVD mode.
- A non-recordable disc is loaded.
- 'Lock Disc' is set to YES in the DISC Operation menu; see page 56.
- There are already 49 titles recorded on the disc.

You cannot enter a Timer Recording if:

- A recording or playing titles is already under way.
- The start time has already passed.
- 16 Timer Recordings have already been set.

If two or more Timer Recordings overlap:

- The earlier program takes priority.
- When the earlier program finishes, the later program starts.
- If two programs are set to start at exactly the same time, the program entered first takes priority.

Confirmation is not possible when:

- The 'Lock Disc' setting is set to YES.
- There are already 49 titles recorded on the disc.

If the disc is damaged, the recording may not complete successfully, even if the Check field shows 'Rec. OK'.

**Recording Priority**

- *Timer Recording and OTR (One Touch Record) have the same priority but they have lower priority than manual recording. During manual recording, Timer Recording or OTR will be ignored.*

Recording from an External Input

Recording from External Components

You can record from an external component, such as a camcorder, VCR or Digital Camera, connected to any of the DVB-T VCR/DVD Recorder's external inputs.

- 1 Make sure the component you want to record from is connected properly to the DVB-T VCR/DVD Recorder; see pages 17~20.**
- 2 Use [CH+/-] or [INPUT] to select the external input to record from.**
- 3 Load a recordable disc or tape.**
When you load a new, blank recordable disc (DVD±RW, DVD±R), the recorder will take a moment to initialize it for recording.
- 4 Set the desired Recording mode by pressing [REC MODE] repeatedly.**
Available disc space will be displayed by selecting recording mode. For further details refer to pages 28.
- 5 Press [REC (●)] once.**
Recording will start. The REC indicator lights on the front display panel.
Recording continues until you press [STOP] or the disc is full.
To record for a fixed length of time, see 'One Touch Record' on page 47.
- 6 Press [STOP (■)] to stop recording.**



- If your source is copy-protected, you will not be able to record it using the DVB-T VCR/DVD Recorder. See 'Copyright Notice' on page 9 for more details.

Recording from a Digital Camcorder

You can record from a digital camcorder connected to the DV IN jack on the front panel of the DVB-T VCR/DVD Recorder.

- 1 Make sure your digital camcorder is connected to the front panel DV IN jack; see page 20.**
- 2 Press [INPUT] to select the DV input.**
DV Input screen appears. Then, if you select 'Yes', it will be changed to DV input.
- 3 Find the place on the camcorder tape from which you want to start recording.**
For best results, pause playback at the point you want to start recording.
- 4 Press [REC] once to start recording.**
Recording is automatically paused if the DVB-T VCR/DVD Recorder detects no signal. You can pause or stop the recording by pressing [PLAY/PAUSE] or [STOP].

Disc Playback and Editing

This section explains edit functions for the entire disc and for the titles in the disc.

This recorder offers various edit options for various disc types. Before you edit, check the disc type and select the option available for your disc.

i You may lose the edited contents if you remove the disc or a timer recording starts while editing.

- 1 Press [MENU] to go to 'Main Menu' menu.
- 2 Select the 'Disc Playlist' using [▲▼] and press [OK] then 'Disc Playlist' screen appears.

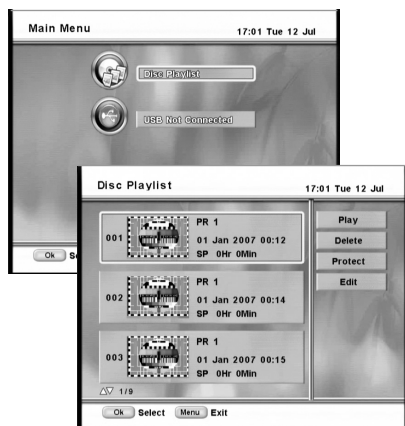

Playing a DVD title

- 3 Use [▲▼] to select the desired title you wish to play.
- 4 Press [OK] twice to play it.
- 5 To exit playback mode, press [MENU].

Deleting a DVD title

Follow these instructions to delete a title from the Title List.

- 3 Select the title to be erased using [▲▼] and press [OK].
- 4 Then select 'Delete' using [▲▼].
- 5 Press [OK] to erase the title.
- 6 Select 'Delete Title' and press [OK].
- 7 Select 'Yes' and press [OK] to confirm.

RECORDING

EDITING

Protecting a DVD title

If you want to protect a title from accidental recording, editing, or erasing, you can protect the title. Later, if you change your mind, you can unprotect the title.

- 1 Select the title to be protect using [**◀▶▶▶▼**] and press [OK].
- 2 Then select 'Protect' using [**▲▼**] on the left side menu.

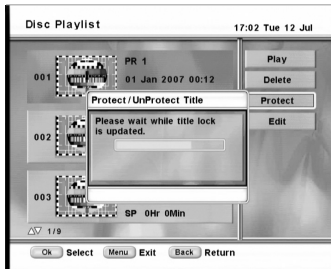

- 3 Press [OK] to protect the title.
- 4 The protect icon will appear on the thumbnail of the title.

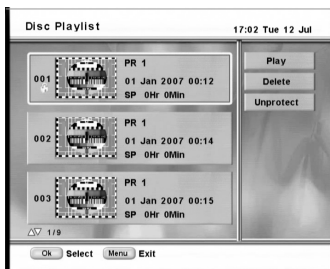

- 5 To 'Unprotect' the title, select 'Unprotect' in step 5.

Editing a DVD title

Renaming (Labeling) a Title

Follow these instructions to rename a title list name, i.e., to edit the title of a recorded program.

- 1 Press [MENU] to go to 'Main Menu' menu.
- 2 Select the 'Disc Playlist' using [**▲▼**] and press [OK] then 'Disc Playlist' screen appears.
- 3 Select the title to be labeled using [**▲▼**] and press [OK].
- 4 Select 'Edit' using [**▲▼**].
- 5 Press [OK] to go to submenu.
- 6 Select 'Name' using [**▲▼**].
- 7 Press [OK] to change the title name.
- 8 The Keyboard Menu will be displayed. Use [**◀▶▶▶▼**] to select a character or function and press [OK].
 - CLEAR: Clear all
 - BACK: Clears the last character
- 9 After the new title name is complete, select 'SAVE' and press [OK].

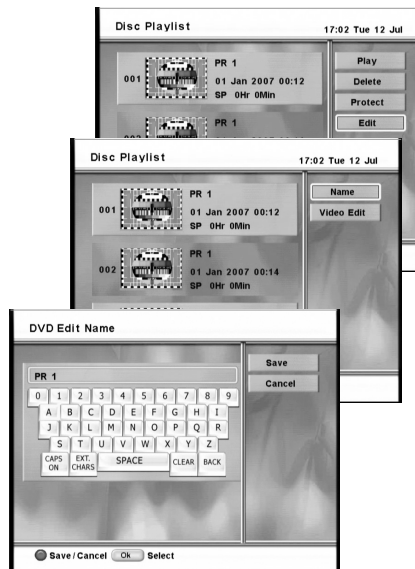

Editing a Title

When you insert a DVD±R or DVD±RW disc already recorded by your VCR/DVD Recorder, you can edit the titles and chapters in a variety of ways.

- 1 Press [MENU] to go to 'Main Menu' menu.
- 2 Select the 'Disc Playlist' using [▲▼] and press [OK] then 'Disc Playlist' screen appears.
- 3 Select the title to be edited using [▲▼] and press [OK].
- 4 Select 'Edit' using [▲▼].
- 5 Press [OK] to go to submenu.
- 6 Select 'Video Edit' using [▲▼].
- 7 Press [OK] to go to DVD Edit menu.
- 8 The DVD Edit Menu will be displayed.

• Title and Chapter:

When you insert a DVD±R or DVD±RW disc already recorded by your VCR/DVD Recorder, all recorded titles on the disc appear on your screen. If a selected title has chapters, you can skip to the next or previous chapter by pressing [NEXT] or [PREV]. You can also see how many chapters are in a title by pressing [INFO] during playback.

- Use [▲/▼] to select 'Title' or 'Chapter'.
- Use [◀/▶] to select the desired chapter number.

• Edit Thumbnail :

Creates a new Thumbnail at the point in the title where [OK] is pressed.

• Split Title :

Use to divide the title into two separate titles. Press [OK] at the point where you want to divide the title into two separate titles.



- Split Title may take several minutes.
- After editing is complete, a DVD-RW, DVD±R disc will not be compatible with other DVD players until you make the disc compatible; see page 58.

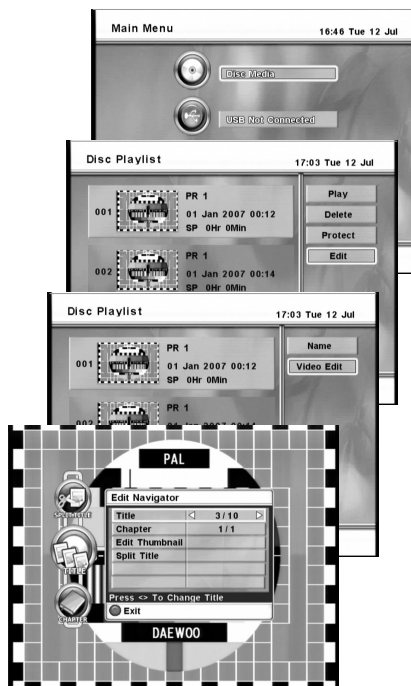

Disc Media Operation

Usage of DISC OP button for Disc Media Operation

For recordable DVD media, such as DVD±R and DVD±RW discs, you can manage the disc using the Disc Operation.

The DVD±R DISC OP menu allows you to rename your disc or finalise it so it will be compatible with most other DVD players.

The DVD±RW DISC OP menu allows you to erase, lock, or unlock your disc. You can also make it compatible with most other DVD players.

Disc Information

- 1 Press [DISC OP] to go to 'Disc Operation' mode.
- 2 The 'Disc Information' screen shows you disc information, such as disc type, number of recording, free space, locked and compatible.

Disc Operation

Disc Type	+RW
Num Recordings	16
Free Space	41%
Locked	No
Compatible	Yes

Press <> To Choose Disc Operation.

Erase the disc (DVD±RW)

- 1 Press [DISC OP] to go to 'Disc Operation' mode.
- 2 Use [◀/▶] to select 'Erase Disc' menu. Then press [▲] or [▼].
- 3 If you want to erase the whole disc, select 'Yes' by using [◀/▶]. To confirm, select 'Yes'. To cancel, select 'No'. If you select 'Yes' and press [OK], all the contents of the disc will be lost.

Disc Operation

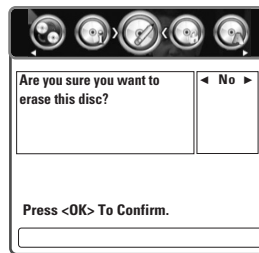

DVD±R discs cannot be locked (unlocked) or erased.

Lock/Unlock the disc (DVD±RW)

If you want to protect a disc from accidental recording, editing, or erasing, you can lock the disc. Later, if you change your mind, you can unlock the disc.

- 1 Press [DISC OP] to go to 'Disc Operation' mode.
- 2 Use [◀/▶] to select 'Lock/Unlock Disc' menu. Then press [▲] or [▼].
- 3 You can see the current disc status (Locked or Unlocked).

Disc Operation

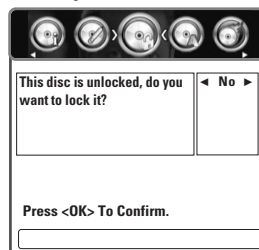

- 4 You can change the disc status by selecting 'Yes' by using [◀/▶] and press [OK]. The 'Changing Disc Status' bar will appear. This process takes a few seconds.
- 5 After the process is finished, the recorder goes to the 'Information' menu automatically.

Edit Disc Name

You can rename your disc to any name you choose. The default disc name is 'MY DVD'.

- 1 Press [DISC OP] to go to 'Disc Operation' mode.
- 2 Use [◀/▶] to select 'Edit Disc Name' menu. Then press [▲] or [▼].
- 3 If you want to change the disc name, select 'Yes' by using [◀/▶] and pressing [OK].



- 4 The Keyboard Menu appears.
- 5 Use [◀▶▲▼] to select and press [OK] to enter the name of the disc.
 - **On the remote control**
 - ◀, ▶, ▲, ▼: Moves the cursor to the desired position.
 - OK: enter the name
 - **On the typing screen**
 - CLEAR: Clear all
 - BACK: Clears the last character.
- 6 Press [RED] to save.



If 'Lock Disc' is set to 'Yes' in the DISC Operation menu, you cannot rename your disc; see page 56.

Finalise Disc (DVD-RW, DVD±R)

Finalising a DVD±R (or DVD-RW) 'locks' its recordings permanently so the disc can be played on most standard DVD players or computers equipped with DVD-ROM drives.

- 1 Press [DISC OP] to go to 'Disc Operation' mode.
- 2 Use [◀/▶] to select 'Finalise Disc' menu for a DVD±R (or DVD-RW). Then press [▲] or [▼].
- 3 Use [◀/▶] to select 'Yes'. Press [OK] to make the disc compatible.
- 4 After the process is finished, the recorder goes to the 'Information' menu automatically.

Disc Operation

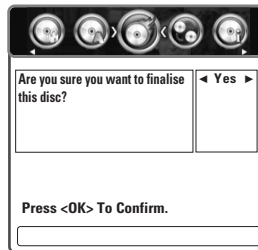

- Once you have finalised a DVD±R (or DVD-RW) disc, you cannot edit or record anything else on that disc.
- It may take over 7 minutes for finalising the edited disc, you must wait till the set finishes the finalising operation.

Make Compatible

'Make Compatible' for a DVD+RW will automatically create a menu screen for navigating the disc. This function is accessible by pressing [DISC OP].

- 1 Press [DISC OP] to go to 'Disc Operation' mode.
- 2 Use [◀/▶] to select 'Make Compatible' menu for a DVD+RW. Then press [▲] or [▼].
- 3 Use [◀/▶] to select 'Yes' and press [OK] to make the disc compatible.
- 4 After the process is finished, the recorder goes to the 'Information' menu automatically.

Disc Operation

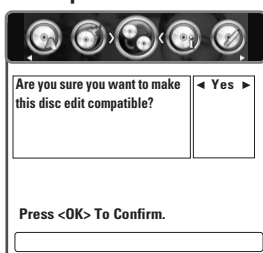

- 'Make Compatible' can take up to 3-4 minutes depending on the type of disc, how much is recorded on the disc, and the number of titles on the disc.
- If you do not make your DVD+RW disc compatible, your edits may not be recognized by other DVD players.
- Some DVD+RW discs may be manufactured as edit compatible. In this case, you will see a message saying 'Disc already edit compatible. It should play on your DVD player'.

Troubleshooting

Check the following guide for the possible cause of a problem before contacting customer support.

Symptom	Cause	Solution
No power.	The power cord is disconnected.	Plug the power cord into the wall outlet securely.
No picture.	The TV is not set to receive DVB-T VCR/DVD Recorder signal output.	Select the appropriate video input on the TV so the picture from the DVB-T VCR/DVD Recorder appears on the TV screen.
	The video cable is not connected securely.	Connect the video cable securely.
	The TV power is turned off.	Turn on the TV.
No sound.	The equipment connected with the audio cable is not set to receive DVB-T VCR/DVD Recorder signal output.	Select the correct input mode on the audio receiver so you can listen to the sound from the DVB-T VCR/DVD Recorder.
	The audio cables are not connected securely.	Connect the audio cables securely.
	The power on the equipment connected with the audio cable is turned off.	Turn on the equipment connected with the audio cable.
	The audio cables are damaged.	Replace with new ones.
Playback picture is poor. DVB-T VCR/DVD Recorder does not start playback.	The disc is dirty.	Clean the disc.
	No disc is inserted.	Insert a disc. (Check that the disc indicator on the front panel display is lit.)
	An unplayable disc is inserted.	Insert a playable disc. (Check the disc type, colour system, and regional code.)
	The disc is placed upside down.	Place the disc with the playback side down.
	The disc is not placed within the guide.	Place the disc on the disc tray correctly inside the guide.
	The disc is dirty.	Clean the disc.
	The Parental Control level is set.	Cancel the Parental Control function or change the rating level.
	Picture from external input is distorted.	The video signal from the external component is copy-protected.
Some channels are skipped over when using [CH+/-].	The skipped channels were deleted with the 'Adjust Channels' feature.	Use the 'Adjust Channels' feature to restore channels.
Picture or sound of broadcasting channel is weak or missing.	Antenna or cables are loose.	Tighten connections or replace cable.
Camcorder image not shown.	Wrong Tuning Band is selected in the DVB-T VCR/DVD Recorder Setup menu.	Try all 'Auto Tune' options; see page 25 for details.
	Camcorder is off.	Turn camcorder on and operate properly.
Camcorder image via A/V input to DVB-T VCR/DVD Recorder is not shown on TV screen.	The DVB-T VCR/DVD Recorder's source is not set to AV, AVF, or DV.	Use [INPUT] to select AV input channel (AV, AVF, or DV).
Can't play disc recorded on this DVB-T VCR/DVD Recorder on another DVD player.	The disc was not finalised (or not made compatible if using a DVD+RW).	Finalise the disc; see page 57.
	Some players will not play even a finalised disc.	No solution.
	Discs recorded with copy-once material cannot be played on other players.	No solution.

EDITING

Symptom	Cause	Solution
Cannot record or did not record successfully.	The remaining blank space on the disc is insufficient.	Use another disc.
	The source you are trying to record is copy-protected.	You cannot record the source.
	When setting the recording channel, the channel is tuned on your TV's tuner.	Select the channel on the DVB-T VCR/DVD Recorder's built-in TV tuner.
Timer Recording not possible.	Clock in DVB-T VCR/DVD Recorder is not set to correct time.	Set clock to correct time. See 'Set Clock' on page 27.
	Timer has been programmed incorrectly.	Reprogram Timer. See 'Timer Recording' on page 49-51.
	TIMER indicator light does not appear after programming timer.	Reprogram Timer.
Stereo Audio Record and/or Playback not present.	TV is not Stereo-compatible.	No solution.
	Broadcast program is not in stereo format.	No solution.
	DVB-T VCR/DVD Recorder A/V Out jacks are not connected to TV A/V In jacks.	Make A/V connections. Stereo is available only via A/V output from DVB-T VCR/DVD Recorder.
	DVB-T VCR/DVD Recorder Audio/Video Out is not selected for viewing at the TV.	Select AUX or A/V source as TV input.
Remote control does not work properly.	The remote control is not pointed at the remote sensor of the DVB-T VCR/DVD Recorder.	Point the remote control at the remote sensor of the DVB-T VCR/DVD Recorder.
	The remote control is too far from the DVB-T VCR/DVD Recorder.	Operate the remote control within 23 ft (7m).
	There is an obstacle in the path of the remote control and the DVB-T VCR/DVD Recorder.	Remove the obstacle.
	The batteries in the remote control are dead.	Replace the batteries.



RESET : If the set is in malfunctions, unplug the power cord, and then plug it in after 5 seconds. As this set is a Digital Multimedia Product, malfunction may occur.

Moisture Condensation

Moisture condensation can occur:

When the DVB-T VCR/DVD Recorder is moved from a cold place to a warm place.

In locations where moisture condensation may occur:

Keep the DVB-T VCR/DVD Recorder plugged into an AC power outlet with the power on. This will help prevent condensation.

Under extremely humid conditions.

When condensation has occurred, wait a few hours for the DVB-T VCR/DVD Recorder to dry before using it.

Technical Specifications

General

Power requirements	220–240V~, 50/60 Hz
Power consumption	Operation: Maximum 29W Standby: 4.9W
Dimensions(approx.)	430 x 92 x 312 mm (w x h x d)
Mass (approx.)	Net : 4.3kg Gross : 5.6kg
Operating temperature	41°F to 95°F (5°C to 35°C)
Operating humidity	5% to 90%
Signal system	PAL Colour

Recording

Recording formats	DVD Video Recording, DVD-VIDEO
Recordable discs	DVD±R, DVD±RW
Recordable time	[DVD] (Approx.) 1 hour (HQ mode), 2 hours (SP mode), 4 hours (EP mode), 8 hours (SEP mode)

Video recording format

Sampling frequency	27MHz
Compression format	MPEG 2

Audio recording format

Sampling frequency	48kHz
Compression format	MPEG1 Layer2

VCR Specifications

Head system	4 Head Video, 2 Head Hi-Fi helical scan azimuth system
Timer	24-hour display type
Tape speed	SP: 23.39 mm/sec LP: 11.70 mm/sec
Tape width	12.7mm
Rewind time	less than 150 sec (E-180)
Frequency range	20Hz to 20 KHz
Signal-to noise ratio	43 dB
Dynamic range	75 dB
Channel separation	45 dB

DVD Specifications

Frequency response	DVD (PCM 48 kHz): 8 Hz to 22 kHz, CD: 8 Hz to 20 kHz
Video S/N	More than 60 dB
Audio S/N	More than 90 dB
Harmonic distortion	Less than 0.04%
Dynamic range	More than 90 dB
Resolution	Over 500 lines (HQ Recording)

Inputs

Antenna In/Out	U/V-mixed; 75 Ω unbalanced
Video In	1.0 Vp-p, unbalanced
Audio In	-8.8 dBm
DV IN	4pin (i.LINK/IEEE 1394 standard)
USB IN	Series 'A' Connector (USB 2.0 Full Speed)

Outputs

Video output	Video output terminal, 1.0 Vp-p, unbalanced, RGB output (75Ω in load, R : 0.7Vp-p, G : 0.7Vp-p, B : 0.7Vp-p)
Audio output	Audio output terminal (2 kinds), 2Wrms (DVD) Analog audio output : 2.0Wrms, Digital audio output : coaxial
S-Video output	1.0Vp-p, 75Ω unbalanced, Mini DIN 4-pin x 1, C : 0.286Vp-p, 75Ω
Component Video output/Progressive Scan	(Y) 1.0Vp-p, 75 Ohm, negative sync, RCA jack X 1, (Pb)/(Pr) 0.7Vp-p, 75 ohm , RCA jack X2
HDMI output	19pin (HDMI standard) Type

Accessories

RF cable/ Remote control/ 2 Batteries/ HDMI cable

Design and specifications are subject to change without notice.

Manufactured under license from Dolby Laboratories. 'Dolby' and the double-D symbol are trademarks of Dolby Laboratories. DTS and DTS Digital Out are registered trademarks of Digital Theater Systems, Inc.

REFERENCE

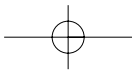
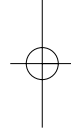
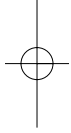
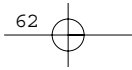

DAEWOO

GUARANTEE REGISTRATION

REGISTERING YOUR NEW DAEWOO PRODUCT

To register your product for its 12 month guarantee please complete and return the section below.

MR _____
 MRS _____
 MS _____
 SURNAME _____ INITIALS _____
 NUMBER/HOUSE NAME/STREET _____
 TOWN _____
 COUNTRY _____ POSTCODE _____

PRODUCT DETAILS

MODEL No. _____
 SERIAL No. _____
 DATE OF PURCHASE _____
 PRODUCT DESCRIPTION _____
 PRODUCT VALUE _____
 NAME OF RETAILER _____

On the expiry date of the manufacturer's guarantee you will be sent details of our annual insurance plan but if you have already bought an extended warranty for this product from your retailer please tick box

The information provided will be held on computer by the DAEWOO Registration Department of Domestic & General Insurance Co. Limited for the provision of warranty insurance or product related purposes. The information is to be disclosed to third parties, should you prefer not to receive product related details write to Domestic & General Insurance Co. Limited, on the address overleaf.

DAE REG / 295

IMPORTANT

**YOUR 1ST YEAR
MANUFACTURER'S
GUARANTEE**

Please keep this with your purchase receipt, which will be required if service is needed on this product during the guarantee period.

KEEP THIS SECTION FOR FUTURE REFERENCE

MODEL No. _____
 SERIAL No. _____
 DATE OF PURCHASE _____

DAEWOO

**TEAR
OFF HERE
AND RETURN
TODAY**

DAEWOO GUARANTEE CONDITIONS

This product is guaranteed for 12 months from the date of original purchase. Any defect that arises due to faulty materials or workmanship will be repaired free of charge during this period by the dealer from whom you purchased the unit. The guarantee is subject to the following provisions.

The guarantee does not cover accidental damage, misuse, cabinet parts, knobs or consumable items such as batteries, drive belts or bulbs.

The product must be correctly installed and operated in accordance with the instructions contained in the manual. It must be used solely for domestic purposes. For further information regarding your guarantee please see the section at the rear of your user manual.

The guarantee will be rendered invalid if the product is resold or has been damaged by inept repair.

DAEWOO disclaims any liability for incidental or consequential damages.

The guarantee is in addition to and does not diminish your statutory or legal rights.

In the event of a breakdown please refer to your instruction manual and check all plugs, fuses and electricity supply. In the event of there being no breakdown you will be charged for the repair.

DAEWOO GUARANTEE DEPARTMENT

Leicester House
17, Leicester Street
Bedworth
Nuneaton
Warwickshire CV12 8JP

Free Manuals Download Website

<http://myh66.com>

<http://usermanuals.us>

<http://www.somanuals.com>

<http://www.4manuals.cc>

<http://www.manual-lib.com>

<http://www.404manual.com>

<http://www.luxmanual.com>

<http://aubethermostatmanual.com>

Golf course search by state

<http://golfingnear.com>

Email search by domain

<http://emailbydomain.com>

Auto manuals search

<http://auto.somanuals.com>

TV manuals search

<http://tv.somanuals.com>