

# **LCD TELEVISION INSTRUCTION MANUAL**

**DLT-26C2**

**DLT-26C3**



**DLT-32C1**

**DLT-32C2**

**DLT-32C3**

**DLT-37C3**

# Caution

	<b>CAUTION</b> RISK OF ELECTRIC SHOCK DO NOT OPEN	
CAUTION : TO REDUCE THE RISK OF ELECTRIC SHOCK, DO NOT REMOVE COVER (OR BACK). NO USER-SERVICEABLE PARTS INSIDE. REFER SERVICING TO QUALIFIED SERVICE PERSONNEL.		



The lightning flash with arrowhead symbol, within an equilateral triangle, is intended to alert the user to the presence of uninsulated "dangerous voltage" within the product's enclosure that may be of sufficient magnitude to constitute a risk electric shock.



The exclamation point within an equilateral triangle is intended to alert the user to the presence of important operating and servicing instructions in the literature accompanying the appliance.

**WARNING:** TO REDUCE THE RISK OF FIRE OR ELECTRIC SHOCK HAZARD, DO NOT EXPOSE THIS APPLIANCE TO RAIN OR MOISTURE.

**CAUTION :** TO PREVENT ELECTRIC SHOCK, MATCH WIDE BLADE OF PLUG TO WIDE SLOT, FULLY INSERT.

## **DISPOSAL OF USED ELECTRICAL & ELECTRONIC EQUIPMENT (Europe only)**



The meaning of the symbol on the product, its accessory or packaging indicates that this product shall not be treated as household waste. Please, dispose of this equipment at your applicable collection point for the recycling of electrical & electronic equipments waste. In the European Union and Other European countries which there are separate collection systems for used electrical and electronic product. By ensuring the correct disposal of this product, you will help prevent potentially hazardous to the environment and to human health, which could otherwise be caused by unsuitable waste handling of this product. The recycling of materials will help conserve natural resources. Please do not therefore dispose of your old electrical and electronic equipment with your household waste. For more detailed information about recycling of this product, please contact your local city office, your household waste disposal service or the shop where you purchased the product.

# Important Safeguards

Please read the following safeguards for your TV and retain for future reference. Always follow all warnings and instructions marked on the television.

## 1. Read, Retain and Follow All Instructions

Read all safety and operating instructions before operating the TV. Retain them safely for future reference. Follow all operations and instructions accordingly.

## 2. Heed Warnings

Adhere to all warnings on the appliance and in the operating instructions.

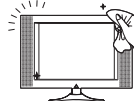

## 3. Cleaning

Unplug the TV from the wall outlet before cleaning. Do not use liquid, abrasive, or aerosol cleaners. Cleaners can permanently damage the cabinet and screen. Use a lightly dampened cloth for cleaning.

## 4. Attachments and Equipment

Never add any attachment and/or equipment without approval of the manufacturer as such additions may result in the risk of fire, electric shock or other personal injury.



## 5. Water and Moisture

The apparatus shall not be exposed to dripping or splashing and that no objects filled with liquids, such as vases, shall be placed on the apparatus.



## 6. Setting

Do not place this TV on an unstable cart, stand or table. Placing the TV on an unstable base can cause the TV to fall, resulting in serious personal injuries as well as damage to the TV. Use only a cart, stand, bracket or table recommended by the manufacturer or salesperson.

## 7. Ventilation

Slots and openings in the cabinet are provided for ventilation and to ensure reliable operation of the TV and to protect it from overheating. Do not cover the ventilations openings in the cabinet and never place the set in a confined space such as built-in cabinet unless proper ventilation is provided. Leave a minimum 10 cm gap all around the unit.

## 8. Power Source

This TV should be operated only from the type of power source indicated on the marking label. If you are not sure of the type of power supplied to your home, consult your appliance dealer or local power company.

## 9. Grounding or Polarization

This TV is equipped with a polarized alternating current line plug (a plug having one blade wider than the other). This plug will fit into the power outlet only one way. This is a safety feature. If you are unable to insert the plug fully into the outlet, try reversing the plug. If the plug should still fail to fit, contact your electrician to replace your obsolete outlet. Do not defeat the safety purpose of the polarized plug. A warning that an apparatus with CLASS I construction shall be connected to a MAINS socket outlet with a protective earthing connection.

## 10. Power-Cord Protection

Power-supply cords should be routed so that they are not likely to be walked on or pinched by items placed upon or against them, paying particular attention to cords at plugs, wall outlets, and the point where they exit from the TV. MAINS plug is used as the disconnect device, the disconnect device shall remain readily operable.

## 11. Lightning

For added protection for this TV during a lightning storm, or when it is left unattended and unused for long periods of time, unplug it from the wall outlet and disconnect the antenna or cable system. This will prevent damage to the TV due to lightning and power-line surges.



## 12. Wall or Ceiling Mounting

When mounting the product on a wall or ceiling, be sure to install the product using the designated mounting tool according to the method recommended by the manufacturer.

# Important Safeguards

## 13. Power Lines

An outside antenna system should not be located in the vicinity of overhead power lines or other electric light or power circuits, or where it can fall into such power lines or circuits. When installing an outside antenna system, extreme care should be taken to keep from touching such power lines or circuits as contact with them might be fatal.

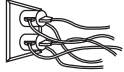

## 14. Overloading

Do not overload wall outlets and extension cords as this can result in a risk of fire or electric shock.

## 15. Object and Liquid Entry

Never push objects of any kind into this TV through openings as they may touch dangerous voltage points or short-out parts that could result in fire or electric shock. Never spill liquid of any kind on or into the TV.

## 16. Outdoor Antenna Grounding

If an outside antenna or cable system is connected to the TV, be sure the antenna or cable system is grounded so as to provide some protection against voltage surges and built-up static charges. Section 810 of the National Electric Code, ANSI /NFPA No. 70-1984, provides information with respect to proper grounding of the mast and supporting structure, grounding of the lead in wire to an antenna discharge unit, size of grounding conductors, location of antenna discharge unit, connection to grounding electrodes, and requirements for the grounding electrode.

EXAMPLE OF ANTENNA GROUNDING

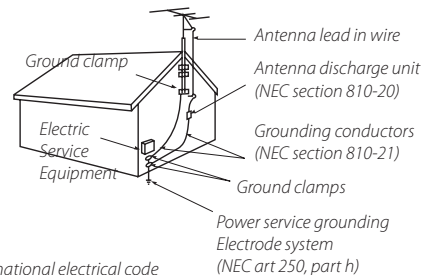

NEC — national electrical code

## 17. Servicing

Do not attempt to service this TV yourself as opening or removing covers may expose you to dangerous voltage or other hazards. Refer all servicing to qualified service personnel.

## 18. Damage Requiring Service

Unplug the TV from the wall outlet and refer servicing to qualified service personnel under the following conditions:

- When the power-supply cord or plug is damaged.
- If liquid has been spilled, or objects have fallen into the TV.
- If the TV has been exposed to rain or water.
- If the TV does not operate normally by following the operating instructions. Adjust only those controls that are covered by the operating instructions as an improper adjustment of other controls may result in damage and will often require extensive work by a qualified technician to restore the TV to its normal operation.
- If the TV has been dropped or the cabinet has been damaged.
- When the TV exhibits a distinct change in performance - this indicates a need for service.

## 19. Replacement Parts

When replacement parts are required, be sure the service technician has used replacement parts specified by the manufacturer or have the same characteristics as the original part. Unauthorized substitutions may result in fire, electric shock or other hazards.

## 20. Safety Check

Upon completion of any service or repair to the TV, ask the service technician to perform safety checks to determine that the TV is in safe operating condition.



## 21. Heat

The product should be situated away from heat sources such as radiators, heat registers, stoves, or other products (including amplifiers) that produce heat.

# Warning

**This section must be read carefully and followed by the user prior to the operation of the product.**

The manual states important instructions for the user's own safety, and the proper operation of the product.



## WARNING

**Ignoring or disregarding the contents of this section and improper operation of the product may result in the person's death or serious injury.**

In case of an accident, please unplug the unit from the outlet immediately.

To reduce the risk of electric shock, do not remove cover or back. No user-serviceable parts inside. Refer to qualified service personnel for repair.



Do not put any object that contains water - such as flowerpot - near to the unit. The water may penetrate into the unit, and be a cause of fire or hazardous electric shock.



To prevent fire and damages to the product, unplug the unit from the outlet during lightning storm, or when it is left unattended and unused for a long period of time.

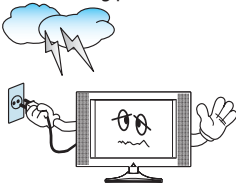

Do not put on or use the product near water and moisture - such as in a bathroom, washbowl, etc. It may be a cause of fire and electric shock hazards.



Slots and openings in the case are provided for ventilation to ensure reliable operation of the product. Never put in any item - such as a coin, paper, match - through these openings since it may touch dangerous voltage points that could result in fire or shock hazard.



Do not let children hang on or climb on the product since it may be a cause of serious injury.



Hold the plug when unplugging the unit from the outlet. The cord may cause fire or electric shock if damaged.



Do not cause the product to lean or put it in an unstable place since it may cause a serious injury to a person, as well as damage to the product if it falls.



# Warning

**This section must be read carefully and followed by the user prior to the operation of the product.**  
The manual states important instructions for the user's own safety, and the proper operation of the product.



## CAUTION

**Ignoring or disregarding the contents of this section and improper operation of the product may result in the person's death or serious injury.**

Please keep the user's manual in a safe place for future reference.

Do not put volatile substance such as benzene, naphtha- near the product since it may cause a change in the product's colour.

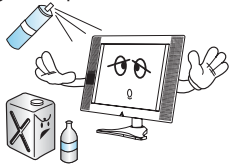

Do not spill water or drop the remote controller since it may be a cause of malfunctioning.



Do not view the TV too closely since it may cause damage in your eyesight.

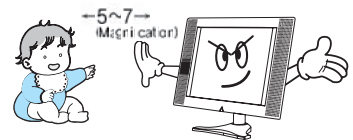

Refer servicing to qualified service personnel for cleaning at least once a year since dust inside the TV set may be a result of fire and malfunctioning of the product.



Do not cover the top of the television set. Ventilation will be prevented, and it may be a cause of fire if the product is internally overheated.

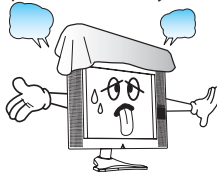

The product should be situated away from any heat source such as radiators, heat registers, stoves, or other products that produce heat.

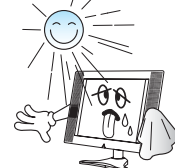

Do not put on any heavy item on the power cord since it may result in fire or hazardous electric shock if the cord is damaged.



Please be advised of electric wires and cables when installing the antenna. It may be a cause of hazardous electric shock and fire if the antenna touches or falls on the electric wire; thus, it must be installed firmly, and far away from the cables.



Unplug the power from the outlet and all the related connections from the unit to prevent electric shock. At least two people must work together to move the TV set when transporting to prevent the TV from falling, and consequently, any serious injury or damage.

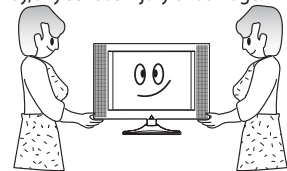

Do not touch the power cord with moisturized or wet hands when plugging to or unplugging from the outlet since it may be a cause of electric shock.



Do not expose the product to a dusty or moisturized place since it may be a cause of malfunctioning.

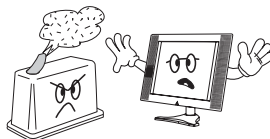

The screen case of the product (32C1) is scratched easily. When cleaning, use the microfiber sheet which is enclosed. When a force to give it cleans strongly, it will be scratched and the product's colour will be changed. If the foreign material gets in the fiber, the product will be scratched. Shake off the fiber cleanly and use.



# Table of Contents

## **Installation and Maintenance**

Antenna Connection . . . . .	10
Video Connection . . . . .	13
Camcorder & Video Game Connection . . . . .	14
DVD player/STB(Set Top Box) Connection . . . . .	15
PC Connection . . . . .	17
Cable TV Broadcasting Connection . . . . .	19
Connect with the Dolby Digital AMP . . . . .	20
Name of Each Part . . . . .	21

## **Basic Guide**

Parts of the Remote Controller . . . . .	24
Method To Use Basic Menu . . . . .	26
To Watch TV . . . . .	27
Setting Up TV Stations . . . . .	29
Selection of AV and Multimedia Input Signal . . . . .	33

## **Application Guide**

Screen Adjustment . . . . .	35
Sound Adjustment . . . . .	40
Utilities . . . . .	43
Teletext . . . . .	45

## **DVB-T Guide**

Channel Banner . . . . .	46
Setting up DVB-T System . . . . .	48
Electronic Program Guide(EPG) . . . . .	52
Common Interface Module Menu . . . . .	54
Digital Teletext (MHEG5) . . . . .	56
User Profile . . . . .	57

## **Appendix**

Troubleshooting . . . . .	58
Standard of Product . . . . .	61

# Supplied Accessories

Make sure that the following accessories are provided with the product.

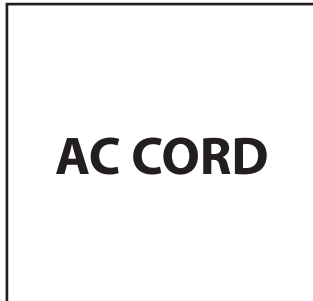

AC cord

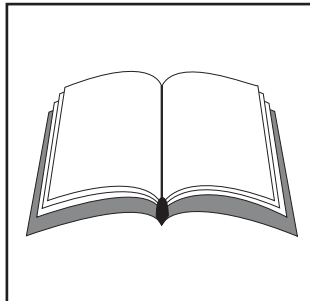

Instruction manual

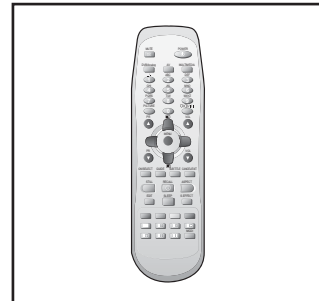

Remote controller

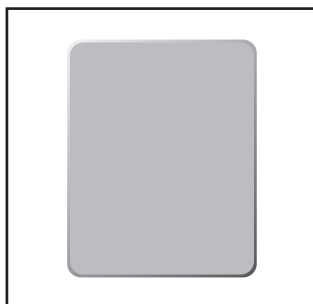

Microfiber Sheet (Only 32C1)



Cable Holder (only 32C1, 26/32/37C3)

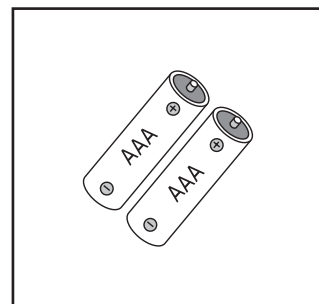

Batteries

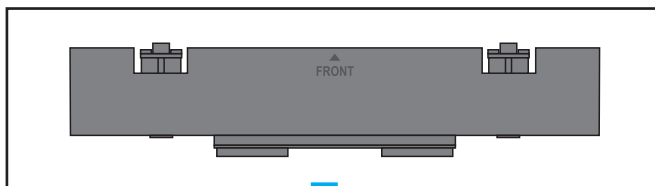

Cover Bottom

(When you install wall mounting you setup cover bottom like upper picture).

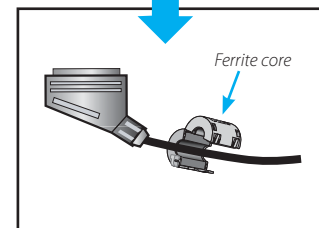
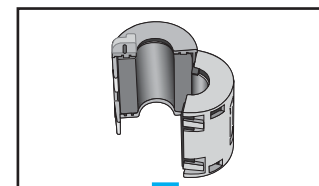

Ferrite core (32C1, 26/32C2, 26/32C3)

While using the Euro scart cable for connection, put the ferrite core to the end of the cable to prevent EMI (Electro Magnetic Interference).

## Note :

- You should follow the hanger instruction manual to install a TV set on the wall.



# Supplied Accessories

## The method of wire arrangement (32C1, 26/32/37C3)

1. Assemble the cable holder enclosed on the back of TV (picture 1). (ASSEMBLY METHOD: After you push the "A" (prominence part of cable holder) in the hole, rotate the cable holder clockwise as an angle of 90°. You can separate in reverse order of assembly.)
2. Open the cable holder (picture 2), you can open the cable holder that press and push "B" part.
3. After arrange lines with the cable holder, lock the "B" again (picture 3).

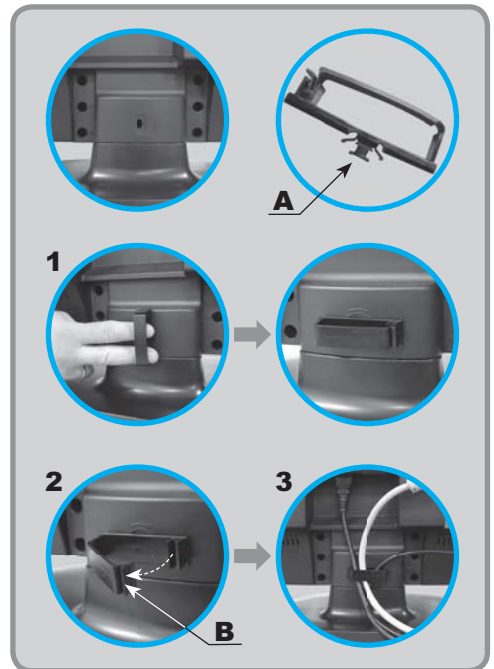

## The method of wire arrangement (26/32C2)

- After connecting the lines to the TV SET, you can pass the lines through the room of COVER WIRE, and then connect the lines to the other instruments.



# Antenna Connection

## Indoor Antenna Connection

1. Connect the feeder cable of the antenna to the combining adapter.

**WHEN THE IMAGE IS NOT CLEAR :** Unclear screen image and bad reception may be a cause of wrong antenna connection. Be sure to check its direction and place when installing.

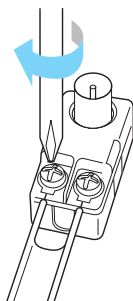

2. Connect the combining adapter to the antenna input at the left side of the TV set.

**WHEN USING THE COMBINING ADAPTER :** You may obtain the combining adapter at your closest Service Center.

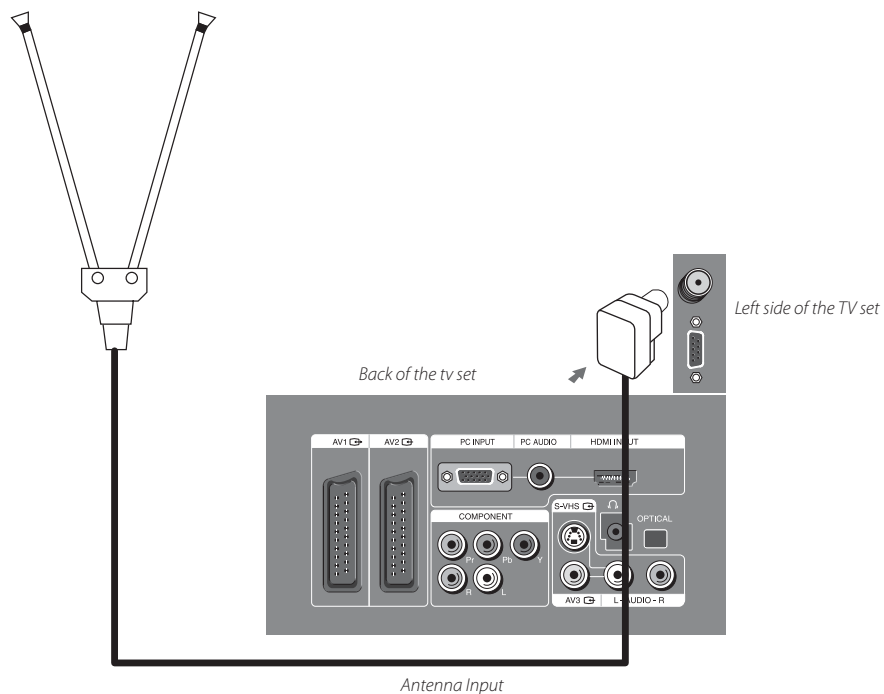

# Antenna Connection

## CTV Antenna Connection

Such community TV Antenna installation may be found in most of co-op apartments.

**When a coaxial cable is used :** Plug the coaxial cable to the antenna socket, and fix it firmly by turning it to the right.

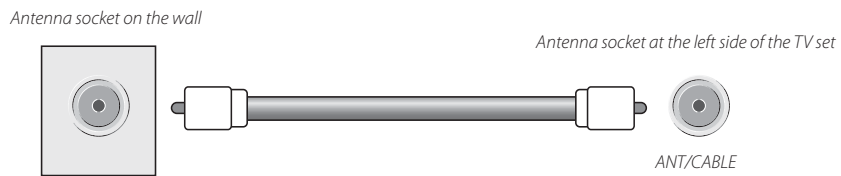

**When a feeder cable is used :** Plug the coaxial cable to the antenna socket, and fix it firmly by turning it to the right.

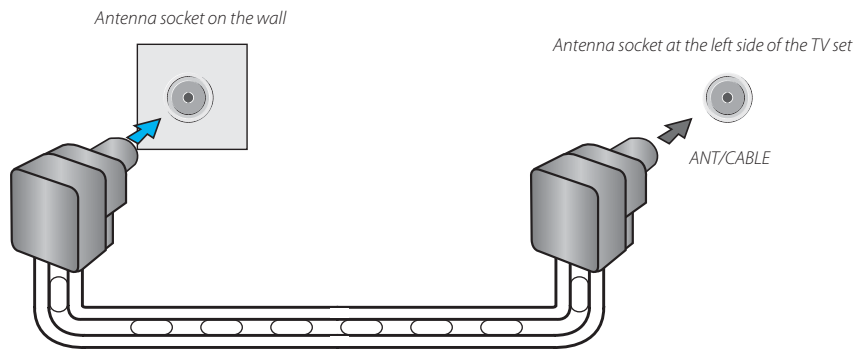

Feeder cable connection with the combining adapter

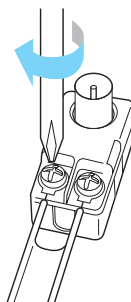

# Antenna Connection

## Outdoor Antenna Connection

Outdoor Antenna connection-such as VHF or/and UHF-may be necessary for installation at private houses.

### Single Antenna Connection

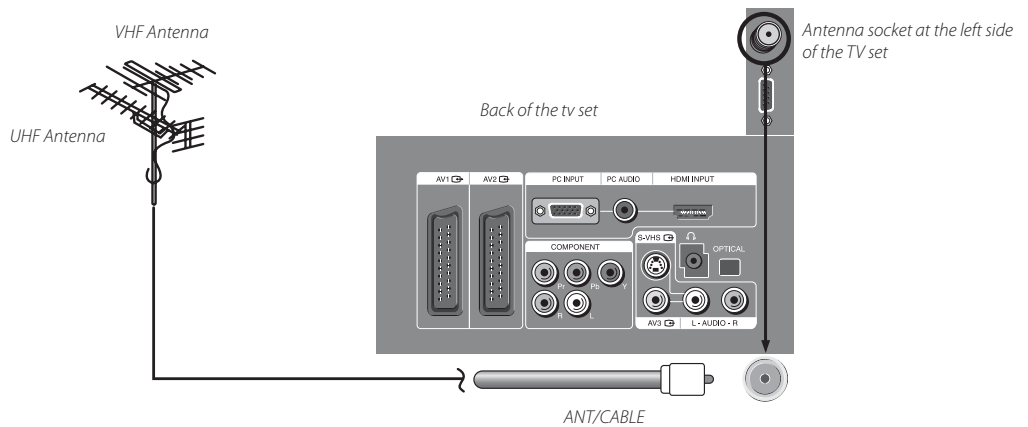

### Separate Antenna Connection.

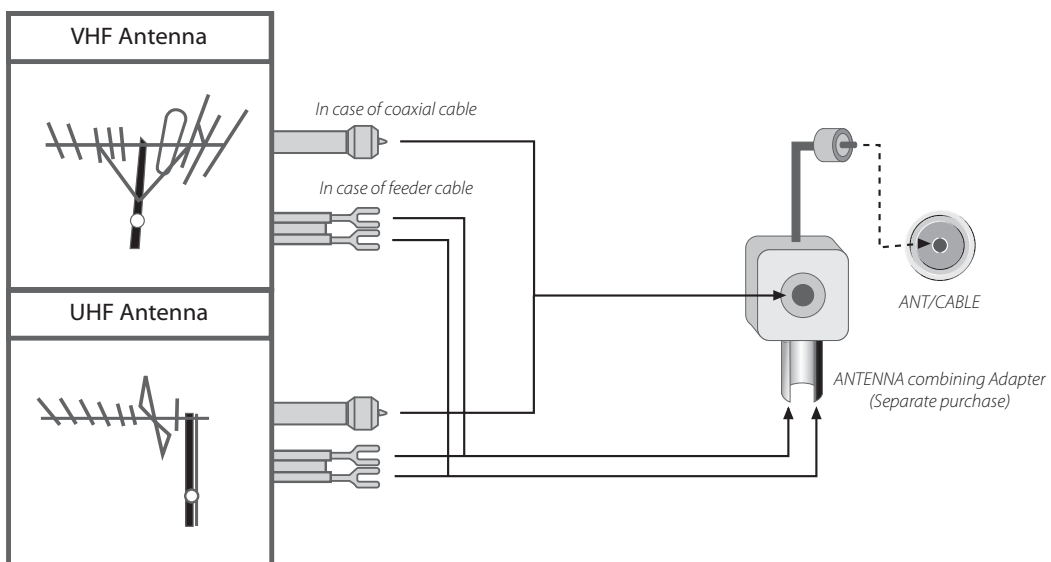

# Video Connection

## Connecting with an External Source

You may connect an S-Video input to enjoy clearer and brighter picture images. You can make the connection with the AV3 input.

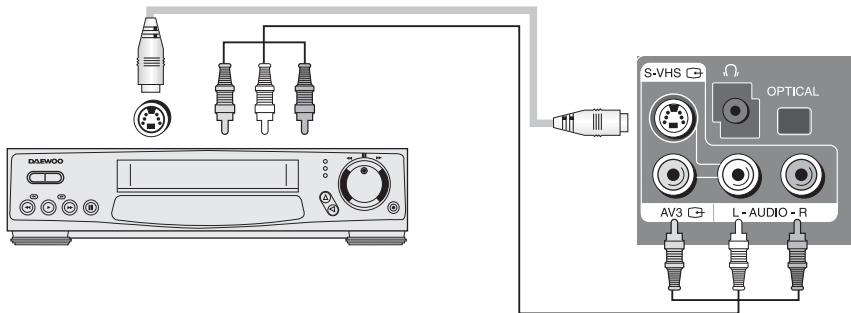

**Note :** If your AV device has both Video OUT terminal and S-Video OUT terminal, the S-Video connection is recommended for better picture quality.

## Connecting with SCART VIDEO

1. Prepare the scart lead for picture / sound.
2. Connect the SCART input / output terminal of video with the SCART1(AV1), SCART2(AV2), input/output terminal of TV.
3. Turn on the video, Insert the video cassette, and press the "PLAY" button.

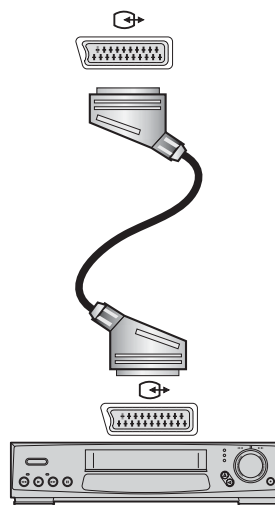

**Note :**

- SCART1 has CVBS/RGB input and RF output. It is used to connect a STB, VCR and DVD.
- SCART2 has CVBS input. It is used to connect a STB, VCR and DVD.

# Camcorder & Video Game Connection

## Watching the Camcorder Recording or Video Game on TV

1. Prepare the S-video and RCA connector.
2. These connectors connect to S-video or AV 3 as shown in the picture below.
3. Turn on the TV set and camcorder/video game.
4. Select AV3 or S-video mode, using the "AV" button of the Remote controller or "/↔" button of the TV set.

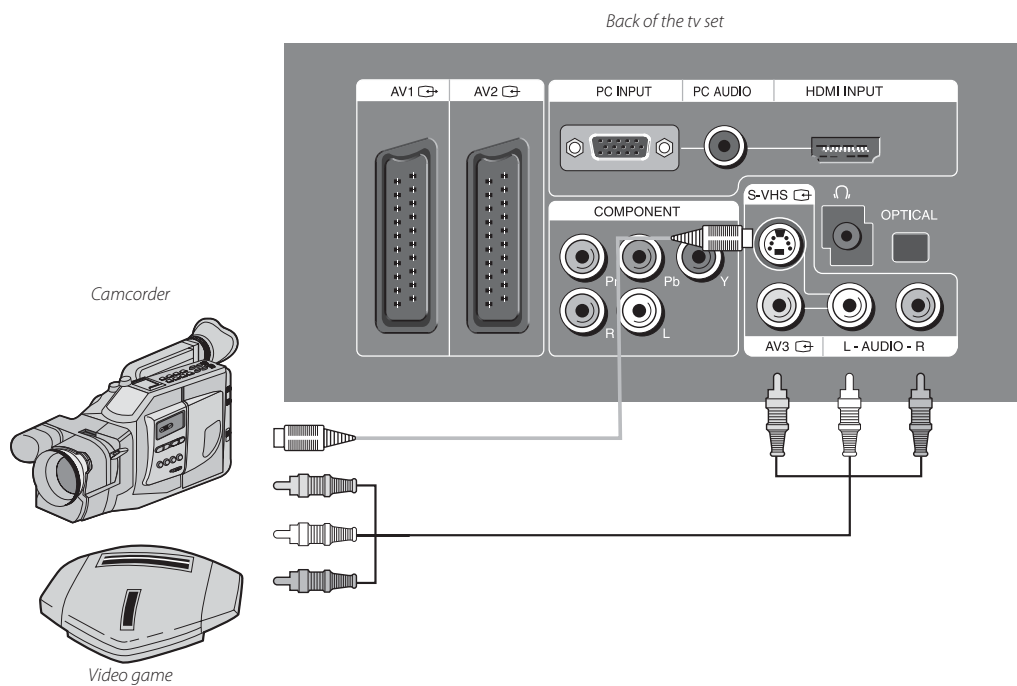

**Note :** If your AV device has both Video OUT terminal and S-Video OUT terminal, the S-Video connection is recommended for better picture quality.

# DVD player / STB (Set Top Box) connection

## When connecting with a component cable and Euro SCART cable

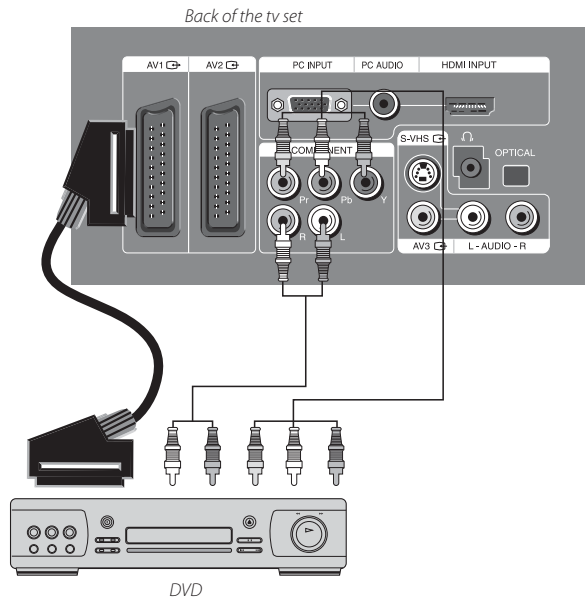

**Note :**

- When you connect with the component video, please check the colour of the cable between the DVD and TV set.

## When connecting with a S-VHS cable and RCA cable

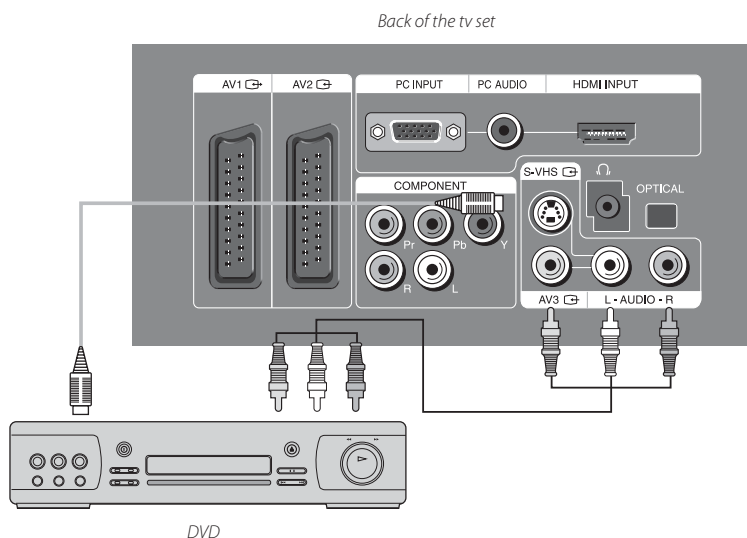

- Note :** If your AV device has both Video OUT terminal and S-Video OUT terminal, the S-Video connection is recommended for better picture quality.

# DVD player / STB (Set Top Box) connection

## When connecting with a HDMI cable

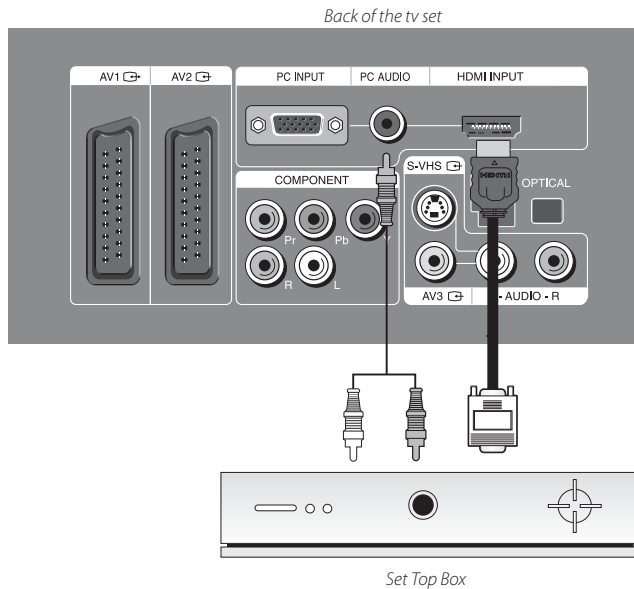

## When connecting with a component cable

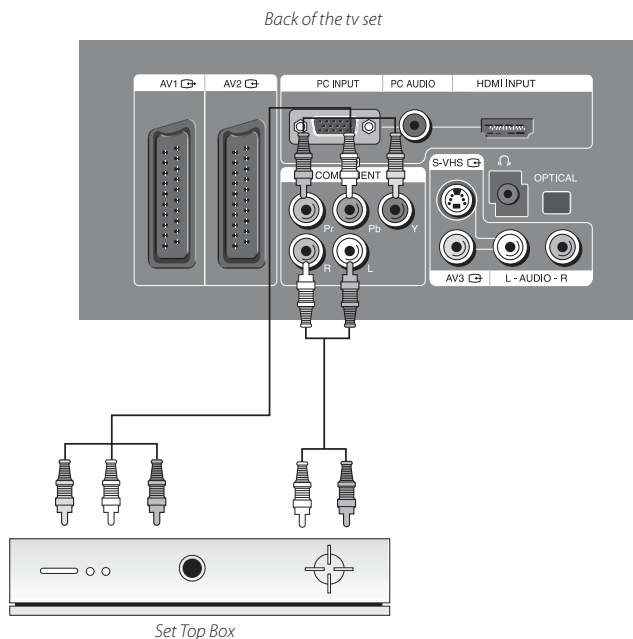

### Note :

- When you connect with the component video, please check the colour of the cable between the Set Top Box and TV set.



# PC Connection

## When connecting with PC(D-Sub) cable.

1. Adjust PC resolution to available resolution in LCD TV.
2. Connect between PC and TV set using the D-Sub and Audio cable like below the picture.
3. Turn on the PC and TV set.
4. Select PC mode by pressing 'Multimedia' button on the remote control or " $\square$ / $\rightarrow$ " button of the TV set.

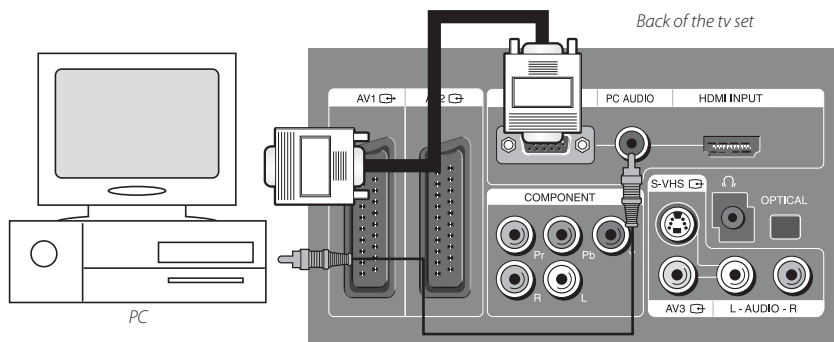

## When connecting with a HDMI cable.

1. Adjust PC resolution to available resolution in LCD TV.
2. Connect between PC and TV set using the HDMI and Audio cable like below the picture.
3. Turn on the PC and TV set.
4. Select HDMI mode by pressing 'Multimedia' button on the remote control or " $\square$ / $\rightarrow$ " button of the TV set.

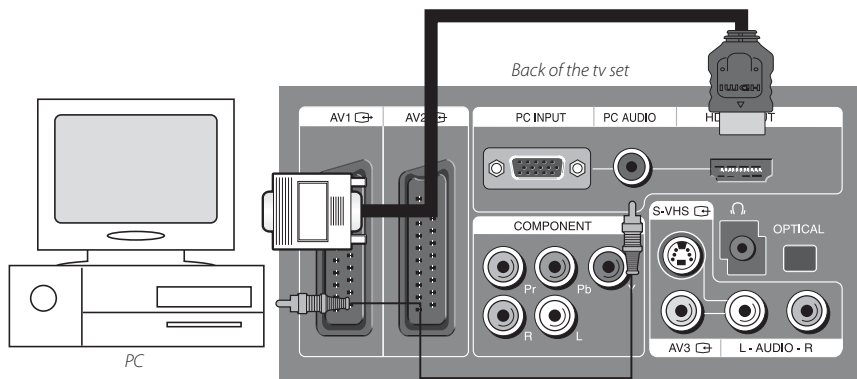

**Note :** If the graphic card of the PC only supports a DVI signal, you must connect the Audio cable as shown in the picture upper.

# PC Connection

## PC CONNECTION NOTES:

- 1) The resolution of the TV set is the best at 1360 x 768 (WXGA).
- 2) If there is a [Vertical Frequency] setting menu in the [Screen] Menu of the PC, adjust the frequency to 60Hz.
- 3) If the PC resolution is too high, it may be hard to read letters. Select a suitable resolution.
- 4) HDMI input port receives only Digital Signal.
- 5) Depending on the graphic card when plug & unplug the HDMI connection, the screen may not display correctly. Restart the computer if this happens.

## Multi input resolution available in LCD TV.

Resolution	V-freq	Component	PC(D-Sub)	HDMI	Standard
640 X 480	60Hz	x	o	o	VESA Standard
	72Hz	x	o	x	VESA Standard
	75Hz	x	o	o	VESA Standard
800 X 600	60Hz	x	o	o	VESA Standard
	72Hz	x	o	x	VESA Standard
	75Hz	x	o	o	VESA Standard
1024 X 768	60Hz	x	o	o	VESA Standard
	70Hz	x	o	x	VESA Standard
	75Hz	x	o	o	VESA Standard
1360 X 768	60Hz	x	o	o	VESA Standard
720 X 480i	60Hz	o	x	x	
720 X 480P	60Hz	o	x	o	
720 X 576i	50Hz	o	x	o	
720 X 576P	50Hz	o	x	o	
1280 X 720P	50Hz	o	x	o	
	60Hz	o	x	o	
1920 X 1080i	50Hz	o	x	o	
	60Hz	o	x	o	

### Note :

- When you connect with component, PC(D-Sub), and HDMI, you must check the input resolution of external devices.
- So if this mode is used at PC mode, the screen can be enlarged.

# Cable TV Broadcasting Connection

## External Input Connection Source

Watching cable television is only possible after you have subscribed to the local broadcasting company and installed a cable receiver. You may make the connection to any of the Component input and SCART input AV1, AV2.

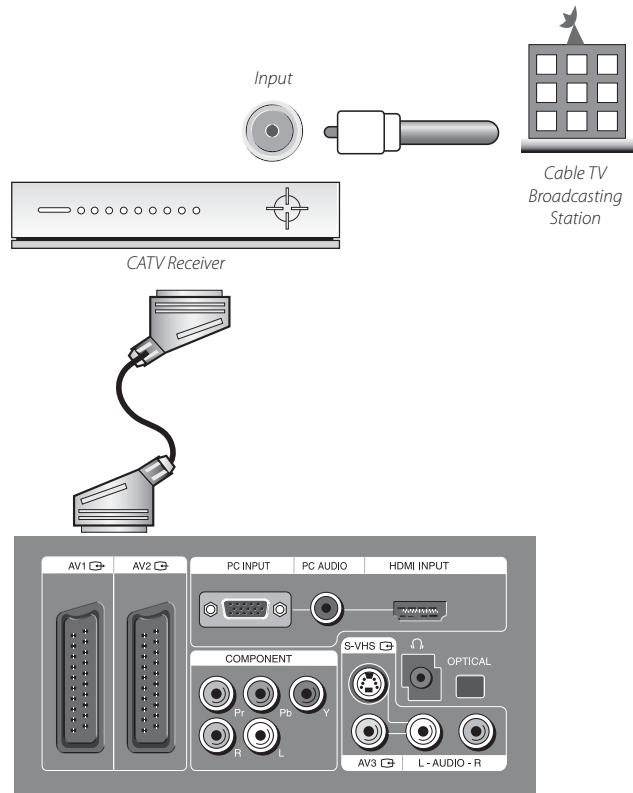

## Antenna Input Connection

Watching cable television is only possible after you have subscribed to the local broadcasting company and installed a cable receiver.

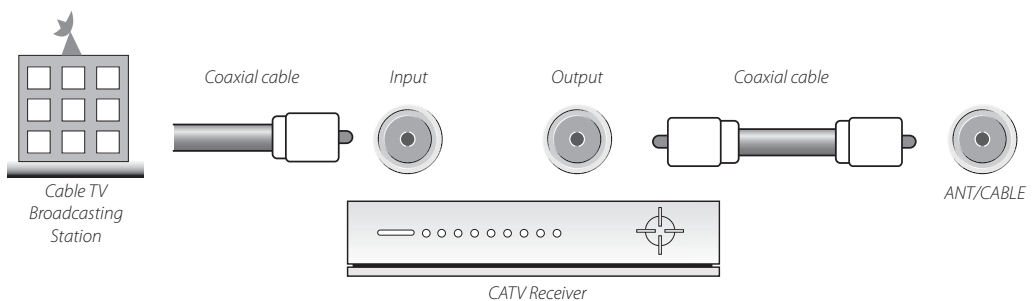

# Connect with the Dolby Digital AMP.

If you connect the optical output to a Dolby digital AMP, you can listen to better sound.

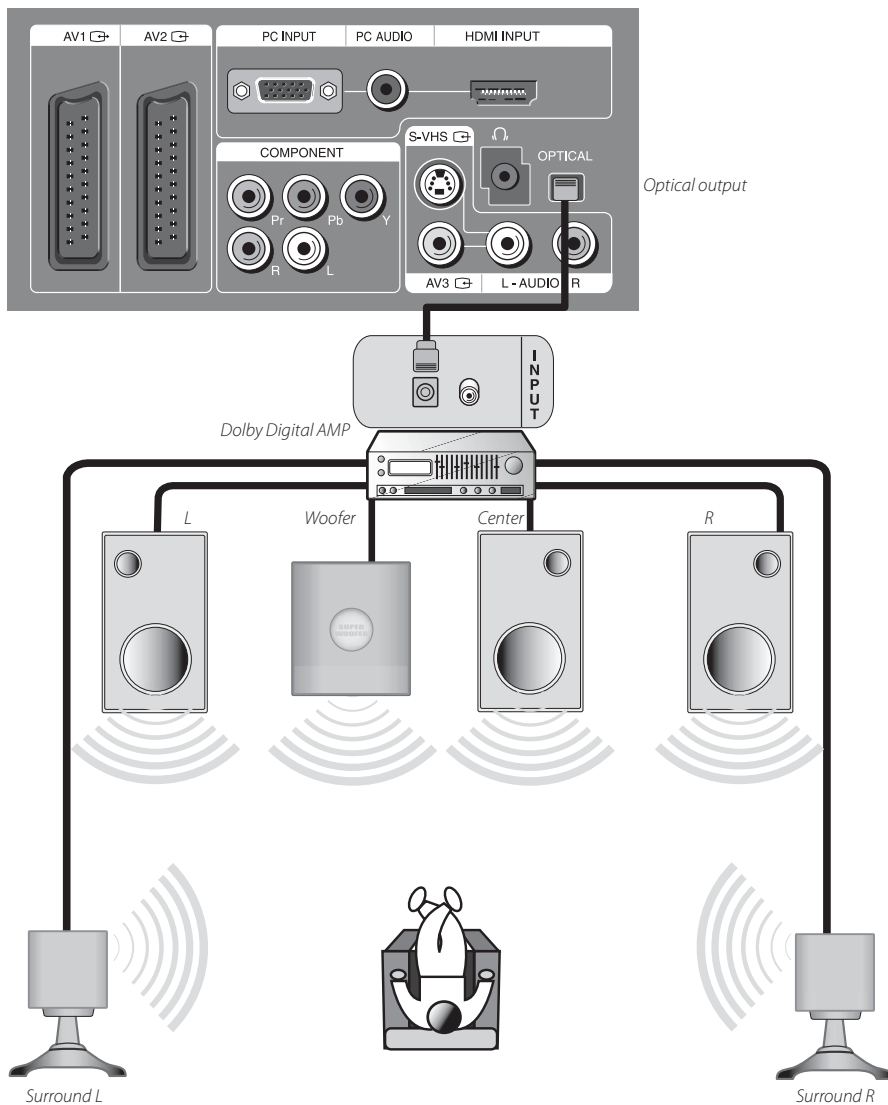

# Name of Each Part

## Front Panel (DLT-26C2/DLT-32C2)

Buttons on the TV set have the same functions as those of the remote controller.

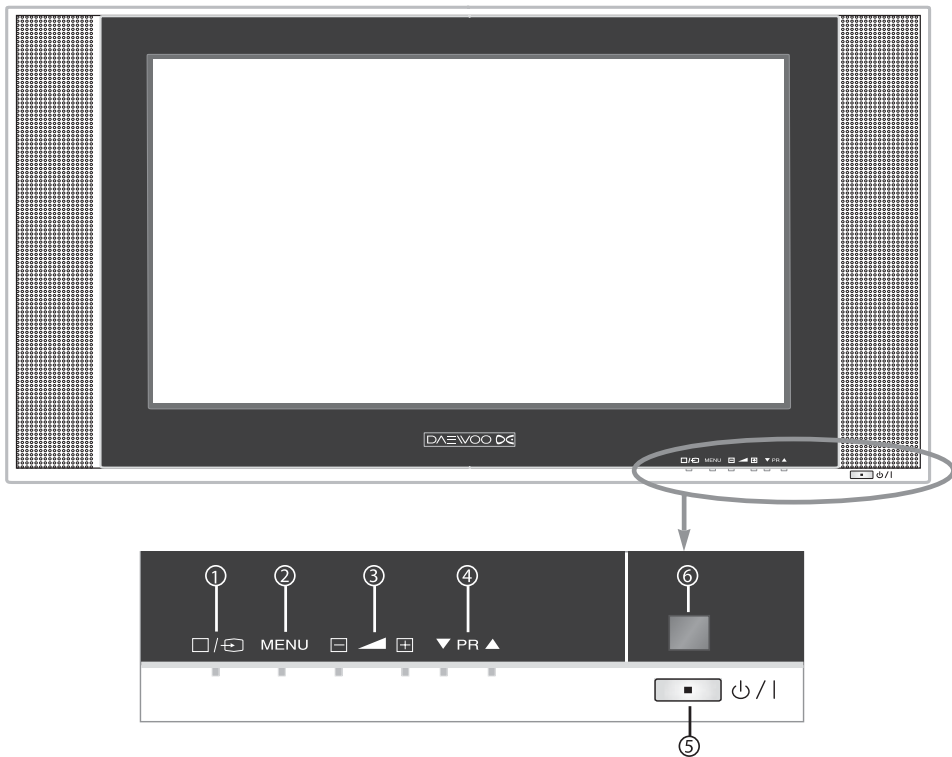

### Control Key Buttons.

- ① **□/→ Buttons** : Each time you press this button, the TV will cycle through:  
TV / AV1 / AV2 / AV3 / S-Video / Component / PC /HDMI / DVB-T
- ② **MENU Button** : Use this button to enter and exit the MENU.
- ③ **■/▲ Buttons** : Use these buttons to change your TV's volume or to move the cursor in the menu.
- ④ **▼PR ▲ PR Buttons** : Use these buttons to change channels on your TV or to move the cursor in the menu.
- ⑤ **Stand-by / TV ON button**  
⏻/| **Button** : Use this button to TV STAND-BY mode/TV ON mode.  
⏻/| **LED Indicator** : Lights up red in Stand-By mode and Lights up green in TV on mode.  
When TV is Child Lock mode, LED will cycle through red / green in Stand-By mode.
- ⑥ **Remote controller signal receiver** : The screen contains the remote controller signal receiving window; thus, point the remote controller towards the screen when using it.

# Name of Each Part

## Front Panel (DLT-26C3/DLT-32C1/DLT-32C3/DLT-37C3)

Buttons on the TV set have the same functions as those of the remote controller.

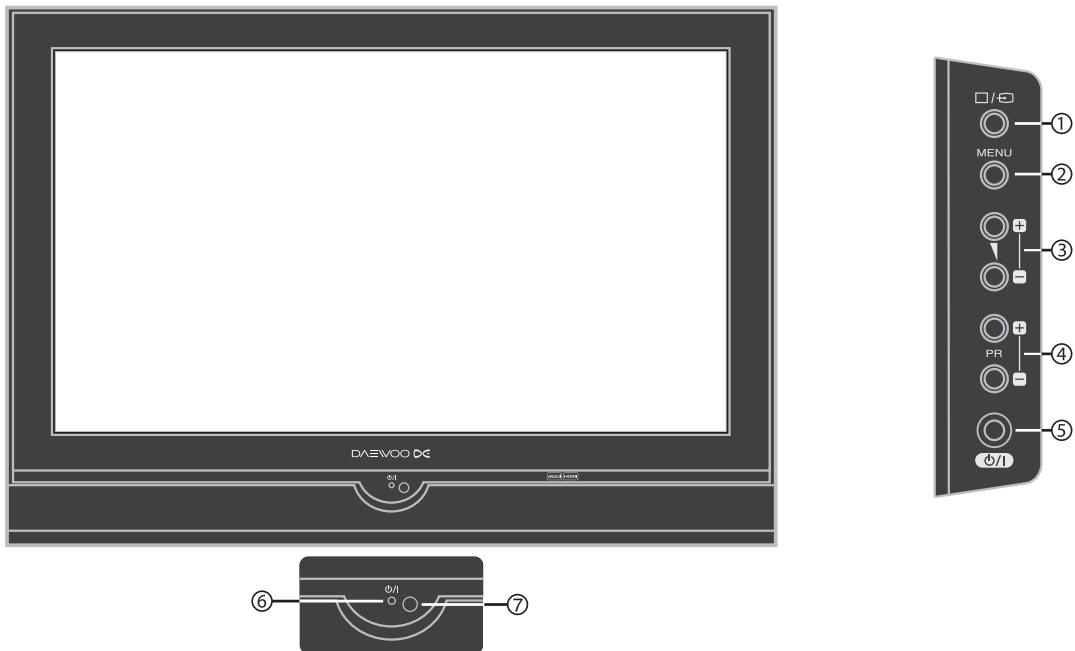

### Control Key Buttons.

- ① **□/⏻ Button** : Each time you press this button, the TV will cycle through:  
TV / AV1 / AV2 / AV3 / S-Video / Component / PC /HDMI / DVB-T
- ② **MENU Button** : Use this button to enter and exit the MENU.
- ③ **⏪ ⏩ Buttons** : Use these buttons to change your TV's volume or to move the cursor in the menu.
- ④ **PR PR Buttons** : Use these buttons to change channels on your TV or to move the cursor in the menu.
- ⑤ **Stand-by / TV ON button**  
⏻/⏻ **Button** : Use this button to change from TV STAND-by mode to TV ON mode.
- ⑥ **⏻/⏻ <LED Indicator>** : Light up red in Stand-By mode and Lights up green in TV on mode. When TV is Child Lock mode, LED will cycle through red / green in Stand-By mode.
- ⑦ **Remote controller signal receiver**  
The screen contains the remote controller signal receiving window; therefore, point the remote controller towards the screen when using it.

# Name of Each Part

## Side and Rear Panel

Left Side of the TV set

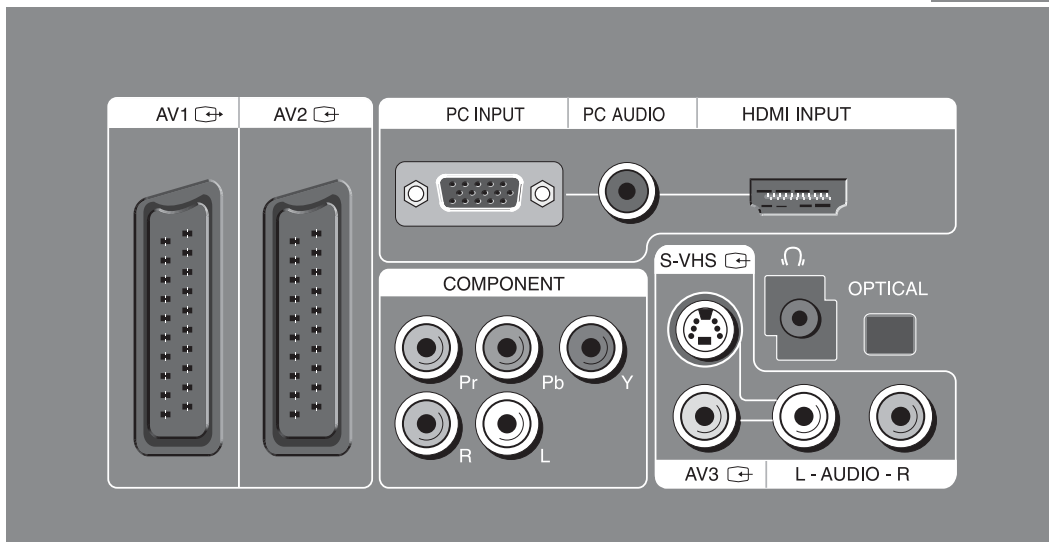
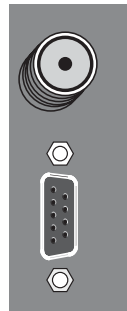

Rear Panel

# Parts of the Remote Controller



1. (MUTE) : Press this button, and the sound goes off. Press again, and the sound returns.
2. (POWER) : TV on/off button in Stand-By mode.
3. DVB/Analog : Each time you press this button, the TV will cycle through: Analog TV => DVB-T => Analog TV
4. AV : Each time you press this button, the TV will cycle through : TV => AV1 => AV2 => AV3 => S-Video => TV

**Note** : If TV is working in Analog mode, Screen will be unchanged analog mode into DVB-T mode when pressing the "AV" button on the remote controller. You should press the "DVB/Analog" button on the remote controller.

5. MULTIMEDIA : Each time you press this button, the TV will cycle through: Component => PC => HDMI => Component
6. NUMBER : Press the numbers on this board, you can select PR directly in TV mode.  
(EX. When you want to select PR10, you should press down "1" and "0" within 2 second. If you only press down "1", after 2 second, PR1 will be selected.)

**Note** : When the current state is ST-BY, you can turn on the TV using the digit key. Then programme is selected according to digit number.

7. PICTURE MODE : Picture modes change as follows : Normal => Cinema => Dynamic => Favourite => Normal
8. (MTS) : You can select sound mode in Mono, Stereo, Dual1, Dual2, NiCAM STEREO. It works only in Analog TV mode.
9. PR : Change channels on your TV.
10. VOL : Adjust the volume
11. Cursor (UP, DOWN, LEFT, RIGHT) : move the cursor (UP / DOWN / LEFT / RIGHT) in the menu.
12. MENU : Menu display button.
13. OK/SELECT: Confirm to change a part of the DVB-T menu (Program Guide, DVB Setup, etc.)
14. GUIDE : Access Electronic Program Guide (EPG). It works only in DVB-T mode.
15. SUB TITLE: Select the Subtitle Language. It works only in DVB-T mode.
16. CANCEL/EXIT: Exit from the DVB-T menu (Program Guide, DVB Setup, etc.)
17. RECALL [] : Display the present modes (Analog/DVB-T, AV/S-Video, Component, PC/HDMI) and Signal information for 4 seconds.

**Note** : In Analog TV mode, you can see information about the Programme number, Sound, and Clock. In DVB-T mode, you can see information about a channel number, name, broadcasting time, audio service and more.



# Parts of the Remote Controller



18. STILL : Press this button to freeze the picture

**Note** : It works only AV 1, AV 2, AV 3, S-VIDEO, Analog TV, DVB-T

19. ASPECT : Select screen aspect ratio :

Auto => 4:3 => 14:9 => Zoom 14:9 => Zoom 16:9 => 16:9 => Auto

**Note** : When current mode is multimedia ( PC, HDMI, Component), the aspect only work as the 16:9 mode.

20. EDIT : You can enter the channel edit mode. It works only in Analog TV mode.

21. SLEEP : Sleep Timer setting.

OFF => 15 => 30 => 60 => 90 => 120 => OFF

**Note** : If an active signal is not present for about 30 minutes, the set will automatically turn to ST-BY mode.

22. SOUND EFFECT : Using this button, Select the desired sound mode. Flat => 3D Panorama => Super Bass => Speech => Flat

23. Red button : Skip the channel in EDIT and teletext.

24. Green button : Move the channel in EDIT and teletext.

25. Yellow button : Delete the channel in EDIT and teletext.

26. Teletext : See page 45.

27. MGDl : Using this button, Change MGDl mode (on/Demo, Only In Analog TV/DVB-T, AV 1~3, S-Video mode).

## Inserting Batteries into the Remote Control Unit

To load the batteries, turn the remote control handset over and open the battery compartment. Insert the batteries (Two 1.5v, type AAA).

Make sure that the polarity matches with the (+) and (-) marks inside of the battery compartment.

**Note** : To avoid damage from possible battery leakage, remove the batteries if you do not plan to use the remote control handset for an extended period of time.

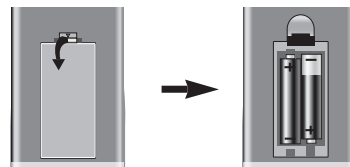

# Method To Use Basic Menu

## Basic Menu

- The basic menu appears on the screen if you press the menu button of the remote control.
- There are 5 items Picture, Sound, Screen, Utilities, and Setup in the basic menu.
- Each item has sub-items under it. If the desired item is selected, the relevant sub-items are displayed upward.

### 1. Press the "MENU" button.

- The main menu appears if you press the "MENU" button.

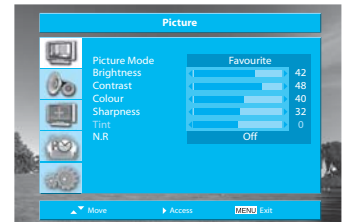
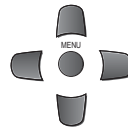

### 2. Press the "▲UP/DOWN▼" button.

- You may setup according to the directions on the screen after selecting the desired item by pressing the "▲UP/DOWN▼" button.
- If the setup is completed, exit from the menu by pressing the "Menu" button.

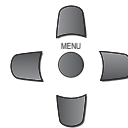

**Picture** : Adjusts Picture Mode, Brightness, Contrast, Colour, Sharpness, Tint (NTSC only) and N.R



**Sound** : Adjusts Sound Effect, AVC, Balance and Equalizer



**Screen** : Adjusts Colour temp, Component / PC / HDMI (Component / PC / HDMI mode only)



**Utilities** : Adjusts Child Lock and Timer



**Setup** : Adjust Auto setup, Manual tuning and EDIT in Analog TV mode  
Adjust Auto Setup and System in DVB-T mode

# To Watch TV

## On/Off, Number, Mute, RECALL[ⓘ], ▼PR▲, ▼VOL▲

Buttons with same name in the main body performs the same function.

Press the  / | “**ON/OFF**” button of the front or right side of the set or the “**POWER**” button of Remote controller.

- You can also turn on the TV using “▼PR▲” or digit key in the ST-BY mode.

### Note :

- The buttons of the remote control and the main body operate only when AC power turn on.
- You must pull out the plug of TV set to shut off the AC Power

When pressing the Program button

- Select two digits if using the number button for channel selection. For example, to watch the No.9 channel, Press the number button “0” and “9”. If pressing only number “9” button, it takes longer time to select the channel.

To suddenly turn sound off

- Press the “**MUTE** (⊗)” button.
- No sound is heard if “**MUTE**(⊗)” is displayed on the screen.
- Sound is heard again if you press the “**MUTE** (⊗)” button once again.  
For example, please use this button when telephone rings or when guest comes while watching TV.



Check of TV operation status

- If pressing the “**RECALL** [ⓘ]” button, status of channel or clock broadcasting being currently watched or entry status of video component is displayed on the screen.

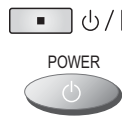

# To Watch TV

## 1. Press the “ / | (ON/OFF)” button of the front or right side of the set or the “POWER” button of Remote controller.



- The Stand-by LED lamp turns on in red colour.
- Press “ PR 

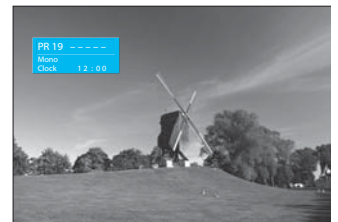

## 2. Press the “ PR - Select the desired program by pressing the “ PR



## 3. Adjust volume.

- Sound reduces by pressing the “ VOL” button.
- Sound increases by pressing the “VOL 

**Note :** Sound mutes by pressing the “MUTE” () button.

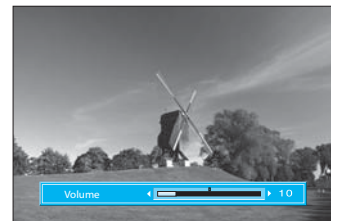

## 4. Press the “ / | (ON/OFF)” button of the front or right side of the set or the “POWER” button of Remote controller for turning the TV off.

- TV turns off and the power lamp changes to red colour.

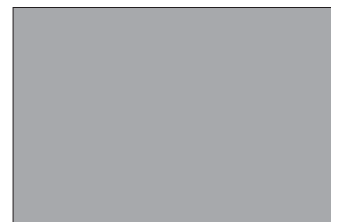
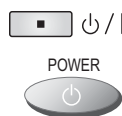

# Setting Up TV Stations

## Auto Tuning

- All stations that can be received are stored by this method. It is recommended that you use Auto tuning during installation of this set.

### 1. Press the "Menu" button to select the Setup menu.

- Move the selection bar to the **Setup** menu with "▲UP/DOWN▼" buttons.

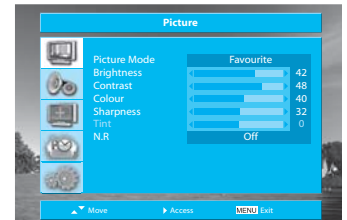
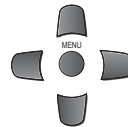

### 2. Select the "Auto Setup"

- Place the selection bar on **Auto Setup** and press the "RIGHT▶" button.

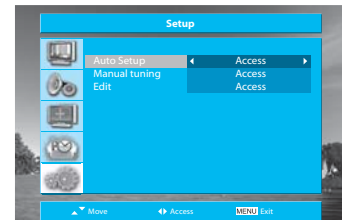
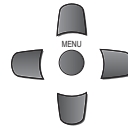

### 3. Select the country you require with "◀LEFT/RIGHT▶" button.

- After select the country, place the selection bar on **Start** and press the "RIGHT▶" button to start Auto setup.

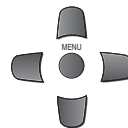

### 4. Please wait until the Setup menu appears.

- If you don't want to edit program now, escape from menu with the "Menu" button.

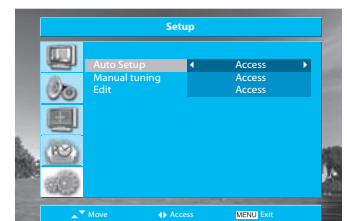
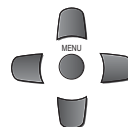

# Setting Up TV Stations

## Manual tuning

**The Manual tuning menu shows you information as follows:**

- System information: GB, France, E/Euro, W/Euro.
- Program number, Station name and Real channel number, frequency.

### 1. Locate the selection bar on the Manual tuning at the Setup menu.

- Press the menu button to select the **Setup** menu.
- Move the selection bar to the Setup menu with "**▲UP/DOWN▼**" buttons.
- Place the selection bar on **Manual Tuning** and press the "**▶RIGHT▶**" button.

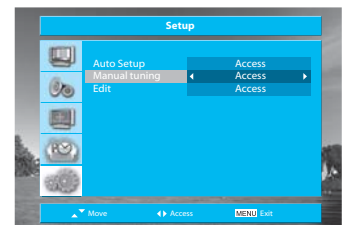
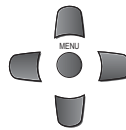

### 2. Searching for channel in the Manual Tuning Menu.

- Move the selection bar to the **Search** with "**▲UP/DOWN▼**" buttons.
- Press the "**◀LEFT/RIGHT▶**" buttons to search up or down.
- Searching will be stopped automatically after finding the next channel.

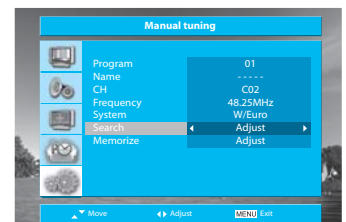
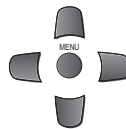

### 3. Memorizing to store the Program.

- Move the selection bar to the **Memorize** with "**▲UP/DOWN▼**" buttons and press the "**▶RIGHT▶**" button.
- After searching a station, you must memorize to store the Program.

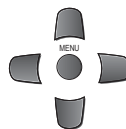

### Note :

- If you are unable to get any programs using Auto Tuning because of a poor broadcasting signal, it is possible to store the Manual tuning.
- You can change the Programme number in the Edit mode.
- Manual tuning does not support this function.

# Setting Up TV Stations

## Manual tuning

### 4. Searching for channel.

- Move the selection bar to the **Program** with “▲UP/DOWN▼” buttons.
- Select a programme number you want to tune finely with the “◀LEFT/RIGHT▶” buttons.
- Move the selection bar to the **System** and select a system which you want.

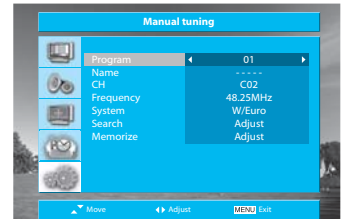
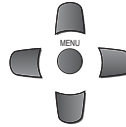

### 5. Enter a station name.

- Move the selection bar to the **Name** with “▲UP/DOWN▼” buttons.
- You can enter a station name with the “▲UP/DOWN▼”、“◀LEFT/RIGHT▶” buttons.

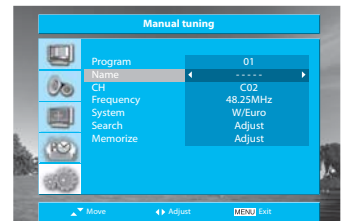
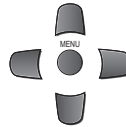

### 6. Search a channel finely.

- Move the selection bar to the **CH** with “▲UP/DOWN▼” buttons.
- Search a real channel with the “▲UP/DOWN▼”、“◀LEFT/RIGHT▶” buttons.
- Move the selection bar to the **Frequency** by pressing “▲UP/DOWN▼” buttons
- Adjust the Frequency with the “◀LEFT/RIGHT▶” buttons.

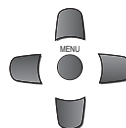

### Note :

- If you are unable to get a good picture or Sound because of a poor broadcasting signal, adjustment of Frequency might improve it.
- After tuning, you must memorize to store the Program.
- The alphabet below OSD in the Setup menu only display on English.
- This part does not other language except English.

# Setting Up TV Stations

## Edit

The Edit menu shows you information as follows:

- Program position assignment: Program number, Real channel number, Station name and Skip.

### 1. Skipping the Programs.

- Move to **EDIT** in the **Setup** menu and press the "RIGHT▶" button.
- Move the selection bar to program number to skip with the "▲UP/DOWN▼"/"◀LEFT/RIGHT▶" buttons.
- Press the "Skip(Red)" button, then the **Skip** will be changed to Yes from No.



Program	CH	Name	Skip
PR96	C21	.....	yes
PR97	C21	.....	yes
PR98	C21	.....	yes
PR99	C21	.....	yes
PR00	C21	.....	yes
PR01	C02	.....	no
PR02	S07	.....	no
PR03	C18	.....	no
PR04	S12	.....	no
PR05	S19	.....	no

### 2. Moving the program positions.

- Move to **EDIT** in the **Setup** menu.
- Press the "Move(Green)" button. The colour of Character will be changed to Orange from Black.
- Move the selection bar to new program number.
- Press the "Move(Green)" button again, then the programs are changed.



Program	CH	Name	Skip
PR96	C21	.....	yes
PR97	C21	.....	yes
PR98	C21	.....	yes
PR99	C21	.....	yes
PR00	C21	.....	yes
PR01	C02	.....	no
PR02	S07	.....	no
PR03	C18	.....	no
PR04	S12	.....	no
PR05	S19	.....	no

### 3. Deleting the program positions.

- Move to **EDIT** in the **Setup** menu.
- Move the selection bar to program number you want to delete.
- Press the "Delete(Yellow)" button.



Program	CH	Name	Skip
PR96	C21	.....	yes
PR97	C21	.....	yes
PR98	C21	.....	yes
PR99	C21	.....	yes
PR00	C21	.....	yes
PR01	C02	.....	no
PR02	S07	.....	no
PR03	C18	.....	no
PR04	S12	.....	no
PR05	S19	.....	no

### Note :

- You can move the selection bar 1 step with "▲UP/DOWN▼" buttons and 10 steps with the "◀LEFT/RIGHT▶" buttons.



# Selection of AV and Multimedia Input Signal

## When watching video, Camcorder, DVD, Cable TV with AV

- See page 12 for connection method of TV and "Video"
- When pressing "□/⊞" button on the TV set, screen changes as follows:  
Analog => AV1 => AV2 => AV3 => S-Video => Component => PC => HDMI => DVB-T => Analog

### 1. Press the "AV" button on the remote controller.

- Screen changes as follows whenever pressing the "AV" button:  
Analog(or DVB-T) => AV1 => AV2 => AV3 => S-Video => Analog(or DVB-T)



### Note :

#### ※ Cautions in menu setup

- If TV is working in Analog mode, Screen will be unchanged analog mode into DVB-T mode when pressing the "AV" button on the remote controller. You should press the "DVB/Analog" button on the remote controller.
- If sound signal is mono method, connect it to the L-terminal of the sound input terminal.

# Selection of AV and Multimedia Input Signal

## When connecting PC, STB, DVD with Multimedia

### 1. Press the "MULTIMEDIA" button on the remote controller.

- Screen changes as follows whenever pressing the "MULTIMEDIA" button.  
Component => PC => HDMI => Component



### HDMI & PC mode

1. For optimum picture quality, use 1360x768 computer at a 60Hz refresh rate. Using other formats or refresh rates may result in reduced picture quality.
2. If the message 'No signal' appears on the screen, adjust the PC output to a format listed in the Multimedia Input table.

### Multimedia Input Format

Resolution	V-freq	Component	PC(D-Sub)	HDMI	Standard
640 X 480	60Hz	x	o	o	VESA Standard
	72Hz	x	o	x	VESA Standard
	75Hz	x	o	o	VESA Standard
800 X 600	60Hz	x	o	o	VESA Standard
	72Hz	x	o	x	VESA Standard
	75Hz	x	o	o	VESA Standard
1024 X 768	60Hz	x	o	o	VESA Standard
	70Hz	x	o	x	VESA Standard
	75Hz	x	o	o	VESA Standard
1360 X 768	60Hz	x	o	o	VESA Standard
720 X 480i	60Hz	o	x	x	
720 X 480P	60Hz	o	x	o	
720 X 576i	50Hz	o	x	o	
720 X 576P	50Hz	o	x	o	
1280 X 720P	50Hz	o	x	o	
	60Hz	o	x	o	
1920 X 1080i	50Hz	o	x	o	
	60Hz	o	x	o	

### Note :

- When you connect with component, PC(D-Sub), and HDMI, you must check the input resolution of external devices.
- So if this mode is used at PC mode, the screen can be enlarged.

# Screen Adjustment

## When setting up various screen modes

- The user may select various screens designed for a good picture without adjusting the brightness, contrast or colour individually.

### 1. Pressing the "PICTURE" button.

- Screen changes as follows whenever pressing the "PICTURE" button.  
Normal => Cinema => Dynamic => Favourite => Normal
- The screen adjustment status changes as the following screens are displayed sequentially whenever pressing the "Picture" button.
- The screen returns to the mode prior to turning power off when then turning power on again.

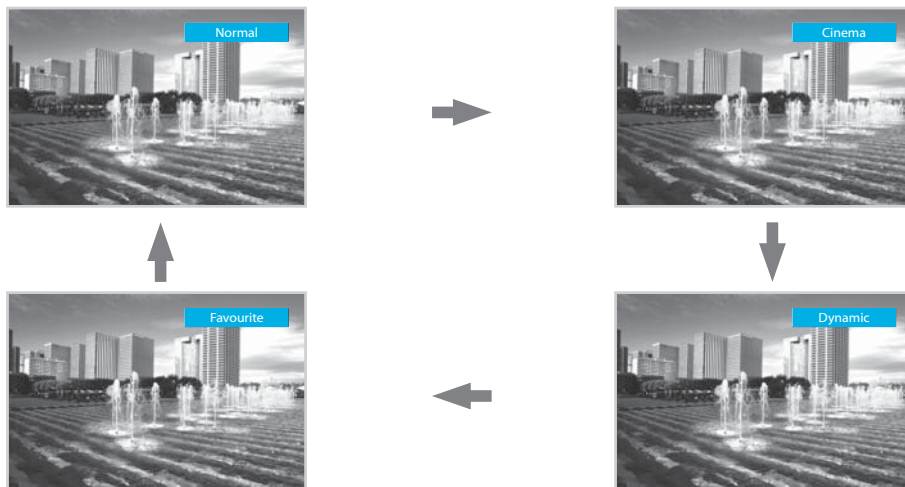

### Note :

- **Normal** : For a highly defined image in a normally bright room.
- **Cinema** : Ideal for movies.
- **Dynamic** : For a clear-cut image emphasizing high contrast for sports viewing.
- **Favourite** : Allows the user to customize settings as desired.

# Screen Adjustment

## When adjusting the screen to taste

- You can enjoy various screens by adjusting Brightness, Contrast, Colour, Sharpness, etc to the user's taste.

### 1. Select Picture by pressing the "Menu" button.

- The menu screen appears as follows.

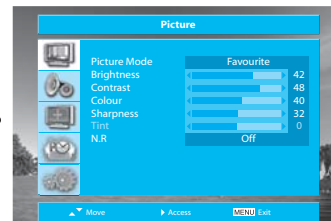
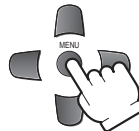

### 2. Select and adjust each item.

- Move to the **PICTURE** menu.
- Whenever pressing the "▲UP/DOWN▼" buttons, you can select in the order of Brightness, Contrast, Colour, Sharpness and N.R.
- You can adjust all items by pressing the "◀LEFT/RIGHT▶" buttons.

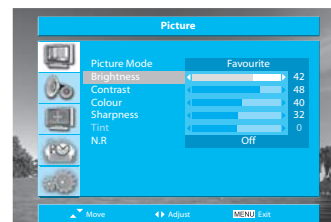
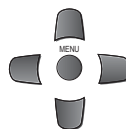

#### Note :

- **Brightness** : Adjusts the whole of screen brighter or darker.
- **Contrast** : Adjusts difference between brightness and darkness between objects and background on the screen.
- **Colour** : Adjusts colour saturation.
- **Sharpness** : Adjusts outline of the screen smoothly or sharply.
- **N.R.** Reduce the noise in the picture due to poor reception or poor picture quality (Only In Analog TV/DVB-T, AV 1~3, S-Video mode).

#### Note :

- **Tint** activates when receiving a NTSC signal.
- The adjusted levels are stored automatically in Favourite mode.

# Screen Adjustment

## Adjustment of Screen Size in TV and AV mode

- Randomly change the size of the screen.
- The AUTO screen operates when power is turned on firstly.

### 1. Pressing the "ASPECT" button on the remote controller.

- The screen changes as below whenever pressing the "Aspect" button.  
Auto => 4:3 => 14:9 => Zoom 14:9 => Zoom 16:9 => 16:9 => Auto

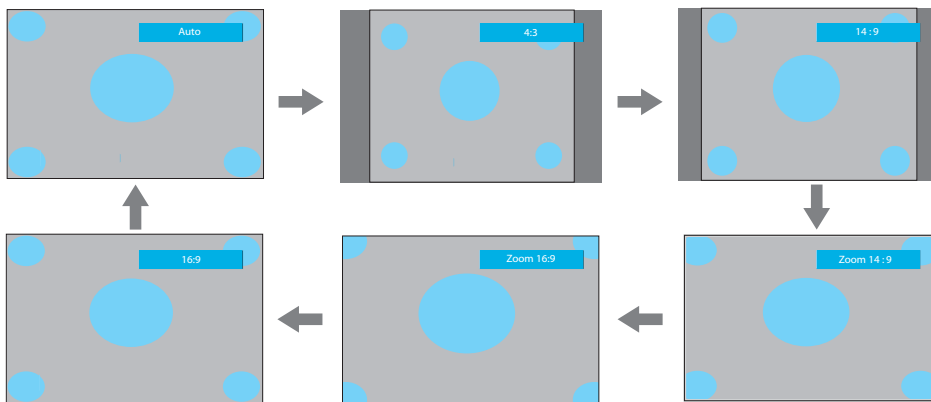
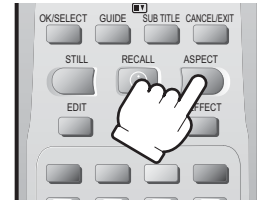

- **Auto** : This mode will display depending on the signal information of a broadcasting station.
- **4:3** : General TV screen currently broadcasted.
- **14:9** : 14:9 will display a 14:9 picture at its standard 14:9 size without any stretching.
- **Zoom 14:9** : Screen vertically enlarges image bigger than 14:9 image.
- **Zoom 16:9** : Screen enlarges image bigger than 16:9 image.
- **16:9** : 16:9 will display a true 16:9 (anamorphic) picture with no aspect distortions.

### Notices:

- "Aspect" function is not available in Multimedia (PC, HDMI, and Component) mode.
- "WSS" mode like 16:9 is only available with CVBS signal.

## Adjustment of Colour Temperature in TV

- Through colour temperature control, you can change the tone of colour

### 1. Select the Colour Temp from the Screen menu.

- Using the "◀LEFT/RIGHT▶" buttons, select the desired Colour Temperature.  
Normal => Warm => Cool => Normal

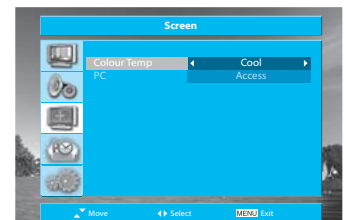
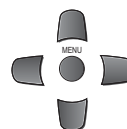

### Note :

- **Normal** : Normal White
- **Warm** : Reddish white
- **Cool** : Bluish white

# Screen Adjustment

## Adjustment of Screen in PC mode

### 1. Select the PC from the Screen menu.

- Press the "RIGHT▶" button and the PC mode appears.
- Press the "▲UP/DOWN▼" buttons to adjust the horizontal position of displayed image.

### 2. Adjustment of the H Position.

- Move to **H Position** in the PC menu.
- Press the "◀LEFT/RIGHT▶" buttons to adjust the horizontal position of displayed image.

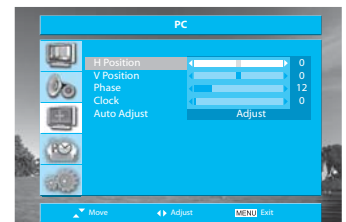
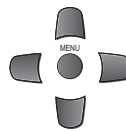

### 3. Adjustment of the V Position.

- Move to **V Position** in the PC menu.
- Press the "◀LEFT/RIGHT▶" buttons to adjust the vertical position of displayed image.

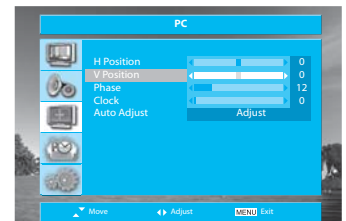
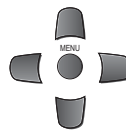

### 4. Adjustment of the Phase.

- Move to **Phase** in the PC menu.
- Press the "◀LEFT/RIGHT▶" buttons to adjust the phase to get a clearer picture.

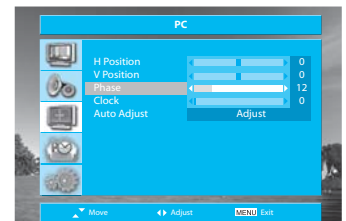
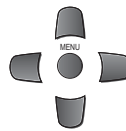

### 5. Clock.

- Move to **Clock** in the PC menu.
- Press the "◀LEFT/RIGHT▶" buttons to adjust the Clock to get optimal resolution.

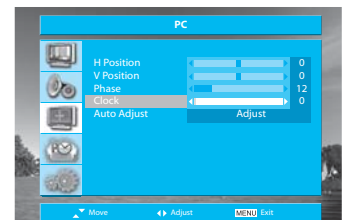
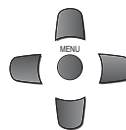

# Screen Adjustment

## 5. Auto Adjust.

- Move to **Auto Adjust** in the **PC** menu.
- Press the “◀LEFT/RIGHT▶” buttons to detect optimal resolution automatically.

### Note :

- You can adjust the PC menu only in the PC mode.
- During the Auto Adjust, you must not alter a screen on the monitor.
- During the moving picture, Auto Adjust is able to incorrectly work. So you must execute Auto Adjust in still image.
- Auto Adjust incorrectly work at a part graphic card or picture.
- When Auto Adjust is not correctly working, you can adjust with H/V position, phase and clock.

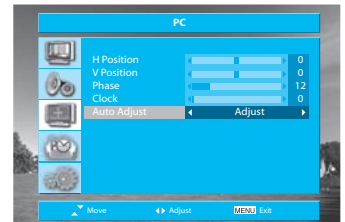
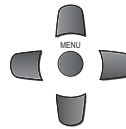

## Adjustment of Screen in Component mode

### 1. Adjustment of the H Position.

- Select the **Component** from the screen menu and press the “RIGHT▶” button.
- Move to **H Position** in the **Component** menu.
- Press the “◀LEFT/RIGHT▶” buttons to adjust the horizontal position of displayed image.

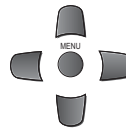

### 2. Adjustment of the V Position.

- Move to **V Position** in the **Component** menu.
- Press the “◀LEFT/RIGHT▶” buttons to adjust the vertical position of displayed image.

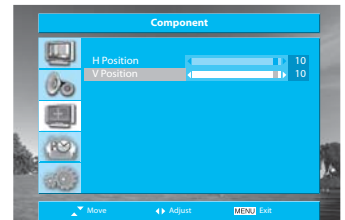
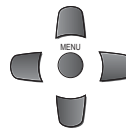

### Note :

- You can adjust the Component menu only in the Component mode.

## Adjustment of Screen in HDMI mode

### 1. Adjustment of the H Position.

- Select the **HDMI** from the screen menu and press the “RIGHT▶” button.
- Move to **H Position** in the **HDMI** menu.
- Press the “◀LEFT/RIGHT▶” buttons to adjust the horizontal position of displayed image.

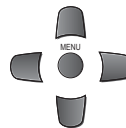

### 2. Adjustment of the V Position.

- Move to **V Position** in the **HDMI** menu.
- Press the “◀LEFT/RIGHT▶” buttons to adjust the vertical position of displayed image.

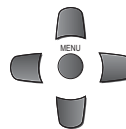

### Note :

- You can adjust the HDMI menu only in the HDMI mode.

# Sound Adjustment

## When selecting various sound modes

### 1. Sound mode selects what you want.

- Press the "S.EFFECT" button, then the sound status changes as followed :  
Flat => 3D Panorama => Super Bass => Speech => Flat

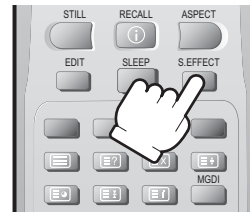

### Note :

- **Flat** : Suitable for watching any motion picture or allows the user to adjust as desired.
- **3D Panorama** : Makes virtual surround sound at the left and right speaker by developing the existing surround system function.
- **Super Bass** : Suitable for the bass effect.
- **Speech** : Allows human voice to be heard more clearly.



# Sound Adjustment

## When adjusting sound to taste

- The user can enjoy various the sounds by adjusting Sound Effect, AVC, Balance and Equalizer.

### 1. Select Auto Volume Control.

- Move to **AVC** in the **Sound** menu.
- Select either AVC ON or OFF using the “◀LEFT/RIGHT▶” buttons.

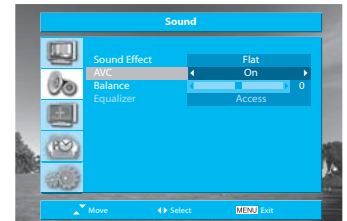
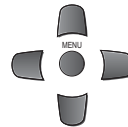

### 2. Adjust the Balance level.

- Move to **Balance** in the **Sound** menu.
- Adjust the balance level by using the “◀LEFT/RIGHT▶” buttons.

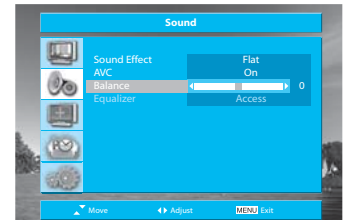
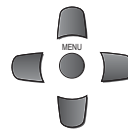

### 3. Adjust the audio Equalizer.

- Move to **Equalizer** in the **Sound** menu.
- Press the “RIGHT▶” button and the Equalizer mode appears.
- Select and use the relevant frequency by pressing the “▲UP/DOWN▼” buttons.
- You can adjust the degree of the frequency by using the “◀LEFT/RIGHT▶” buttons.

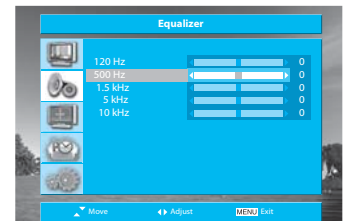
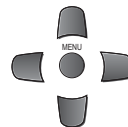

### Note :

- You can adjust the audio equalizer only in the **Flat** mode.
- Whenever you adjust the audio equalizer, it stores in the **Flat** mode.
- Equalizer : High quality sound range adjustment method used for audio product.

120 Hz, 500 Hz: Low sound range

1.5 kHz, 5 kHz: Middle sound range

10 kHz: High sound range

# Sound Adjustment

## Multi-Sound and Stereo

### 1. Mono Sound Selection.

- In Stereo reception if the stereo is weak, you can switch to MONO by pressing the "□/○/||/|| (MTS)" button. Then the colour of "MONO" character will be change to Black. In Mono reception the depth of sound is improved.
- To switch back to stereo, press the "□/○/||/|| (MTS)" button again.

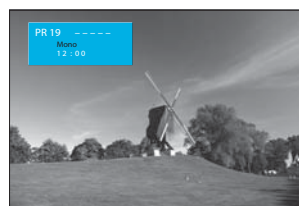
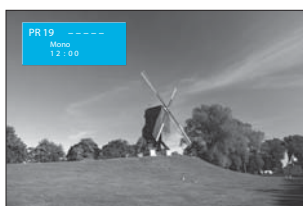

### 2. Adjustment of Bilingual sound.

- In bilingual broadcast reception, you can switch **Dual 1** to **Dual 2** by pressing the "□/○/||/|| (MTS)" button repeatedly.

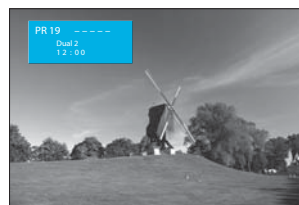

### Note :

- "□/○/||/|| (MTS)" only works in RF mode.

## Setup of Child Lock

### 1. Setup of Child Lock.

- Move to **Child Lock** in the **Utilities** menu.
- Select Child Lock to "On/Off" using the "◀LEFT/RIGHT▶" button.

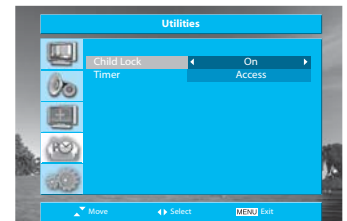
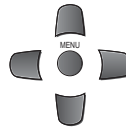

### Note :

- This prevents the use of the TV set without the remote control.
- If TV set is set up Child Lock,  $\text{⏻} / \text{⏻}$  LED will cycle through red/green for the ST-BY mode.
- If the Child Lock is "On", the set can only be switched back on using the remote control.

# Utilities

## Adjustment of Time

### 1. Setting the Clock.

- Move to **Timer** in the **Utilities** menu.
- To go to the Time, press the "**RIGHT**" button.
- Place the cursor to Hour / Minute with "**LEFT/RIGHT**" buttons.
- Set the Hour / Minute with the "**▲UP/DOWN▼**" buttons.
- Press the **Menu** button to initialize Time.

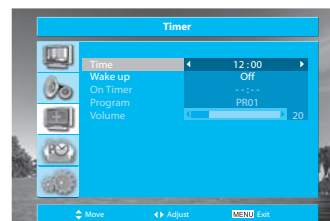
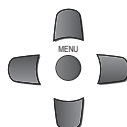

#### Note :

- The Time is clear when you turn the AC off, but if you select a program of your country which has Teletext or PDC transmission, the clock will be set and corrected automatically.

### 2. Setting the Wake up time / Program / Volume.

- Move to **Timer** in the **Utilities** menu.
- To go to the **Wake Up**, press the "**▲UP/DOWN▼**" buttons.
- Select the Wake Up to "**On**".
- Set **On Timer**, **Program** and **Volume** in a same way to the above for the Clock. The set will be turned on at selected time.

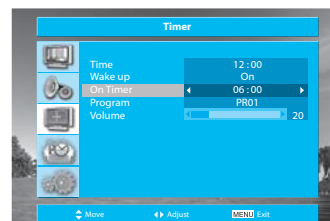
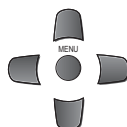

#### Note :

- Confirm the Time is set. The Wake up time is only available when the Time is set.
- If adjusted once, the On Timer continues to operate everyday unless canceling setup or turn the AC power off.
- It is a convenient method to wake you up in the morning

### 3. Set up of Off Time.

- By pressing the **SLEEP** button on the remote controller repeatedly, you can select one of the following settings:  
Sleep Timer: Off => 15 => 30 => 60 => 90 => 120 => Off
- The set will turn off after the time you select.

#### Note :

- If an active signal is not present for about 30 minutes, the set will automatically turn to Stand-by mode.



## Teletext

### SWITCHING TELETEXT ON/OFF

Press the **TELETEXT** button (  ).

The index page or the page viewed last will appear.

Repeatedly press the **TELETEXT** button the mode in the following order:

TV => TELETEXT => Double Window => TV

**Note** : Teletext works only in TV/AV mode.

### COLOUR BUTTONS IN TOP/FLOF TELETEXT

A red, green, yellow and blue field is shown at the bottom of the screen.

If TOP or FLOF Teletext is transmitted by the station, pressing the corresponding colour button **R, G, Y, B** on the remote controller, enables you to select the desired page easily.

### SELECTING PAGES

The **NUMBER** buttons are used to enter a page number.

The selected page number appears at the top of the screen and the page appears after a short time.

The "**▲UP/DOWN▼**" buttons increase or decrease the current page number by 1.

### INDEX PAGE

You can switch directly to the programme preview (with TOP text) or the overview page of the station you are currently viewing by pressing the **INDEX** button (  ).

### PAGE HOLD

Several sub pages can be combined under a page number and are scrolled at an interval determined by the television station. The presence of sub pages is indicated by, for example, 3/6 beneath the time, which means that you are looking at the 3rd page of a total of 6 pages.

If you want to look at a subpage for a longer period of time, press the **HOLD** button (  ).

The **HOLD** symbol appears and the contents of the subpage shown are kept on the screen and no longer updated or switched to other subpages. Pressing the **HOLD** button again, the current subpage appears.

### CALLING UP SUBPAGE DIRECTLY

Pressing the **SUBPAGE** button (  ), "0000" appears.

Enter the subpage number that you want to call up with the **NUMBER** button, for example, the 2nd page, sequence 0002.

The desired subpage will eventually be displayed on the screen and holds it there.

Meanwhile whilst you are waiting, it is possible to go back to the TV picture by pressing the **CANCEL** button (  ) on the remote and after a while, press the **CANCEL** button again to revert back to the saved Teletext sub page.

### WATCHING TV DURING TELETEXT MODE

Some pages are continually updated, for example, stock market reports, sports announcements, and the latest news.

If you want to watch television and stay informed at the same time, press the **CANCEL** button (  ).

The regular programme is still visible and the updated Teletext page number appears at the top of the screen.

Pressing the **CANCEL** button again, the Teletext page appears with the updated information.

### REVEAL ANSWER

This function can be used on certain pages to reveal the solution of riddles.

Press the **REVEAL** button (  ) to reveal a hidden answer and press again to hide it.

### DOUBLING CHARACTER SIZE

Repeatedly pressing the **SIZE** button (  ) doubles the character size in the following order:

**Upper half of the page => Lower half of the page => Normal size => Upper half of the page**

# Channel Banner (Digital)

## Channel Banner (Digital)

- The channel banner displays information about a channel number, name, broadcasting time, audio service and more. You can see this banner by pressing "OK/SELECT" button or "▲UP/DOWN▼" buttons on the Remote Control.

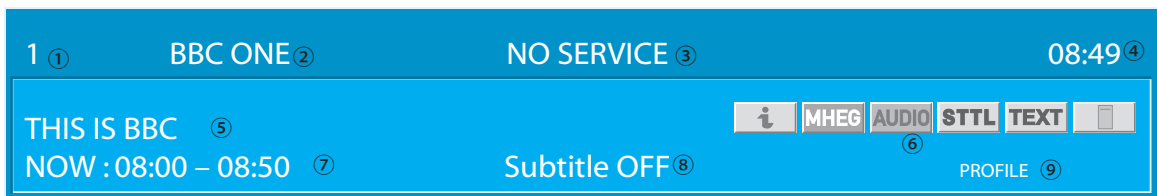

### 1. General Information.

- ① Channel number: Displays the current channel number.
- ② Channel name: Displays the current channel name.
- ③ Service available: Displays "NO SIGNAL" when no signal exists in the current channel or disconnect with signal input line. "NO SERVICE" when no program exists in the current channel, or "AUDIO SERVICE" when audio stream exists also. When scrambled stream appears, this displays "SCRAMBLED SERVICE".
- ④ Current time: Displays current time.
- ⑤ Program name: Displays the current program name.
- ⑥ Icon: Display the service items in the current program.

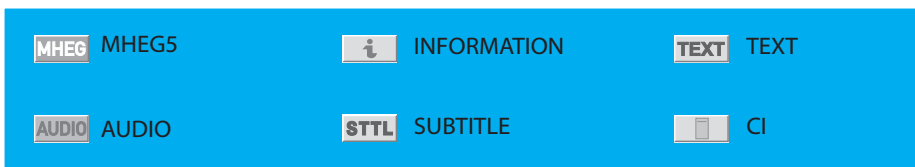

- ⑦ Program time: Display current / next program time (start ~ end).
- ⑧ Subtitle type: Displays the subtitle on/off.
- ⑨ Profile name: Displays the profile name if selected the user profile

# Channel Banner (Digital)

## 2. View the Channel Information.

- You can view information of all channels currently listed services.
- Press "▲UP/DOWN▼" buttons to preview the program information of the listed channels.
- Press "◀LEFT/RIGHT▶" buttons to display the now/next program information of the watching channel.
- Press "RECALL [Ⓞ]" button to display extended information on the current program. If channel has no information, RECALL [Ⓞ] button does not work.)

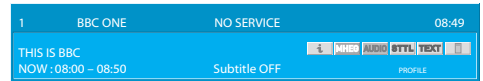

## 3. View the User Profile List.

- Press "YELLOW" multifunction button to start your own user profile list.
- Press "▲UP/DOWN▼" buttons to move the favourite list selected by user among the user profile list.
- Press "OK/SELECT" button to select the user profile list.

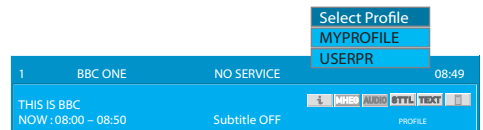

## 4. Select the Audio Language.

- Press "GREEN" multifunction button to start your own Audio Language.
- Press "▲UP/DOWN▼" buttons to move the Audio Language.
- Press "OK/SELECT" button to select the Audio Language.

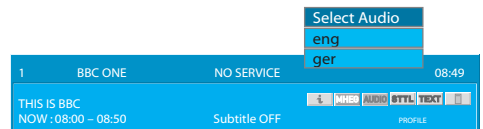

### Note :

The User Profile key (YELLOW) and Audio Language key (GREEN) are running if the Channel Banner is displayed on the screen. If the Channel Banner is closed on the screen, you can not select the User Profile or the Audio Language mode.

# Setting up DVB-T System

## Automatic Tuning of DVB

### 1. Press the "MENU" button to select the DVB-T Setup.

- Move the selection bar to the **DVB-T Setup** menu with "**▲UP/ DOWN▼**" buttons and press the "**▶RIGHT**" button.

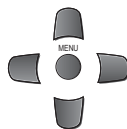

### 2. Select the "Auto Setup"

- Place the selection bar on **Auto Setup** and press the "**▶RIGHT**" button.

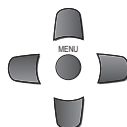

### 3. Please wait until the Tuning screen disappears.

- All available channels are searched automatically.
- You can see progress of Channel Tuning. (Pos, Quality, Progress...)

#### Note :

- If you start this menu, the saved channel list is lost. The new channel list is saved.
- If you press the **EXIT** key to stop auto setup, the channel list of channel list of channels found up till that time will be saved.

### DVB Auto Search

Pos.	Channel	Service name	Quality
1	23	heat	Poor
2	23	Mojo	Poor
3	23	Ttext Holidays	Poor
4	23	TCM	Poor
5	23	UK Style	Poor
6	23	Cartoon Nwk	Poor
7	23	Discovery	Poor

Searching... 0  50%

EXIT Back



# Setting up DVB-T System

## DVB-T Setup

The System menu shows you information as follows:

- Banner Display time, Subtitle Language, Audio Language.
- Common Interface, Signal Strength, Software Update.

### 1. Setting Banner Display Time.

- Move to **System** in the **DVB-T Setup**.
- To go to the Banner Display Time, press the "**RIGHT▶**" button.
- Position a selection bar to Banner Display Time.
- Press the "**◀LEFT/RIGHT▶**" buttons to select the display time:  
3 seconds => 5 seconds => 10 seconds
- You must press the "**OK/SELECT**" button to store display time.

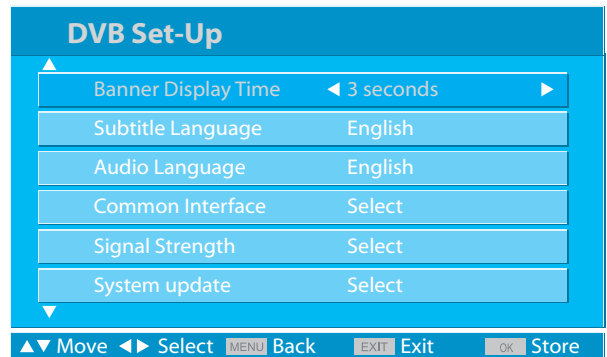

### 2. Select Subtitle Language.

- Move to **Subtitle Language** in the **System**.
- Press the "**◀LEFT/RIGHT▶**" buttons to select the Subtitle Language:  
English => Welsh => Gaelic
- You must press the "**OK/SELECT**" button to store the Subtitle Language.

**Note :** If DVB signal has no Welsh, Gaelic information, default language is English regardless of selection.

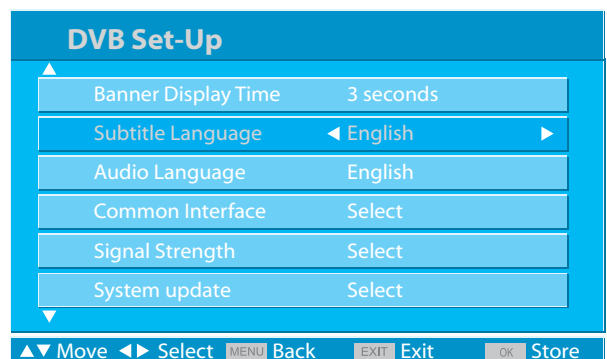

### 3. Select Audio Language.

- Move to **Audio Language** in the **System**.
- Press the "**◀LEFT/RIGHT▶**" buttons to select the Audio Language:  
English => Welsh => Gaelic
- You must press the "**OK/SELECT**" button to store the Audio Language.

**Note :** If DVB signal has no Welsh, Gaelic information, default language is English regardless of section.



# Setting up DVB-T System

## 4. Common Interface.

- Place the selection bar on **Common Interface** and press the "RIGHT▶" button.
- The Common Interface menu provides the Information of CI card inserted into the CI slot, at the left side of the TV. See page 54.

### Note :

- If no CI card is inserted the Message "No CI Module" will be displayed. If you have inserted a CI card, check that it is fully inserted.



## 5. Signal Strength.

- Place the selection bar on **Signal Strength** and press the "RIGHT▶" button.
- The **Signal Strength** function displays an indication of signal quality and Strength for each DVB Programme position.

### Important :

- The DVB System requires a good quality signal to provide the best picture. For the DVB system, interference such as this can disrupt the flow of data causing the picture to appear to be made up of large blocks or to freeze intermittently.
- If the picture disappears completely, this could mean that signal quality is very poor. If this happen often, you may need to improve your aerial system to provide a better signal.

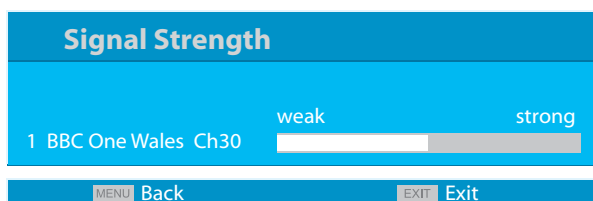

## 6. Over Air Download to System Update.

- You can check the current software version by selecting the Software Update menu and if new version is available, you can upgrade your own software.
- Move to **Software Update** in the **System** and press the "RIGHT▶" button.
- A Software update menu will show the current OAD status.
- If a new software version has been found, this menu will inform the user that a new version of software is ready to be downloaded. If the "OK/SELECT" button is pressed, the downloading will start.

### Note :

- If your TV informs you there is a new software update, the TV menu will help you update the software using DVB-T air signal.
- Downloading will take a few minutes to complete, so check first that there are no imminent programmes that you wish to watch
- You must not switch off the TV while downloading is in progress, as errors could occur.
- If no new software version is found, this menu will display the current software version and inform the user that this is up-to-date.

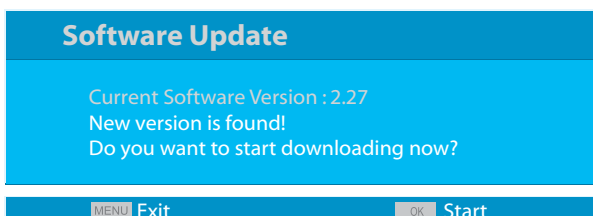

# Setting up DVB-T System

**Note :**

- The whole downloading process may take about 10~15 minutes according to signal status.

## Software Update

Downloading .... Please wait!

0  100%

MENU Back

- If you want to start the installation press the "OK/SELECT" button to start.

## Software Update

Downloading is completed!  
Do you want to start the installation?

MENU Back

OK Start

**WARNING :**

- During the installation process don't power off TV.

## Software Update

WARNING !  
Writing To Flash, Don't Power Off TV  
It takes about 2 minutes.

**Note :**

- Burning time is about 2~3 minutes.

## Software Update

Software update is completed!  
Please restart your TV.

EXIT Exit

- When the OAD process has finished, please restart your TV using your remote controller or main power SW in front of TV set.

# Electronic Program Guide (EPG)

- The DTV Electronic Program Guide(EPG) displays program information about each channel, up to seven days ahead.
- You can edit your own profiles, and record programs.
- By pressing the **"GUIDE"** button to access EPG directly, you can see all channels broadcasting now.



## Note :

- The Program Guide is only available when watching DVB channels.

### 1. Select a desired channel.

- Select a channel with the **"▲UP/DOWN▼"** buttons.
- Press the **"OK/SELECT"** button

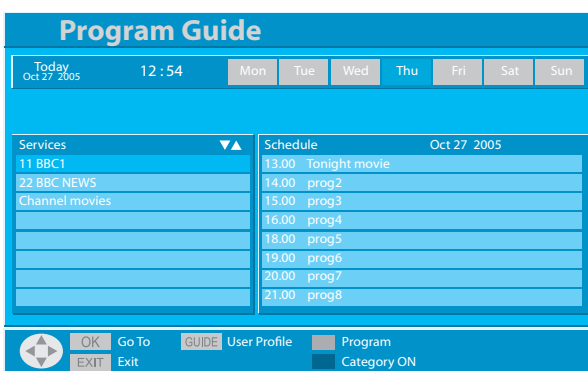

### 2. Program Select.

- Press the **"RED"** multi function button to move the highlighted cursor bar to the Schedule section.
- Select a program with the **"▲UP/DOWN▼"** buttons.
- Press the **"GREEN"** multi function button to display the information of the highlighted program.

## Note :

- Press the **"GREEN"** button again to return the program section.
- Press the **"RED"** multi function button to move the highlighted cursor bar to the Channels section.

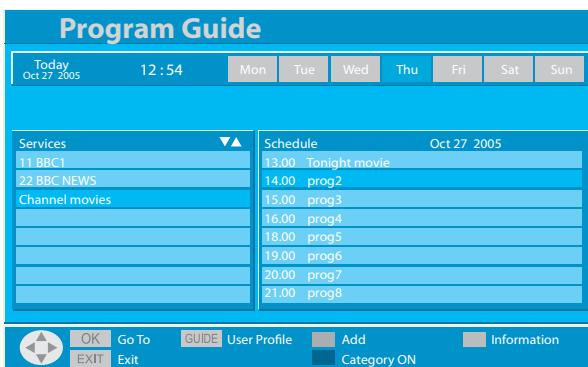

# Electronic Program Guide (EPG)

### 3. Category / Theme Select.

- Press the **"BLUE"** multi function button to display the Category list.
- Press the **"YELLOW"** multi function button to change the Category/Theme list.
- Press **"◀LEFT/RIGHT▶"** buttons to select the Category/Theme.
- Press **"OK/SELECT"** button to sort the channel
- For information of the each program, press the **"RED"** multi function button and select the program with the **"▲UP/DOWN▼"** buttons, press **"GREEN"** multi function button to display the information.

**Note :** If you select the 'NEWS', Program Guide displays the news channels on the Service section.

### 4. Day Select.

- Press **"◀LEFT/RIGHT▶"** buttons to see the information of the selected day.

**Note :** Our TV can support 7-DAY EPG. But not all channels support 7-DAY EPG and some only have NOW and NEXT program.

### 5. Edit your own Channel list (User Profiles).

- Press the **"GUIDE"** button to edit the user profile from DTV EPG.
- Profile spell can be changed using the **number** button.
- You can add a profile with **"RED"** multi function button.

**Note :** You can edit your own channel list on your TV set. (see page 57)

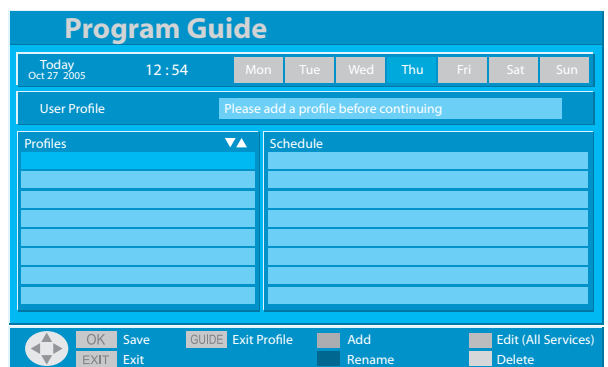
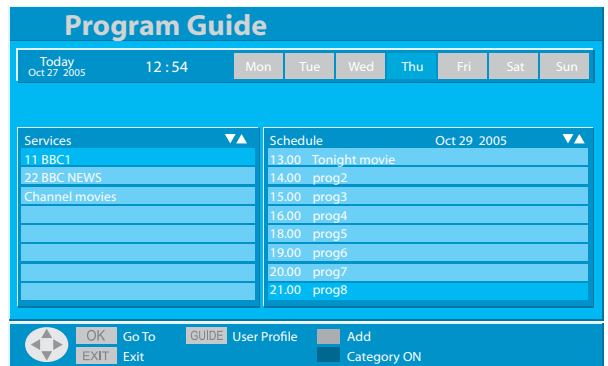
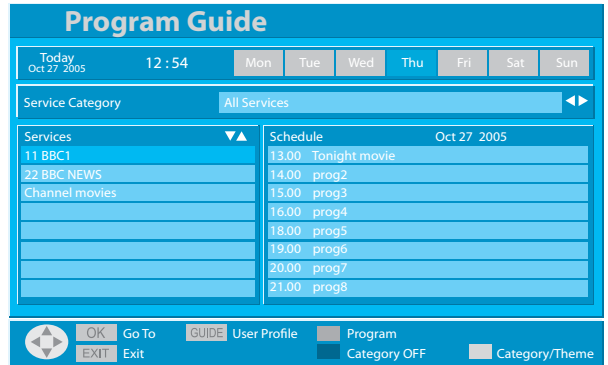

# Common Interface Module Menu

- The Common Interface menu allows you to access a pay-per-view (PPV) service on your TV set. This feature operates once you have obtained a CI module and a viewing card. If you want to know the pay-per-view (PPV) service in your region, please contact your nearest PPV provider for detail.

## Note :

- Switch off the TV using the power button before inserting or removing a module.
- If you are installing a TV software update, please follow the dedicated instructions supplied with the module.
- Insert the CI module as described below:
- Some Common Interface Modules may be a two piece design consisting of a card reader together with the viewing card.

## 1. Setting CI Card.

- When using the design card, first insert the card reader firmly into the CI slot on the TV.
- Insert the viewing card into the reader.
- Switching on the TV
- Press the "MENU" button and move to the **DVB-T SET-UP** Menu with the "▲UP/DOWN▼" buttons.
- Access the System Menu with the "◀LEFT/RIGHT▶" buttons and move and access to the Common Interface Menu with the "▲UP/DOWN▼" buttons.
- If you have inserted a CI Module, Check that it is fully inserted and the CI module name will be displayed.

**Note :** If no module is inserted the message "Slot 1 : No CI Module" will be displayed.

## 2. CI Main Menu.

- Press the "MENU" button to call up the menu.
- Move the selection bar to the **DVB-T Setup** menu with "▲UP/DOWN▼" buttons.
- Press the "RIGHT▶" button.
- Place the selection bar on Common Interface Menu and press the "RIGHT▶" button.
- You can see all available CI Information.

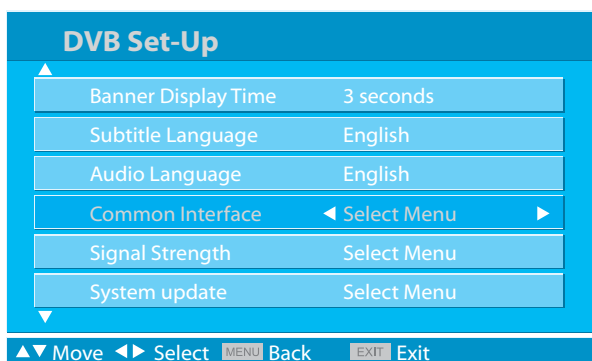

# Common Interface Module Menu

### 3. Module Information.

- You can see information of CI Module.
- Serial number, SAP number, Manufacturer, SW version, FW version.

CI - Module Information	
Serial Number:	11410520101045
SAP Number:	904244R10
Manufacturer:	SCM Systems
SW version:	Top Up TV 1.03.002
FW version:	1.04.03

▲▼ Move ◀▶ Select MENU Back EXIT Exit

### 4. Smart Card Information.

- This Feature displays the serial number and a term of validity of the module.

CI - Smart Card Information	
Top Up TV	22/12/2004 (d/m/y)

▲▼ Move ◀▶ Select MENU Back EXIT Exit

### 5. Software Download.

- You can upgrade your own Software.
- If you selected "YES" with "▲UP/DOWN▼" buttons, start the software download.

**Note :** The features that now appear on screen are dependent on the contents of the selected Common Interface Module.

Software Update	
Do you want to upgrade your module?	
Yes	
No	

▲▼ Move ◀▶ Select MENU Back EXIT Exit

# Digital Teletext (MHEG5)

- Many broadcasters provide a Digital Teletext service in form of a dedicated Teletext channel. When you switch to a Digital Teletext service, the image you see can contain graphics and text, laid out and controlled in a manner decided by the broadcaster.
- In all cases, it is possible to navigate the pages using buttons on the remote control, but because the commands available must apply to all manufacturers of DVB-T equipment. Most of the Digital Teletext services currently available use simple navigation methods based on the following buttons.

## 1. Press the "RED" multi function button to load the Digital Teletext service.

**Note :** The start button to start MHEG5 depends on the broadcasts own. For example, BBC station allocated **RED** multi function button to start MHEG5, but ITV allocated **TEXT** button.

## 2. Press the "◀LEFT/RIGHT▶"; "▲UP/DOWN▼" buttons to navigate the services.

## 3. Press the multi function buttons to operate the function.

## 4. If you want to exit the Digital Teletext Service, press the "TEXT" button or "EXIT" button.

## 5. Press the "▲UP/DOWN▼" buttons to select other channels.



### Note :

- As soon as you switch to a DVB channel with links to a Digital Teletext service, Software is downloaded in the background to enable the Digital Teletext function. This means that when switching to a DVB channel, you should wait for approximately 5 seconds before pressing the "TEXT" button – this will allow the software to download. If you press the "TEXT" button before download is complete, there will be a short delay before the text screen is displayed.



# User Profile

- This feature allows you to edit your own profiles on your TV set. You can edit your favorite channels on the Program Guide.
- You can add up 3 user profiles. Before starting the user profile menu, you must operate Program Guide.

## 1. Press "GUIDE" button to move the user profile menu.

- Before starting the user profile menu, you must operate Program Guide.
- The messages 'User Profile' and 'Please add a profile before continuing.' will be displayed if no user profile added.

## 2. Press "RED" multi function button to add a new profile.

- Press number keys to rename the profile and press "OK/SELECT" button to save the profile name.

## 3. Press "GREEN" multi function button to edit the selected profile.

- Press the "▲UP/DOWN▼" buttons to select the service.
- Press the "◀LEFT" button to assign the favorite channel banner. (Press the "◀LEFT" button again to cancel the favorite channel banner.)
- Press the "▶RIGHT" button to skip the selected channel. (Press the "▶RIGHT" button again to cancel the skipped channel.)

## 4. Press "YELLOW" multi function button to delete the selected profile.

- Press "OK/SELECT" button to delete the selected profile.

## 5. Press "BLUE" multi function button to edit the service order of selected user profile.

- Press the "▲UP/DOWN▼" buttons to move the service.
- Press the "◀LEFT" button to select the service. (Press the "▶RIGHT" button to deselect)
- Press the "▲UP/DOWN▼" buttons to move the selected channel to your preferred location.
- Press the "◀LEFT" button to assign the service to a new location.
- Press the "OK/SELECT" button to save the selected profile and press "BLUE" multi function button again to exit the service order.

## 6. You can see your favourite channels on the channel banner.



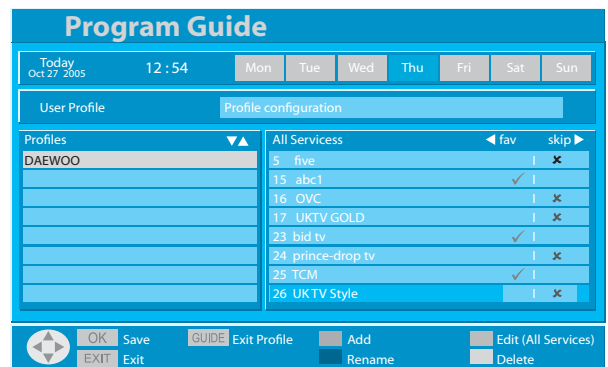
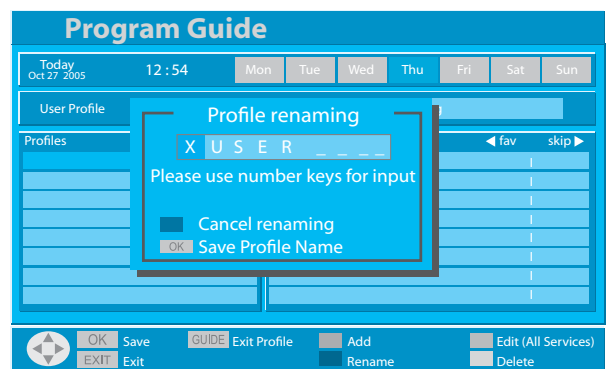
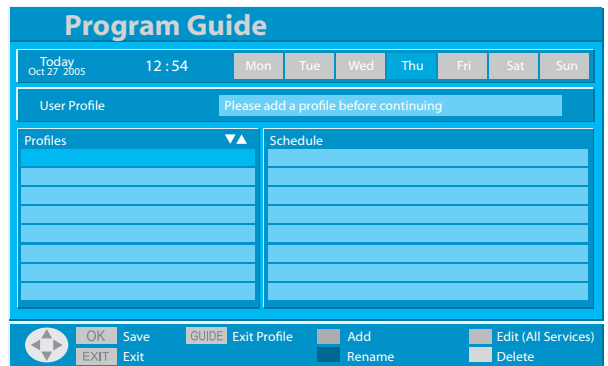



- See page 47 to select your own profile list.
- Press the "▲UP/DOWN▼" buttons to view information of the selected favourite channels.
- Press the "RECALL [ⓘ]" button to view.
- Press the "OK/SELECT" button to move the selected channel (if you don't press any button, channel banner closed).



# Troubleshooting

## Symptoms and Solutions

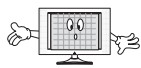
Please check the following items before asking for repair service.

Symptom	Check items
Neither picture nor sound 	<ul style="list-style-type: none"> <li>- Check the contact of sockets is all right.</li> <li>- Check the TV main power is on.</li> </ul>
Picture is OK but no sound 	<ul style="list-style-type: none"> <li>- Check the Volume control is set to minimum or mute.</li> </ul>
Sound is OK, but no colour. 	<ul style="list-style-type: none"> <li>- Check the colour control and adjust it properly.</li> <li>- Check the program is in colour and not in black &amp; white.</li> </ul>
The picture has image. 	<ul style="list-style-type: none"> <li>- Check the antenna is installed correctly and if not, adjust the overlapped antenna toward the broadcasting station.</li> </ul>
Picture has "snow noise" 	<ul style="list-style-type: none"> <li>- Check the antenna or its connection is correct and if not, correct the antenna fault or connection cable fault.</li> <li>- Check if car traffic or neon sign disturbs the sound effect.</li> </ul>
Stripes on picture. 	<ul style="list-style-type: none"> <li>- Check the susceptible interference by other electronic devices such as radio and television and keep magnetic or electronic devices away from the TV.</li> </ul>
Bad stereo or Dual sound. 	<ul style="list-style-type: none"> <li>- Long distance from the station or other radio waves can generate bad sound reception. If so, change the mode to Mono.</li> </ul>
Remote control does not work. 	<ul style="list-style-type: none"> <li>- Check if the batteries in the Remote control are dead.</li> <li>- Check if any object between IR sensor of the TV and the Remote control does not obstruct.</li> </ul>



# Troubleshooting

## In DVB-T mode

Some Problems will only occur when viewing DVB channels.



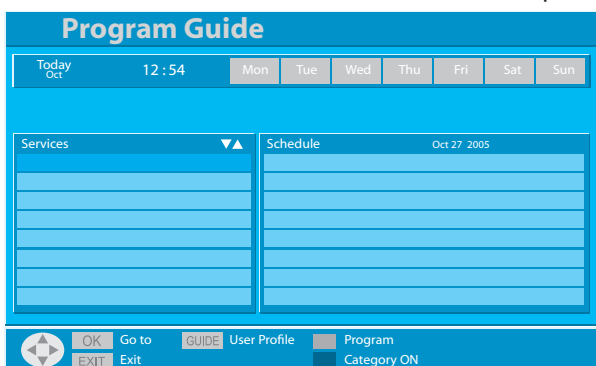

Due to the different techniques involved in digital reception, DVB signal quality can be poor even if you appear to have a strong signal when viewing analogue programmes.

The DVB system requires a good quality signal to provide the best picture. When viewing analogue pictures, interference such as signal reflection from nearby buildings or mountains causes 'ghosting', but still provides a viewable picture. For the DVB system, Interference such as this can disrupt the flow of data causing the picture to appear to be made up of large blocks, or to freeze intermittently. If the picture disappears completely, this could mean that signal quality is very poor. If this happens often, you may need to improve your aerial system to provide a better signal. This TV contains a complex microprocessor which enables you to view enhanced digital services. Occasionally this device may need to be reset. This can be done by pressing the stand-by button on your remote control or the power switch on the front panel.

SYMPTOM	CHECKS
<p>No DVB Channels listed in the TV Guide after Auto Setup.</p> 	<p>Check that DVB transmissions are available from the transmitter you are currently using. If not, try directing the aerial at another local transmitter.</p> <p>Check analogue transmissions. If picture quality is poor, you will need to improve or change your aerial system to receive DVB channels. Consult a local installer.</p>
<p>Blocky interference. Picture freezes intermittently.</p> 	<p>Blocky interference indicates that the signal quality is poor. You should consider improving your aerial system.</p> <p>To check the quality of your signal use the Signal Quality feature (See page 50)</p>

# Troubleshooting

## In PC mode

Symptom	Check items
<p>"OUT OF RANGE" appears on the screen</p> 	<ul style="list-style-type: none"> <li>- Check the resolution and frequency of your PC. Then, adjust them to optimum condition for LCD TV.</li> <li>- Refer to the table of PC mode input format (If registered resolution and frequency on the table no listed then no picture will be displayed.)</li> </ul>
<p>"NO SIGNAL" appears on the screen.</p> 	<ul style="list-style-type: none"> <li>- Ensure that the signal cable is firmly connected to PC and TV.</li> </ul>
<p>Image is not clear.</p> 	<ul style="list-style-type: none"> <li>- Adjust the PHASE control.</li> </ul>
<p>Image is not centered.</p> 	<ul style="list-style-type: none"> <li>- Adjust the H-POSITION and V-POSITION control.</li> </ul>

### • AFTER SALES SERVICE

Do not hesitate to contact your retailer or service agent if a change in the performance of your product indicates that a faulty condition may be present.

## Standard of Product

Model	Features	DLT-26C2	DLT-32C2
<b>LCD Panel</b>	Screen Size	26"	32"
	Aspect Ratio	16:9	16:9
	Resolution	1366 x 768(WXGA)	1366 x 768 (WXGA)
	Pixel Pitch	0.4215 mm	0.51075 mm
	Contrast Ratio	1000 : 1	800 : 1
<b>TV System</b>	Receiving System	PAL-I, B/G, D/K, SECAM-B/G, D/K, DVB-T	
	Stereo System	2-Carrer/NICAM	
<b>Power Consumption</b>	Max.	130W	150W
	Power Source	100-240V, 50-60Hz	100-240V, 50-60Hz
<b>Dimension (W x H x D)</b>	Set Dimension	812x502.7(456.7)x240(112)	944 x 575(529) x 240(115)

Model	Features	DLT-26C3	DLT-32C1/DLT-32C3
<b>LCD Panel</b>	Screen Size	26"	32"
	Aspect Ratio	16:9	16:9
	Resolution	1366 x 768(WXGA)	1366 x 768 (WXGA)
	Pixel Pitch	0.4215 mm	0.51075 mm
	Contrast Ratio	1000 : 1	800 : 1
<b>TV System</b>	Receiving System	PAL-I, B/G, D/K, SECAM-B/G, D/K, DVB-T	
	Stereo System	2-Carrer/NICAM	
<b>Power Consumption</b>	Max.	130W	150W
	Power Source	100-240V, 50-60Hz	100-240V, 50-60Hz
<b>Dimension (W x H x D)</b>	Set Dimension	674 x 550(496) x 240(114)	806 x 628.5(574.5) x 240(114)

Model	Features	DLT-37C3	DLT-37C3
<b>LCD Panel</b>	Screen Size	37" (LPL)	37" (AUO)
	Aspect Ratio	16:9	16:9
	Resolution	1366 x 768(WXGA)	1366 x 768 (WXGA)
	Pixel Pitch	0.200 x 0.600 mm	0.600 x 0.600 mm
	Contrast Ratio	800 : 1	1200 : 1
<b>TV System</b>	Receiving System	PAL-I, B/G, D/K, SECAM-B/G, D/K, DVB-T	
	Stereo System	2-Carrer/NICAM	
<b>Power Consumption</b>	Max.	160W	190W
	Power Source	100-240V, 50-60Hz	100-240V, 50-60Hz
<b>Dimension (W x H x D)</b>	Set Dimension	940 x 720(655) x 328.5(129)	944 x 720(655) x 328.5(129)

※ In Dimension, the size in the brackets is set dimension without stand.  
Owing to our policy of continuous improvement, specifications may change.

## Free Manuals Download Website

<http://myh66.com>

<http://usermanuals.us>

<http://www.somanuals.com>

<http://www.4manuals.cc>

<http://www.manual-lib.com>

<http://www.404manual.com>

<http://www.luxmanual.com>

<http://aubethermostatmanual.com>

Golf course search by state

<http://golfingnear.com>

Email search by domain

<http://emailbydomain.com>

Auto manuals search

<http://auto.somanuals.com>

TV manuals search

<http://tv.somanuals.com>