

**DAEWOO**   
ELECTRONICS

## **NO-Frost Combi-Refrigerator**

**RF-421N..**  
**RN-421N..**

**RF-422N..**  
**RN-422N..**



Code : MRP3423-11



### SAFETY WARNING (R-600a Models Only)

This appliance contains a certain amount of isobutane refrigerant (R600a) a natural gas with high environmental compatibility that is, however, also combustible. when transporting and installing the appliance, care should be taken to ensure that no parts of the refrigerating circuit are damaged.

Refrigerant squirting out of the pipes could ignite or cause an eye injury. If a leak is detected, avoid any naked flames or potential sources of ignition and air the room in which appliance is standing for several minutes.

- In order to avoid the creation of a flammable gas-air mixture if a leak in the refrigerating circuit occurs, the size of the room in which the appliance may be sited depends on the amount of refrigerant used.

The room must be 1m<sup>3</sup> in size for every 8g of R600a refrigerant inside the appliance. The amount of refrigerant is shown on the identification plate inside the appliance.

- Never start up an appliance showing any signs of damage. If in doubt, consult your dealer.



### RoHS (Directive 2002/95/EC) Compliant

This product is environmentally sound and sustainable free from Pb, Cd, Cr+6, Hg, PBBs and PBDEs restricted in accordance with the Directive.

### Refrigerant Information(RF-421/422.. Models Only)

Refrigerant	R-134a
Charge	0.095kg
Global Warming Potential	1300
Contains fluorinated greenhouse gases covered by the Kyoto Protocol and is hermetically sealed.	

# WARNING / SAFETY PRECAUTIONS

To avoid any risk of personal injury, material damage or incorrect use of the appliance, be sure to observe the following safety precautions. (After reading these owner's instructions, please keep them in a safe place for reference). Remember to hand them over to any subsequent owner.



**WARNING**

Indicates that a danger of death or serious injury exists



**CAUTION**

Indicates that risk of personal injury or material damage exists



## WARNING

**Do not plug several appliances into the same sockets.**

- This could cause overheating and the risk of fire.

**Keep the power plug away from the rear of the fridge / freezer.**

- A damaged power plug may cause fire due to overheating.

**Do not directly spray water inside or outside the fridge / freezer.**

- There is a risk of fire or electric shock.

**Do not spray water inside or outside the fridge / freezer.**

- There is a risk of explosion or fire.

**Do not bend the power cord excessively or place heavy articles on it.**

- This constitutes a fire hazard. If the power cord is damaged, have it replaced immediately by the manufacturer, its service agent or a similarly qualified person.

**Do not insert the power plug with wet hands.**

- You may receive an electric shock.

**Do not put a container filled with water on top of the appliance.**

- If the water spills on to any electrical parts, it may lead to fire or electric shock.

**Do not install the fridge / freezer in a damp place, where it could be splashed with water.**

- Incorrect insulation of the electrical parts may cause an electric shock or fire.

**Do not store volatile and flammable substances in the refrigerator.**

- The storage of benzene, thinner, alcohol, ether, LP gas or other such substances may cause an explosion.

**Do not disassemble, repair or alter the appliance.**

- It may cause fire or abnormal operations, which may lead to injury.

Pull the power plug out of the socket before replacing the interior light in the refrigerator.

- Otherwise, there is a risk of electric shock.
- Only the customer service may change the power cord and carry out any other repairs. Improper Installations and repairs may put the user at considerable risk.

**Be sure to earth the appliance.**

- Otherwise, it may cause material damage and electric shock.

**If you wish to dispose of the fridge / freezer, throw it away after removing the door or its seals.**

- In this way, it is not possible for a child to remain trapped inside it.

**Keep ventilation openings in the appliance enclosure or in the built-in structure, clear of obstruction.**

**Do not use mechanical devices or other means to accelerate the defrosting process, other than those recommended by the manufacturer.**

**Do not damage the refrigerant circuit.**

**Do not use electrical appliances inside the food storage compartments of the appliance, unless they are of a type recommended by the manufacturer.**



## Caution

### Do not store too much food in the appliance.

- When you open the door, an item may fall out and cause personal injury or material damage.

### Do not put bottles or any kind of glass in the freezer.

- The container may break and cause personal injury.

### If the wall socket is loose, do not insert the power plug.

- It may cause electric shock or fire.

### Do not disconnect the power cord by pulling on it.

- You may disconnect a wire and cause a short circuit.

### Do not store article on top of the appliance.

- When you open or close the door, the articles may fall and cause personal injury or material damage.

### Do not store pharmaceutical products, scientific material or other temperature-sensitive products in the refrigerator.

- Products that require strict temperature controls must not be stored in the refrigerator.

### Do not let a child hang from the door.

### Do not touch any containers and food in the freezer with wet hands.

- It may cause frostbite.

### Remove any foreign matter from the power plug pins.

- Otherwise, there is a risk of fire.

### Do not insert your hand into the bottom area of appliance.

- Any sharp edges may cause personal injury.

### After unplugging the appliance, wait for at least five minutes before plugging it again to the wall socket.

- Abnormal operation of the freezer may cause material damage.

### If the appliance is not be used for a long period of time, pull out the power plug.

- Any deterioration in the insulation may cause fire.

### Do not let children touch or play with the control panel on the front of the appliance.

- Do not allow children to play with this appliance.
- Do not stand or lean on the base panel, pull-out parts, door and so on.
- Repairs and maintenance of the appliance should only be performed by a qualified technician. Incorrect repairs by an unqualified person are a potential source of danger that may have critical consequences for the user of the appliance.
- Never put ice cubes or ice lollies straight from the freezer into your mouth.  
(The low temperature may cause "cold burns".)



## Caution

The refrigerant used in fridge / freezers and the gases in the insulation material require special disposal procedures.

Ensure that none of the pipes on the back appliance are damaged prior to disposal.

# DISPOSAL

## Installing The Fridge / Freezer

- 1. Allow an adequate space and install the fridge/freezer on a firm, level floor.**
  - If the appliance is not level, there may be unusual noises and poor cooling.
- 2. Clean the fridge / Freezer**
  - Wipe and clean the inside and outside of appliance with a damp cloth.
- 3. Plug the fridge / freezer into a wall socket used exclusively by this appliance.**
  - This appliance must be properly earthed.
- 4. Place the food in the fridge / freezer.**
  - It is recommended that you wait for the appliance to cool for 3~4 hours before storing food in it.
- 5. Keep 60mm of space between the refrigerator and the back wall.**
  - Insufficient space causes the noise of vibration, weakening of refrigerating power and the waste of electricity.
  - Overall space required in use.  
Refer to drawing and dimension as below.

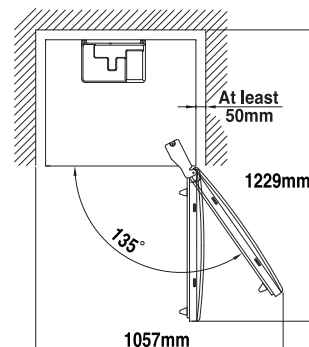

- 6. The electrical plug must be accessible without moving the set.**
- 7. For ambient temperature below 10 °C, the perfect performance of our refrigerator can not be achieved.**



## Caution

### Use of an earthed socket exclusively

#### For the appliance :

- If you are using a socket with an earthed terminal, you do not require a separate earthed connection.

#### Use of a non-earthed socket :

- Connect the “earthed wire” to the steel plate and bury it at depth of at least 25cm in the ground.

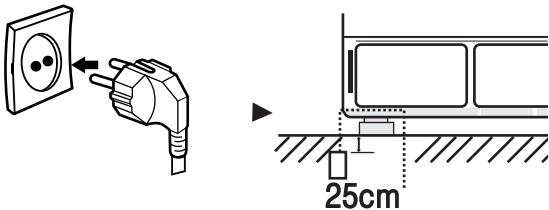

## LEVELING

If the front of the appliance is slightly higher than the rear, the door can be opened and closed more easily.

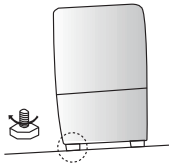
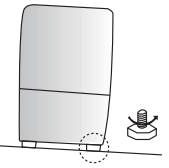
<p><b>1. The appliance tilts down to the left.</b> Turn the left adjusting leg in the direction of the arrow until the appliance is level.</p>	
<p><b>2. The appliance tilts down to the right.</b> Turn the right adjusting leg in the direction of the arrow until the appliance is level.</p>	

## Preparing The Fridge / Freezer

To Prepare your appliance for use and check that it is running correctly, take the following steps.

1. Install removed all shelves and compartments during transport in the correct positions.
2. Clean the fridge / freezer and accessories to remove any dust that accumulated during packing and shipping.
3. The interior light should be turned on when the refrigerator door's opened
4. Set the temperature control to the coldest temperature and let the refrigerator operate for one hour.  
The freezer should get slightly chilled and the motor should run smoothly with a soft hum and no noise.  
Your fridge / freezer is operated by a compressor which switches “on and off” to maintain the internal temperature. When compressor is new, it requires running in for a period of up to five months.  
During this period, it may be slightly noisy. This is quite normal and does not represent a fault.
5. Store food once the temperature in the refrigerator is sufficiently low. It takes a few hours after starting the refrigerator to reach the proper temperature.  
If the appliance does not operate correctly, check the electricity supply.  
If the problem persists, contact your dealer.

## CE

This product has been designed, constructed and marketed in accordance with EEC directives 2006/95/CE, 2004/108/CE, and 96/57

Please read this manual carefully to ensure maximum satisfaction from your appliance. Keep the manual in a safe place for future reference.  
For drawings referenced in the text below, see flap at back of the manual.

## ABOUT THIS PRODUCT

- This is designed for domestic household use only.
- Use the 4-star freezer compartment
  - to freeze fresh and cooked foods,
  - to store deep-frozen and frozen product,
  - to make ice-cubes.
- Use the refrigerator compartment
  - to store fresh foods,
  - to cool drinks.
- The freezer and refrigerator compartment defrost automatically.
- Owing to cool air circulation (multi-airflow system) an even temperature is maintained on every shelf of the refrigerator compartment.
- The electronic control panel or control knob enable you to control the temperature of refrigerator compartment.

## BEFORE CONNECTING TO THE MAINS

1. Wait 2 hours after delivery before you connect the appliance to the power supply, in order to ensure trouble-free operation.
2. Check the product label which locates refrigerator compartment wall for voltage, refrigerant and other information.
3. The socket should be easily accessible and not directly behind the appliance.
4. Electrical connections must be made in accordance with local regulations. The appliance must be earthed as described by law (connected through a properly earthed plug and socket). The manufacturer rejects all liability for injury to persons and animals or damage to property resulting from failure to comply with this requirement.
5. A 10A fuse or one of higher value must be used in the socket circuit.
6. If the appliance plug and the wall socket are incompatible, the socket must be replaced by a qualified electrician.
7. If the supply cord is damaged, it must be replaced by the manufacturer, his service agent or a similarly qualified person.
8. Do not use extension leads or multiple adapters, etc

# DESCRIPTION OF YOUR REFRIGERATOR

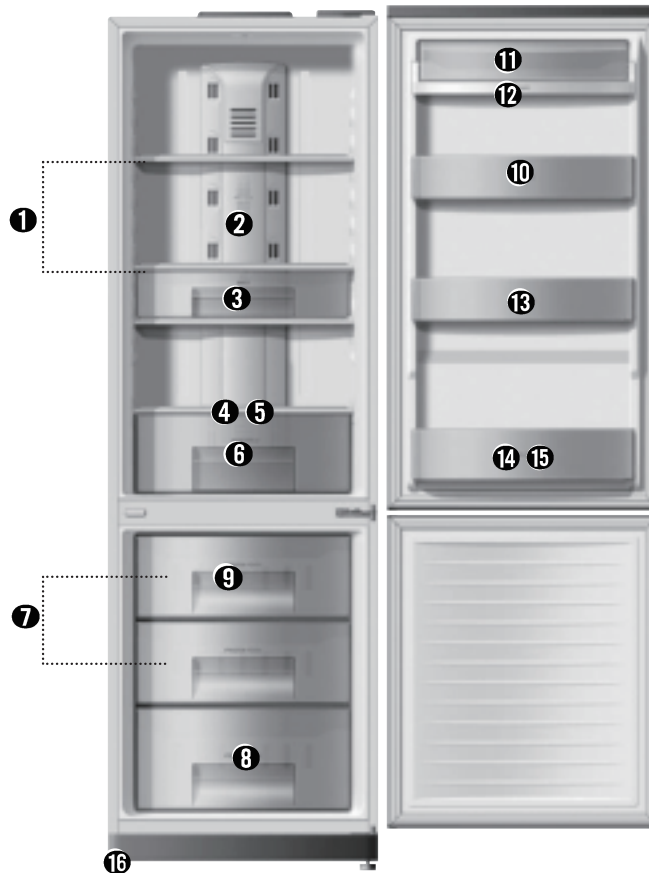

**1** Shelves

**2** Multi duct

**3** Basket Multiple(option)

**4** Shelf of vegetable case

**5** Knob humidity

**6** Vegetable case

**7** Case F "B" (2EA)

**8** Case F "C"

**9** Case icing

**10** Case egg tray

**11** Cover dairy

**12** Dairy pocket

**13** Bottle pocket

**14** Guide bottle pocket

**15** Jumbo pocket

**16** Adjustable foot

# Name of Each Part & Function

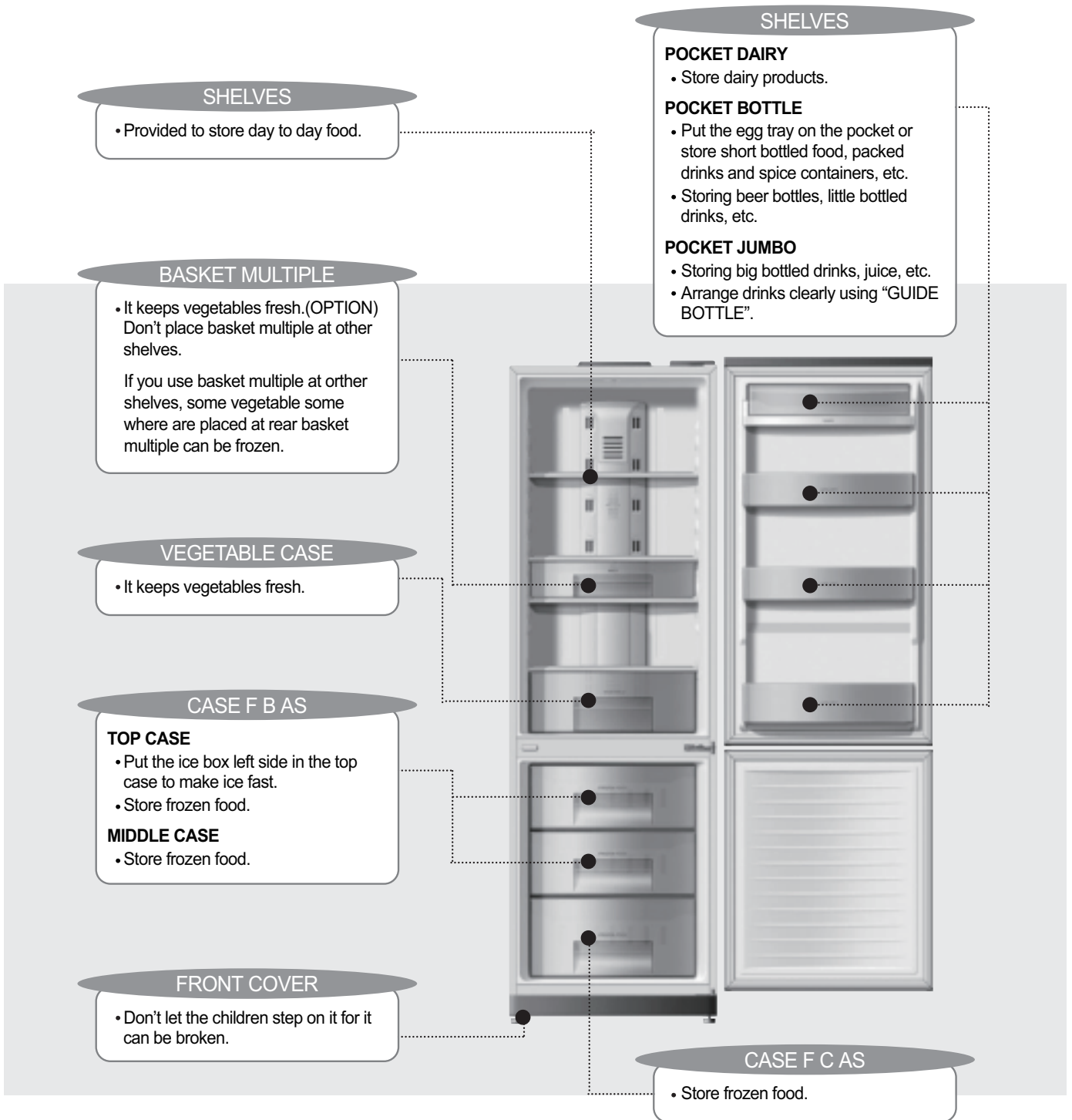



## DISCONNECTION

Note: does not apply in the UK.

Electrical disconnection : remove the plug from the mains, or (if applicable) disconnect the two-pole circuit breaker upstream from the socket.

## PROTECTING THE ENVIRONMENT

- The packaging may be completely recycled, as confirmed by the recycling symbol; follow local disposal regulations.
- The appliance is manufactured from reusable materials.
- When you decide to scrap this product, please check the cable to be disconnected from the mains. Then cut off the cable and dispose of the product according to local waste disposal laws.
- This product is free of CFC's (cooling circuit contains R134a or R-600a). This use R-600a or R134a as a refrigerant. Check the compressor label on the rear of the appliance or the rating label inside the fridge to see which refrigerant is used for your refrigerator.

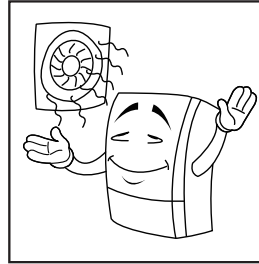

Keep room dry and well ventilated.

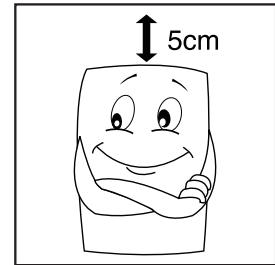

Keep more than 5cm distance space at the top for ventilation.

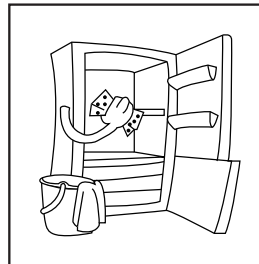

Clean interior with a damp cloth.

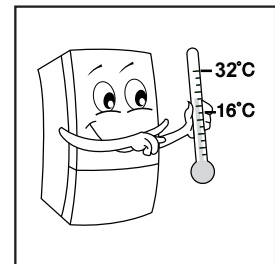

Best room temperature Range +16 °C to 32 °C

## IMPORTANT

1. Although this product was carefully checked before packing. Please check the product for damage and for correct closing of the doors. Complaints must be reported to your retailer within 24 hours of delivery.
2. Installation instructions (7 drawings below)
3. Keep potentially hazardous packing materials (plastic bags, etc.) out of reach of children to prevent the risk of trapping and suffocation.

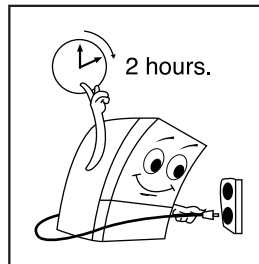

- Wait 2 hours before connecting to the mains

## GENERAL RECOMMENDATION

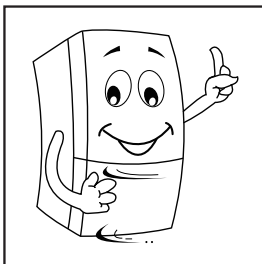

Check for damages and correct closing of the doors.

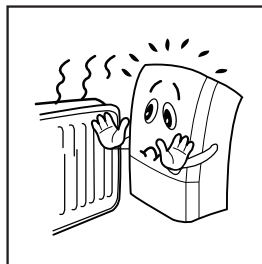

Not in the vicinity of a heat source.

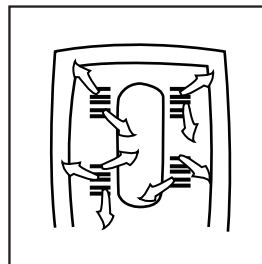

Keep air vents open.

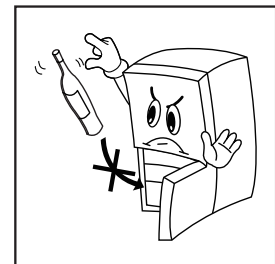

No glass bottles in the freezer compartments. The bottles might burst.



Ice cubes and ice lollies straight out of the freezer are too cold for consuming. They may cause 'cold' burns.

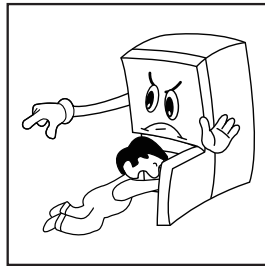

Do not allow children to play or hide in the refrigerator to prevent the risk of trapping and suffocation.

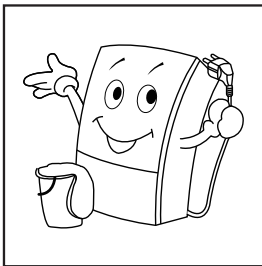

Always unplug before cleaning and servicing.

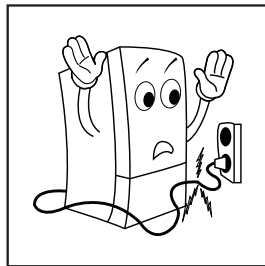

If the power cord is damaged, it must be replaced by the manufacturer or its service agent or a similarly qualified person in order to avoid a hazard.

## HOW TO USE THE REFRIGERATOR COMPARTMENT AND FREEZER COMPARTMENT

Connect the lead to the main (at least wait 2 hours after delivery; refer to section "Before connecting to the mains")  
 Food can be stored after 3 to 4 hours of cooling.  
 - The interior light switches on when the door is opened.  
 - The compressor operates and starts cooling.

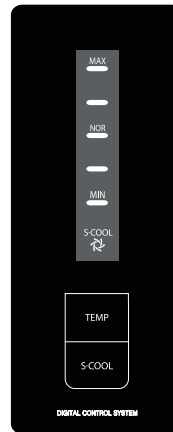

TEMPERATURE CONTROL PANEL)

## OBSERVE AMBIENT TEMPERATURE

This refrigerator is designed to operate in ambient temperature specified by its category, which marked on the rating plate.

Climatic category	Ambient temperature from...to
SN	+10°C to +32°C
N	+16°C to +32°C
ST	+16°C to +38°C
T	+16°C to +43°C

### NOTE

Internal temperature may be affected by such factors as the location of the refrigerator, ambient temperature and frequency of door opening.

"MAX"	Means that both compartment temperatures are colder than position "NOR"
"NOR"	Means normal storage temperatures.
"MIN"	Means that freezer & refrigerator compartment temperatures is warmer than position "NOR"
"S-COOL"	Instant coolig with powerful supply of cold air.
TEMP Button	Button which control the temp
S-COOL Button	Button which control "S-COOL"

- The interior light switches on when the door is opened
- The compressor operates and starts cooling.

1. If you want to change the compartment temperature, push the “TEMP button”. If you press this button, the lamps of position will change and the order is as follows.

**NOR → MAX → MIN → NOR**

2. When you push the “S-COOL button”, The lamp of “S-cool” will flicker with beep. And you push the button again, the lamp of the memorized step will light.
3. When the lamp of temperature that you want lights, you wait about 5 seconds. And you can set the temperature as follow.

(Unit : °C)

STEP	MIN	LOW-NOR	NOR	HIGH NOR	MAX
TEMP	5°C	4°C	3°C	1°C	-1°C

Table.

- The set temperature of each compartment by step.
- Refrigerator is controlled by 5 steps.

4. The suitable storage temperature for fresh food is provided at “NOR” position at an ambient temperature of 16 °C to 32 °C.

**Note :** Initially, both compartments temperatures are set “NOR” position automatically.

#### 5. Defrosting Control

Your appliance is frost free, which means there is no need to manually defrost. It will be carried out automatically.

If you want to prevent an undue rise in the temperature of the frozen food while defrosting the appliance, Please wrap the frozen food in several layers of paper such as newspaper.

## NOTES ON FREEZING AND STORAGE

1. Follow storage times indicated by the frozen food manufacturer.  
Make sure that the packaging is undamaged.
2. Save energy : minimize opening of the door by storing identical food items together.
3. Items suitable for freezing : meat, poultry, fresh, fish, vegetables, fruits, dairy products, bread, baked, goods, pre-cooked meals.
4. Items not suitable for freezing : lettuces, radishes, grapes, whole apples and pears, fatty meats.
5. When you freeze food yourself, pack it in appropriate quantities.  
In order to freeze food right through do not exceed the following quantities to best preserve the quality :  
- fruits and vegetables : up to 1kg,  
- meat : up to 2.5kg.
6. Blanch vegetables after washing and cutting them. (2-3 minutes in boiling water; then quickly cool them down in cold water. When you use a steamer or microwave oven, follow the operating instructions).
7. Keep packs dry in order to avoid them freezing together.
8. Freeze fresh food separately from already frozen foods.
9. Do not salt or season fresh food or blanched vegetables before freezing.  
Other foods may be lightly salted or seasoned.  
The intensity of flavor of some spices can change.
10. Use materials or containers specially suitable for freezing in order to avoid loss of quality.
11. Write contents and date of freezing on the packs.  
Do not exceed the storage time indicated in order to preserve quality.
12. Do not freeze bottles or cans with carbonated drinks, cause they might burst.
13. Take out as much food as is immediately required for thawing. Prepare it as soon as possible after thawing.
14. If you open the door more than one minute, the bell rings every one minute during five minutes
15. Do not block air vents with food. Do not file the inside up. It can interfere with cold air circulation.
16. It could be necessary to reduce the quantity to be frozen if freezing every day is anticipated.
17. Food to be frozen is not to be placed in direct contact with food in storage.
18. Do not place watery food close to the cold air ducts.
19. The freezer basket(Case F “C”) is essential for refrigerating performance.  
Do not move it away from refrigerator.

## WHEN PURCHASING FROZEN FOOD

1. Make sure that the packaging is undamaged (damage may have caused the food to deteriorate). Bulging packs or packs which are marked with liquid stains could have been improperly stored and may have been partially thawed.
2. Leave frozen food purchases until last and transport the items in insulated bags.
3. Place the items in the freezer as soon as possible.
4. Do not refreeze partially thawed food. Consume it within 24 hours.
5. Observe the date of consumption and storage information.

## CLEANING

1. Always disconnect the appliance from the mains supply.
2. Do not use abrasives. Periodically clean with a sponge dampened in lukewarm water. A neutral pH detergent may be used. Rinse and dry with a soft cloth.
3. Wipe the outside with a soft cloth dampened in water.
4. Periodically clean the front grille and the radiator at the back with a vacuum cleaner or a brush.
5. Any increase in temperature of frozen food during cleaning the refrigerator can shorten its storage life.

## PROLONGED DISUSE

1. Empty the refrigerator and freezer compartments.
2. Unplug the appliance from the mains.
3. Clean and dry both compartments.
4. Leave the doors open to prevent the formation of unpleasant odors.

## AFTER SALES SERVICE

Before contacting our After Sales Service Department:

1. Try to remedy the problem (please read section "trouble shooting guide").
2. Restart the appliance to check whether the fault repeats. If the malfunction persists, switch off the appliance and try again after an hour.
3. If the malfunction still persists, then contact our Customer Service, specifying :
  - the nature of the problem,
  - the appliance model number,
  - your full address, telephone number and area code.

**Note** : door opening direction changes carried out by our Customer Service are not covered by the terms of guarantee.

## TROUBLESHOOTING GUIDE

1. The appliance does not work. Check :
  - power failure,
  - properly inserted plug,
  - (if applicable) connection of the two-pole circuit breaker,
  - damage to the mains lead,
  - correct setting of the temperature controls.
2. The temperature inside the compartments is not low enough, Check for :
  - closure of the doors,
  - installation near a heat source,
  - correct setting of the refrigerator / freezer control knob,
  - inhibited air circulation.
3. The refrigerator compartment temperature is too low. Check for :
  - correct setting of the temperature controls.
4. The internal light does not work. Refer to point 1 and then :
  - unplug the appliance from the mains.
  - check the bulb and replace if necessary (max.25W)
  - to change the lamp, first remove the window of the lamp by pulling upper part forward.
  - take out the lamp and replace it for a new one.
  - finally set again window lamp on its place.

## APPLIANCE PACKAGING INFORMATION

All material are environmentally sound! They can be dumped or burned at an incineration plant without danger!

About the materials : The plastics can be recycled and are identified as follows :

- PE : for polyethylene, e.g. the outer covering and the bags in the interior.
- PS : for polystyrene foam, e.g. the pads, which are all free of chlorofluorocarbon.

The carton parts are made from recycled paper and should be disposed of at a waste-paper recycling collection location.

## DISPOSAL OF OLD APPLIANCES

For environmental reasons, refrigeration appliances must be disposed of properly. This applies to your old appliance, and –at the end of its service life–for your new appliance as well.

**Warning!** Before disposing of old appliances make them remove or destroy any snap or latch closures.

This eliminates the danger that playing children lock themselves into the appliance (danger of suffocation!) or place themselves into other life-endangering situations.

### Disposal :

- The appliance may not be disposed of with domestic waste or bulky refuse.
- The refrigerant circuit, especially the heat exchanger at back of the appliance, may not be damaged.
- Information concerning collection schedules or locations can be obtained from the local disposal authorities or town hall.



### NOTICE

(\*Not all Models, Below parts is only for RN-421NP..J422NP..)

**When(you are) installing this product, please follow the picture below.**

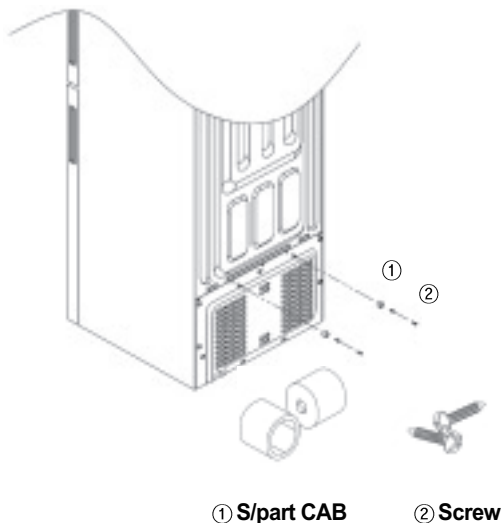

### Disposal of Used Electrical & Electronic Equipment

The meaning of the symbol on the product, its accessory or packaging indicates that this product shall not be treated as household waste.

Please, dispose of this equipment at your applicable collection point for the Contains fluorinated greenhouse gases covered By the Kyoto Protocol and is hermetically sealed.

Recycling of electrical & electronic equipments waste. In the European Union and Other European countries which there are separate collection systems for used electrical and electronic product.

By ensuring the correct disposal of this product, you will help prevent potentially hazardous to the environment and to human health, which could otherwise be caused by unsuitable waste handling of this product.

The recycling of materials will help conserve natural resources.

Please do not therefore dispose of your old electrical and electronic equipment with your household waste.

For more detailed information about recycling of this product, please contact your local city office, your household waste disposal service or the shop where you purchased the product.



## Free Manuals Download Website

<http://myh66.com>

<http://usermanuals.us>

<http://www.somanuals.com>

<http://www.4manuals.cc>

<http://www.manual-lib.com>

<http://www.404manual.com>

<http://www.luxmanual.com>

<http://aubethermostatmanual.com>

Golf course search by state

<http://golfingnear.com>

Email search by domain

<http://emailbydomain.com>

Auto manuals search

<http://auto.somanuals.com>

TV manuals search

<http://tv.somanuals.com>