



Washing Machine Instruction Manual

DWD-F1011/1012/1013'S/F1211/1212/1213'S

INSTRUCTION MANUAL

Economic wash system

Using artificial intelligence, the washer uses minimum energy and water by selecting optimal water level and washing time.

Low noise system

The washer minimizes the washing and spinning noises by sensing the amount of laundry.

Child-Lock

The Child-Lock system has been used to prevent children from pressing any button to change the program during operation.

Nano-silver sterilization washing(Optional)

By applying very fine silver particles on essential parts inside, the washer sterilizes up to 99.9% as is done by boiling wash.

Air bubble washing(Optional)

This is an advanced technology that generates millions of air bubbles inside the drum on washing sequence, and the bubbles dissolve the detergent particles completely and cleanse all the soil in clothes gently and neatly.

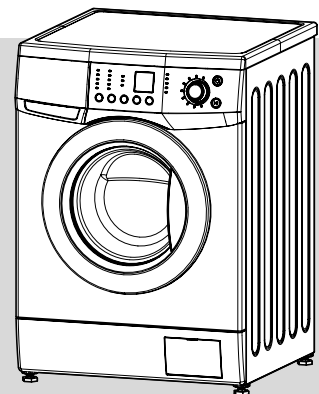

CONTENTS

Page

PARTS AND FEATURES	2
WASHER SAFETY	3
INSTALLATION INSTRUCTIONS	4
INLET HOSE CONNECTION	5
ELECTRICAL REQUIREMENTS	6
OPERATING YOUR WASHER	7
THE FUNCTIONS OF THE CONTROL PANEL	9
WASHING PROCEDURE AND PROGRAM SELECTION	10
MAINTENANCE	19
HOW TO CLEAN THE FILTER	20
REMOVING STAINS	21
TROUBLE SHOOTING	22
SPECIFICATION	23

A NOTE TO YOU

Thank you for buying a DAEWOO appliance.

DAEWOO washers are easy to use, save time, and help you manage your home better.

This manual contains valuable information about how to operate and maintain your washer properly and safely.

Please read it carefully.

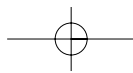

PARTS AND FEATURES

The parts and features of your washer are illustrated on the page. Become familiar with all parts and features before using your washer.

NOTE

The drawings in the book may vary from your washer model. They are designed to show the different features of all models covered by this book, Your model may not include all features.

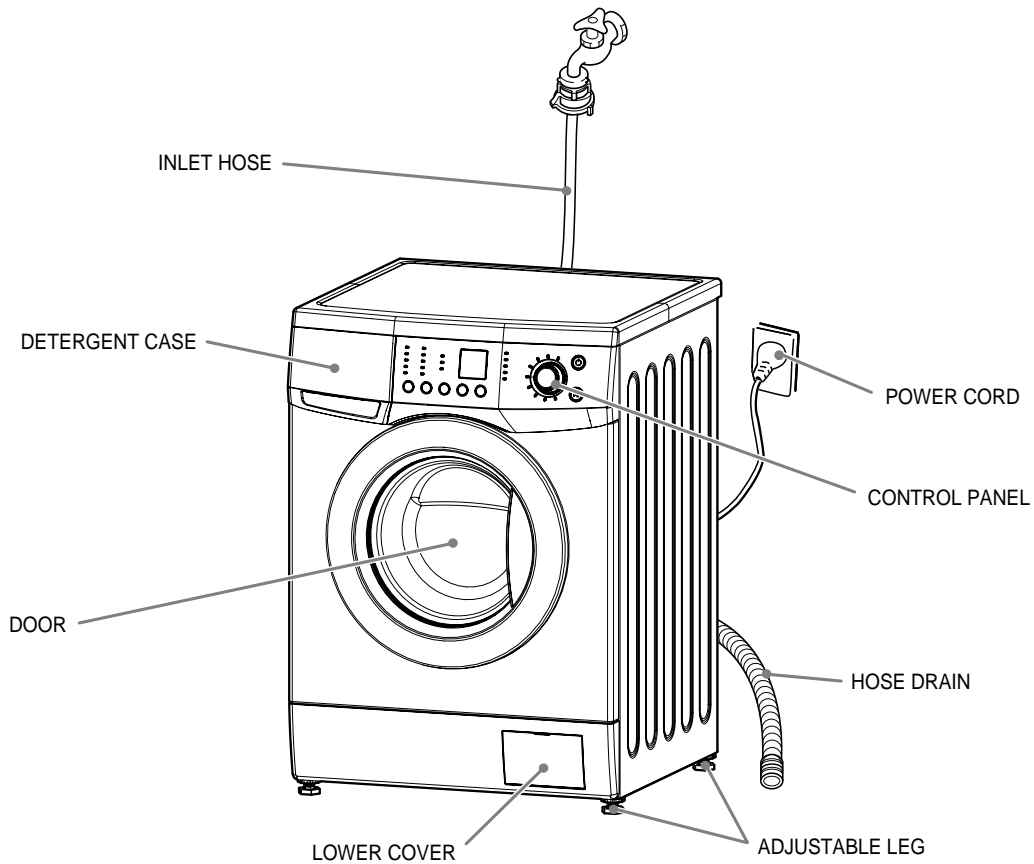

Accessories

Hose drain	Inlet hose	Spanner	Manual	Cap holder(3EA)

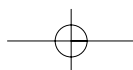

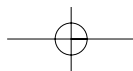

WASHER SAFETY

Save these instructions

Your safety is important to us.

To reduce the risk of fire, electrical shock, or injury when using your washer adhere to the following basic precautions.

Read all instructions before using your washer	
<ul style="list-style-type: none"> • Flammable fluids (dry-cleaning solvents, kerosene, gasoline, etc.) should not be used or stored in or near your washer. Do not add flammable fluids to your wash water. These substances give off vapors that can create a fire hazard or explosion. • After starting a cycle, do not reach into the washer until all motions stop. • Do not tamper with the controls. • The appliance is not intended for use by young children or infirm persons without supervision. • If the supply cord is damaged, it must be replaced by the manufacturer, or its service agent or a similarly qualified person in order to avoid a hazard. • If the appliance is supplied from a cord extension set or electrical portable outlet device it should be positioned so that it is not subjected to splashing or ingress of moisture. 	<p>Please ...</p> <ul style="list-style-type: none"> • Have only a qualified person install, repair, or replace parts on washer. • Maintain washer properly. • Protect washer from the weather and keep it where the temperature will not fall below freezing. • Do not install the washer at a place of extremely high humidity. It could cause an electric shock or a short circuit. • Connect washer to the correct outlet, electrical supply, water supply, and drain supply.

Understanding your responsibilities

- Do not use chlorine bleach and ammonia or acid (such as vinegar or rust remover) in the same wash. Hazardous fumes can form.
- Unplug power supply cord before attempting to service your washer.
- Do not wash fiberglass material.
Small particles can stick to fabrics washed in following loads and cause skin irritation.
- Do not spray water on the control panel of the washer.
It could cause fire or an electric shock.
- In case of the dual valve model, if you connect only cold water inlet valve, while water temperature is selected as hot or warm, there can be water leakage from unconnected water inlet valve.
- This appliance must be grounded.
To avoid electrical shock, use a metal pipe for the ground connection.

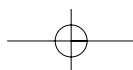

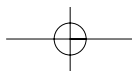

INSTALLATION INSTRUCTIONS

Removing transit bolts

1. Before operating the washer, remove the transit bolts(3ea) along with the rubber.
 - If the bolts are not removed, it may cause heavy vibration, noise and malfunction.

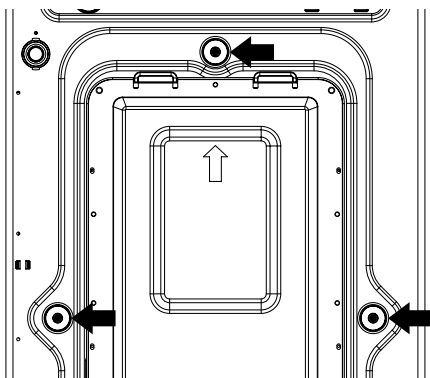

2. Unscrew the 3 bolts with the spanner supplied. Keep the 3 bolts and spanner for future use.
 - Whenever the appliance is transported, the transit bolts must be refitted.

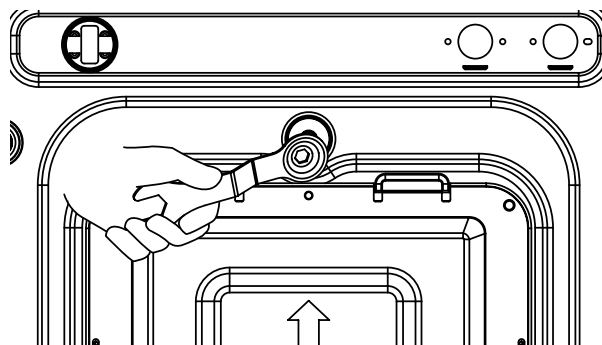

3. Close the holes with the cap holders supplied.

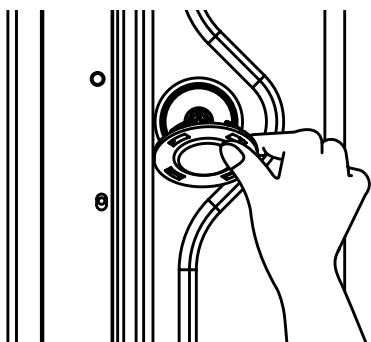

Location of washer

- Check location where the washer will be installed. Make sure you have everything necessary for correct installation.
- Do not place or store your washer below 0°C (32°F) to avoid any damage from freezing.
- Do not place or store laundry products on top of washer at any times.
- Install the washer on the horizontal solid floor.

If the washer is installed on an unsuitable floor, it could make considerable noise, vibrate severely and cause a malfunction. If the washer is not level, adjust leg up or down for horizontal installation.
- Ventilation openings must not be obstructed by carpeting when the washer is installed on a carpeted floor.
- Leave some space (right & left : 2cm, rear : 10cm).
- In case of built-in installation, the distance between top of the washer and bottom of upper plate should be at least 3mm.

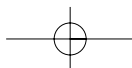
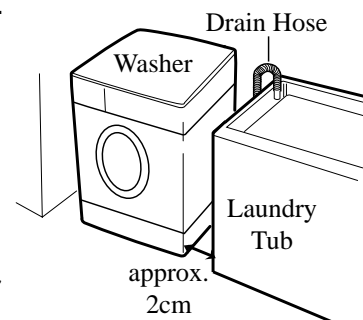

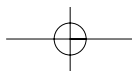

INLET HOSE CONNECTION

The washer should be connected to the water mains using new hose sets and old hose sets should not be reused.



In using only one water tap or in case of only one water inlet valve, connect the inlet hose to the cold water inlet valve.

Option : Be careful not to confuse hot water inlet and cold water inlet.

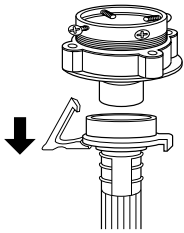
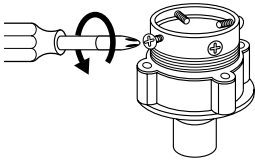
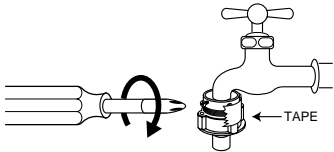
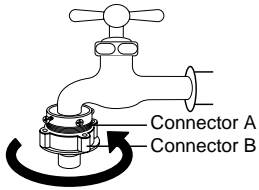
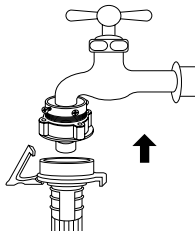
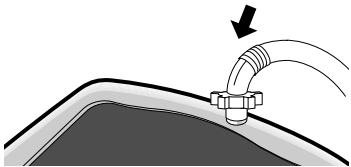
For Ordinary Tap

<p>① Pull down the collar of the inlet hose to separate it from the water tap adapter.</p> 	<p>② Loosen the four screws properly in order to fit into water tap.</p> 	<p>③ Fit the water tap adapter into the water tap and tighten the four screws evenly while pushing up the adapter so that the rubber packing can stick to the water tap tightly.</p> 
<p>④ Remove the tape, and screw connector B into connector A tightly.</p> 	<p>⑤ Connect the inlet hose to the water tap adapter by pulling down the collar of the hose end.</p> 	<p>⑥ Connect the inlet hose adapter of the hose to the water inlet of the washer by turning it clockwise to be fixed tightly.</p>  <p>• Please check the rubber packing present inside the inlet hose adapter of the hose.</p>

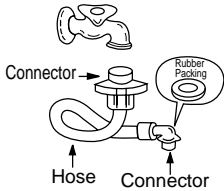
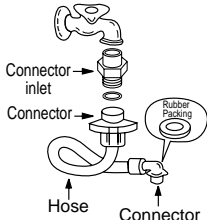
For Screw-Shaped Tap

<p>① Connect the inlet hose to the water tap by screwing the connector tightly.</p> 	<p>② Connect the connector-inlet supplied if necessary.</p> 	<p>③ Connect the inlet hose adapter to the water inlet of a washer and turn it to be fixed.</p>  <p>*Check the packing in the inlet</p>
---	---	--

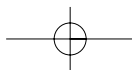

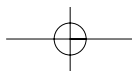

ELECTRICAL REQUIREMENTS

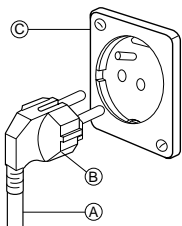
WARNING	Electrical shock hazard : Failure to follow these instructions could result in death or serious injury.	
<ul style="list-style-type: none"> • Electrical earth is required on this washer • If it does not fit the outlet, have a proper outlet installed by a qualified electrician. 	<ul style="list-style-type: none"> • Don't earth to a gas pipe. • Don't change the power supply cord plug. • Check with a qualified electrician if you are not sure the washer is properly earthed. 	
Recommended earthing method		
	<p>For your personal safety, this washer must be earthed.</p> <p>This washer is equipped with a power supply cord 'A' having an earthing plug 'B'. To minimize possible shock hazard, the cord must be plugged into a mating earthing-type wall receptacle 'C'. If a mating wall receptacle is not available, it is the personal responsibility and obligation of the customer to have the proper earthed wall receptacle installed by a qualified electrician.</p>	

Drain system

- Never forget to install drain hose before operating your washer.
- Open the packing box, and there is a drain hose inside the drum.
- Connect the drain hose to the drain outlet at the back side of the washer.
- Top of laundry tub must be at least 60cm high and no higher than 100cm from bottom of washer.

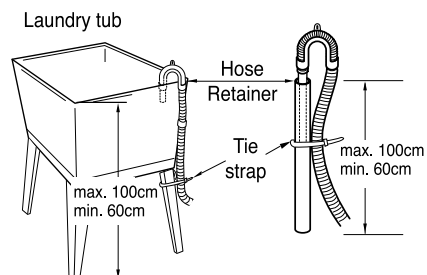
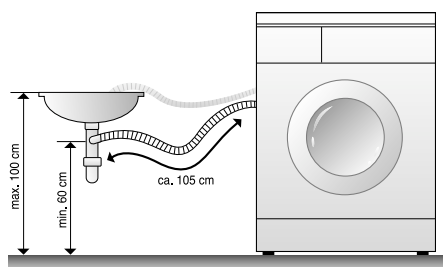

- When installing the drain hose to tub(sink), secure it tightly with a string.
- Proper securing of the drain hose will protect the floor from damage due to water leakage.
- When the drain hose is too long, do not force it back into the washer. This will cause abnormal noise.

Level adjustment

- ① If the washer is installed on an unsuitable floor, it could make considerable noise, vibrate and cause a malfunction.

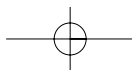

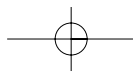

② Adjust the level of washer using adjustable legs.

- Please check if there is any gap between the four adjustable legs and the floor.
- Turning adjustable legs by the enclosed spanner, adjust the level of washer and make it sure that there is no swaying of washer.
- After the adjustment is finished, turn the fixing nuts up tightly so that the washer maintains the adjustment.

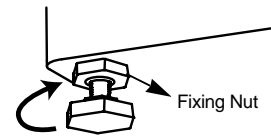
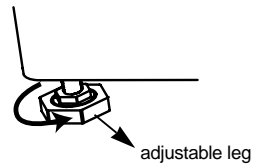

③ Make it sure that the washer does not sway when you press down the four corners of the washer's top plate.

NOTE

There should be no swaying of washer and all the adjustable legs should stick to the floor closely.

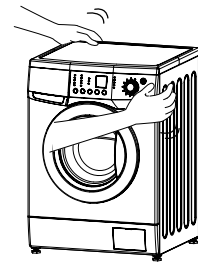

OPERATING YOUR WASHER

To obtain the best washing results, you must operate your washer properly. This section gives you this important information.

Preparing clothes for washing	
<ul style="list-style-type: none"> • Close zippers, snaps, and hooks to avoid snagging other items. Remove pin, buckles, and other hard objects to avoid scratching the washer interior. • Empty pockets and pull them inside out. 	<ul style="list-style-type: none"> • Turn down cuffs and turn synthetic knits inside out to avoid pilling. • Tie strings and sashes to avoid tangling. • Treat spots and stains. (See "Removing stains" on page 21)

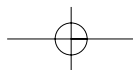
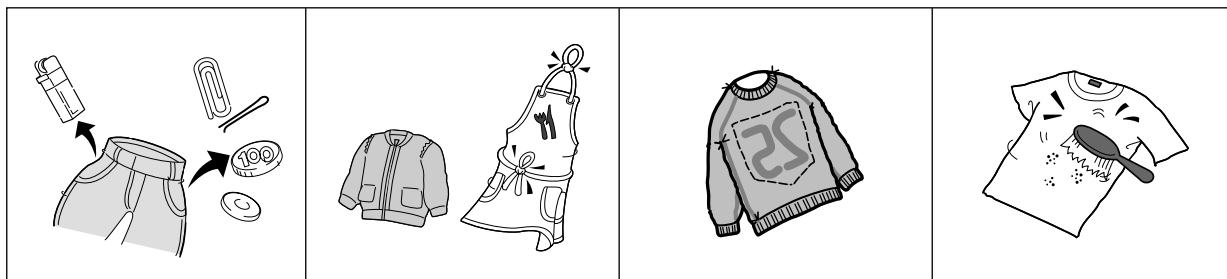

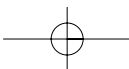

Sorting

- Separate heavily soiled items from lightly soiled ones, even if they would normally be washed together.
- Separate dark colors from light colors, colorfast items from non-colorfast item.

Soil (Heavy, Normal, Light)	Separate clothes according to amount of soil.
Color (White, Lights, Dark)	Separate white clothes from colored clothes.
Lint (Lint producers, Collectors)	Wash lint producers and lint collectors separately.

Loading

- | | |
|---|---|
| <ul style="list-style-type: none"> • Drop items into washer loosely. Items should move easily through wash water for best cleaning and wrinkle-free results. • Load washer properly and select correct load size setting.
Overloading and selecting a setting too small for the wash load can : <ul style="list-style-type: none"> - Cause poor cleaning - Increase wrinkling - Create excessive lint - Wear out items faster (because of pilling) | <ul style="list-style-type: none"> • Mix large and small items in each load. Load evenly to maintain washer balance. An unbalanced load can make the washer vibrate during spin. • Reduce wash time when using a small load size setting. Load with only a few small items needs less wash time. • Use a large load size setting to reduce wrinkling with permanent press clothes and some synthetic knits. These items should have more room to move in the water than heavy items. (towels, jeans) |
|---|---|

Adding detergent

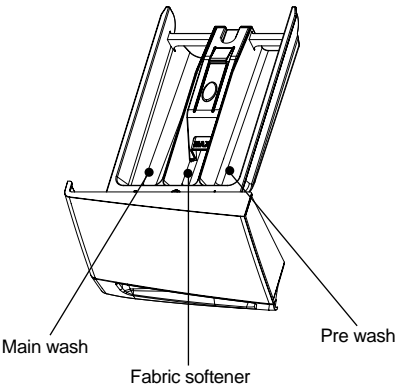

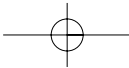

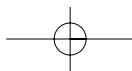

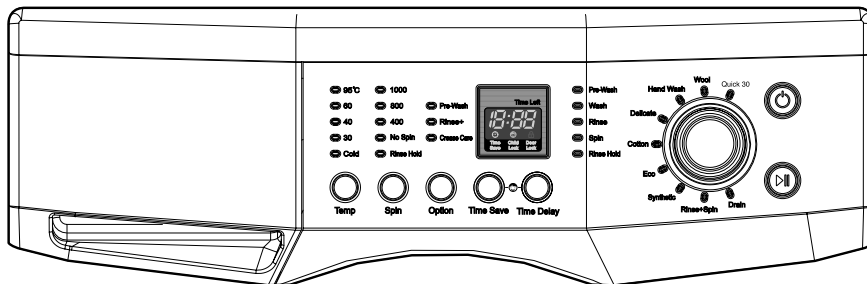

<p>① Detergent case</p> 	<p>② Adding fabric softener</p> <ul style="list-style-type: none"> • If desired, add measured liquid fabric softener to the softener inlet. • Pour liquid fabric softener into the dispenser using the amount recommended on the package. • Do not exceed the maximum fill line. Overfilling can cause early dispensing of the fabric softener which could stain clothes. • Do not open the detergent case when water is supplied. • Avoid pouring fabric softener directly on the clothes.
---	--





THE FUNCTIONS OF THE CONTROL PANEL

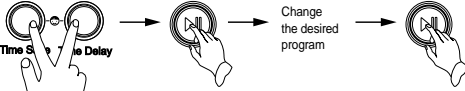

 Power	Press this switch to turn the power on or off.
 Start/Hold	Operation and temporary stop is repeated as it is pressed. When you want to change program in operating; press the "Start/Hold" button Select the program that you want to change press the "Start/Hold" button again.
	You can select the course you want, and each lamp is turned on when that course is selected. For the more detailed information, please refer to the page 11~18.
 Temp	It can be used to adjust temperature of water according to types of the load to be washed. As the button is pressed, temperature of water is selected by Cold 30°C 40°C 60°C 95°C
 Spin	By pressing the spin button, the spin speed can be chosen. Rinse Hold <ul style="list-style-type: none"> • Is selected by pressing the spin button repeatedly. This function leaves clothes in the machine; suspended in the water after a rinse without entering into spin. • To proceed through to a drain or spin, after the Rinse Hold function is completed, use spin button. No spin <ul style="list-style-type: none"> • If no spin is selected, the washer stops after draining water.
 Option	Crease Care <ul style="list-style-type: none"> • If you want to prevent crease, select this button with spin speed. Rinse+ <ul style="list-style-type: none"> • Is used to add a rinse, which may assist in removing traces of detergent residue. • By selecting Rinse+ function, the rinse time and the rinse water are increased. Pre-Wash <ul style="list-style-type: none"> • The washer operates one additional wash and spin before the main wash. • If the laundry is heavily soiled, Pre-Wash course is effective. • Pre-Wash is available in Cotton and Synthetic programs.
 Time Save	All courses have pre-set washing times, but Time Save decreases it to 10 minutes. Each time this button is pressed the watch icon is repeated on and off. When it is on, the Time Save function is set. Time Save is available in Cotton, Eco and Synthetic programs.
 Time Delay	It can be used to pre-engage time for wash.
 Time Save Time Delay	Use this function when you want to protect any accident occurring from handling of washer by a child. During an operation of washer, press 'Time Save' and 'Time Delay' buttons simultaneously. In Child Lock mode, no button functions except Power button. In Child Lock mode, press 'Time Save' and 'Time Delay' buttons simultaneously like setting Child Lock and Child Lock is cancelled. To change to the desired program, while in Child Lock mode; 1. Press both the Time save and Time delay buttons together once again. 2. Press the Start/Hold button. 3. Select the desired program and press the Start/Pause button again.  * The child lock can be set at any time and it is automatically cancelled when operational errors occur. Also Child Lock works also when power is off.

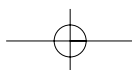

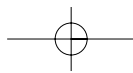

WASHING PROCEDURE AND PROGRAM SELECTION

1. COTTON IS AUTOMATICALLY SELECTED UPON POWER ON

- Press the Power button to start.
- Press the Start/Hold button
- Initial condition
 - Program : Cotton
 - Wash : main wash
 - Rinse : 3 times
 - Spin : 800 rpm
 - Water temperature : 40°C

2. MANUAL SELECTING

- Press the Power button to start
- Select the conditions which you want to use by turning the program dial and pressing each button.
- Press the Start/Hold button.

3. RESERVED WASHING

- Reservation can be made from 2 hours to 12 hours.
example) To make reservation to complete washing in 8 hours.
- Procedure to press the button.

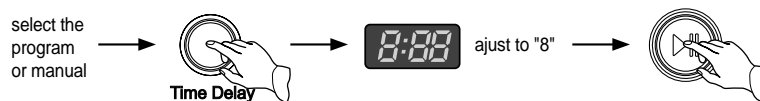

- * Each pressing of the button advances time delay by one hour.
- Now the reservation is made.
- If you want to check the selected program, press the "Start/Hold" button again.
- Preparing washing before starting "Time Delay";
 - Turn on the water tap
 - Load laundry and close the door
 - Place the detergent and fabric softener in the detergent case.
- To cancel the time delay, press the Power button.

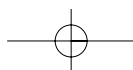

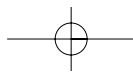

4. FUNCTION

- Recommended programs according to the laundry type

Program	Fabirc Type	Proper Temp.	Option	Maximum Load
Cotton	First check if laundry is machine washable.(white cotton, linen towel and sheets..)	60°C (95°C)	Pre Wash Rinse+ Crease Care	Rating
	Colorfast garments (shirts, night dresses, pajamas..) and lightly soiled white cottons (underwear..)	40°C (60°C, 30°C)	Pre Wash Rinse+ Crease Care	Rating
Eco	Laundry type is the same as Cotton.	60°C	Pre Wash Rinse+ Crease Care	Rating
Synthetic	Polyamide, Acrylic, Polyester	40°C (60°C, 30°C)	Pre Wash Rinse+ Crease Care	Less than 1.5kg
Delicate	Delicate laundry easily damaged (silk, curtains..)	Cold	Rinse+ Crease Care	Less than 1.0kg
Wool	Machine washable woolens with pure new wool only.	Cold	Rinse+ Crease Care	Less than 1.0kg
Hand Wash	"Hand wash" marked delicate and wool laundry	Cold (30°C)	Rinse+ Crease Care	Less than 1.0kg
Quick	Colored laundry which is lightly soiled fast.	30°C (Cold, 40°C)	Rinse+ Crease Care	Less than 1.0kg

- Pre Wash : If the laundry is heavily soiled, "Pre Wash" program is recommended.
Pre Wash is available in Cotton and Synthetic programs.
- Rinse+ : Used to introduce an additional rinse, which may assist in removing traces of detergent residue.
- Eco : By selecting Eco function, the water temperature is lowered and washing time is increased.
So you can economize your consumption of heating energy.

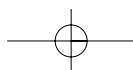

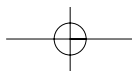

* COTTON PROGRAM

1	<p>Put the laundry in to the drum. Put detergent and softener into the detergent case. Then close the door.</p> <ul style="list-style-type: none"> • Put detergent into the main wash and prewash compartments in the detergent case. Softener should be below the 'MAX' level. • Put detergent into the pre wash compartment only if you want to add prewash. • When you want to use bleach, put it into the main wash compartment with detergent.
2	<p>Press the Power button.</p> <ul style="list-style-type: none"> • The LED shows only '---' and all Program Lights turn on.
3	<p>Select the 'Cotton' program using program selection dial.</p> <ul style="list-style-type: none"> • If you press Start/Hold button after power button without selecting program, the 'Cotton' program is selected as default program. • Washing temperature '40' °C, spin '800' rpm and rinse '3' times are selected automatically. • If you want to change washing temperature, the spin velocity or add wash options (Rinse+, Crease Care), press each button.
4	<p>Press Start/Hold button.</p> <ul style="list-style-type: none"> • The Door is locked. By sensing the weight of laundry and supplying wash water, The appliance starts washing.

Note

- If you want to change the setting during operation, press the Start/Hold button to hold the operation and press the button you want.
- '30', '40', '60' and '95' °C washing temperatures are selectable with Cotton program.
- 'Prewash', 'Rinse+', and 'Crease Care' wash options are selectable with Cotton program.

Caution!

- If you select washing temperature '95' °C, some cold water is supplied before the drain of main wash. This is to protect the user from the hazard of burn injury by lowering the temperature of hot wash water instead of directly draining it. Therefore this is not a malfunction.
(Be careful with the draining water, since it can be still hot although the temperature is lowered.)

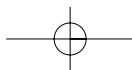

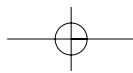

* ECO PROGRAM

1	<p>Put the laundry in the drum. Put detergent and softener into the detergent case. Then close the door.</p> <ul style="list-style-type: none"> • Put detergent into the main wash and prewash compartments in the detergent case. Softener should be below the 'MAX' level. • Put detergent into the pre wash compartment only if you want to add prewash. • When you want to use bleach, put it into the main wash compartment with detergent.
2	<p>Press the Power button.</p> <ul style="list-style-type: none"> • The LED shows only '---' and all Program Lights turn on.
3	<p>Select the 'Eco' program using program selection dial.</p> <ul style="list-style-type: none"> • Washing temperature '60' °C, spin '800' rpm and rinse '3' times are selected automatically. • If you want to change the spin velocity or add wash options (Rinse+, Crease Care), press each button.
4	<p>Press Start/Hold button.</p> <ul style="list-style-type: none"> • The Door is locked. By sensing the weight of laundry and supplying wash water, The appliance starts washing.

Note

- If you want to change the setting during operation, press the Start/Hold button to hold the operation and press the button you want.
- Only '60' °C washing temperature is selectable with Eco program.
- Only 'Rinse+' and 'Crease Care' of all wash options are selectable with Eco program.

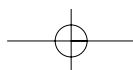

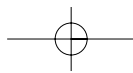

* SYNTHETIC PROGRAM

1	<p>Put the laundry in the drum. Put detergent and softener into the detergent case. Then close the door.</p> <ul style="list-style-type: none"> • Put detergent into the main wash and prewash compartments in the detergent case. Softener should be below the 'MAX' level. • Put detergent into the pre wash compartment only if you want to add prewash. • When you want to use bleach, put it into the main wash compartment with detergent.
2	<p>Press the Power button.</p> <ul style="list-style-type: none"> • The LED shows only '---' and all Program Lights turn on.
3	<p>Select the 'Synthetic' program using program selection dial.</p> <ul style="list-style-type: none"> • Washing temperature '40' °C, spin '800' rpm and rinse '3' times are selected automatically. • If you want to change washing temperature, the spin velocity or add wash options (Prewash, Rinse+, Crease Care), press each button.
4	<p>Press Start/Hold button.</p> <ul style="list-style-type: none"> • The Door is locked. By sensing the weight of laundry and supplying wash water, The appliance starts washing.

Note

- If you want to change the setting during operation, press the Start/Hold button to hold the operation and press the button you want.
- Only '30', '40' and '60' °C washing temperatures are selectable with Synthetic program.
- 'Prewash', 'Rinse+', and 'Crease Care' wash options are selectable with Synthetic program.
- The appropriate amount of laundry for Synthetic program is below 1.5kg.

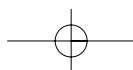

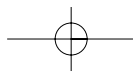

* DELICATE PROGRAM

1	<p>Put the laundry in the drum. Put detergent and softener into the detergent case. Then close the door.</p> <ul style="list-style-type: none"> • Put detergent into the main wash and prewash compartments in the detergent case. Softener should be below the 'MAX' level. • Put detergent into the pre wash compartment only if you want to add prewash. • When you want to use bleach, put it into the main wash compartment with detergent.
2	<p>Press the Power button.</p> <ul style="list-style-type: none"> • The LED shows only '---' and all Program Lights turn on.
3	<p>Select the 'Delicate' program using program selection dial.</p> <ul style="list-style-type: none"> • Washing temperature 'Cold', spin '400' rpm and rinse '2' times are selected automatically. • If you want to change the spin velocity or add wash options (Rinse+, Crease Care), press each button.
4	<p>Press Start/Hold button.</p> <ul style="list-style-type: none"> • The Door is locked. By sensing the weight of laundry and supplying wash water, The appliance starts washing.

Note

- If you want to change the setting during operation, press the Start/Hold button to hold the operation and press the button you want.
- Only 'cold' of washing temperature is selectable with Delicate program.
- '1000' rpm of spin velocity is NOT selectable with Delicate program.
- Only 'Rinse+' and 'Crease Care' wash options are selectable with Delicate program.
- The appropriate amount of laundry for Delicate program is below 1.0kg.

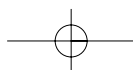

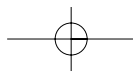

* WOOL PROGRAM

1	<p>Put the laundry in the drum. Put detergent and softener into the detergent case. Then close the door.</p> <ul style="list-style-type: none"> • Put detergent into the main wash and prewash compartments in the detergent case. Softener should be below the 'MAX' level. • Put detergent into the pre wash compartment only if you want to add prewash. • When you want to use bleach, put it into the main wash compartment with detergent.
2	<p>Press the Power button.</p> <ul style="list-style-type: none"> • The LED shows only '---' and all Program Lights turn on.
3	<p>Select the 'Wool' program using program selection dial.</p> <ul style="list-style-type: none"> • Washing temperature 'Cold', spin '400' rpm and rinse '2' times are selected automatically. • If you want to change the spin velocity or add wash options (Rinse+, Crease Care), press each button.
4	<p>Press Start/Hold button.</p> <ul style="list-style-type: none"> • The Door is locked. By sensing the weight of laundry and supplying wash water, The appliance starts washing.

Note

- If you want to change the setting during operation, press the Start/Hold button to hold the operation and press the button you want.
- Only 'Cold' washing temperature is selectable with Wool program.
- '1000' rpm of spin velocity is NOT selectable with Hand program in order to protect damage on laundry.
- Only 'Rinse+' and 'Crease Care' wash options are selectable with Wool program.
- The appropriate amount of laundry for Wool program is below 1.0kg.
- Use only special detergent for wool.
(Since special neutral detergent for wool creates a lot of bubbles, use appropriate amount).

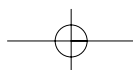

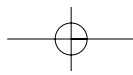

* HAND WASH

1	<p>Put the laundry in the drum. Put detergent and softener into the detergent case. Then close the door.</p> <ul style="list-style-type: none"> • Put detergent into the main wash and prewash compartments in the detergent case. Softener should be below the 'MAX' level. • Put detergent into the pre wash compartment only if you want to add prewash. • When you want to use bleach, put it into the main wash compartment with detergent.
2	<p>Press the Power button.</p> <ul style="list-style-type: none"> • The LED shows only '---' and all Program Lights turn on.
3	<p>Select the 'Hand Wash' program using program selection dial.</p> <ul style="list-style-type: none"> • Washing temperature 'Cold', spin '400' rpm and rinse '3' times are selected automatically. • If you want to change the washing temperature, spin velocity or add wash options (Rinse+, Crease Care), press each button.
4	<p>Press Start/Hold button.</p> <ul style="list-style-type: none"> • The Door is locked. By sensing the weight of laundry and supplying wash water, The appliance starts washing.

Note

- If you want to change the setting during operation, press the Start/Hold button to hold the operation and press the button you want.
- Only 'Cold' and '30' °C washing temperatures are selectable with Hand Wash program.
- '1000' rpm of spin velocity is NOT selectable with Hand program.
- Only 'Rinse+' and 'Crease Care' wash options are selectable with Hand Wash program.
- Use Hand Wash program for the laundry that is marked 'Hand wash' in the care label.

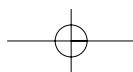

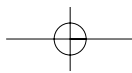

* QUICK 30

1	<p>Put the laundry in the drum. Put detergent and softener into the detergent case. Then close the door.</p> <ul style="list-style-type: none"> • Put detergent into the main wash and prewash compartments in the detergent case. Softener should be below the 'MAX' level. • Put detergent into the pre wash compartment only if you want to add prewash. • When you want to use bleach, put it into the main wash compartment with detergent.
2	<p>Press the Power button.</p> <ul style="list-style-type: none"> • The LED shows only '---' and all Program Lights turn on.
3	<p>Select the 'Quick' program using program selection dial.</p> <ul style="list-style-type: none"> • Washing temperature '30' °C, spin '800' rpm and rinse '2' times are selected automatically. • If you want to change the washing temperature, spin velocity or add wash options (Rinse+, Crease Care), press each button.
4	<p>Press Start/Hold button.</p> <ul style="list-style-type: none"> • The Door is locked. By sensing the weight of laundry and supplying wash water, The appliance starts washing.

Note

- If you want to change the setting during operation, press the Start/Hold button to hold the operation and press the button you want.
- Only 'Cold', '30' °C and '40' °C washing temperatures are selectable with Quick 30 program.
- Only 'Rinse+' and 'Crease Care' wash options are selectable with Quick 30 program.

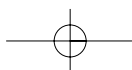

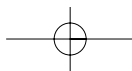

MAINTENANCE

Proper care of your washer can extend its life. This section explains how to care for your washer properly and safely.

Cleaning your washer

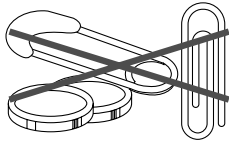
Exterior	Interior
<p>Wipe up detergent, bleach, and other spills with a soft, damp cloth or sponge as they occur. Occasionally wipe the outside of the washer to keep its looking like new one.</p> 	<p>Clean interior with 250ml of chlorine bleach mixed with 500ml of detergent. Run washer through a complete cycle. Repeat this process if necessary.</p>
<p>Do not put sharp or metal object in your washer, or they can damage the finish. Check all pockets for pins, clips, money, bolts, nuts, etc. Do not lay these objects in your washer after emptying pockets.</p> 	

Winter storage or moving care

Install and store your washer where it will not freeze. Because some water may stay in the hoses, freezing can damage your washer.

If you store or move your washer during freezing weather, winterize it.

To winterize washer	To use washer again
<ul style="list-style-type: none"> • Turn off water faucet. • Disconnect and drain water inlet hoses. • Run washer on a drain and spin setting (see page 10) for 1 minute. • Unplug the power supply cord. 	<ul style="list-style-type: none"> • Flush water pipes and hoses. • Reconnect water inlet hoses. • Turn on water faucet. • Reconnect power supply cord.

Non-use or vacation care

Operate your washer only when you are at home.

If you are on vacation or don't use your washer for an extended period of time, you should:

- Unplug the power supply cord or turn off electrical power to the washer.
- Turn off the water supplier to the washer.

This helps avoid accidental flooding (due to a water pressure surge) while you are away.

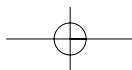

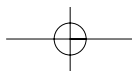

HOW TO CLEAN THE FILTER

Cleaning the water inlet filter

- Clean the filter when water leaks from the water inlet.

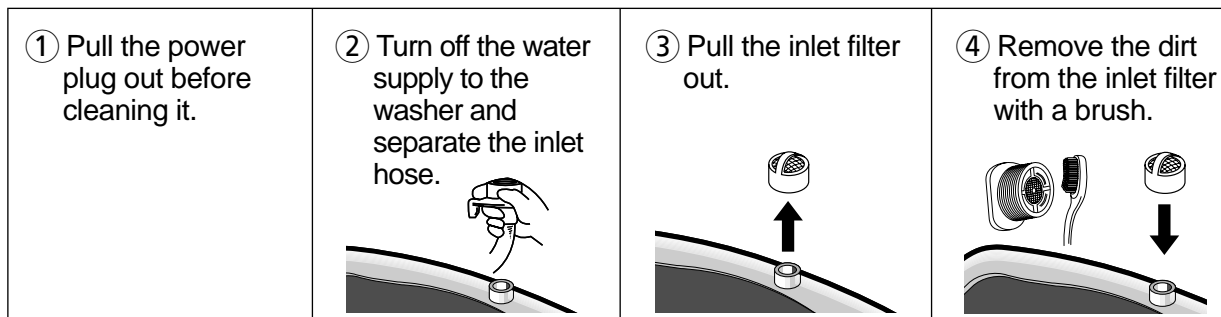

Cleaning the drain filter

- This drain filter is used to screen the foreign stuffs such as threads, coins, pins, buttons etc..
- If the drain filter is not cleaned at proper time (every 10 times of use), drain problem could be caused.

CAUTION : Be careful when draining if the water is hot.

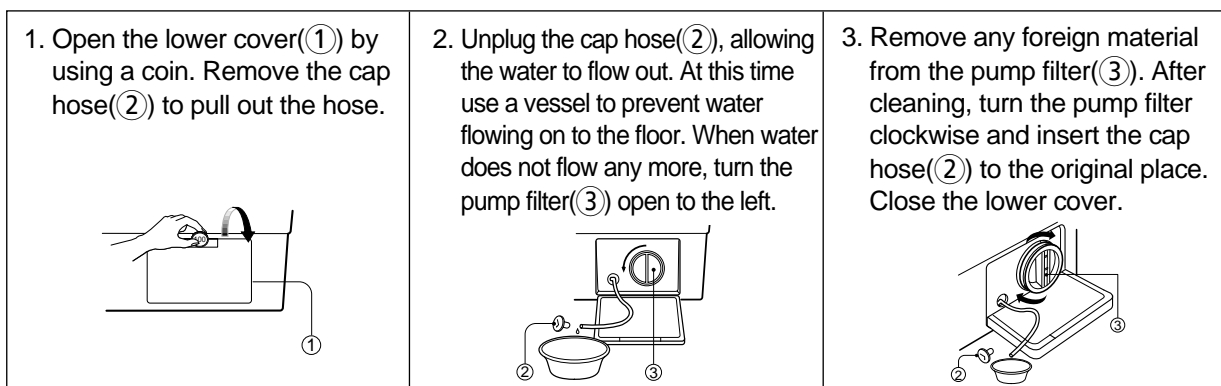

Cleaning the detergent case

*After a while detergent and fabric softeners leave a deposit in the case;

- It should be cleaned from time to time with a jet of running water.
- If necessary it can be removed completely from the machine by pressing the catch downwards and by pulling it out.
- To facilitate cleaning, the upper part of the fabric softener compartment can be removed.

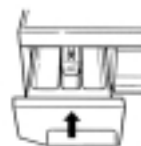
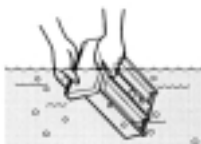
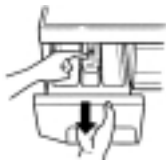

*Detergent can also accumulate inside the recess which should be cleaned occasionally with a brush.

*Once you have finished cleaning, replace the case and run a rinse cycle without laundry.

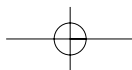

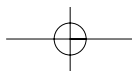

REMOVING STAINS

Stained, heavily-soiled, or greasy items may need to be prewashed or soaked for best results. Soaking helps remove protein-type stains like blood, milk or grass. Prewashing helps loosen soil before washing.

Stain removal rules

- Use warm water for soaking or prewashing stained laundry. Hot water can set stains.
- Most stains are easier to remove when they are fresh.
- Before treating any stain, find out what kind of stain it is, how old the stain is, what kind of fabric it is, and whether the fabric is colorfast. (Check the care label)
- Washing and drying can set some stains.
- Start with cold or warm water. Hot water can set some stains.
- When bleach is recommended, use a bleach that is safe for the fabric.
- Put the stained area face down on a paper towel or white cloth. Apply the stain remover to the back of the stain. This forces the stain off fabric instead of through it.

Stain removal guide

STAIN	TO REMOVE
Blood	Rinse immediately in COLD water. If stain remains, soak in cold water with an enzyme prewash.
Chewing gum	Use ice in plastic bag to harden the gum. Scrape off what you can and the sponge with white spirits.
Cocoa, Chocolate	Sponge with COLD water and soak in an enzyme prewash. If stains persist, rub in a little detergent and rinse in cold water.
Coffee	Blot up quickly and rinse out in COLD water. Rub in a little detergent and wash in the maximum temperature allowed for the fabric type.
Cream/Milk Ice cream	Rinse in COLD water and wash normally. If stain is still apparent, sponge with white spirits.
Deodorant	Rub affected area with white vinegar and then rinse out in COLD water. Sponge with white spirits. Treat stiffened areas with enzyme prewash.
Egg	Soak in a COLD enzyme prewash, rinse and wash normally.
Fabric/Softener	Rub affected area with bar soap and wash normally.
Fruit stains	Treat as soon as possible by sponging with COLD water. Rub a little detergent on the stain and wash normally.
Grass	Sponge with white spirits. Rub in an enzyme prewash and wash as normally.
Grease and oil	Lay the affected area face down on an absorbent cloth and work from the back. Sponge with white spirits or dry cleaning fluid. Wash normally.
Iron or rust	Apply lemon juice and salt and place in the sun. Wash normally.
Lipstick	Sponge with white methylated spirits and wash normally.
Mildew	Wash in WARM water and detergent. Moisten area with lemon juice, dry in the sun and wash normally. If stain persists and the fabric allows, use a bleach.
Mud	Brush off any dry mud. Rinse in cold water. If stain persists rub in a little detergent and wash normally.
Paint-oil based	Scrape off any fresh paint and sponge with a non flammable dry cleaning fluid and wash normally.
Paint-water based	Treat while still wet, rinse in WARM water and wash normally.
Scorch marks	Dampen a cloth with hydrogen peroxide, lay it over the affected area and press with a fairly hot iron.

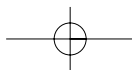

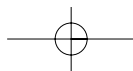

TROUBLE SHOOTING

Most problems are easily solved if you understand the cause.

Check the following list for problem before calling for service.

If error mode such as IE, OE, UE were displayed on the control part, in this case, how to solve these problem is first open and close the door, and then press START/HOLD button.

PROBLEM	CHECK POINT
<ul style="list-style-type: none"> The washer will not operate at all. 	<ul style="list-style-type: none"> Is there a power failure? Is the power cord correctly connected to an electric outlet? Did you turn on the power? Did you press Start/Hold button? Is there correct amount of laundry in the washer.
<ul style="list-style-type: none"> Water is not supplied <p>Error display IE</p>	<ul style="list-style-type: none"> Did you connect the inlet hose and open the water tap? Is the inlet hose or the water tap frozen? Is the water supply shot off? Is there any foreign matter blocking up the inlet hose filter?
<ul style="list-style-type: none"> The washer will not drain <p>Error display OE</p>	<ul style="list-style-type: none"> Is the drain hose frozen or blocked up by dirt? Is the drain hose kinked or deformed? Is the end of the drain hose immersed in water? Is there excessive dirt inside the drain filter?
<ul style="list-style-type: none"> The washer will not spin <p>Error display UE</p>	<ul style="list-style-type: none"> Is the clothes in the drum collected on one side? Is the washer installed on an uneven floor or is the vibration serious? Is the door open? (The lamp "UE" will light up in this case.)
<ul style="list-style-type: none"> Vibrating and too noisy 	<ul style="list-style-type: none"> Is the washer installed on an uneven floor? Have all the transit bolts removed?

These cases are not malfunctions;

- The sound "wing" heard during water supply is the operating sound made by the water inlet valve.
- The sound "sha" heard in stopping the tub is the sound that comes from the autobalancer of the tub.

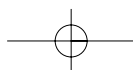

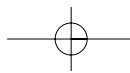

SPECIFICATION

MODEL	DWD-F1011/F1012/F1013	DWD-F1211/F1212/F1213
Dimension (mm)	595 x 540 x 850 (WxHxD)	
Maximum mass of textile (kg)	6.0	
Unit Weight (kg)	64(Net) / 68(Gross)	
Standard Water Consumption	50 l	
Spin Speed (RPM)	No Spin/400/800/1000	No Spin/400/800/1200
Operating Water Pressure	0.03MPa ~ 0.8MPa (0.3kgf/cm ² ~ 8kgf/cm ²)	

WIRING DIAGRAM

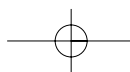
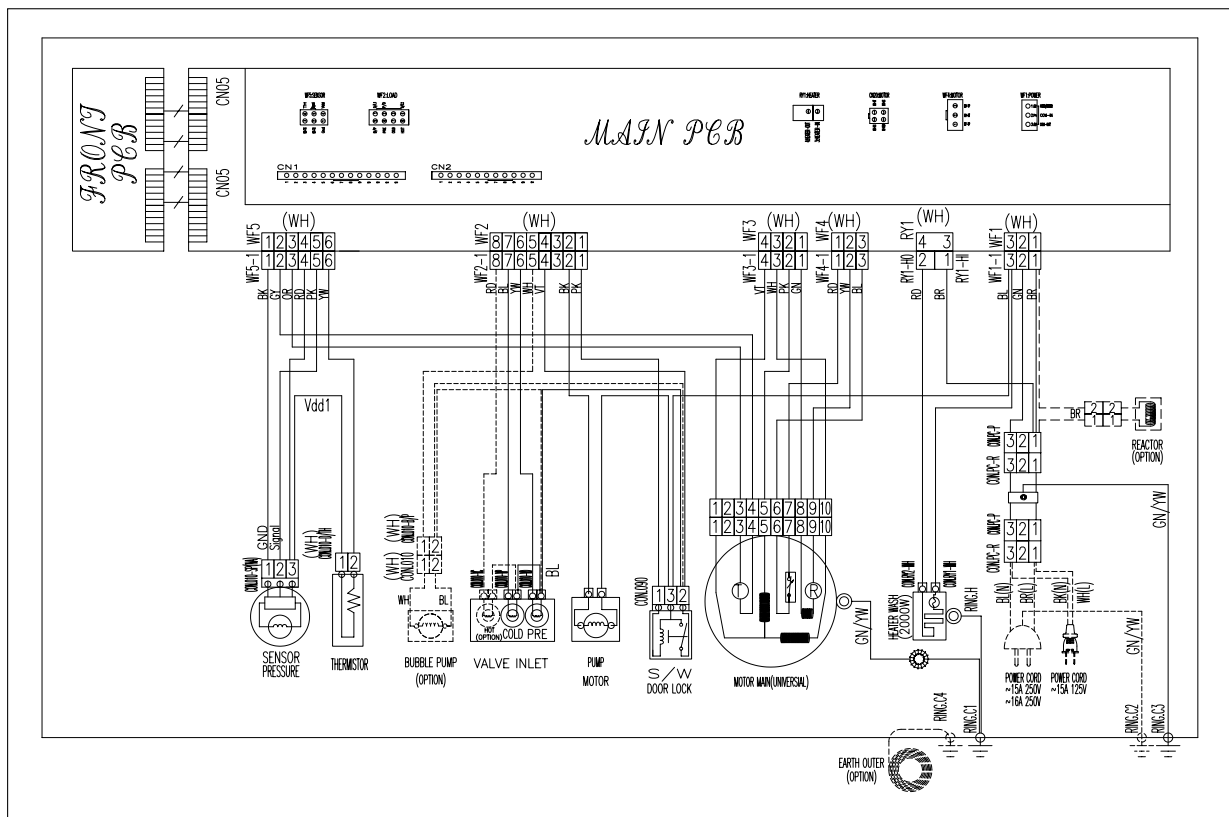

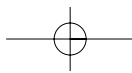

English

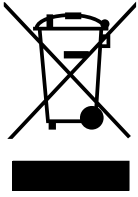
Disposal of Used Electrical & Electronic Equipment

The meaning of the symbol on the product, its accessory or packaging indicates that this product shall not be treated as household waste. Please, dispose of this equipment at your applicable collection point for the recycling of electrical & electronic equipments waste. In the European Union and Other European countries which there are separate collection systems for used electrical and electronic product. By ensuring the correct disposal of this product, you will help prevent potentially hazardous to the environment and to human health, which could otherwise be caused by unsuitable waste handling of this product. The recycling of materials will help conserve natural resources. Please do not therefore dispose of your old electrical and electronic equipment with your household waste. For more detailed information about recycling of this product, please contact your local city office, your household waste disposal service or the shop where you purchased the product.

Português

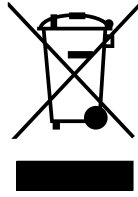
Eliminação de Equipamento Eléctrico e Electrónico Usado

O símbolo no aparelho, nos seus acessórios ou na embalagem indica que este aparelho não deve ser tratado como resíduos domésticos. Deixe deste aparelho no ponto de recolha de material eléctrico e electrónico para reciclagem mais perto de si. Na União Europeia e noutros países europeus existem sistemas de recolha separada para produtos eléctricos e electrónicos usados. Garantindo uma eliminação correcta deste aparelho, ajudará a evitar possíveis danos ambientais e/ou pessoais, que um incorrecto tratamento do aparelho usado poderia provocar. A reciclagem de materiais ajuda a conservar os recursos naturais. Por isso, não deite fora os aparelhos eléctricos e electrónicos junto com os seus resíduos domésticos. Para informação detalhada sobre a reciclagem deste aparelho, contacte a sua Câmara Municipal, o seu serviço de recolha de lixo ou a loja onde comprou o aparelho.

Deutsch

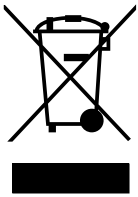
Entsorgung von gebrauchten elektrischen und elektronischen Geräten (Anzuwenden in den Ländern der Europäischen Union und anderen europäischen Ländern mit einem separaten Sammelsystem für diese Geräte)

Das Symbol auf dem Produkt oder seiner Verpackung weist darauf hin, dass dieses Produkt nicht als normaler Haushaltsabfall zu behandeln ist, sondern an einer Annahmestelle für das Recycling von elektrischen und elektronischen Geräten abgegeben werden muss. Durch Ihren Beitrag zum korrekten Entsorgen dieses Produkts schützen Sie die Umwelt und die Gesundheit Ihrer Mitmenschen. Umwelt und Gesundheit werden durch falsches Entsorgen gefährdet. Materialrecycling hilft den Verbrauch von Rohstoffen zu verringern. Weitere Informationen über das Recycling dieses Produkts erhalten Sie von Ihrer Gemeinde, den kommunalen Entsorgungsbetrieben oder dem Geschäft, in dem Sie das Produkt gekauft haben.

Nederlands

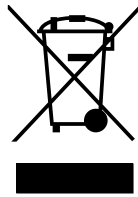
Verwijdering van Oude Elektrische en Elektronische Apparaten (Toepasbaar in de Europese Unie en andere Europese landen met gescheiden ophaalsystemen)

Het symbool op het product of op de verpakking wijst erop dat dit product niet als huishoudafval mag worden behandeld. Het moet echter naar een plaats worden gebracht waar elektrische en elektronische apparatuur wordt gerecycled. Als u ervoor zorgt dat dit product op de correcte manier wordt verwijderd, voorkomt u mogelijk voor mens en milieu negatieve gevolgen die zich zouden kunnen voordoen in geval van verkeerde afvalbehandeling. De recyclage van materialen draagt bij tot het vrijwaren van natuurlijke bronnen. Voor meer details in verband met het recyclen van dit product, neemt u het best contact op met de gemeentelijke instanties, het bedrijf of de dienst belast met de verwijdering van huishoudafval of de winkel waar u het product hebt gekocht.

Español

Eliminación de equipamiento eléctrico y electrónico usado

Este símbolo en el producto, sus accesorios o embalaje indica que el producto no debe tratarse como un residuo doméstico. Deshágase de este equipamiento en su punto de recogida más cercano para el reciclaje de residuos eléctricos y electrónicos. En la Unión Europea y otros países europeos existen diferentes sistemas de recogida de productos eléctricos y electrónicos usados. Al asegurar la correcta eliminación de este producto ayudará a evitar riesgos potenciales para el medio ambiente y la salud de las personas que podrían tener lugar si el producto no se eliminara de forma adecuada. El reciclaje de materiales ayudará a conservar los recursos naturales. Por consiguiente, no elimine equipamiento eléctrico y electrónico usado junto con residuos domésticos. Para información más detallada acerca del reciclaje de este producto, póngase en contacto con su oficina municipal, el servicio de eliminación de residuos domésticos o el establecimiento donde adquirió el producto.

French

Traitement des appareils électriques et électroniques en fin de vie (applicable dans les pays de l'union européenne et aux autres pays européens disposant de systèmes de collecte sélective).

Ce symbole, apposé sur le produit ou sur son emballage, indique que ce produit ne doit pas être traité avec les déchets ménagers. Il doit être remis à un point de collecte approprié pour le recyclage des équipements électriques et électroniques. En s'assurant que ce produit est bien mis au rebut de manière appropriée, vous aiderez à prévenir les conséquences négatives potentielles pour l'environnement et la santé humaine. Le recyclage des matériaux aidera à conserver les ressources naturelles. Pour toute information supplémentaire au sujet du recyclage de ce produit, vous pouvez consulter votre municipalité, votre déchetterie ou le magasin où vous avez acheté le produit.

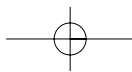

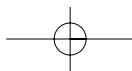

Italiano

Trattamento del dispositivo elettrico od elettronico a fine vita (Applicabile in tutti i paesi dell'Unione Europea e in quelli con sistema di raccolta differenziata)

Questo simbolo sul prodotto o sulla confezione indica che il prodotto non deve essere considerato come un normale rifiuto domestico, ma deve invece essere consegnato ad un punto di raccolta appropriato per il riciclo di apparecchi elettrici ed elettronici. Assicurandovi che questo prodotto sia smaltito correttamente, voi contribuirete a prevenire potenziali conseguenze negative per l'ambiente e per la salute che potrebbero altrimenti essere causate dal suo smaltimento inadeguato. Il riciclaggio dei materiali aiuta a conservare le risorse naturali. Per informazioni più dettagliate circa il riciclaggio di questo prodotto, potete contattare l'ufficio comunale, il servizio locale di smaltimento rifiuti oppure il negozio dove l'avete acquistato.

Česky

Likvidace použitých elektrických a elektronických zařízení

Tento symbol na výrobku, jeho příslušenství nebo obalu označuje, že s tímto výrobkem nesmí být zacházeno jako s domovním odpadem. Výrobek zlikvidujte jeho předáním na sběrné místo pro recyklaci elektrických a elektronických zařízení. V zemích evropské unie a jiných evropských zemích existují samostatné sběrné systémy pro shromažďování použitých elektrických a elektronických výrobků. Zajištěním jejich správné likvidace pomůžete prevenci vzniku potenciálních rizik pro životní prostředí a lidské zdraví, která by mohla vzniknout nesprávným zacházením s odpady. Recyklace odpadových materiálů napomáhá udržení přírodních zdrojů surovin - z uvedeného důvodu nelikvidujte prosím vaše stará elektrická a elektronická zařízení s domovním odpadem. Pro získání podrobných informací k recyklaci tohoto výrobku kontaktujte prosím pracovníka ochrany životního prostředí místního (městského nebo obvodního) úřadu, pracovníky sběrného dvora nebo zaměstnance prodejny, ve které jste výrobek zakoupili.

Poland

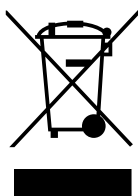
Utylizacja niepotrzebnego sprzętu elektrycznego i elektronicznego

Taki symbol na produkcie lub na jego opakowaniu oznacza, że produkt nie może być traktowany jako odpad komunalny, lecz powinien być dostarczony do odpowiedniego punktu zbiórki sprzętu elektrycznego i elektronicznego, w celu przerobu i odzysku odpadów. W krajach Unii Europejskiej i w pozostałych krajach europejskich są odrębne systemy segregacji odpadów przeznaczone do utylizacji sprzętu elektrycznego i elektronicznego.

Przez takie pro ekologiczne zachowanie zapobiegają Państwo potencjalnym negatywnym wpływom na środowisko naturalne oraz na zdrowie ludzi, jakie mogłyby wystąpić w przypadku niewłaściwego procesu składowania tego produktu. Przez zagospodarowanie materiałów oszczędzamy również surowce naturalne. Aby uzyskać bardziej szczegółowe informacje na temat przerobu i odzysku materiałów elektronicznych z tego produktu, proszę skontaktować się z urzędem miasta lub gminy, lokalnym zakładem utylizacji sprzętu elektrycznego i elektronicznego lub ze sklepem, w którym produkt został zakupiony.

Slovensky

Likvidácia použitých elektrických a elektronických zariadení

Tento symbol na výrobku, jeho príslušenstve alebo obale označuje, že sa s týmto výrobkom nesmie zaobchádzať ako s domovým odpadom. Výrobok zlikvidujte jeho odovzdaním na zbernom mieste pre recykláciu elektrických a elektronických zariadení. V krajinách európskej únie a v iných európskych krajinách existujú samostatné zberné systémy pre zhromažďovanie použitých elektrických a elektronických výrobkov. Zaistením ich správnej likvidácie pomôžete prevencii vzniku potenciálnych rizík pre životné prostredie a ľudské zdravie, ktoré by mohli vzniknúť nesprávnym zaobchádzaním s odpadmi. Recyklácia odpadových materiálov napomáha udržaniu prírodných zdrojov surovín - z uvedeného dôvodu nelikvidujte prosím vaše staré elektrické a elektronické zariadenia s domovým odpadom.

Pre získanie potrebných informácií k recyklácii tohto výrobku kontaktujte prosím pracovníka ochrany životného prostredia miestneho (mestského či obvodného) úradu, pracovníkov zberného dvora alebo zamestnancov predajne, v ktorej ste výrobok zakúpili.

Magyar



Feleslegessé vált elektromos és elektronikus készülékek hulladékként való eltávolítása (Használható az Európai Unió és egyéb európai országok szelektív hulladékgyűjtési rendszereiben)

Ez a szimbólum a készüléken vagy a csomagolásán azt jelzi, hogy a terméket ne kezelje háztartási hulladékként. Kérjük, hogy az elektromos és elektronikai hulladék gyűjtésére kijelölt gyűjtőhelyen adja le. A feleslegessé vált termékének helyes kezelésével segít megelőzni a környezet és az emberi egészség károsodását, mely bekövetkezhetne, ha nem követi a hulladék kezelés helyes módját. Az anyagok újrahasznosítása segít a természeti erőforrások megőrzésében. A termék újrahasznosítása érdekében további információért forduljon a lakóhelyén az illetékesekhez, a helyi hulladékgyűjtő szolgáltatóhoz vagy ahhoz az üzlethez, ahol a terméket megvásárolta.

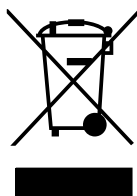
Slovensko

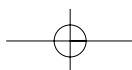

Oddaja stare električne in elektronske opreme (veljavno v evropski uniji in ostalih evropskih državah s sistemom zbiranja ločenih odpadkov)

Če se na izdelku ali na njegovi embalaži nahaja ta simbol, pomeni, da z izdelkom ne smete ravnati enako kot z drugimi gospodinjstskimi odpadki. Morate ga oddati na ustrezno zbirno mesto za recikliranje električne in elektronske opreme. S pravilno oddajo tega izdelka boste pomagali preprečiti negativne posledice na okolje in zdravje ljudi, do katerih bi prišlo v primeru neustreznega ravnanja ob odstranitvi tega izdelka. Recikliranje materiala bo pripomoglo k ohranjanju naravnih virov. Podrobnejše informacije o recikliranju tega izdelka lahko dobite pri lokalni mestni upravi, službi oddajanja gospodinjstskih odpadkov ali v trgovini, kjer ste izdelek kupili. Odpadno električno in elektronsko opremo lahko oddate brezplačno tudi distributerju neposredno ob dobavi električne oz. elektronske opreme.

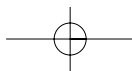

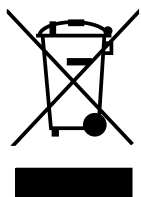

Svenska

Omhändertagande av gamla elektriska och elektroniska produkter (Användbar i den Europeiska Unionen och andra Europeiska länder med separata insamlingsystem)

Symbolen på produkten eller emballaget anger att produkten inte får hanteras som hushållsavfall. Den skall i stället lämnas in på uppsamlingsplats för återvinning av el- och elektronikkomponenter. Genom att säkerställa att produkten hanteras på rätt sätt bidrar du till att förebygga eventuellt negativa miljöoch hälsoeffekter som kan uppstå om produkten kasseras som vanligt avfall. Återvinning av material hjälper till att bibehålla naturens resurser. För ytterligare om återvinning bör du kontakta lokala myndigheter eller sophämtningstjänst eller affären där du köpte varan.

Dansk

Håndtering af udtjente elektriske og elektroniske produkter (Gælder for den Europæiske Union og andre europæiske lande med separate indsamlingssystemer)

Dette symbol på produktet eller emballagen angiver, at produktet ikke må behandles som husholdningsaffald. Det skal i stedet indleveres på en deponeringsplads specielt indrettet til modtagelse og oparbejdning af elektriske og elektroniske produkter. Ved at sikre at produktet bortskaffes korrekt, forebygges de eventuelle negative miljø- og sundhedsskadelige påvirkninger, som en ukorrekt affaldshåndtering af produktet kan forårsage. Genindvinding af materialer vil medvirke til at bevare naturens ressourcer. Yderligere information om genindvindingen af dette produkt kan fås hos myndighederne, det lokale renovationsselskab eller butikken, hvor produktet blev købt.

Norsk

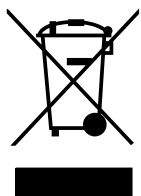

Avhending av gamle elektriske og elektroniske apparater (gjelder i den Europeiske Unionen og andre europeiske land med separat innsamlingsystem)

Dette symbolet på produktet eller innpakningen indikerer at dette produktet ikke må håndteres som husholdningsavfall. I stedet skal det leveres inn til spesielt innsamlingspunkt for gjenvinning av det elektriske og elektroniske utstyret. Ved å sørge for at dette produktet avhendes på korrekt måte, vil du hjelpe til med å forhindre potensielle negative påvirkninger på miljøet og helse, som ellers kan være resultatet av feilaktig avfallshåndtering av dette produktet. Gjenvinning av disse materialene vil hjelpe til med å ta vare på våre naturressurser. For mer informasjon om gjenvinning av dette produktet, kan du kontakte lokale myndigheter.

Suomi

Käytöstä poistetun sähkö-ja elektroniikkalaitteen hävitys (Euroopan Unioni ja muiden Euroopan maiden keräysjärjestelmät)

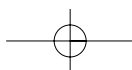
Symboli, joka on merkitty Tuotteeseen tai sen pakkaukseen, osoittaa, että tätä tuotetta ei saa käsitellä talousjätteenä. Tuote on sen sijaan luovutettava sopivaan sähkö-ja elektroniikkalaitteiden kierrätyksestä huolehtivaan keräyspisteeseen. Tämän tuotteen asianmukaisen hävittämisen varmistamisella autetaan estämään sen mahdolliset ympäristöön ja terveyteen kohdistuvat haittavaikutukset, joita voi aiheutua muussa tapauksessa tämän tuotteen epäasianmukaisesta jätekäsittelystä. Materiaalien kierrätys säästää luonnonvaroja. Tarkempia tietoja tämän tuotteen kierrättämisestä saa paikallisesta kunnantoinmistosta.



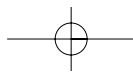

ABOUT THIS MANUAL

VISION CREATIVE, INC.

6

4

		TEL
MODEL	DWD - F1011N/1012N/1013N/1211N/1212N/1213N 'S	
BUYER	(DEER) - 가 _DWD - F1011/1012/1013/1211/1212/1213 'S	
	1	6
	2	7
	3	8
	4	9
	5	10
MEMO 05.5.19 - (Basic)		

VISION

TEL: 730 - 0660 FAX: 730 - 3788

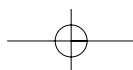

Free Manuals Download Website

<http://myh66.com>

<http://usermanuals.us>

<http://www.somanuals.com>

<http://www.4manuals.cc>

<http://www.manual-lib.com>

<http://www.404manual.com>

<http://www.luxmanual.com>

<http://aubethermostatmanual.com>

Golf course search by state

<http://golfingnear.com>

Email search by domain

<http://emailbydomain.com>

Auto manuals search

<http://auto.somanuals.com>

TV manuals search

<http://tv.somanuals.com>