

LCD Display & TV

Operating Instructions

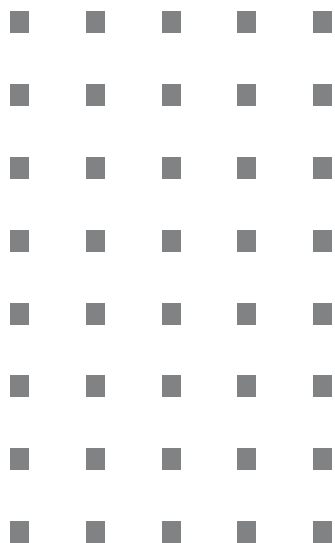

LCD TV

A Wide Array of Screen Settings

You can choose different screen settings depending on the type of program you are watching or the surrounding conditions (the lighting or the outside weather conditions). You can switch among the Sport, Movie, Music and Normal options , or you can configure the screen settings yourself.

A Wide Array of Sound Settings

You can choose an optimal sound setting for the type of program you are watching. You can switch among the Music, Movie, News and Normal options , or you can configure the settings yourself.

Favorite Channel Memory

You can store your favorite channels in the order of preference for easy channel selection.

Captions

When you watch a captioned program, you can turn the caption option on to see English text on the screen. This feature also works with video CDs or videotapes with captions.



**WARNING
AVERTISSEMENT**



RISQUE DE CHOC ÉLECTRIQUE-NE PAS OUVRIR.

WARNING HIGH-VOLTAGE

TO PREVENT FIRE OR SHOCK HAZARD DO NOT REMOVE COVER.
NO USER SERVICEABLE PARTS INSIDE.

REFER ALL SERVICE QUERIES TO QUALIFIED PERSONNEL.

DO NOT EXPOSE THIS RECEIVER TO RAIN OR MOISTURE.

REMOVE MAINS PLUG FROM WALL SOCKET WHEN NOT IN USE.

CARE SHOULD BE TAKEN WHEN REMOVING BACK CABINET FOR SERVICING,
SUB CHASSIS MAY BE DAMAGED IF ALLOWED TO BECOME UNSUPPORTED.



This symbol is intended to alert the user to the presence of uninsulated "dangerous voltage" within the product's enclosure that may be of sufficient magnitude to constitute a risk of electric shock to persons.



This symbol is intended to alert the user to the presence of important operating and maintenance (servicing) instructions in the literature accompanying the appliance.

WARNING - To reduce the risk of fire or shock hazard, do not expose the TV to rain or moisture.

NOTICE

- If the same pattern is continuously displayed on the Monitor / TV for a long period of time, it can be the situation when the image "Sticks" to screen.
- This apparatus shall not be exposed to dripping or splashing and no object filled with liquids, such as vases, shall be placed on the apparatus.

Important Safety Instructions

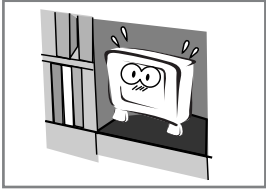

The unit should not be placed in a built-in installation such as a book-case, limited space rack unless proper ventilation is provided.

- This may cause fire by overheating or damage the unit by falling.

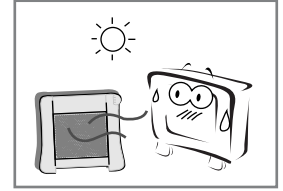

Do not use the unit in direct sunlight and keep it away from heaters, stoves, and other sources of heat.

- This may cause a fire.

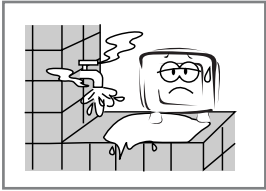

Do not use the unit near water, oil or inflammables.

- This may cause a fire.

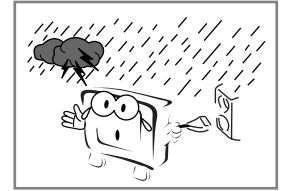

During storm conditions (especially when there is lightning) unplug your TV set from the main electrical outlet and antenna.

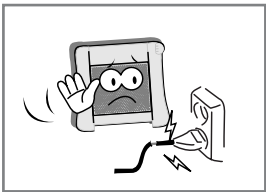

Do not use a damaged plug and do not let the power cord touch a heat source.

- This may cause an electric shock or fire.

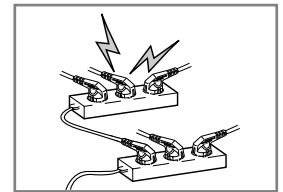

Do not connect too many extension cords or plugs to an outlet.

- This may cause a fire.

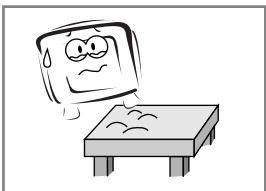

Place the unit on a flat and stable surface.

- The unit can cause injury or damage the unit by falling.

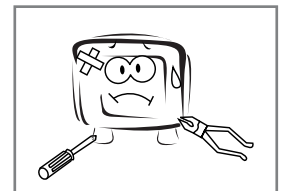

Do not attempt to service the unit.

Contact an authorized dealer or repair service.

- Servicing the unit yourself may cause an electric shock or fire.

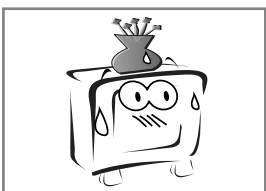

Do not place any things(vase, stc) on the top of the unit.

- This may cause the damage of the unit by falling.

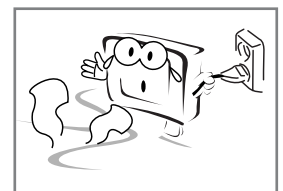

If there are any unusual sounds or smells coming from the unit, unplug it immediately and contact an authorized dealer or repair service.

- This may be caused by an electric shock or fire.

Important Safety Instructions

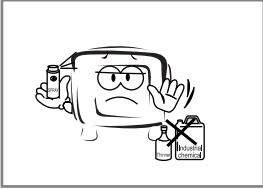

Do not use or store inflammable substances near the unit
- This may cause an explosion or fire.

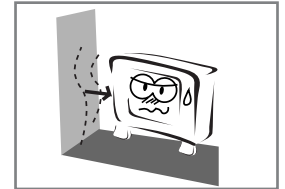

Place the unit away from the wall for well ventilation.
- This may cause a fire.

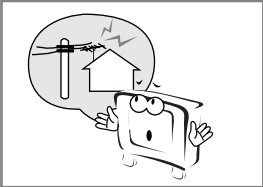

Place the antenna away from the electric wire, not to touch even though it falls down by wind.
- This may cause an electric shock.

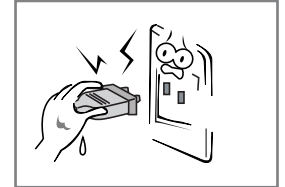

Do not touch the plug with wet hands.
- This may cause an electric shock.

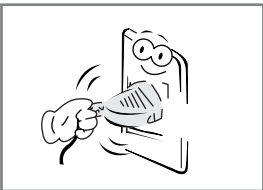

Be sure to plug in tightly and hold the plug, not the cord when disconnecting the plug from the wall outlet.
- This may cause a fire.



If an outside antenna is connected to the unit, do not let the rain water get into the unit by bending or antenna wire sealing
- This may cause an electric shock or fire.

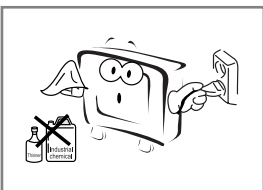

Unplug the unit from the wall outlet before cleaning. Use a smooth cloth. Do not use industrial chemicals.
- This may cause an electric shock or fire.

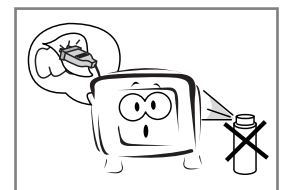

If the connector between the plug and the pin is dusty or dirty, clean it. Do not spray detergent directly on the unit.
- This may cause an electric shock or fire.

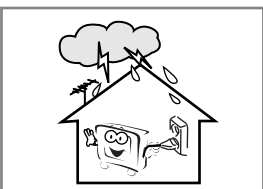

Do not touch the antenna wire and disconnect the plug from the electrical outlet during storms or lightening.
- This may cause an electric shock or fire.

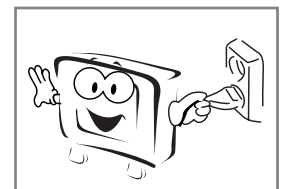

Disconnect the plug from the outlet if it is not used for a long period of time.
- This may cause an electric shock or fire.

Table of Contents

Important Safety Instructions	3
Unpacking your TV	6
Viewing the Control Panels (Front View)	7
Viewing the Control Panels (Rear View)	9
Remote Control	10
Inserting Batteries in the Remote Control	11
Connecting an Antenna or Cable	11
Connecting to the RCA or S-Video Input (Side AV2)	12
Connecting to the SCART Input	12
Connecting to a DVD or DTV Set-Top Box INPUT (RCA or DVI)	13
Connecting the Headphones	14
Connecting the Power Cord and Switching the TV On / Off	15
Selecting a Picture from External Sources	15
Selecting your Language	15
Storing Channels in Memory	16
Customizing the Picture	19
Customizing the Sound	20
Setting the Date & Time	21
3D SOUND function	22
Listening to Stereo Sound / Dual Sound	22
Displaying the TV Information	22
PC SET UP	23
Favourite channel function	24
Display the Picture in Picture (PIP)	25
Display a Still Image	26
Changing the Picture Size	27
Noise & OSD Setting	28
Teletext Functions	28
Displaying the Teletext Information	29
Selecting a Special Teletext Functions	29
Connecting to the PC (DVI)	30
Setting the PC Software	31
Standard Display Mode	32
Pin Configuration	33
Troubleshooting	34
Specifications	36

Unpacking your TV

Please make sure the following items are included with your TV set.
If any items are missing, contact your dealer.

Accessories

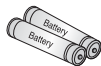

Remote Control & Batteries (AAA x 2)

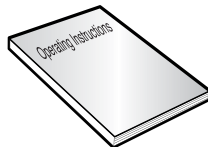

Operating Instructions

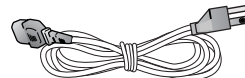

Power Cord

Viewing the Control Panels

Front View



Right Side

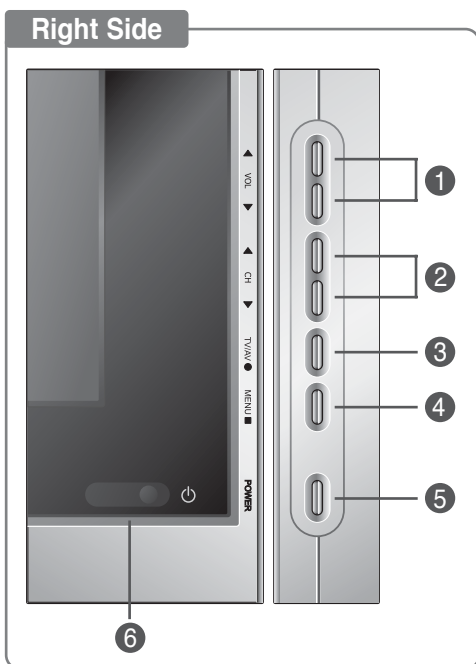

- ① Volume adjustment
- ② Channel selection
- ③ Input TV/AV selection
- ④ MENU selection
- ⑤ Power
- ⑥ Remote control sensor

Power Indicator Status

Indicator	Status
Red	Stand-by
Green	Power on

Viewing the Control Panels

Front View



Bottom Side

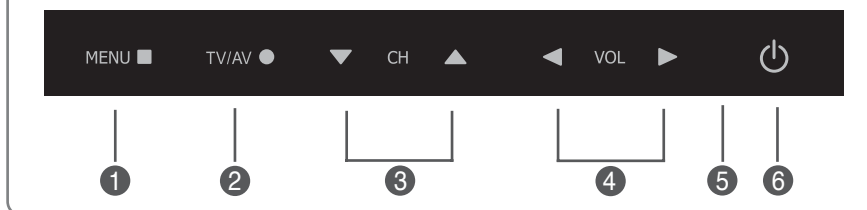

- ① MENU selection
- ② Input TV/AV selection
- ③ Channel selection
- ④ Volume adjustment
- ⑤ Remote control sensor
- ⑥ Power

Power Indicator Status

Indicator	Status
Red	Stand-by
Green	Power on

Viewing the Control Panels

Rear View

Right Side

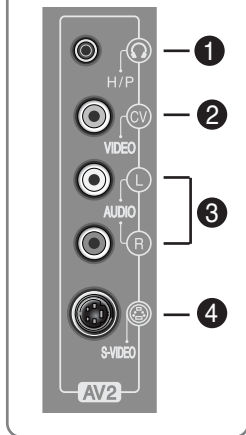

- 1 Headphone Jack
- 2 AV2 VIDEO Input
- 3 AV2 AUDIO Input
- 4 AV2 S-VIDEO Input



LCD - 26" / 32"

Bottom Side

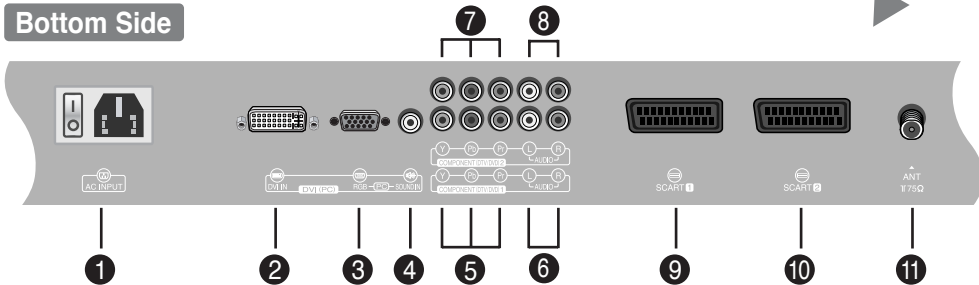

- 1 Power Inlet with Switch
- 2 DVI Input (PC)
- 3 RGB Video Input (PC)
- 4 PC Audio Input
- 5 COMPONENT1 Video Input (DTV/DVD)
- 6 COMPONENT1 Audio Input (DTV/DVD)
- 7 COMPONENT2 Video Input (DTV/DVD)
- 8 COMPONENT2 Audio Input (DTV/DVD)
- 9 EURO-SCART1 Jack
- 10 EURO-SCART2 Jack
- 11 Antenna Input Jack

Remote Control

- 1 Power On/Off Button
- 2 Numeric Buttons
- 3 One/Two-Digit Channel Selection
- 4 Favorite Channel Selection (See page 24)
- 5 Picture Still (See page 26)
- 6 Sleep Timer (See page 21)
- 7 Picture Mode Selection (P.MODE) (See page 19)
- 8 Sound Mode Selection (S.MODE) (See page 20)
- 9 Control the Cursor in the OSD Menu ▲ (▲) and ▼ (▼) (Channel Up / Down) (Teletext Page Up / Down, Page 29) ◀ and ▶ (Volume Up / Down)
- 10 MENU Confirmation
- 11 Display OSD Menu
- 12 PIP Functions: (See page 25 ~ 26)
 - PIP On/Off (PIP)
 - Position Selection (POSITION)
 - Size Selection (SIZE)
 - Selecting the Input Source (TV/AV)
 - Swapping main and sub picture (P.SWAP)
 - Swapping main and sub Sound (S.SWAP)
 - Channel Up (CH+)
 - Channel Down (CH-)

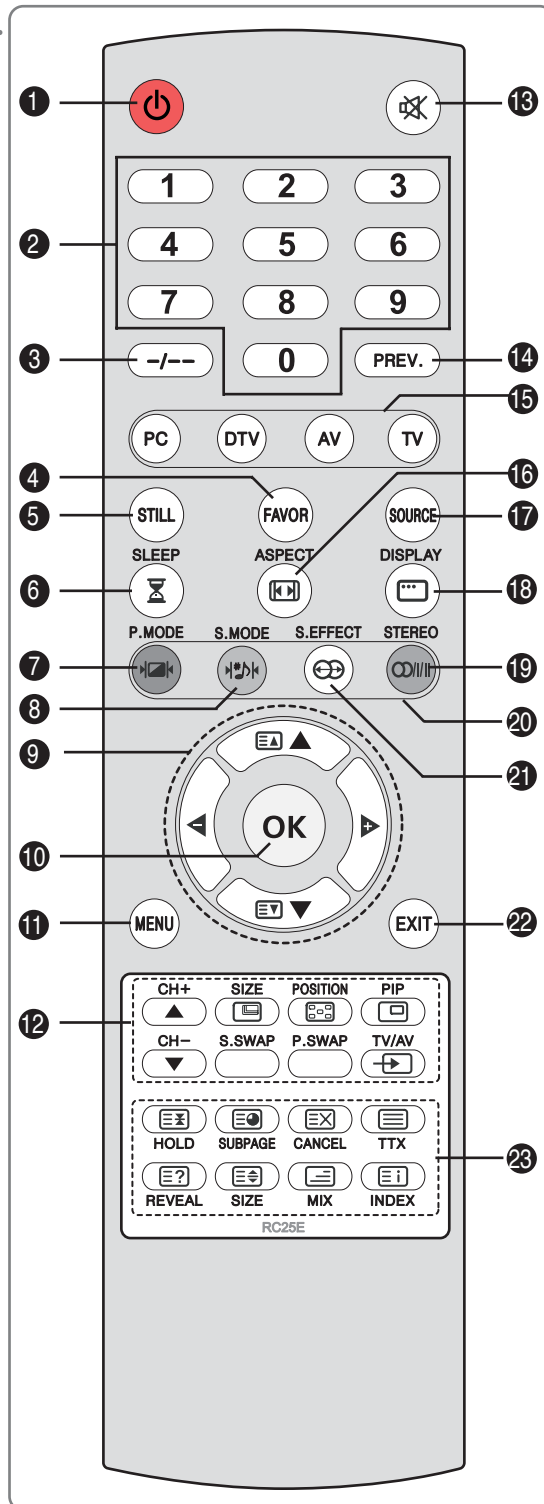

- 13 Temporary Sound Mute
- 14 TV Input Source Selection (See page 17)
- 15 External Source Input Selection (See page 15)
- 16 Picture Size Selection (See page 27)
- 17 Source Input Selection
- 18 TV Information Display (See page 22)
- 19 Sound Selection : Mono/Stereo/Dual Select (STEREO) (See page 22)
- 20 Fastext Functions : (See page 28)
- 21 Sound Effect Selection (S.EFFECT) (See page 22)
- 22 -Exit from the OSD
-Display the current time when the OSD is off (See page 21)
- 23 Functions : (See page 29)
 - Teletext On/Off (TTX)
 - Cancel (CANCEL)
 - Sub Page On (SUBPAGE)
 - Page Hold (HOLD)
 - Index (INDEX)
 - Mix (MIX)
 - Size (SIZE)
 - Reveal (REVEAL)

- - Makes sure there are no objects between the remote control and its sensor.
- Don't place the remote control near a heater or in damp place.
- A strong blow to the remote control may cause it not to operate.

Inserting Batteries in the Remote Control

You must insert or replace the batteries in the remote control when you purchase the TV or when you find that the remote control is no longer operating correctly.

- 1 Insert two AAA-size batteries (supplied) by matching the + and - on the batteries to the diagram inside the battery compartment.
 - Handle the remote control with care; avoid dropping it, getting it wet, placing it direct sunlight, near a heater, or where the humidity is high .
 - Remove the batteries to avoid damage from possible battery leakage whenever you anticipate that the remote control will not be used for an extended period.

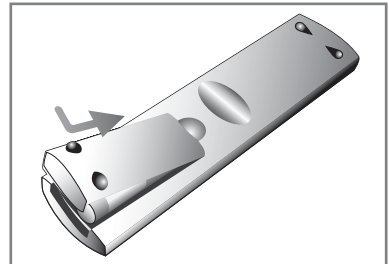
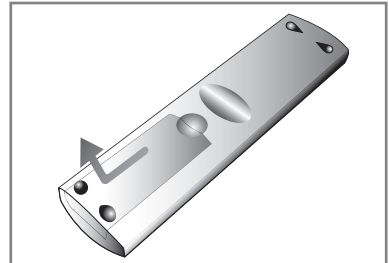

Connecting an Antenna or Cable

To view television channels correctly, a signal must be received by the set from one of the following sources: an outdoor antenna, a cable television system or a satellite dish.

- 1 Connect the antenna or input cable to the 75 Ω coaxial input on the rear of the TV.
- 2 If you are using an indoor antenna, you may need to turn it when tuning your television until you receive a clear picture.

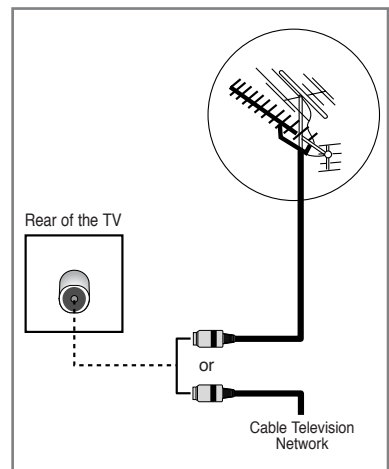

Connecting to the RCA or S-Video Input (Side AV2)

Right Side of the TV



(A) For RCA Input

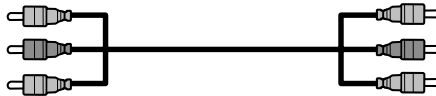

(B) For S-Video Input

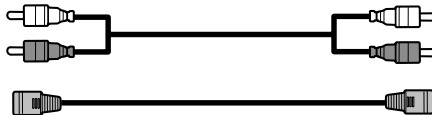

VCR



Camcorder

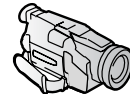

Video game device



(A) For RCA Input

1. Connect the RCA cable to the input jacks (video+ audio L/R of side AV2) on the TV and output jacks on the external equipment such as a VCR, camcorder and some video game devices.

(B) For S-Video Input

1. Connect the S-Video/RCA (audio L/R of side AV2) cable to the input jacks on the TV and output jacks on the external equipment such as a VCR, camcorder and some video game devices.
2. If the external equipment has mono audio output, connect it only to left jack of the Audio Input/Output.

Connecting to the SCART Input

Rear of the TV

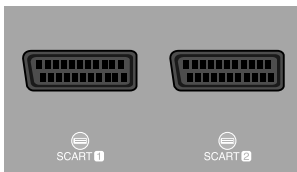

(A) SCART to SCART connector

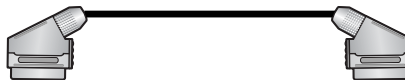

(B) SCART to RCA connectors
(Video + Audio L/R)



DVD/DTV STB



VCR



Satellite Receiver



Camcorder



Video game device



- The SCART1 or SCART2 connector is used for external equipment with RGB output, such as a VCR, satellite receiver, camcorder, or video game devices.
 - SCART1 : Full SCART (CVBS & RGB input/output)
 - SCART2 : Half SCART (CVBS only input/output)
- You can select and set one between the two types of cables (A, B) appropriate for the output jack of external device.

Connecting to a DVD or DTV Set-Top Box INPUT (RCA or DVI)

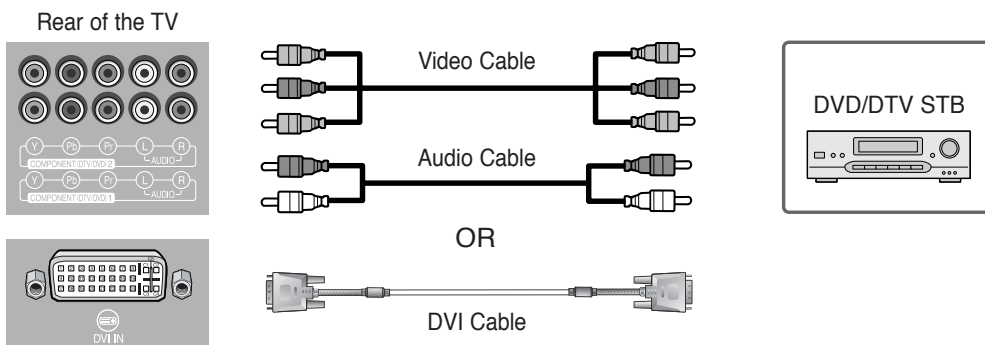

1. Connect the video cables to the Y, Pb, Pr input jacks (COMPONENT1 or 2) on the TV and the Y, Pb, Pr output jacks on the DVD or DTV Set-Top Box.
 2. Connect the audio cables to the Audio L/R input jacks (COMPONENT1 or 2) on the TV and the Audio output jacks on the DVD or DTV Set-Top Box.
-
1. Connect the DVI cables to the DVI input jacks (DVI) on the TV and the DVI output jacks on the DVD or PC.
 2. Connect the audio cables to the Audio L/R input jacks on the TV and the Audio output jacks on the DVD or PC.

Supported Signal for Component Ports

	480i / 60Hz	480p / 60Hz	576i / 50Hz	576p / 50Hz	720p / 50Hz	720p / 60Hz	1080i / 60Hz
COMPONENT 1	O	O	O	O	O	O	O
COMPONENT 2	O	O	O	O	O	O	O

Connecting the Headphones

Right Side of the TV

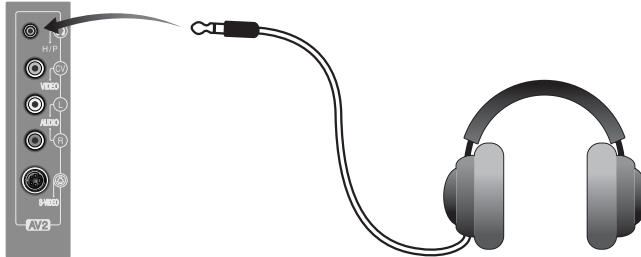

You can connect a set of headphones to your TV if you wish to watch a program without disturbing the other people.

1. Plug a set of headphones into the 3.5mm mini-jack socket on the right side of your TV. You can be heard the sound through the headphones.

Note : • If you use headphones for long period of time at a high volume, you may damage your hearing.

- Headphones are not included.

Connecting the Power Cord and Switching the TV On / Off

- 1 Connect the power cord for your TV to the power inlet on the back of your TV.
- 2 Plug the power cord for the TV into a nearby outlet, and turn on the power switch on the back of your TV.
- 3 Press the **POWER**, **CH** button on the front panel of your set or press the **POWER** (⏻), **CHANNEL** (▲▼), **Number** (0~9) button on the remote control.
After the green LED lamp switch on and your TV will be turned on.
- 4 To switch your TV off, press the **POWER** (⏻) button again.



Selecting a Picture from External Sources

After your various systems (audio and video) have finished, you can view any of the sources by selecting the appropriate external input.

- 1 Make sure all the necessary connections have been made.
- 2 Press the **POWER** (⏻) button to switch the TV on.
- 3 Select the favorite source by pressing the **SOURCE** (SOURCE) button one or more times.
 - The Input Source (SOURCE) is displayed in following order :
TV → SCART1 → SCART2 → AV2 VIDEO → AV2 S-VIDEO → COMPONENT1 → COMPONENT2 → DVI → PC
 - The Video (AV) is displayed in the following order :
SCART1 → SCART2 → AV2 VIDEO → AV2 S-VIDEO

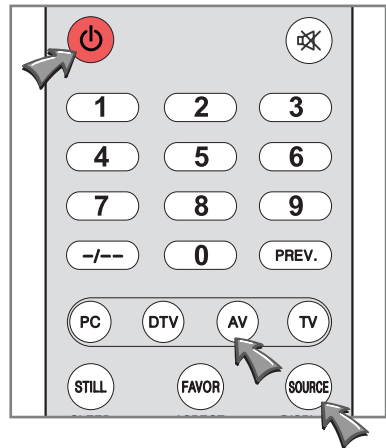

Selecting your Language

When you start using your TV for the first time, you must select the language in which to display all on-screen menus.





- 1 Press the **MENU** (MENU) button.
- 2 Press the (◀▶) button to select **SET UP** group and press the **OK** button.
- 3 Press the (▲▼) button to select **LANGUAGE**. Then press the **OK** or (▶) button
- 4 Select the appropriate language by pressing the (▲▼) button and then press the **OK** button.
 - You can select **ENGLISH, FRANÇAIS, DEUTSCH, ITALIANO, CASTELLANO, or NEDERLANDS, OTHERS.**
- 5 Press the **MENU** button to return to the previous menu.

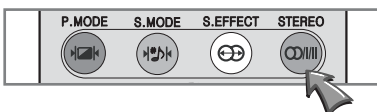
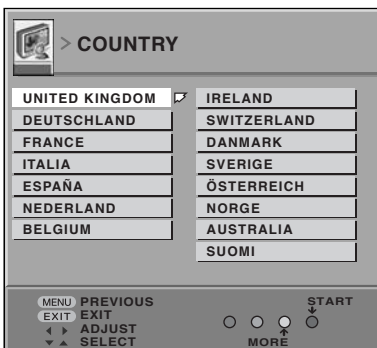
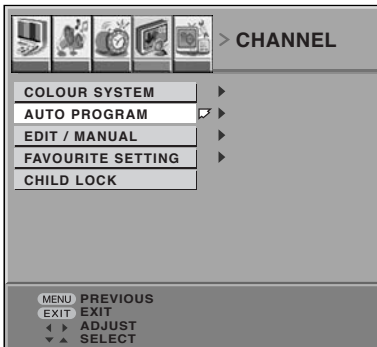
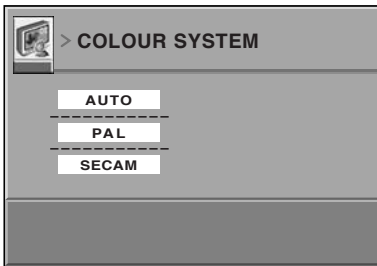
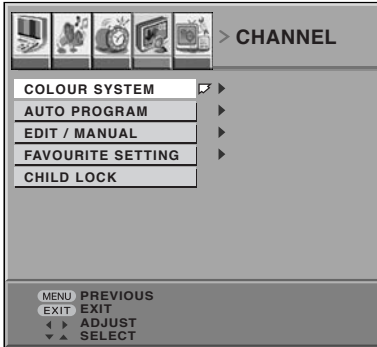

Storing Channels in Memory



COLOUR SYSTEM





- 1 Press the **MENU**() button.
- 2 Press the () button to select **CHANNEL** group and press the **OK** button.
- 3 Press the () button to select **COLOUR SYSTEM**. Then press the **OK** or () button. The sub-menu of the COLOUR SYSTEM function appears.
- 4 Press the () button to select the appropriate colour system. Then press the **OK** button.

- You can change the colour system of the main-picture.

- **PAL** : PAL system
- **SECAM** : SECAM system
- **AUTO** : This function detects a colour system from the input signal. You can only use this when you are viewing a picture from programme number PR 0 (AV), or an EXT terminal.

- The colour system is chosen automatically. However, if the picture is not clear or no colour appears, choose the colour system manually.

AUTO PROGRAM

- 1 Press the () button to select **AUTO PROGRAM**. Then press the **OK** or () button
- 2 Press the () button to select **COUNTRY**, then press the **START**() button for about 3 seconds.

You can select the countries in following order.

UNITED KINGDOM → DEUTSCHLAND → FRANCE → ITALIA → ESPAÑA → NEDERLAND → BELGIUM → AUSTRALIA → SWITZERLAND → DANMARK → SVERIGE → ÖSTERREICH → NORGE → SUOMI → Other

- You can stop the Auto tuning by pressing the **EXIT**() button during auto tuning.



- You can again perform the AUTO PROGRAM function TV channel automatic registration which was performed in the "Initial settings"

Storing Channels in Memory

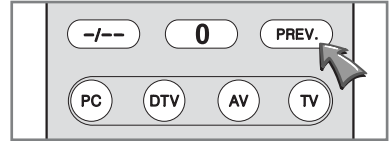
Press the **PREV.** () button to swap programs you select with each other.



EDIT / MANUAL

- 1 Press the () button to select **EDIT / MANUAL**. then press the **OK** or () button. The EDIT menu appears.
- 2 Follow the description for the function you want to use, press the a button to complete the settings.

The **EDIT / MANUAL** functions are divided into two types:

- Editing the current programme numbers (PR) (EDIT functions); and
 - Manually storing a TV channel you want to view on a particular programme number (PR) (MANUAL function).
- Here are the details about these functions:



MOVE : This function changes the programme number (PR) of a TV channel.

ID () : This function registers a channel name (ID) to a TV channel.

INSERT () : This function adds a new TV channel in the current programme numbers (PR) list by using the CH / CC number.
-You cannot use the INSERT function if you do not know the channel number of a TV channel. Use the MANUAL function to register a TV channel in the programme number(PR).

DELETE () : This function deletes a TV channel you do not want to list.

MANUAL () : This function manually stores a new TV channel in a programme number (PR).



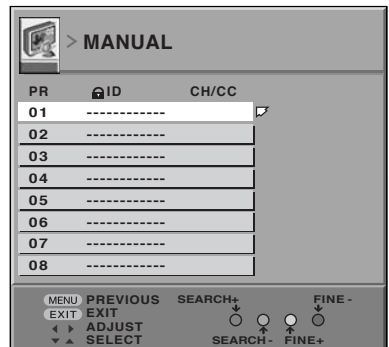
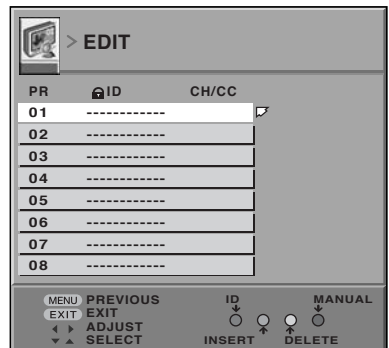
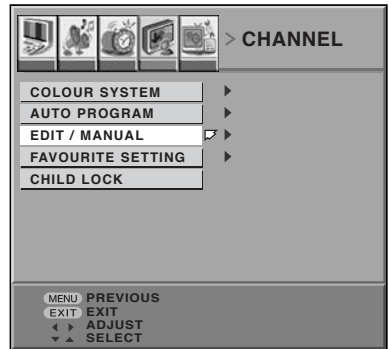



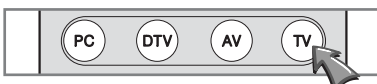
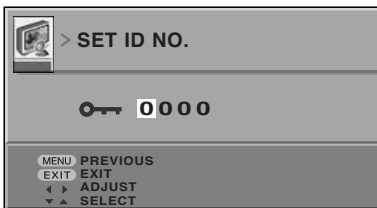
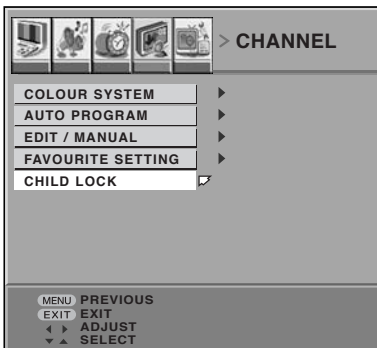
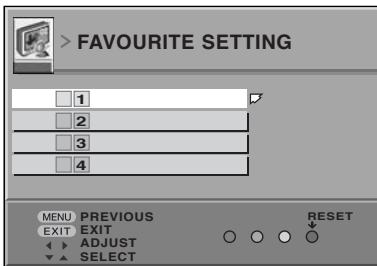
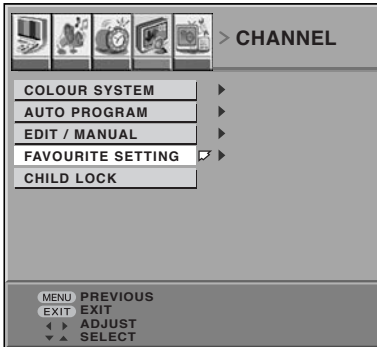

- Press the () buttons to select “**CH**” or “**CC**”, then enter the remaining **CH** or **CC** number.
- When a TV channel has already been registered in PR 99, using the INSERT function deletes that TV channel.
- Press the **MANUAL** () button to activate the MANUAL function. At the right side following the CH/CC number, the SYSTEM (broadcasting system) of the TV channel appears.















Storing Channels in Memory







FAVOURITE SETTING

- 1 Press the **MENU**() button.
- 2 Press the ( ) button to select **CHANNEL** group and press the **OK** button.
- 3 Press the ( ) button to select **FAVOURITE SETTING**. then press the **OK** or () button. The **FAVOURITE SETTING** menu appears.
- 4 Press the ( ) buttons and select the favourite channel that you want to delete.
- 5 Press the **RESET**() button : The chosen favourite channel and set contents are deleted.
 - For details of the favourite channels, see "Favourite channel function" on page 24.

CHILD LOCK

- 1 Press the **MENU**() button.
- 2 Press the ( ) button to select **CHANNEL** group and press the **OK** button.
- 3 Press the ( ) button to select **CHILD LOCK**, then press the () button.
- 4 "**SET ID NO.**" (ID number setting screen) appears. Press the ( ) button to select a number. Press the ( ) button to move the cursor.
 - When there is a TV channel you do not want your children to watch, you can use the **CHILD LOCK** function to lock out the TV channel. Even when a child chooses a programme number (**PR**) for a locked TV channel the screen will change to blue and display  (**CHILD LOCK**) so the TV channel cannot be viewed. Unless you enter a pre-set **ID** number by a special operation, the lock cannot be released and the child cannot view the TV channel.
 - If you have forgotten the ID number: Perform step 1 of "To set the CHILD LOCK function". After confirming the ID number, press the **TV**() button to exit the menu.
 - Even if you reset the lock temporarily, it does not mean that the **CHILD LOCK** function set for the TV channel is cancelled. The next time anyone tries to view the TV channel, it will be locked again.
 - When you want to cancel the **CHILD LOCK** function, you must perform the operation "To set the CHILD LOCK function" again.

Customizing the Picture

- 1 Press the **MENU**() button.
- 2 Press the () button to select **PICTURE** group and press the **OK** button.
- 3 Press the () button to select **PICTURE MODE** then press the **OK** or () button.

- You can select one of three **PICTURE MODEs** to adjust the picture settings automatically.



STANDARD : Standardizes picture adjustment.
SOFT : Softens contrast and sharpness.
BRIGHT : Heightens contrast and sharpness.

- ☛ You can get the same result by pressing the () button on the remote control.

- 4 Press the () button to move to the menu that you wish to adjust.

BLACK LEVEL : Adjusts the black level the contrast of picture.
 The dark regions of the picture are made darker, while bright area remains unchanged.

CONTRAST : Adjusts the clarity of the whole screen.
BRIGHTNESS : Adjusts the brightness of the whole screen.
SHARP : Corrects the contours of the image.
COLOUR : Adjusts the colour saturation of the image.
HUE : Adjusts the colours of the image.

- 5 Press the () button to select **COLOUR TEMP.** then press the **OK** or () button.



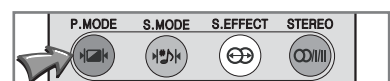
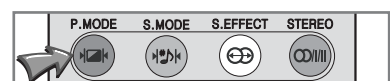
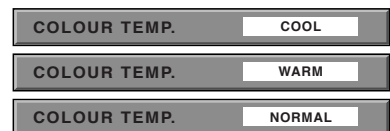
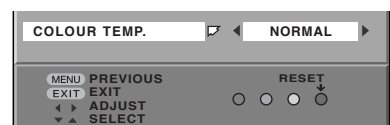
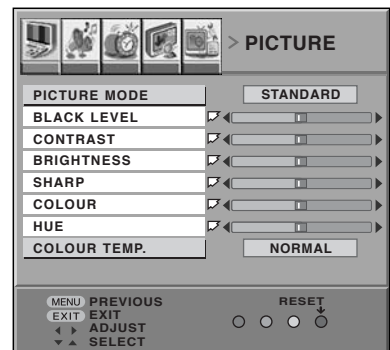
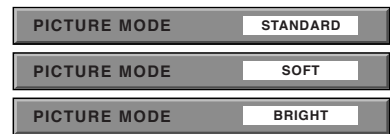
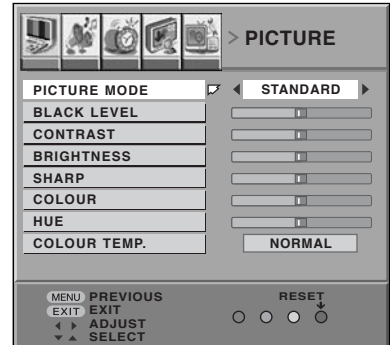

- You can select one of three **COLOUR TEMP.** modes (three tones of white) to adjust the white balance of the picture. Since white is the colour which is used as a reference for all the other colours, changing the **COLOUR TEMP.** mode affects the appearance of all the other colours on the screen.

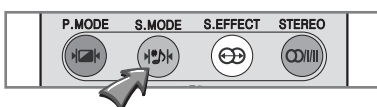
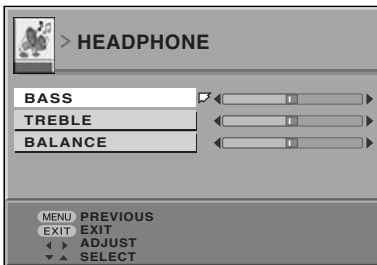
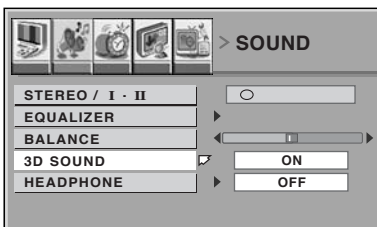
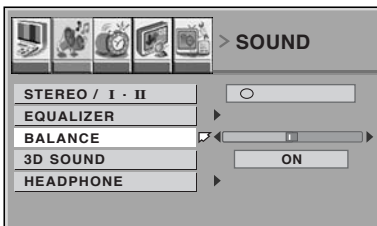
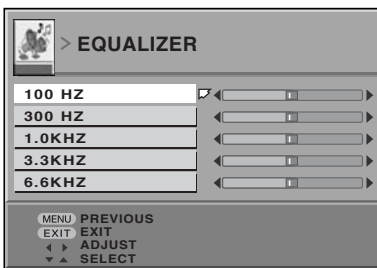
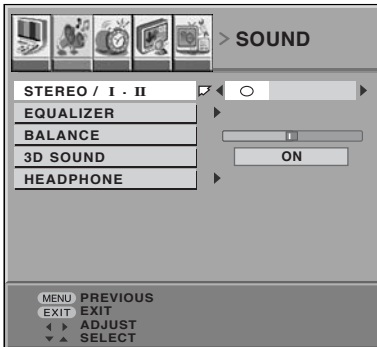

COOL : A bluish white. Using this mode when watching bright pictures allows you to enjoy a more vivid and bright picture.
WARM : A reddish white. Using this mode when watching films allows you to enjoy colours that are characteristic of films.
NORMAL : The normal white colour.



Customizing the Sound





- 1 Press the **MENU**() button.
- 2 Press the () button to select **SOUND** group and press the **OK** button.
- 3 Press the () button to select **STEREO / I · II** then press the **OK** or () button.

Adjust the **STEREO / I · II** with () or () button you wished.

- When you are viewing a bilingual broadcast programme, you can select the sound from Bilingual I (Sub I) or Bilingual II (Sub II). If you have poor reception on a stereo broadcast, you can change from stereo to mono sound so that you can hear the broadcast more clearly and easily.



○ : mono sound →  : Stereo sound → **I** : Bilingual I (sub I) → **II** : Bilingual II (sub II)



- 4 Press the () button to select **EQUALIZER** then press the **OK** or () button.



Adjust the frequency with () or () button you wished.

100HZ → 300HZ → 1.0KHZ → 3.3KHZ → 6.6KHZ

- ☛ You can get the same result by pressing the () button on the remote control.
- ☛ If you adjust the frequency (100Hz, 300Hz, 1KHz, 3.3KHz, 6.6KHz) in Standard, Music, Film or Speech mode, the mode will be changed to Custom mode.



- 5 Press the () button to select **BALANCE** then press the **OK** or () button.

Adjust the sound balance with () or () button you wished.

- 6 Press the () button to select **3D SOUND** then press the **OK** or () button.

Adjust the 3D sound with () or () button you wished.

- You can enjoy Surround sound with a "live" effect by using the 3D SOUND function.
- You can select a 3D SOUND mode from ON or OFF modes.

- 7 Press the () button to select **HEADPHONE** then press the **OK** or () button.

Press the () button to select the three modes.

BASS : You can adjust the low tone of the sound.

TREBLE : You can adjust the high tone of the sound.

BALANCE : You can adjust the volume balance between the left and right headphone.

Adjust the sound volume with () or () button you wished.

Setting the Date & Time

- This function is available after you set the clock first.
- Press the (EXIT) button on the remote control to display the current time.

- 1 Press the MENU(MENU) button.
- 2 Press the (◀▶) button to select **TIME** group and press the OK button.
- 3 Press the (▲▼) button to select **TIME** then press the OK or (▶) button.
Press the (◀▶) button to set the current time adjust the current time with (▲▼) button.
- 4 Press the (▲▼) button to select **ON TIME** then press the OK or (▶) button.
Press the (◀▶) button to set on time. Adjust the on time with (▲▼) button.
Press the (◀▶) button to select ON or OFF.
- 5 Press the (▲▼) button to select **OFF TIME** then press the OK or (▶) button.
Press the (◀▶) button to set off time. Adjust the off time with (▲▼) button.
Press the (◀▶) button to select ON or OFF.
- 6 Press the (▲▼) button to select **SLEEP TIMER** then press the OK or (▶) button.
A Sub-menu of the **SLEEP TIMER** function appears.
 - You can set the TV to automatically turn off after a set period of time.
 - You can set the period of time for up to 120 minutes (2 hours) in 10 minute steps.
 - When the SLEEP TIMER function is on, you can display the sub-menu of the SLEEP TIMER function again to confirm or change the remaining period of time of the SLEEP TIMER function. Press the OK button to leave the menu after confirming or changing the remaining time.
 - You can get the same result by pressing the (SLEEP) button on the remote control.
- 7 Press the (▲▼) button to select **ON TIME VOL.** then press the OK or (▶) button.
Press the (◀▶) button to set on time volume. Adjust the on time volume with (▲▼) button.
- 8 Press the (▲▼) button to select **ON TIME CH** then press the OK or (▶) button.
Press the (◀▶) button to set on time channel. Adjust the on time channel with (▲▼) button.

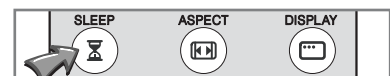
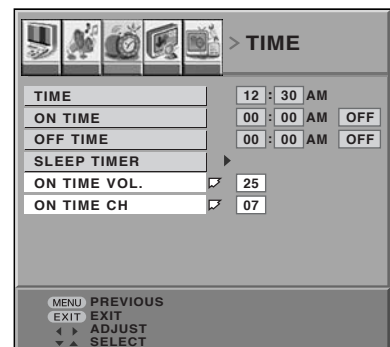
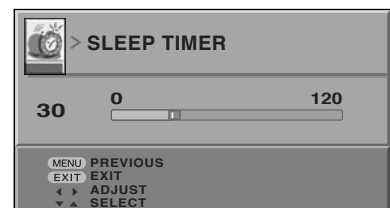
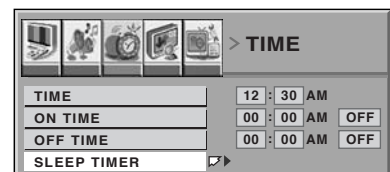
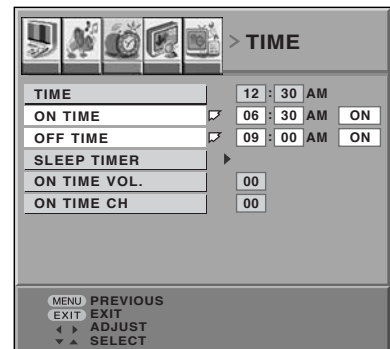
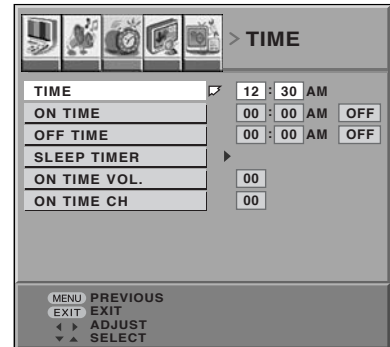

3D SOUND function

- You can enjoy sounds with a wider ambience.
- This function does not work for the sound from headphones.

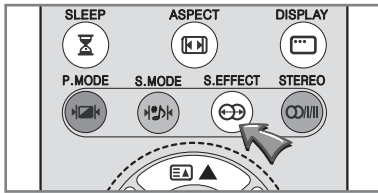

- 1 Press the () button to select one of **3D SOUND** modes.
- 2 When you listen to stereo sound, please select **ON** or **OFF** mode. You can enjoy sound similar to the experience at the theatre.
 - ON** : Select the ON mode, when you listen to the mono sound. You can enjoy the sound for a wider audience similar to stereo sound.
 - OFF** : The 3D SOUND function switches off.

Listening to Stereo Sound / Dual Sound

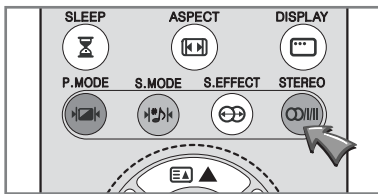

Listening to Stereo Sound



- 1 Press the () button on the remote control to select Mono or Stereo.
 - Mono or Stereo be will selected in turn whenever you press the button.
 - ☛ Select Mono sound when you have difficulty with stereo sound.

Listening to the Dual Sound

- 1 Press the () button on the remote control to select Dual sound.
 - Dual 1: Your national language.
 - Dual 2: Foreign language will be selected by turn whenever you press the button.

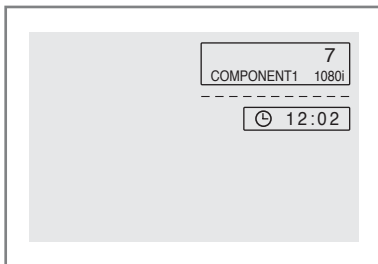
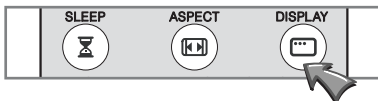
Displaying the TV Information









- 1 Press the () button on the remote control to display the current channel, time. If you press this () button again, the information disappear.
 - 7** : Current Channel.
 - PM 12:02** : Current Time (When the time is not set, --:-- is displayed).

PC SET UP

This function does not work in DVI-Digital mode.



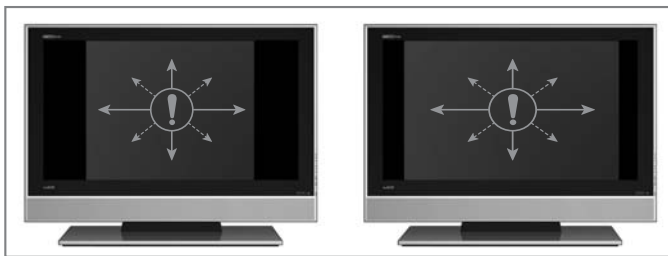

Auto Adjusting

- 1 Press the **MENU**() button.
- 2 Press the () button to select **SET UP** group and press the **OK** button.
- 3 Press the () () button to select **PC SET UP** then press the **OK** or () button. A Sub-menu of the **PC SET UP** function appears.
- 4 Press the () () button to select **AUTO ADJUST** and press the **OK** button.

After then the screen will be automatical position and size setup.







Adjusting the horizontal position

- 1 Press the () () button to select **H-POSITION**.
- 2 Move the PC screen to the right or left by pressing the () () button.



Adjusting the vertical position

- 1 Press the () () button to select **V-POSITION**.
- 2 Move the PC screen up or down by pressing the () () button

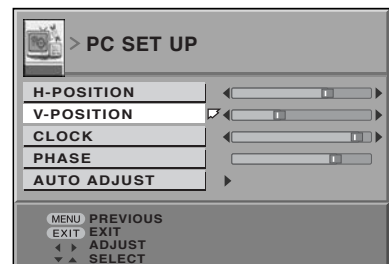
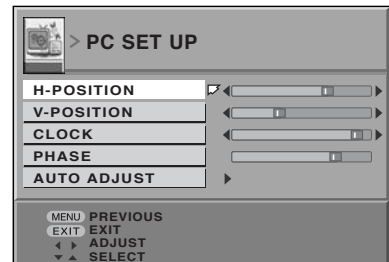
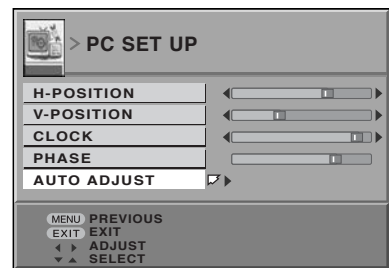
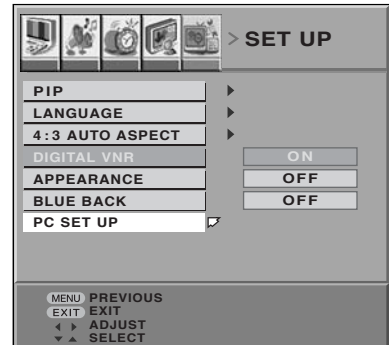

PC SET UP

This function does not work in DVI-Digital mode.

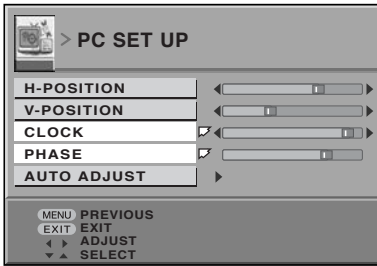

Adjusting the clock

- 1 Press the **MENU** (MENU) button.
- 2 Press the (◀▶) button to select **SET UP** group and press the **OK** button.
- 3 Press the (▲▼) button to select **PC SET UP** then press the **OK** or (▶) button. A Sub-menu of the **PC SET UP** function appears.
- 4 Press the (▲▼) button to select **CLOCK**.
- 5 Adjust the clock value with (◀) or (▶) button you wished.

Adjusting the phase

- 1 Press the (▲▼) button to select **PHASE**.
- 2 Adjust the phase value with (◀) or (▶) button you wished.

Favourite channel function

Chose when deleting the favourite channels registered in the buttons 1 to 4.

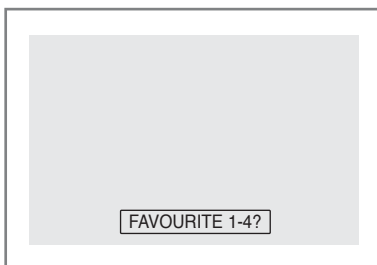
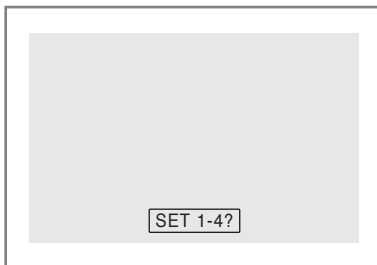
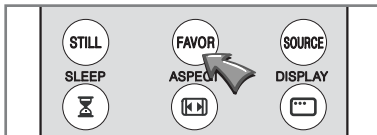

Favourite channel registration

You can register your favourite TV channels (PR 1 - PR 99) in the number buttons 1 to 4. After registering, the channel can be called by pressing the **favourite** (FAVOR) button and a number button 1 to 4.

- 1 In the normal screen, choose a TV channel (PR 1 – PR 99) that you want to register.
- 2 Press and hold the **favourite** (FAVOR) button for three seconds or more. Then “SET 1-4?” appears on the screen.
- 3 Press one of the number buttons 1 to 4 :
The current channel is registered in the pressed number button. After “PROGRAMMED!” appears on the screen, the favourite channel icon appears at the top-right of the screen.
 - If the channel you are trying to register is already registered in one of the other number buttons 1 to 4, “NOT AVAILABLE” appears on the screen.
 - Channels locked with the CHILD LOCK function cannot be registered.
 - If AUTO PROGRAM is performed, the registered favourite channels are reset.

Calling the favourite channel

- 1 In the normal screen, press the **favourite** (FAVOR) button. Then “FAVOURITE 1-4” appears.
- 2 Press one of the number buttons 1 to 4. The called favourite channel appears on the screen.
 - If a number button in which no channel is registered is pressed, “NO MEMORY” appears on the screen.

Display the Picture in Picture (PIP)

- This function is available only with the remote control.
- You can watch another device's image in the PIP while watching the TV, PC or in VIDEO the main image.



- Press the **PIP** () button.
There are 2 modes of PIP window : **SMALL, LARGE**
Whenever you press this button, PIP window mode will be changed.
The PIP window is changed in the following order :
SMALL → LARGE → OFF



< SMALL >



< LARGE >

- Press the **TV/AV** () button to select the external signal source for the PIP.
 - The external signal source will display whenever you press the **TV/AV** () button.
(**COMPONENT1 → COMPONENT2 → DVI → PC**)
 - ☛ You can change the main picture channel by pressing the () button.

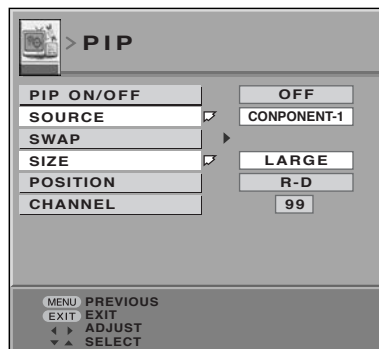
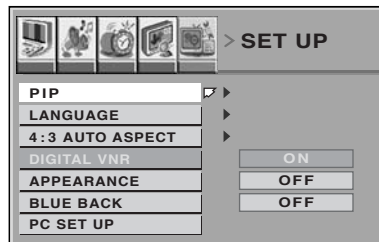
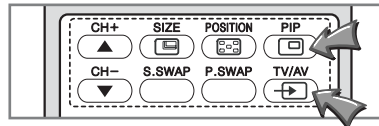

PIP		Main	PIP	TV	AV	S-VHS	SCART1/2	COMPONENT 1	COMPONENT 2	PC	DVI
										ANALOG	DIGITAL
	TV		X	O	O	O	O	O	O	O	O
	AV		O	X	X	X	O	O	O	O	O
	S-VHS		O	X	X	X	O	O	O	O	O
	SCART 1/2		O	X	X	X	O	O	O	O	O
	COMPONENT 1		O	O	O	O	X	X	X	X	X
	COMPONENT 2		O	O	O	O	X	X	X	X	X
	PC	ANALOG	O	O	O	O	X	X	X	X	X
	DVI	DIGITAL	O	O	O	O	X	X	X	X	X

Changing the PIP Position

- Press the **POSITION** () button on the remote control.
 - The PIP position will change among 4 positions whenever you press this button.

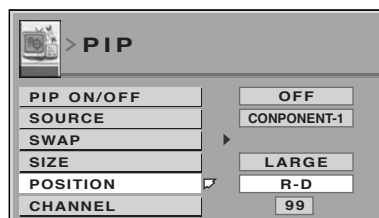
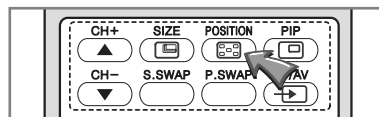
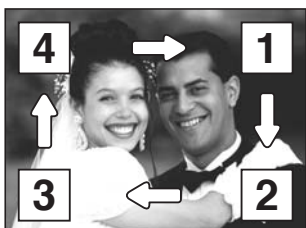

Display the Picture in Picture (PIP)

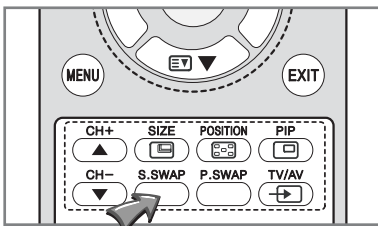
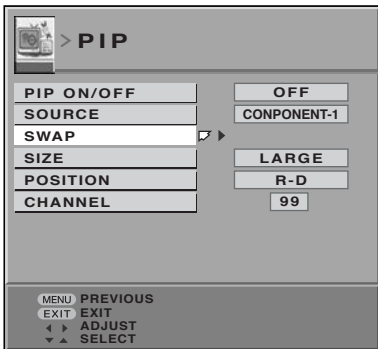
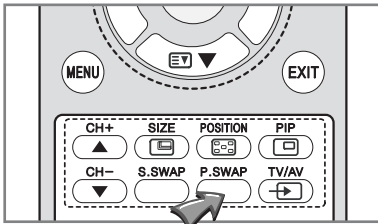
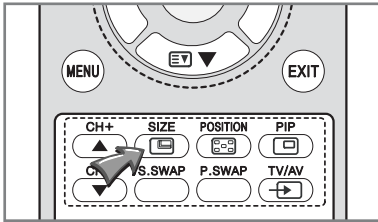

Changing the PIP Size

- 1 Press the () button on the remote control.
 - The PIP will change among 2 different sizes whenever you press this button.



Swapping the Main & Sub-Picture

- 1 Press the () button on the remote control.
 - The Main image and PIP image will switch with each other whenever you press this button.



Swapping the Main & Sub-Sound

- 1 Press the () button on the remote control.
 - The Main sound and PIP sound will switch with each other Whenever you press this button.

Display a Still Image

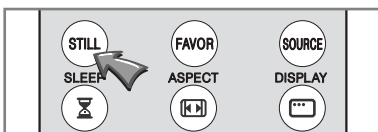









- 1 Press the **Still** () button on the remote control.
 - The picture does not move but the sound plays normally.
 - Press this button again if you want to go back to a normal picture.

Changing the Picture Size

- You can change the screen size according to the picture aspect ratio. Choose the optimum one from the following ASPECT modes.
- The AUTO ASPECT mode is fixed at FULL when you are using the TV as a PC screen.

Setup your Auto Aspect

- 1 Press the **MENU**() button.
- 2 Press the ( ) button to select **SET UP** group and press the **OK** button.
- 3 Press the ( ) button to select **4:3 AUTO ASPECT** then press the **OK** or () button.
A Sub-menu of the **4:3 AUTO ASPECT** function appears.
- 4 Press the ( ) button to select one of three modes.
PANORAMIC, REGULAR, 14:9 ZOOM
 - You can get the same result by pressing the () button on the remote control.
AUTO → REGULAR → PANORAMIC → 14:9 ZOOM → 16:9 ZOOM → 16:9 ZOOM SUBTITLE → FULL

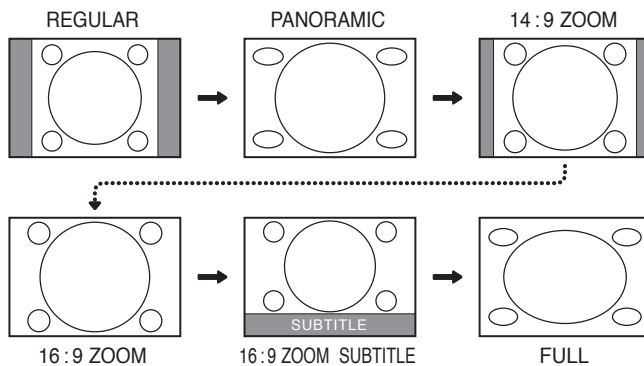

AUTO : When a WSS (Wide Screen Signalling) signal, which shows the aspect ratio of the picture, is included in the broadcast signal or the signal from an external device, the TV automatically changes the ZOOM mode to 16:9 ZOOM mode or FULL mode according to the WSS signal. If a WSS signal is not included, the picture is displayed according to the ZOOM mode set with the 4:3 AUTO ASPECT function.

REGULAR : Use to view a normal picture (4:3 aspect ratio) as this is its original shape.

PANORAMIC : This stretches the left and right sides of a normal picture (4:3 aspect ratio) to fill the screen, without making the picture appear unnatural. The top and bottom of the picture are slightly cut off.

14:9 ZOOM : This zooms up the wide picture (14:9 aspect ratio) to the upper and lower limits of the screen.

16:9 ZOOM : This zooms up the wide picture (16:9 aspect ratio) to the full screen.

16:9 ZOOM SUBTITLE : This zooms up the wide picture (16:9 aspect ratio) with subtitles to the full screen.

FULL : This uniformly stretches the left and right sides of a normal picture (4:3 aspect ratio) to fill the wide TV screen. For 16:9 aspect ratio pictures that have been squeezed into a normal picture (4:3 aspect ratio), use the FULL mode to restore the picture to its original shape.

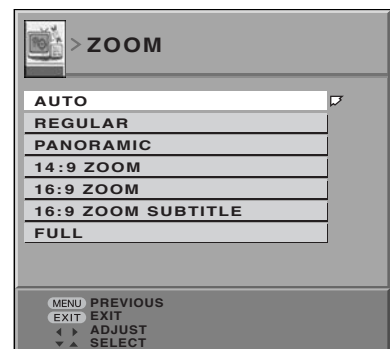
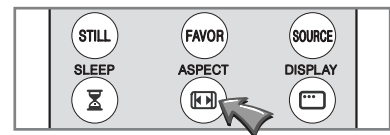
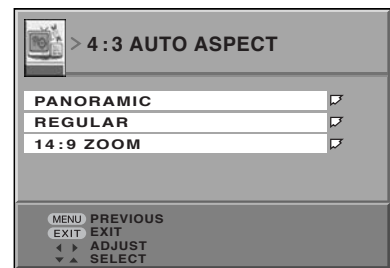
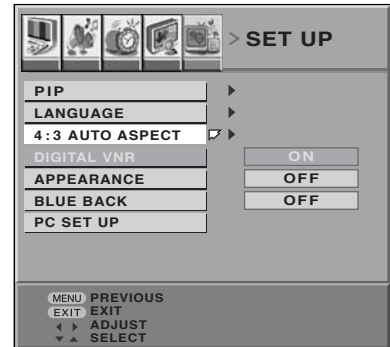



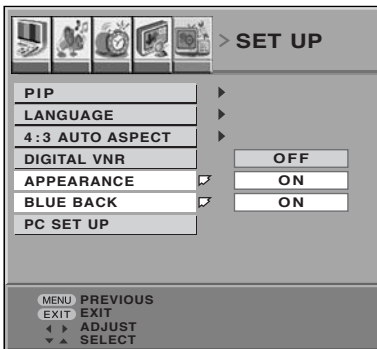
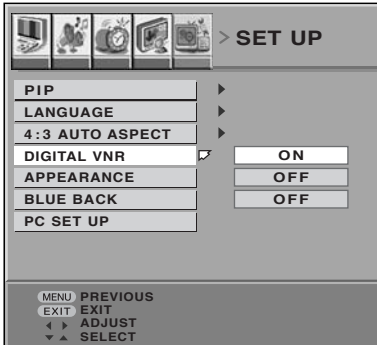



Noise & OSD Setting







Reducing picture noise (DIGITAL VNR)





Use this function when you have a bad image with the picture noise.

- 1 Press the **MENU**() button.
- 2 Press the () button to select **SET UP** group and press the **OK** button.
- 3 Press the () button to select **DIGITAL VNR** then press the **OK** or () button.
- 4 Adjust the digital VNR with () or () button you wished.
 - You can select a DIGITAL VNR mode from **ON** or **OFF** modes.
 - The DIGITAL VNR function cuts down the amount of 'noise' ('snow' or interference) in the original picture.

OSD Appearance

- 1 Press the () button to select **APPEARANCE** then press the **OK** or () button.
- 2 Adjust the appearance with () or () button you wished.
 - You can select a appearance mode from **ON** or **OFF** modes.
ON : OSD window screen transparency.
OFF : Screen behind the OSD window screen doesn't show up.

Changing the Blue Back Screen

- 1 Press the () button to select **BLUE BACK** then press the **OK** or () button.
- 2 Adjust the blue back with () or () button you wished.
 - You can select a blue back mode from **ON** or **OFF** modes.
 - You can set the TV to automatically change to a blue screen and mute the sound if the signal is weak or absent, or when there is no input from an external device.

Teletext Functions

The Teletext page of most TV channels provide information such as TV programme times, News bulletins, Weather forecasts, Travel information, or Sports results.

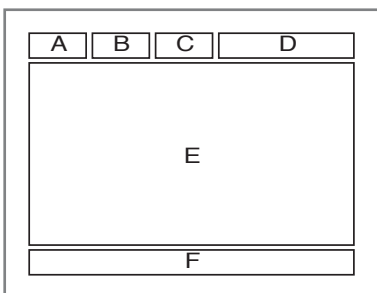

Functions of the teletext

Part	Display Contents
A	Selected page number.
B	Broadcast Station identity.
C	Current page number or searching status.
D	Date and time.
E	Text information.
F	FASTEXT information. Red, Green, Yellow, Cyan

Displaying the Teletext Information

- 1 Select the channel providing the teletext service using the (E▲) or (E▼) button.
- 2 Press the **TEXT** (TTX) button to activate the teletext mode. The contents of page 250 are displayed.
- 3 To display the index page, press the **INDEX** (INDEX) button.
- 4 To display the teletext page simultaneously with the actual broadcast, press the **MIX** (MIX) button.
- 5 To return to normal viewing press the **CANCEL** (CANCEL) button. "???" (specific characters) is displayed at the upper left until the new screen is selected.
- 6 To exit from the teletext mode, press the **TEXT** (TTX) button again.

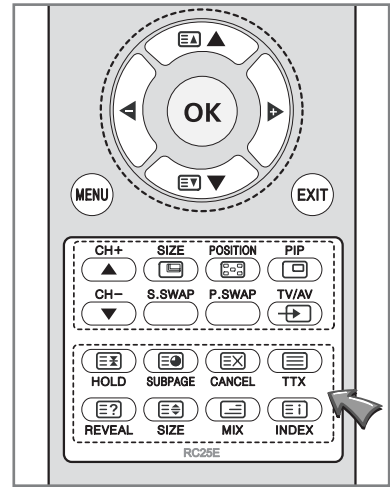

Selecting a Special Teletext Functions

Selecting a Special Teletext Functions

MENU	Functions
REVEAL REVEAL (E?)	Displays concealed text such as answer to quiz games. To return to normal viewing, press this button again.
SUB-PAGE SUBPAGE (E)	Displays a secondary page by entering its number.
PAGE UP (E▲)	Displays the next page.
PAGE DOWN (E▼)	Displays the previous page.
HOLD HOLD (E×)	When the secondary pages are displayed in sequence, press the HOLD button. To freeze the current display page, press the HOLD button again to resume.
SIZE SIZE (E)	Whenever you press this button, the letter size of the page will be changed. Once press : The letter of the top half page enlarge to double size. Twice press : The letter of the bottom half page enlarge to double size. Three times press : Return to the normal viewing.

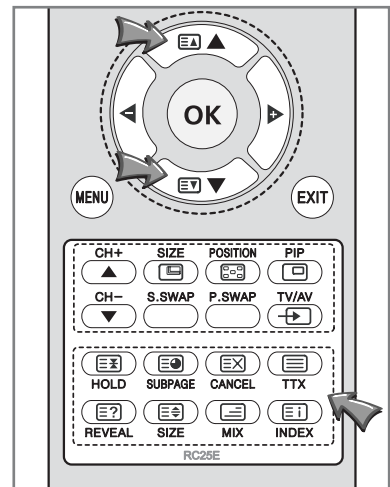

Connecting to the PC (DVI)

DVI INPUT

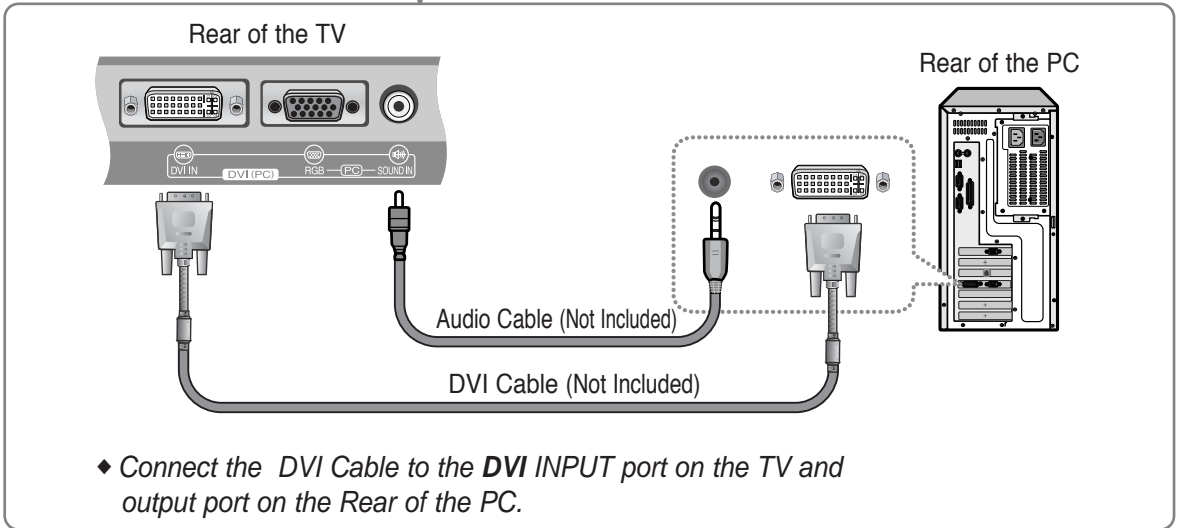

RGB INPUT

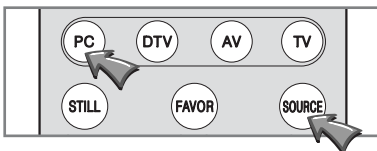
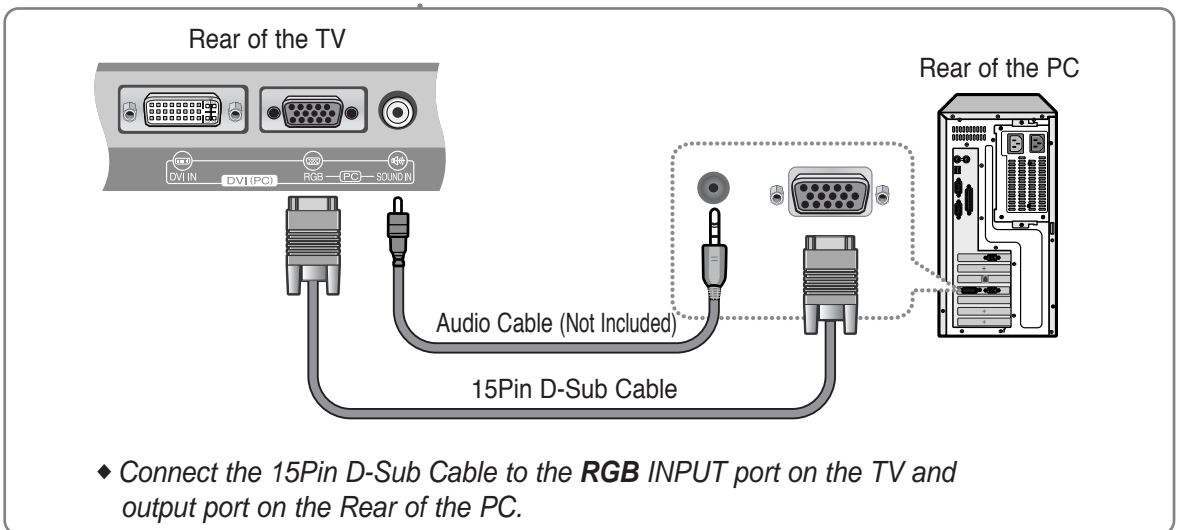

To use the TV as a PC Display

- 1 Turn the PC on.
- 2 Press the **PC** or (**SOURCE**) button on the remote control to select the PC.
- 3 Set up the PC software. (See page 31)
- 4 Adjust the screen in PC Mode. (See page 23 ~ 24)

- 1 First, click on **Settings** on the Windows **Start** menu and click on "**Control Panel**".
- 2 Double click on the **Display** icon.
- 3 Click on the **Settings** tab on the display dialog-box.
- 4 Adjust the resolution up to **1366 x 768** pixels.
- 5 Click the **Advanced** button and click the **Monitor** tab on the dialog-box. Set the vertical-frequency to **60Hz** and then click the **OK** button.

- ☛ - Maximum resolution depends on the Video Card.
- Maximum supported resolution is 1366 X 768 @ 75Hz , You can get the best picture at 1366 X 768@ 60Hz.
- There are 16,770,000 supported colours.

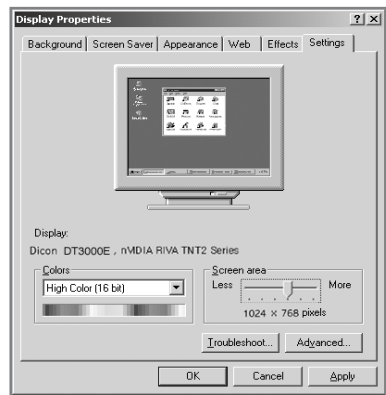

Standard Display Mode

If the signal from the system equals the standard signal mode, the screen will adjust automatically.
 If the signal from the system does not equal the standard signal, adjust the display mode as shown below referring to your video card instructions. Otherwise there will be no picture or only power may turn on.

Resolution	Horizontal (KHz)	Vertical (Hz)	Clock Frequency (MHz)	Polarity (H/V)
640 x 350	31.469	70.086	25.175	+ / -
720 x 400	31.469	70.087	28.322	- / +
VGA, 640 x 480	31.469	59.940	25.175	- / -
VGA, 640 x 480	37.500	75.000	31.500	- / -
VGA, 640 x 480	37.861	72.809	31.500	- / -
SVGA, 800 x 600	37.879	60.317	40.000	+ / +
SVGA, 800 x 600	46.875	75.000	49.500	+ / +
SVGA, 800 x 600	48.077	72.188	50.000	+ / +
XGA, 1024 x 768	48.363	60.004	65.000	- / -
XGA, 1024 x 768	56.476	70.069	75.000	- / -
XGA, 1024 x 768	60.023	75.029	78.750	+ / +
WXGA, 1280 x 768	60.023	75.029	78.750	+ / +
WXGA, 1366 x 768	60.023	75.029	78.750	+ / +

Pin Configuration

DVI-D Connector

Pin	Signal Assignment	Pin	Signal Assignment
1	T.M.D.S Data2-	13	T.M.D.S Data3+
2	T.M.D.S Data2+	14	+5V Power
3	T.M.D.S Data2/4 Shield	15	Ground(for +5V)
4	T.M.D.S Data4-	16	Hot Plug Detect
5	T.M.D.S Data4+	17	T.M.D.S Data0-
6	DDC Clock	18	T.M.D.S Data0+
7	DDC Data	19	T.M.D.S Data0/5 Shield
8	No Connect	20	T.M.D.S Data5-
9	T.M.D.S Data1-	21	T.M.D.S Data5+
10	T.M.D.S Data1+	22	T.M.D.S Clock Shield
11	T.M.D.S Data1/3 Shield	23	T.M.D.S Clock+
12	T.M.D.S Data3-	24	T.M.D.S Clock-

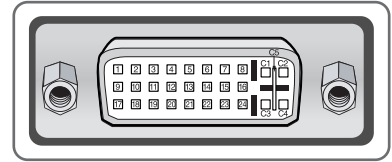

PC Input Connector (15Pin D-Sub)

Pin	PC IN
1	Red (R)
2	Green (G)
3	Blue (B)
4	Grounding
5	Grounding (DDC)
6	Red (R) Grounding
7	Green (G) Grounding
8	Blue (B) Grounding
9	Reserved
10	Sync Grounding
11	Grounding
12	Data (DDC)
13	Horizontal Sync
14	Vertical sync
15	Clock (DDC)

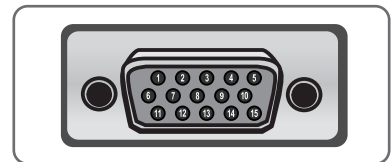

Troubleshooting

For TV

No picture or sound.

- Make sure the TV is plugged in.
- Make sure the power cord is connected to the consent correctly.
- Check the power failure.

Screen is black.

- Make sure the external signal source mode is selected.
- Press the **TV** button to change to TV.

Picture is OK but there is no sound.

- Press the **Mute** button.
- Check another channel.
- Press the button to increase the volume.

Poor sound quality.

- Make sure the channel using a stereo broadcast by pressing the Display () button.
- Select Mono. The sound quality of a stereo broadcast may be unstable in an area with a weak signal. (See page 22)

No image on a specific channel.

- Make sure the channel selection is correct.
- Change the antenna direction to the right or left.
- Adjust the fine tuning of the channel.

Image is not stable and may appear to vibrate , horizontal bars appear.

- Adjust the fine tuning of the channel.
- Make sure there is no powerful electromagnetic wave interference from the transmitting station.
- Stop using a hair drier, electric drill or electric blender.

No color on a specific channel (a black & white image).

- Check other channels to see if the specific channel is broadcasting a black & white program.
- Adjust the color. (See page 19)

Black or white dots appear on all channels or a specific channel.

- Make sure the antenna is connected correctly. (See page 11)
- Make sure the status of the antenna or wire is good .
- Adjust the fine tuning of the channel.

For Monitor

"No signal" message

- ☛ Check if the signal cable(DVI Cable) is properly connected to the computer. (See page 30)

"Out of range" message

- ☛ This message may appear when the resolution and frequency of the video card in the computer are out the range of the TV. Select the proper resolution and frequency for the TV. (See page 32)

Picture rolls down vertically.

- ☛ Check if the signal cable (DVI Cable) is properly connected to the computer. (See page 30)

A shadowed area appears on the screen.

- ☛ Make sure the resolution and frequency of the computer video card are set properly to the range of the TV. Set the picture again referring to the standard display mode and current mode. (See page 32)

The image is too large or too small.

- ☛ Adjust the picture to use the screen position feature. (See page 23)

Horizontal or vertical bars appear on the screen.

- ☛ Adjust the frequency and fine tuning.
- ☛ Adjust the resolution and frequency to the recommended specifications. (See page 32)
(1366 x 768 @ 60Hz)

The power indicator light blinks green.

- ☛ The TV is in power saving mode. The picture will return to normal status when you press any key on the keyboard or move the mouse.

Specifications

Model name		LCD 26	
LCD	Size	26" Diagonal	
	Display Size	580.8 mm (H) x 328.8 mm (V)	
	Pixel Pitch	0.1405 mm (H) x 0.4215 mm (V)	
	Pixel Number	1366 x 768 (WXGA)	
	Type	a-Si TFT active matrix	
	Brightness	500 cd / m ²	
	Contrast Ratio	600 : 1	
	Viewing Angle	176°(H) / 176°(V)	
TV/VIDEO	Colour System	PAL / SECAM / AV NTSC	
	Sound System	D/K, I, L, L'.M	
	Video System	CVBS, S-VHS	
COMPONENT	Y / Pb / Pr	COMPONENT1,2 : 480i/p, 576i/p, 720p, 1080i	
SCART	Video Input	1.0 Vp-p @ 75 ohm	
	Audio Input	500mV RMS	
	RGB Input	0.7 Vp-p @ 75 ohm	
PC	Sync.	Horizontal	30 ~ 61KHz
		Vertical	56 ~ 75Hz
	Display Colour	16.7M (true)	
	Max. Resolution	1360 x 768	
	Sync.(H/V Separate)	Positive or Negative	
Audio Output		5W + 5W (2Way 4Speaker, 4Ω)	
Power Supply		Internal Type AC 110 ~ 240V, 50 / 60Hz	
Power Consumption		MAX. 97W	
Stand-by Mode		< 3W	
Dimension (W x H x D)		686.0mm x 546.2mm x 105mm (Stand 215mm)	
Weights		22.5Kg	
Accessories		Remote Control, Battery (AAA type), Operating Instructions Power Cord	

☛ Design and specifications are subject to change without notice.

Model name		LCD 32	
LCD	Size	32" Diagonal	
	Display Size	697.64 mm (H) x 392.25 mm (V)	
	Pixel Pitch	0.170 mm (H) x 0.510 mm (V)	
	Pixel Number	1366 x 768 (WXGA)	
	Type	a-Si TFT active matrix	
	Brightness	500 cd / m ²	
	Contrast Ratio	600 : 1	
	Viewing Angle	176°(H) / 176°(V)	
TV/VIDEO	Colour System	PAL / SECAM / AV NTSC	
	Sound System	D/K, I, L, L'.M	
	Video System	CVBS, S-VHS	
COMPONENT	Y / Pb / Pr	COMPONENT1,2 : 480i/p, 576i/p, 720p, 1080i	
SCART	Video Input	1.0 Vp-p @ 75 ohm	
	Audio Input	500mV RMS	
	RGB Input	0.7 Vp-p @ 75 ohm	
PC	Sync.	Horizontal	30 ~ 61KHz
		Vertical	56 ~ 75Hz
	Display Colour	16.7M (true)	
	Max. Resolution	1360 x 768	
	Sync.(H/V Separate)	Positive or Negative	
Audio Output		7.5W + 7.5W (2Way 4Speaker, 4Ω)	
Power Supply		Internal Type AC 110 ~ 240V, 50 / 60Hz	
Power Consumption		MAX. 127W	
Stand-by Mode		< 3W	
Dimension (W x H x D)		810.7mm x 634.8mm x 105mm (Stand 245mm)	
Weights		25Kg	
Accessories		Remote Control, Battery (AAA type), Operating Instructions Power Cord	

☛ Design and specifications are subject to change without notice.



P/N :

Free Manuals Download Website

<http://myh66.com>

<http://usermanuals.us>

<http://www.somanuals.com>

<http://www.4manuals.cc>

<http://www.manual-lib.com>

<http://www.404manual.com>

<http://www.luxmanual.com>

<http://aubethermostatmanual.com>

Golf course search by state

<http://golfingnear.com>

Email search by domain

<http://emailbydomain.com>

Auto manuals search

<http://auto.somanuals.com>

TV manuals search

<http://tv.somanuals.com>