

CBX100 Installation Manual

The CBX100 is a connection box which can be used as an accessory to facilitate system connections for installation and device replacement of several Datalogic family reading devices.

System cabling is made through spring clamp terminal blocks inside the CBX100 while the reading device is connected to the CBX100 through a 25-pin connector on the housing.

A 9-pin connector placed inside the CBX100 facilitates connection between an external PC and the auxiliary serial interface of the reading device for configuration or data monitoring.

CBX100 can also house an accessory Backup and Restore Module to make system maintenance extremely quick and easy.

GENERAL VIEW



Figure A

- ① Indicator LEDs
- ② Cover Screws (2)
- ③ Compression Connectors (4)
- ④ 25-pin Device Connector

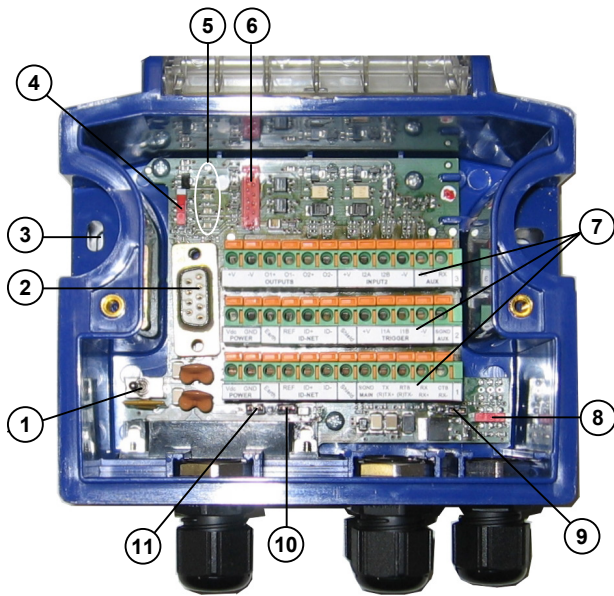

Figure B

- ① Power switch (ON/OFF)
- ② Auxiliary Port Connector
- ③ Mounting Holes (2)
- ④ ID-NET™ Termination Resistance Switch
- ⑤ Indicator LEDs
- ⑥ Backup Module Connector
- ⑦ Spring Clamp Terminal Blocks
- ⑧ RS485 Termination Resistance Switch
- ⑨ Power Source Selector
- ⑩ Shield to Protection Earth Selector
- ⑪ Chassis Grounding Selector

SAFETY PRECAUTIONS

ATTENTION: READ THIS INFORMATION BEFORE INSTALLING THE PRODUCT

POWER SUPPLY

This product is intended to be installed by Qualified Personnel only. This device is intended to be supplied by a UL Listed NEC Class 2 power source.

CAUTION

Total power consumption is given by adding the CBX100 power consumption to that of all the devices powered through the CBX100 (reading device, P.S., I/O). Refer to the manual of the connected devices for details about minimum/maximum supply voltage and power consumption.

Each CBX100 supports only 1 single reading device + system accessories.

SUPPORTED READING DEVICE MODELS

The CBX100 can be directly connected to the following readers through the 25-pin connector illustrated in Figure A.

Linear Scanners				2D Readers	
DS2100N	DS2400N	DS4800	DS6300	MATRIX-1000	MATRIX-2000
DS6400	DX6400	DS8100A	DX8200A		MATRIX 400

NOTE

CBX100 is backward compatible with DS4600A, DS2100N/DS2400N (black body), and DS1100/DS2200 10-30 Vdc model reading devices using the ADP-MM1 25-pin gender changer. See the Gender Changer documentation for the relative CBX100 pinout.

OPENING THE CBX100

To install the CBX100 or during normal maintenance, it is necessary to open it by unscrewing the two cover screws:

CAUTION

The CBX100 must be disconnected from the power supply during this operation.

MECHANICAL INSTALLATION

CBX100 can be mounted to various wooden or plastic surfaces using the two self-threading screws (3.9 x 45 mm) and washers provided in the package.

Mounting to other surfaces such as concrete walls or metallic panels requires user-supplied parts (screws, screw anchors, nuts, etc). A mounting template is included in the package to facilitate hole drilling alignment.

CBX100 can also be mounted to a DIN rail or a Bosch Frame using the following mounting accessories: BA100 (93ACC1821), BA200 (93ACC1822).

The diagram below gives the overall dimensions of the CBX100 and shows the two mounting through-holes.

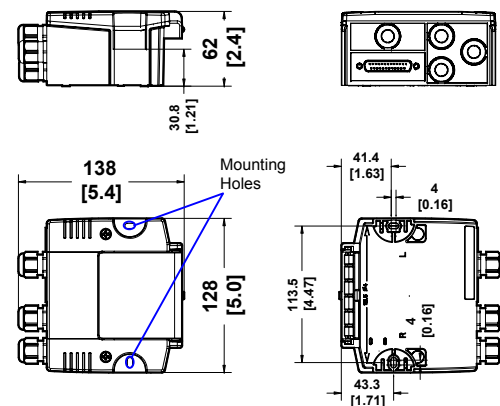

Figure 1 - Overall Dimensions

ELECTRICAL CONNECTIONS AND SETUP

The following figure shows a typical layout.

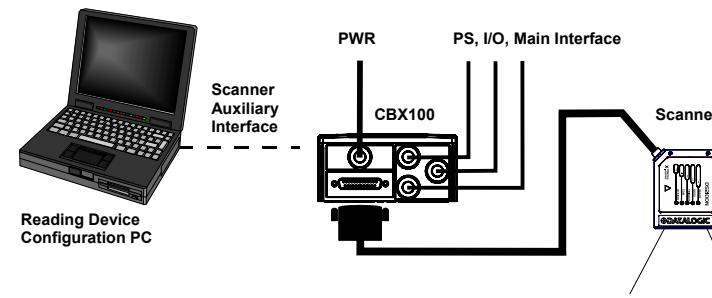

Figure 2 – System Layout

The dotted line in the figure refers to an optional (temporary) hardware configuration in which a portable PC can be quickly connected to the CBX100 (and consequently to the reading device auxiliary interface) through the internal 9-pin connector. This allows monitoring of the data transmitted by the reading device or configuration through the utility program (see the reading device Installation Manual for more details). The reading device auxiliary interface signals are also available on the internal spring clamp connectors.

After making system cabling and switch settings, connect the reading device to the 25-pin connector on the CBX100 housing.

Switch ON the CBX100 power switch (see Figure 3). The Power LED turns on (blue) when the power connection has the correct polarity. The Power LED turns on (red) in case of wrong polarity.

After system functioning has been verified, close the CBX100 using the 2 cover screws.

POWER SUPPLY

Power is supplied to the CBX100 through the Vdc and GND pins provided on the spring clamp connector.

The power switch (see Figure 3) switches the power supply ON or OFF for both the CBX100 and the connected reading device.

CAUTION

The power switch does not control power to the Vdc/GND, +V/-V spring clamps, therefore any devices connected to these signals (i.e. external trigger, encoder, etc.), are live and are not protected from polarity inversion. Disconnect the power supply when working inside the CBX100.

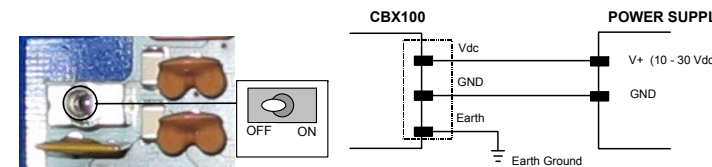

Figure 3 - Power Switch ON/OFF Positions and Connections

NOTE

Vdc is electrically connected to +V, just as GND is electrically connected to -V. This is useful for supplying external trigger, inputs and outputs from the CBX100 power source, however +V and -V signals should not be used as power supply inputs to the CBX100.

The power supply must be between 10 and 30 Vdc only.

NOTE

To avoid electromagnetic interference:

- Connect CBX100 Protection Earth (Earth) to a good earth ground.
- Connect the reading device chassis to earth ground through the jumper, (default setting, see Figure 7).
- Connect the Network Cable Shield (Shield) to Filtered Earth through the jumper (default setting, see Figure 6).

SYSTEM WIRING

The connection and wiring procedure for CBX100 is described as follows:

- 1) Open the CBX100 by unscrewing the 2 cover screws.
- 2) Verify that the CBX100 power switch is off (see Figure 3).
- 3) Unscrew the compression connectors and pass all the system cables through them into the CBX100 housing.
- 4) To connect the power and input/output signals:
 - Prepare the individual wires of the system cables by stripping the insulation back approximately 1 cm.
 - Using a device such as a screwdriver, push down on the lever directly next to the clamp (see Figure 4).
 - Insert the wire into the clamp and release the lever.

The wire will now be held in the spring clamp.
- 5) Tighten the compression connector nuts so that the internal glands seal around the cables.

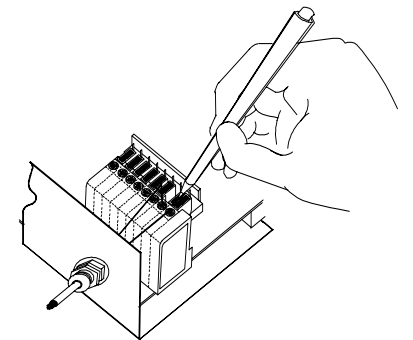

Figure 4 - System Cable Connections

Flexible stranded wire should be used and must meet the following specifications.

All positions: 24 - 16 AWG 0.2 - 1.5 mm²

The CBX100 spring clamp connector pinouts are indicated in the Pinout table.

Refer to the reading device Installation Manual for signal details.

Pinouts				
Group	Name	Function		
Input Power	Vdc	Power Supply Input Voltage +		
	GND	Power Supply Input Voltage -		
	Earth	Protection Earth Ground		
External Trigger Input	+V	Power Source – External Trigger		
	I1A	External Trigger A (polarity insensitive)		
	I1B	External Trigger B (polarity insensitive)		
	-V	Power Reference – External Trigger		
Generic Input	+V	Power Source – Inputs		
	I2A	Input 2 A (polarity insensitive)		
	I2B	Input 2 B (polarity insensitive)		
	-V	Power Reference – Inputs		
Outputs	+V	Power Source – Outputs		
	-V	Power Reference – Outputs		
	O1+	Output 1 +		
	O1-	Output 1 -		
	O2+	Output 2 +		
	O2-	Output 2 -		
Auxiliary Interface	TX	Auxiliary Interface TX		
	RX	Auxiliary Interface RX		
	SGND	Auxiliary Interface Reference		
ID-NET™	REF	Network Reference		
	ID+	ID-NET™ Network +		
	ID-	ID-NET™ Network -		
Network	Shield	Network Cable Shield		
Main Interface		RS232	RS485FD	RS485HD
		TX	TX+	RTX+
		RTS	TX-	RTX-
		RX	*RX+	
		CTS	*RX-	
		SGND	SGND	SGND

The input power signals Vdc, GND and Earth as well as the network signals REF, ID+, ID- and Shield are repeated to facilitate system cabling. In this way the power and network busses can enter and exit the CBX100 from different spring clamps but be physically connected together.

POWER SOURCE JUMPER SETTINGS

For most applications input power is provided through the dedicated spring clamp connectors inside the CBX100.

However CBX100 may accept power from the connected reading device through the 25-pin connector. This is useful, for example, to pass power to connected accessories such as Encoder and Presence Sensor from DX8200A VAC models or 6K/8K scanners powered directly through the network. See the relative reading device Reference Manual for details.

To power CBX100 from the reading device, the power source jumper must be placed in the "power from device" position as indicated in Figure 5.

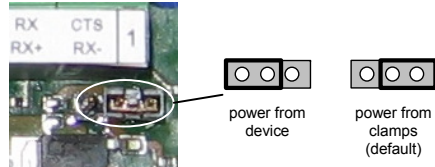

Figure 5–Power Source Jumper Settings

SHIELD TO PROTECTION EARTH JUMPER SETTINGS

The network cable shield (Shield) can be connected to Earth Ground (Earth) either directly or through a filter circuit. If the jumper is left open, the network cable shield (Shield) is floating.

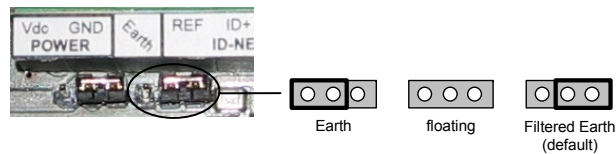

Figure 6– Shield to Protection Earth Jumper Settings

CHASSIS GROUNDING JUMPER SETTINGS

The reading device chassis grounding method can be selected by positioning a jumper (see Figure 7). In this way the reading device chassis can be connected to earth ground (only if pin Earth is connected to a good earth ground). For all reading devices except 6K/8K, the chassis can alternatively be connected to the power supply ground signal (GND) or it can be left floating but, in this case, the jumper must be removed. For 6K or 8K scanners the chassis is internally connected to GND.

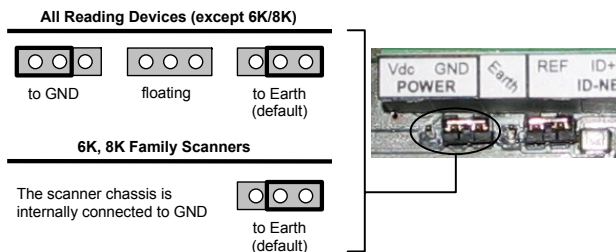

Figure 7 – Chassis Grounding

9-PIN READING DEVICE AUXILIARY SERIAL INTERFACE

The reading device auxiliary serial interface available on the internal CBX100 9-pin connector can be used either for configuration or for data monitoring.

Connections can be made to a PC or Laptop using a straight through cable or a USB-RS232 converter.

The details of the connector pins are indicated in the following table:

CBX100 9-pin D-Sub Female Connector Pinout		
Pin	Name	Function
2	TX	Auxiliary RS232
3	RX	Auxiliary RS232
5	SGND	Auxiliary Reference Ground
1, 4, 6, 7, 8, 9		N.C.

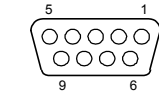

NETWORK BUS TERMINATION

ID-NET™

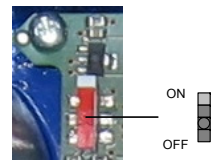
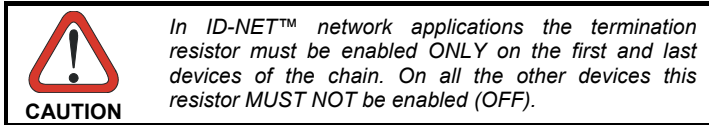

Figure 8 – ID-NET™ Termination Resistance Switch

The ID-NET™ termination resistance switch enables or disables the insertion of the bus termination resistor for ID-NET™ network applications.



RS485 HD

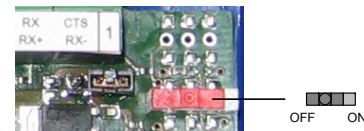
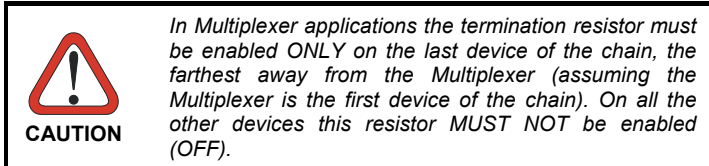

Figure 9 – RS485 HD Termination Resistance Switch

The RS485 HD termination resistance switch enables or disables the insertion of the bus termination resistor for RS485 Half Duplex Multidrop applications.



BM100 BACKUP AND RESTORE MODULE (ACCESSORY)

The BM100 Backup and Restore Module (separate accessory) provides configuration parameter backup. It can easily be installed by aligning it over its corresponding connector in the CBX100 and pushing down until correctly seated. When closed, the plastic support inside the CBX100 cover holds the module in place. For further details see the BM100 manual.

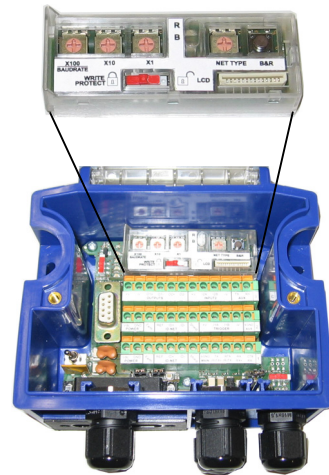

Figure 10 – BM100 Accessory Mounting

INDICATOR LEDS

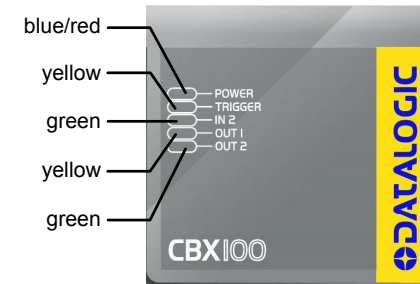
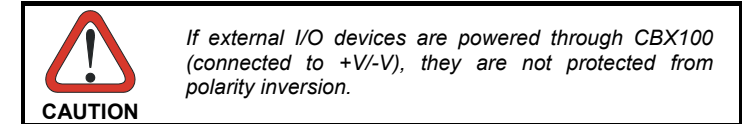

Figure 11 – Indicator LEDs

There are five Indicator LEDs which signal power and I/O activity and are visible from the CBX100 outside cover.

The Power LED is blue when power is correctly applied to the CBX100 and the power switch is turned on.

This LED is red if power polarity is incorrect. In this case the connected reading device and optional Backup Module are protected.



The remaining four LEDs signal activity on the relative I/O lines. Their meaning depends on the software configuration of the connected reading device.

TECHNICAL FEATURES

ELECTRICAL FEATURES	
Supply Voltage	10 to 30 Vdc*
Consumption	0.5 – 0.3 A
Limited Current Consumption	2.5 A Max
CBX + reading device consumption (see related manual)	
USER INTERFACE	
LED Indicators	Power On/Polarity Error (blue/red) Trigger (yellow) IN2 (green) OUT1 (yellow) OUT2 (green)
PHYSICAL FEATURES	
Mechanical Dimensions	138 x 128 x 62 mm (5.4 x 5 x 2.4 in.)
Weight	about 380 g. (13.40 oz.)
ENVIRONMENTAL FEATURES	
Operating Temperature	0° to 50 °C (+32° to 122 °F)
Storage Temperature	-20° to 70 °C (-4° to 158 °F)
Humidity max.	90% non condensing
Vibration Resistance	14 mm @ 2 to 10 Hz
EN 60068-2-6	1.5 mm @ 13 to 55 Hz
2 hours on each axis	2 g @ 70 to 200 Hz
Shock Resistance	30 g; 11 ms;
EN 60068-2-27	3 shocks on each axis
Protection Class	IP65
EN 60529	(when compression connectors and reading device are correctly connected)

The features given are typical at a 25 °C ambient temperature (if not otherwise indicated).

* for further details about minimum/maximum supply voltage refer to the manual of the connected reading device, since the minimum supply voltage required may be >10.

SERVICES AND SUPPORT

Datalogic provides several services as well as technical support through its website. Log on to www.automation.datalogic.com and click on the [links](#) indicated for further information including:

- **PRODUCTS**
Search through the links to arrive at your product page where you can download specific **Manuals** and **Software & Utilities**:
- **SERVICES & SUPPORT**
 - **Datalogic Services** - Warranty Extensions and Maintenance Agreements
 - **Authorised Repair Centres**
- **CONTACT US**
E-mail form and listing of Datalogic Subsidiaries

CE COMPLIANCE

Warning: This is a Class A product. In a domestic environment this product may cause radio interference in which case the user may be required to take adequate measures.

DATALOGIC... DECLARATION OF CONFORMITY

Datalogic Automation S.r.l.
Via S. Vitalino 13
40012 - Lippo di Calderara
Bologna - Italy

dichiara che
declares that the
déclare que le
bescheinigt, daß das Gerät
declare que el

CBX100, connection box compact

e tutti i suoi modelli
and all its models
et tous ses modèles
und seine Modelle
y todos sus modelos

sono conformi alle Direttive del Consiglio Europeo sottoelencate:
are in conformity with the requirements of the European Council Directives listed below:
sont conformes aux spécifications des Directives de l'Union Européenne ci-dessous:
der nachstehend angeführten Direktiven des Europäischen Rats:
cumple con los requisitos de las Directivas del Consejo Europeo, según la lista siguiente:

89/336/EEC EMC Directive e 92/31/EEC, 93/68/EEC emendamenti successivi
and further amendments
et ses successifs amendements
und späteren Abänderungen
y sucesivas enmiendas

Basate sulle legislazioni degli Stati membri in relazione alla compatibilità elettromagnetica ed alla sicurezza dei prodotti.
On the approximation of the laws of Member States relating to electromagnetic compatibility and product safety.
Basée sur la législation des Etats membres relative à la compatibilité électromagnétique et à la sécurité des produits.
Über die Annäherung der Gesetze der Mitgliedsstaaten in bezug auf elektromagnetische Verträglichkeit und Produktsicherheit entsprechen.
Basado en la aproximación de las leyes de los Países Miembros respecto a la compatibilidad electromagnética y las Medidas de seguridad relativas al producto.

Questa dichiarazione è basata sulla conformità dei prodotti alle norme seguenti:
This declaration is based upon compliance of the products to the following standards:
Cette déclaration repose sur la conformité des produits aux normes suivantes:
Diese Erklärung basiert darauf, daß das Produkt den folgenden Normen entspricht:
Esta declaración se basa en el cumplimiento de los productos con las siguientes normas:

EN 55022 (Class A ITE), September 1998: INFORMATION TECHNOLOGY EQUIPMENT
RADIO DISTURBANCE CHARACTERISTICS
LIMITS AND METHODS OF MEASUREMENTS

EN 61000-6-2, September 2005: ELECTROMAGNETIC COMPATIBILITY (EMC)
PART 6-2: GENERIC STANDARDS – IMMUNITY FOR
INDUSTRIAL ENVIRONMENTS

Lippo di Calderara, January 29th, 2008

Lorenzo Girotti
Product & Process Quality Manager

Free Manuals Download Website

<http://myh66.com>

<http://usermanuals.us>

<http://www.somanuals.com>

<http://www.4manuals.cc>

<http://www.manual-lib.com>

<http://www.404manual.com>

<http://www.luxmanual.com>

<http://aubethermostatmanual.com>

Golf course search by state

<http://golfingnear.com>

Email search by domain

<http://emailbydomain.com>

Auto manuals search

<http://auto.somanuals.com>

TV manuals search

<http://tv.somanuals.com>