

datavideo®

CD DVD VIDEO DISK RECORDER

VDR-3000



INSTRUCTION MANUAL

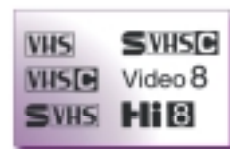

<http://www.datavideo-tek.com>



CONTENTS

Introduction

Packing list -----	3
Front & Rear Panel -----	4
Display Panel -----	7
Remote Control Handset -----	8

Connections

Connection a TV/Monitor -----	11
Connecting an analog video source -----	12
Connecting a DV video source (DV Model only) -----	13
Connecting a digital still camera -----	14
Connecting to a Project TV /monitor with component video-----	15
Connecting a digital audio CD player -----	16

Operation

Switching on -----	17
Playing a disk -----	17
Recording a disk -----	18

PC Playback

Playing CD's in your PC -----	20
Grabbing Frames from your CD to save or e-mail -----	22

Advanced Operation

Color correcting the video source before recording -----	23
--	----

Frequently Asked Questions -----	24
---	----

Specifications -----	32
-----------------------------	----

Contact Information -----	33
----------------------------------	----

PACKING LIST

VDR-3000 is supplied with the following accessories:

Infrared Remote Control Handset

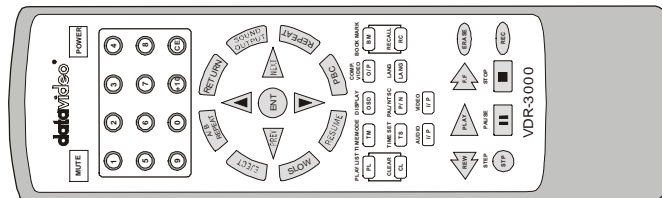

2 x "AAA" Batteries for Handset

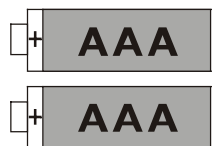

Main Power Cord



S-Video Cable



3 Phono (RCA) to 3 Phono (RCA) Audio/Video Cable



IEEE1394 "Firewire" Cable (DV Model only)



CD-RW Rewritable CD.

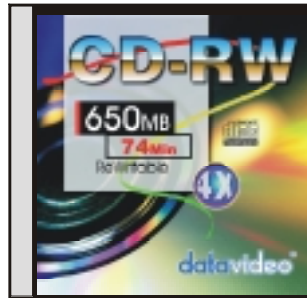

Rear Panel

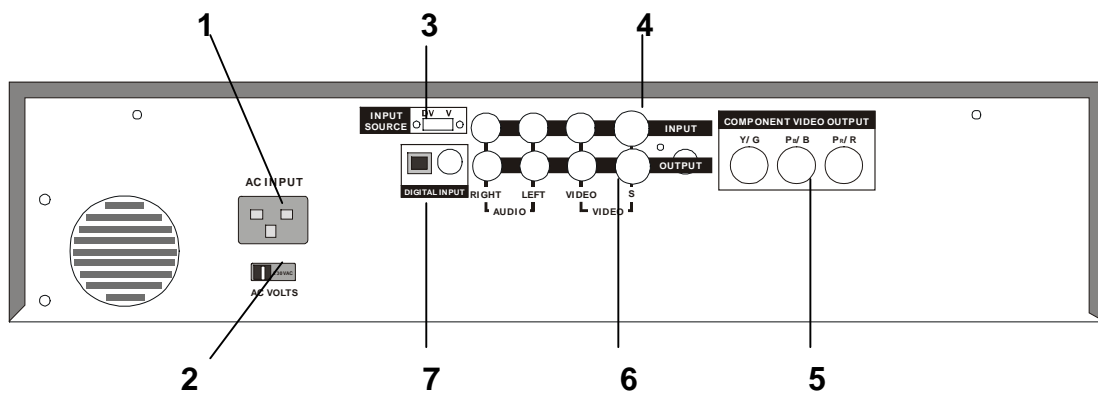

1. Main Power Cord connecting socket

To connect to the main power supply

2. AC Main voltage selector

Sets the voltage input to 115 VAC or 230VAC. *Note: This setting does not need to be changed under normal conditions. Do not adjust this setting without consulting your dealer or a qualified electrician.*

3. Input Source Selector Switch (DV Model only)

To select DV or Analog Video Input

4. Audio and Video Inputs

To connect left and right audio and composite or S-Video signals from a camcorder/VCR etc.

5. Component Video Output

Component Y.U.V. or R.G.B. video signal output for project or big screen TV/Monitor. *Note: The component video output cannot be used with the S(Y/C) output and the composite output at the same time. Outputting to both outputs will lower the video output level.*

6. Audio and Video Outputs

To connect to a TV or Monitor

7. Digital Audio Input

To connect a audio digital signal from a CD player to duplicate an audio CD without sound quality loss. Please note: The Audio Digital Duplicate is only available with Audio CD-R due to copyright protection.

Front Panel

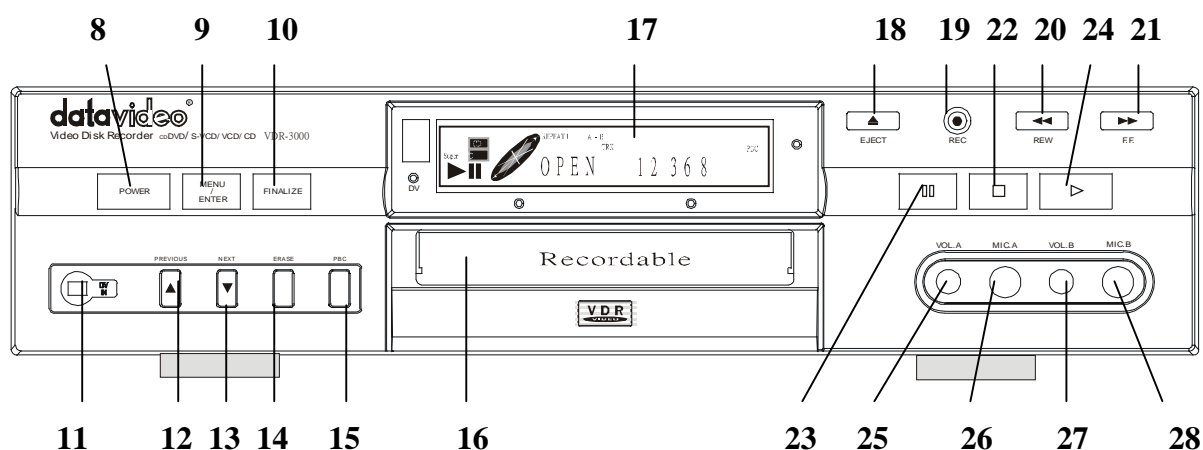

8. Power Button

To switch the unit from On to Standby mode or vice versa.

9. Menu/Enter Button

This button contains two functions: **Menu** and **Enter**

Menu: Press this key to open the Color Processor on screen menu for adjustment

Enter: To select a recording format **cdDVD**, **DVD-PHOTO**, **S-VCD**, **HQ-VCD**, **VCD** or Audio CD after inserted the blank disc into CD tray

10. Finalize Button

To finalize the disc. Until a disc is finalized it can only be played back in the VDR 3000. A finalized disc can be played back in other suitable devices such as Audio CD, VCD, S-VCD, DVD player or CD-ROM in PC.

11. IEEE 1394 DV "iLink" Socket (DV Model only)

To input Digital Video/Audio from DV Camcorders etc.

12. Previous Button

To skip back to the previous track during playback or to navigate up the on screen menu options

13. Next Button

To skip forward to the next track during playback or to navigate down the on screen menu options

14. Erase Button

To erase the data on a CD-RW disc. Erasing takes a CD-RW disc takes around 2 minutes irrespective of how much data is on the disc. *Note: The Erase feature does not function with CD-R discs.*

15. PBC Button

Playback control button for commercially produced VCD's

16. CD Tray

To load discs into the unit

17. Display Panel (see separate illustration)

Shows current status of unit.

18. Eject Button

To Open the CD Tray for loading or removing CD

19. REC Button

To start recording

20. REW Button

To picture search backward through a track. Several speeds are available each press of the button will increase the speed.

21. F.F. Button

To picture search forward through a track. Several speeds are available each press of the button will increase the speed.

22. STOP Button

To stop the disk during playback or record

23. PAUSE Button

To pause the disk during playback

24. PLAY Button

To start the disk playing

25. Microphone Volume Control (Left/Mono)

To control the volume of the Left Channel Microphone. Also controls the volume of mono microphone track.

26. Microphone Input Jack (Left/Mono)

Input Jack for Left Channel Microphone. Also for single mono microphone.

27. Microphone Volume Control (Right)

To control the volume of the Right Channel Microphone.

28. Microphone Input Jack (Right)

Input Jack for Right Channel Microphone.

Display Panel

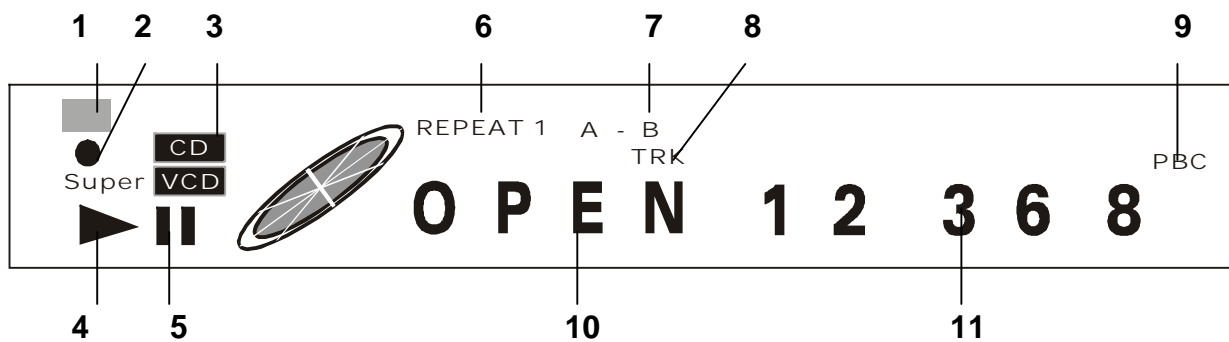

1. **Infrared receiver**
Receives signals from the Infrared Remote Control Handset
2. **DV on LED**
Indicates the DV source is selected
3. **CD/Super/VCD**
Indicates the format of the loaded disk or the selected recording format
4. **Play Indicator**
Indicates that the disk is playing
5. **Pause Indicator**
Indicates that the disk is paused
6. **Repeat**
Indicates that Repeat function is activated
7. **A-B Repeat**
Indicates that A-B Repeat function is activated
8. **Track Indicator**
Indicates the total number of tracks on the disk when the disk is static or the track number when the disk is playing
9. **PBC**
Indicates that Play Back Control function is activated
10. **Initial Status Display**
 - - - - Indicates no disk
OPEN Indicates the CD Tray is open
LOAD Indicates the inserted disk is loading
11. **Counter Display**
Indicates in Hours: Minutes: Seconds the total duration of the disk when the disc is static or the position within a track when the disk is playing.

Infrared Remote Control Handset

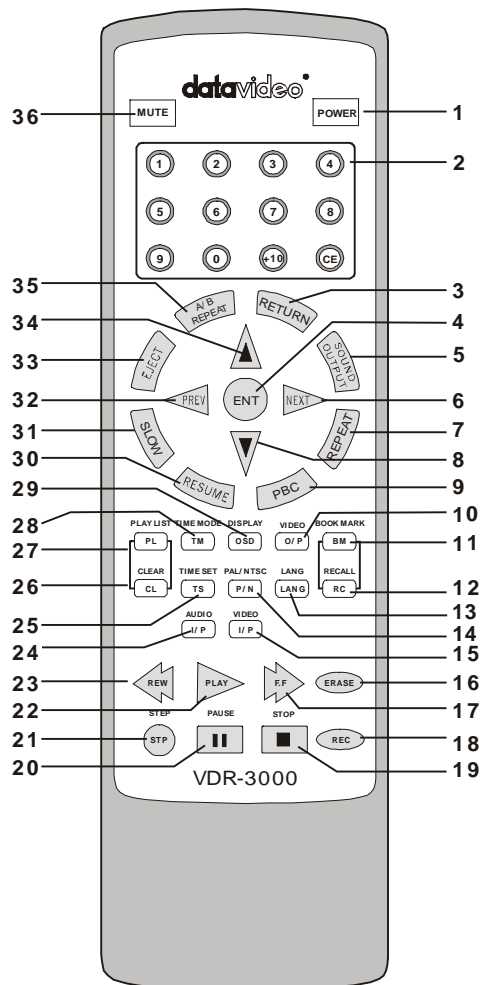

1. Power Button

To switch the unit from On to Standby mode or vice versa.

2. Numerical Keypad

To give direct access to tracks on a disk

3. RETURN Button

To return to the first track on a disk

4. ENT Button (ENTER)

This button contains two functions: **Menu** and **Enter Menu**: Press this key to open the Color Processor on screen menu.

Enter: To select a recording format DVD-PHOTO, S-VCD, VCD or Audio CD after inserted the blank disc into CD tray

5. Sound Output

To select the sound output mode: Left, Right or Stereo channel output

6. NEXT Button

To skip forward to the next track during playback or to navigate down the on Screen

- 7. REPEAT Button**
Offers repeat playback options. Press once to repeat a single track, twice to repeat the entire disk or three times to turn repeat function off.
- 8. DOWN Arrow**
Navigates down through on screen menu options. Also with on screen controls reduces the setting
- 9. PBC Button (Playback Control)**
Offers playback control options for commercially produced VCD's
- 10. Video Output Button**
To select video output format: Composite, S (Y/C), Y.U.V. or RGB video
- 11. BM Button (Book Mark)**
To mark a reference point on a track for later recall
- 12. RC Button (Recall)**
Goes to the book mark reference point
- 13. LANG Button**
To set the on screen menu language English or Chinese
- 14. P/N Button (PAL/NTSC)**
To select video input format PAL, NTSC or AUTO detect system
- 15. Video I/P Button (CV/S)**
To select analog video input source. Select CV to input via Phono (RCA) or S to input via the mini 4 Pin S-Video sockets.
- 16. Erase Button**
To erase the data on a CD-RW. Erasing takes a CD-RW takes around 2 minutes in respect of how much data is on the disk
Note: The Erase feature does not function with CD-R discs.
- 17. F.F. Button**
To picture search forward through a track. Several speeds are available each press of the button will increase the speed
- 18. REC Button**
To start recording
- 19. STOP Button**
To stop the disk during playback or record
- 20. PAUSE Button**
To pause the disk during playback
- 21. STP Button (Step)**
To step forward one frame at a time. (Single Frame Advance)

- 22. PLAY Button**
To start the disk playing
- 23. REW Button**
To picture search backwards through a track. Several speeds are available each press of the button will increase the speed
- 24. Audio Input Button**
To select the digital audio or analog audio input source
- 25. TS Button (Time Set)**
To jump to any point on a disk enter the time in minutes and seconds
- 26. CL Button (Clear)**
Clears entries from the user programmable Play List
- 27. PL Button (Play List)**
Calls up a user programmable Play List of up to 12 tracks
- 28. TM Button (Time Mode)**
To change the counter display from position in the track to time remaining
- 29. OSD Button**
Turns on "On Screen Display". During playback Track number, Counter, Disk format and Audio format can be displayed on the screen
- 30. RESUME Button**
Will resume playback from the same point in a track if playback has been stopped
- 31. SLOW Button**
To select slow motion playback. Three speeds are available press once for $\frac{1}{2}$ speed, twice for $\frac{1}{4}$ speed and three times for $\frac{1}{8}$ speed
- 32. PREV Button (Previous)**
To skip back to the previous track during playback or to navigate up the on screen menu options
- 33. EJECT Button**
To open and close the CD tray
- 34. UP Arrow**
Navigates up through on screen menu options. Also with on screen controls increases the setting
- 35. A/B Repeat Button**
To mark start and stop points within a track for repeat play
- 36. Mute button**
To mute the volume during playback

CONNECTIONS

Connecting to a TV Monitor

NOTE: While connecting please ensure that the VDR 3000 and all devices that you are connecting to are switched off.

The VDR 3000 should be connected to the video and audio inputs of a TV Monitor. The TV Monitor may have a SCART socket, PHONO (RCA) sockets or S-Video socket.

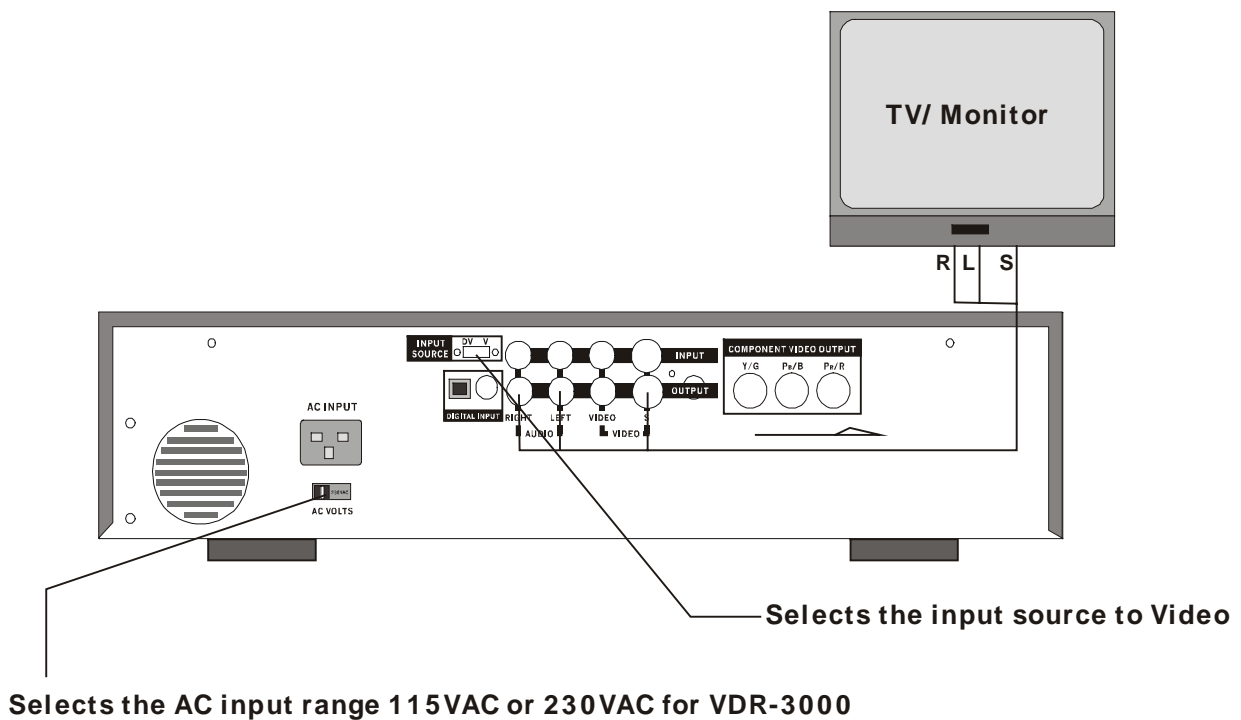

To connect to a SCART input a three phono (RCA) plug (Left and Right Audio plus Composite Video) to SCART Plug cable will be required.

If the TV has an S-Video socket use an S-Video cable for connection as this will give the best quality signal. No connection is required from the Video Out phono (RCA) if S-Video is connected.

Connecting an analog video source

NOTE: While connecting please ensure that the VDR 3000 and all devices that you are connecting to are switched off.

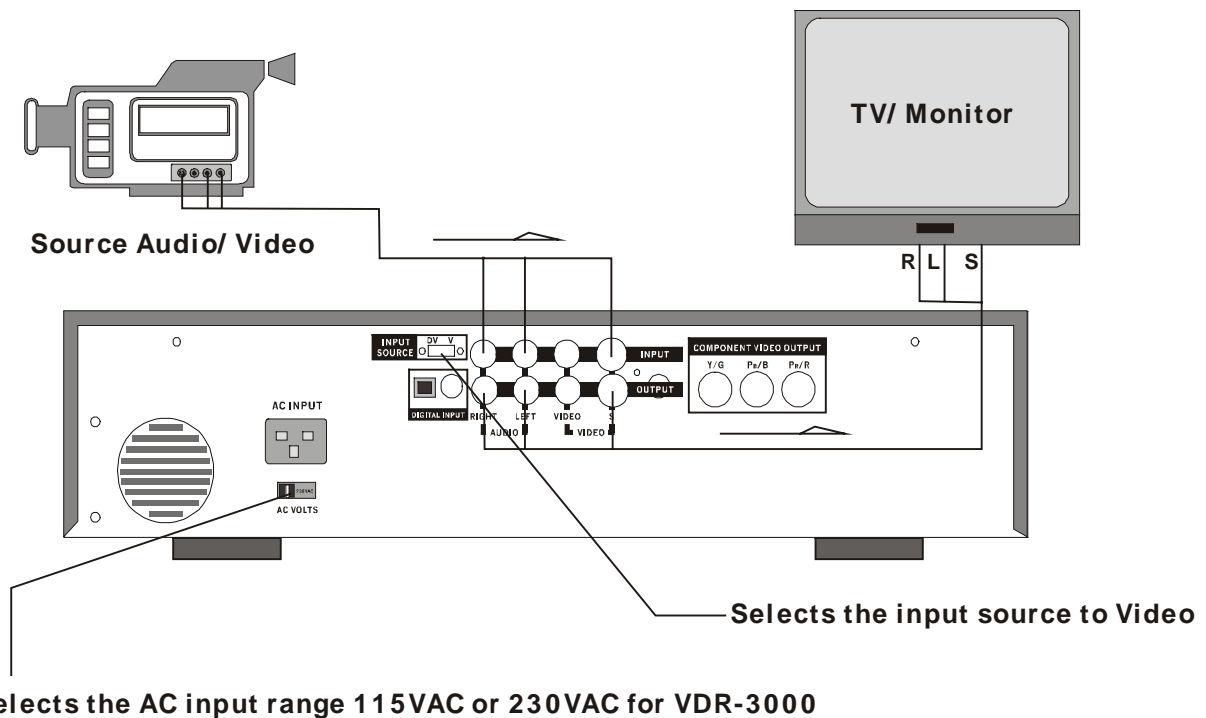

An analog video device can be connected via composite or S-Video if available. Connect the left and right audio output from the device to the left and right audio input on the rear of the VDR 3000. Connect either the composite video out (yellow phono (RCA)) or the S-Video out (mini 4 pin) from the device to the video input on the rear of the VDR 3000. Only connect composite or S-Video – do not connect both. Set the Input Source Selector Switch to the V position.

Connecting a DV video source (DV Model only)

NOTE: During connection please ensure that the VDR 3000 and all devices that you are connecting are switched off.

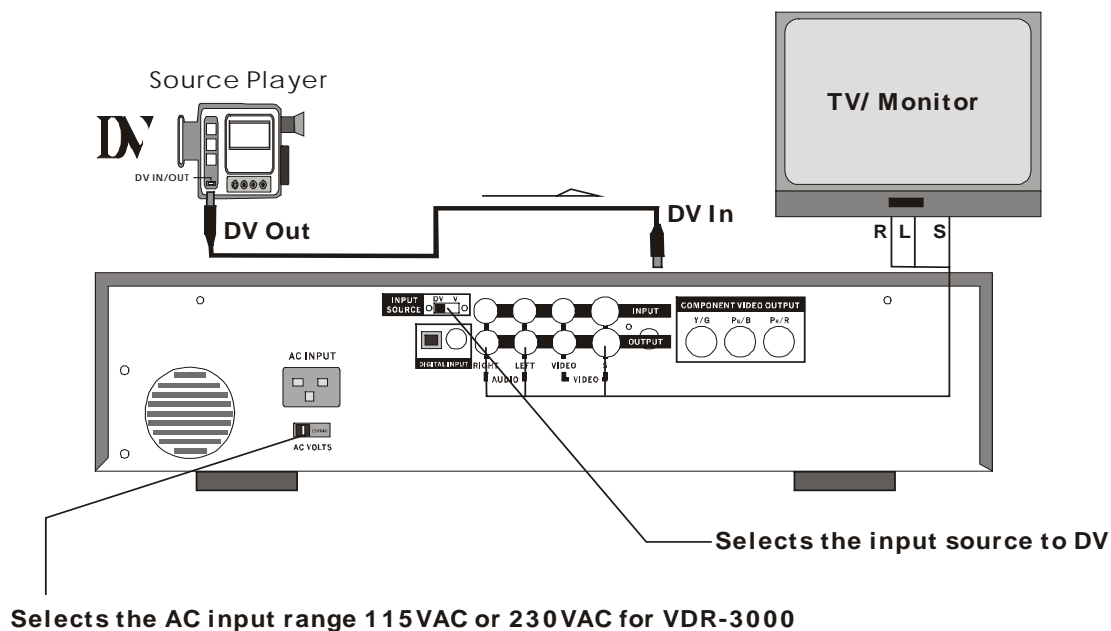

Connect the IEEE1394 "iLink" cable from your DV/mini DV device to the DV Input socket on the front of the VDR 3000.

Set the Input Selector Switch on the rear of the VDR 3000 to the DV position

Connecting a Digital Still Camera

NOTE: While connecting please ensure that the VDR 3000 and all devices that you are connecting to are switched off.

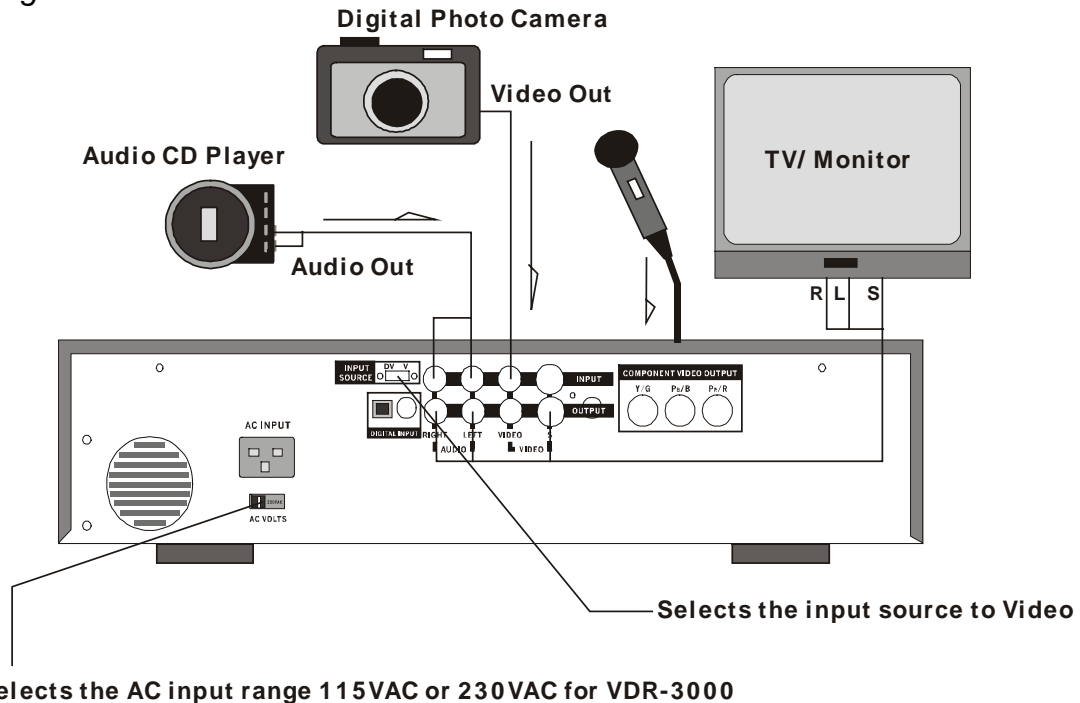

Digital still cameras can be connected to the Video Input on the rear of the VDR 3000. Connect the Video Out from the Digital Still Camera to the Video In Phono (RCA) socket on the VDR 3000. Set the Input Source Selector Switch to the V position.

Note: 1. To achieve a high quality video photo CD, please select the "DVD-PHOTO" video format after you have loaded a blank disc into the VDR 3000.

Do not record more than 98 tracks and 37 minutes on a disk in the DVD-PHOTO format.

Connecting to a Projection TV / Monitor with Component Video

NOTE: While connecting please ensure that the VDR 3000 and all devices that you are connecting to are switched off.

The VDR 3000 should be connected to the component R.G.B. or Y.U.V. video and audio inputs of a Projection TV / Monitor.

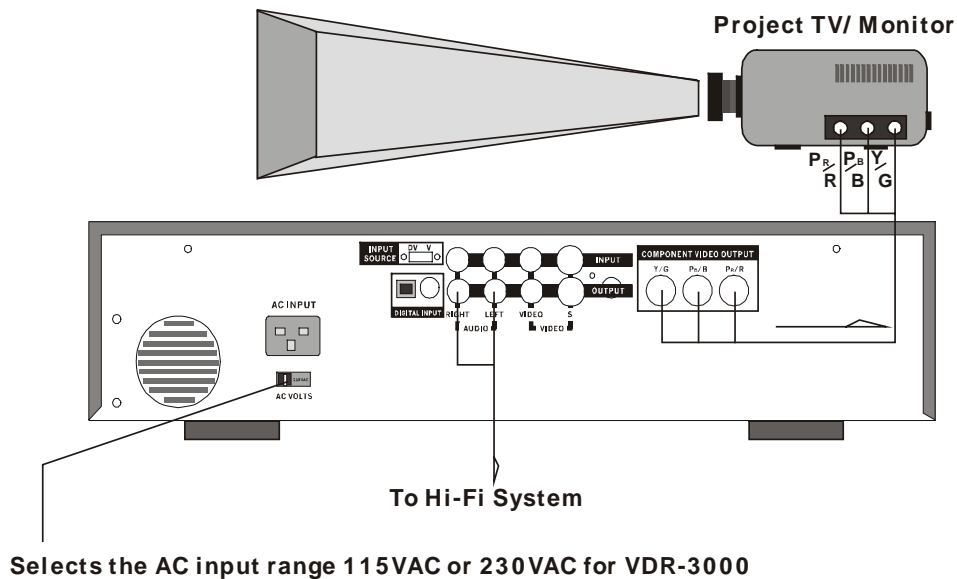

To connect to a component input a three BNC plug (R.G.B. or Y.U.V. Video) to BNC Plug cable will be required.

NOTE: The Composite and S (Y/C) video cables should be disconnected when hooking up the Component video output to TV/Monitor to ensure the best component video level.

Connecting a Digital Audio CD Player (Optional)

NOTE: During connection please ensure that the VDR 3000 and all devices that you are connecting are switched off.

Digital Audio Player

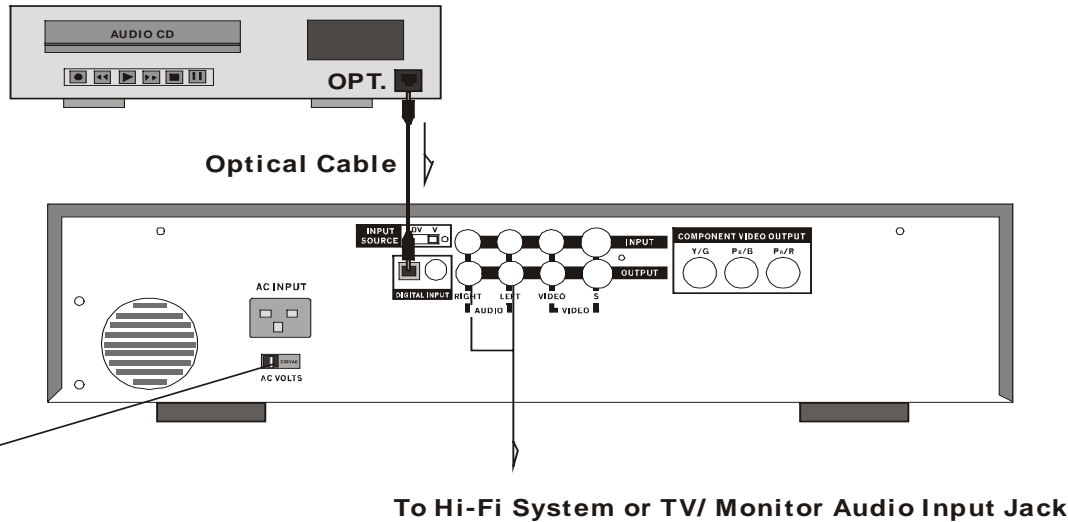

Selects the AC input range 115VAC or 230VAC for VDR-3000

To connect to a digital audio input either a optical fiber plug to a optical fiber plug cable or phono (RCA) plug to phono (RCA) plug cable will be required.

To connect the audio output from VDR 3000 to audio input of either audio hi-fi system or TV/Monitor.

Note: The VDR 3000 requires an Audio CD-R to duplicate Audio CDs because of Copyright protection.

OPERATION

Switching on

Once all cables are in place it is ok to power on the VDR-3000.

Press the Power Button on the front of the VDR 3000 or on the remote control handset, the display panel should light up and display "----".

Power on the TV Monitor and select the correct A/V channel, the VDR 3000 start-up screen will appear. The TV screen it will display "Insert CD".



Playing a disk

Press the Eject Button on the front of the VDR 3000 or on the remote control handset and the CD tray will slide open.

The VDR 3000 will accept Audio CD, VCD, HQ-VCD, S-VCD, DVD-Photo or **cdDVD** disks.

Place the disk that you want to load onto the tray, printed side facing up.

Press the Eject Button and the CD tray will close and "LOAD" will appear on the display panel.

After a few moments the display panel will indicate the format of the loaded disk (CD/VCD/HQVCD/SVCD/DVD-PHOTO/ **cdDVD**). It will also show how many tracks the loaded disk features and the total running time of the disc.

Note: The VDR-3000 cannot play DVD media.

To play the disc from the beginning, press the Play Button on the VDR 3000 or on the remote control handset.

To play a specific track, select the track number from the numeric keypad on the remote control handset.

To skip forward to the next track press the Next Button on the VDR 3000 or remote control handset

¹ Screen shots are simulated.

To return to the previous track press the Previous Button on the VDR 3000 or remote control handset

If you wish to search through a track during playback you can press the F.F. Button. There are several speeds available and pressing the F.F. Button will cycle through to a faster fast forward speed.

To search back through a track, press the REW Button. There are several speeds available and each press of the REW Button will cycle through to a faster rewind speed.

To pause a track during playback, press the Pause Button. This will stop the playback and a still image of the frame will be held on the TV Monitor (video disk only). You can move forward one frame at a time by pressing the STP (STEP) Button. To release the pause and return to normal playback press the Play Button.

To stop playback press the Stop Button.

To silence the track during playback press the Mute Button. To cancel the mute function press the Mute Button a second time.

To remove the disk press the Eject Button, the CD tray will slide open. Remove the disk and press the Eject Button again to close the CD tray.

Recording a disk

The VDR 3000 can record onto CD-R and CD-RW disks. CD-R disks can only be recorded once whereas CD-RW disks can be erased and re-recorded several times.

Press the Eject Button on the front of the VDR 3000 or on the remote control handset and the CD tray will slide open.

Place the disk that you want to record on to in the tray, printed side facing up.

Press the Eject Button and the CD tray will close and "LOAD" will appear on the display panel.

If the disk is blank after a few seconds' six recording format options will appear on the TV screen VCD/HQVCD/SVCD/DVD-PHOTO/ CDDVD and CD-DA. Highlight the format that you want to record in by using the Up/Down Arrow Buttons and then press the Enter Button. This can be achieved by using the front panel of the VDR 3000 or by using the supplied remote control.



The VDR 3000 will take a few moments to prepare the disk for recording. If **cdDVD**, DVD-PHOTO, HQ-VCD, VCD or SVCD has been selected then once prepared the VDR 3000 start up screen will disappear and the system will be ready to start recording. If CD-DA is selected the VDR 3000 start up screen will remain on the TV.

Select the video input source:

DV Input (Option): To select a DV input source, set the slide switch on the rear panel to DV position. **Analog Input:** To select the analog video input, set the slide switch on the rear panel to VIDEO position. To select an analog video format by pressing the “VIDEO INPUT” key on the remote controller. The “Video” will appear on the screen. Press the “VIDEO INPUT” key again to cycle through Video and S-Video source and press the “ENTER” key to select the desire video source.

Note: The default setting is composite video input mode.

Select the audio input source:

Press the “AUDIO INPUT” key on the remote controller to select the digital audio or analog audio input source. *Note: The default setting is set at analog audio input mode.*

Select the video output format:

Press the “VIDEO OUTPUT” key, the video output format would be cycle shown on the top of TV screen:

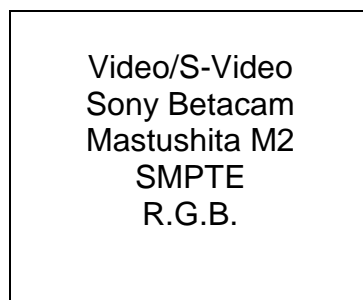

The Sony Betacam, Mastushita M2 and SMPTE format are all output with component Y.U.V. video format with slight different level. Press the “VIDO OUTPUT” key till find the format you want. The default setting is set at Video/S-Video format. *Note: Please don't hook up the video cables to Y.U.V./R.G.B. and Video/S-Video connectors at same time. It will cause the incorrect (lower) video output level.*

NOTE: The VDR-3000 will return to default settings when powered on.

² Screen Shots are simulated.

After set up the audio/video input and output. Start the source machine playing, in the case of a video source the picture will appear on the TV screen. Find the footage that you want to record to the disc and press the Rec. Button.

On the TV screen “record” will appear in the corner of the screen and after a moment “recording” will appear. The display panel will start counting up in minutes and seconds to indicate the recording length. When you reach the end of the footage press the Stop Button.

To start recording the next track press the Record Button again. The Record message will again appear on the TV screen, a new track number will appear on the display panel and the counter will start counting from zero to indicate the record duration of the new track.

When you reach the end of the footage press the Stop Button. The display panel will indicate how many tracks have been recorded and the total record duration of all the tracks on the disc.

The tracks that have been recorded can be played back in the VDR 3000 but until the disc is finalized the disc will not playback in other devices. **Once a disc has been finalized it is not possible to add any further tracks.**

To finalize the disk press the Finalize Button on the front of the VDR 3000.

Note: The disk will be finalized automatically if the whole disk has been filled with audio/video.

Finalizing CD appears on the TV screen. Finalizing takes about two minutes and once finished the message disappears. The finished disk will now playback in other compatible devices.

To remove the disk press the Eject Button, the CD tray will slide open. Remove the disk and press the Eject Button again to close the CD tray.

PC Playback

Datavideo has provided a player that will be recorded onto every CD that is created by the VDR 3000. The player will auto-run in a Windows based Personal Computer.³

³ Personal Computer must meet the minimum required specifications. Datavideo does not guarantee compatibility with all PCs. MMX-enhanced CPU (Intel® Pentium MMX, Pentium II, Celeron, Pentium III, AMD® K6-2, K6-3, Athlon, etc.), Windows® 95/98/NT/2000 with DirectShow® installed (for Windows® NT 4.0 and Windows® 95 download DXMedia® Runtime [here](#)). 32 MB RAM, Any VGA card

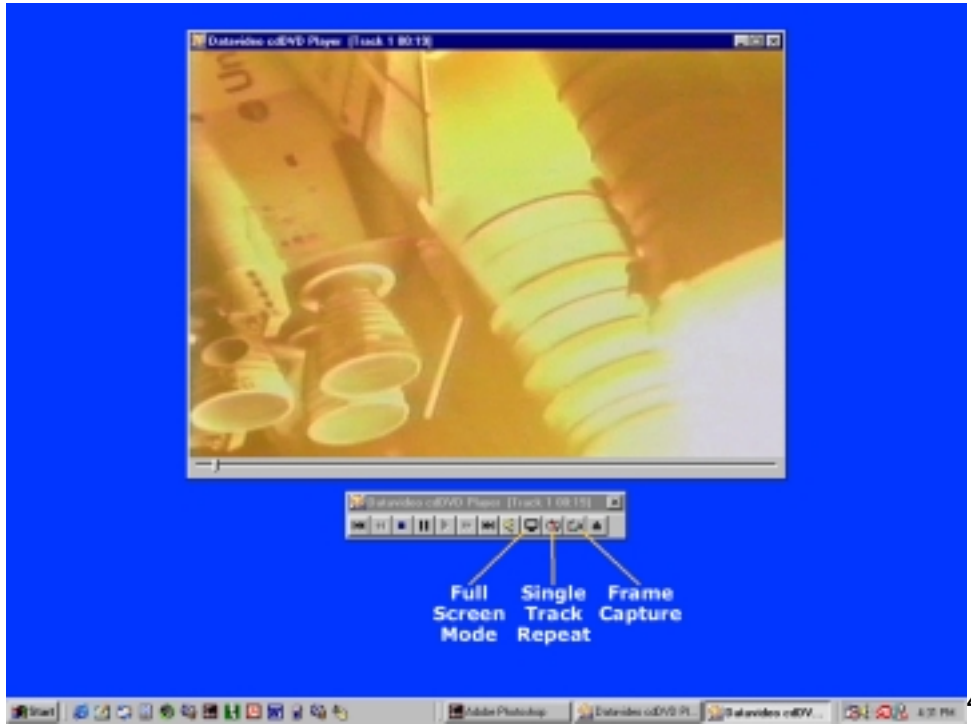

Playing CD's in your PC:

1. The PC auto player is a MPEG-2 decoder, which requires a large amount of PC resources. It is recommended that you close all running applications before inserting the autoplay disk.
2. Insert your disk into your CD-ROM drive.
3. It could take up to 30 seconds for the disk to auto-play. Your PC will start the player if it does not. Double left click "my computer". Double left click your CD-ROM drive



and then double left click "playwnd.exe" icon (`Playwnd.exe`). This should start the auto player.

4. A large video window will appear and a smaller play control window will appear.

Shown below:

Video Window



⁴ Screen shots are simulated.

⁵ Screen shots are simulated.

Player Control

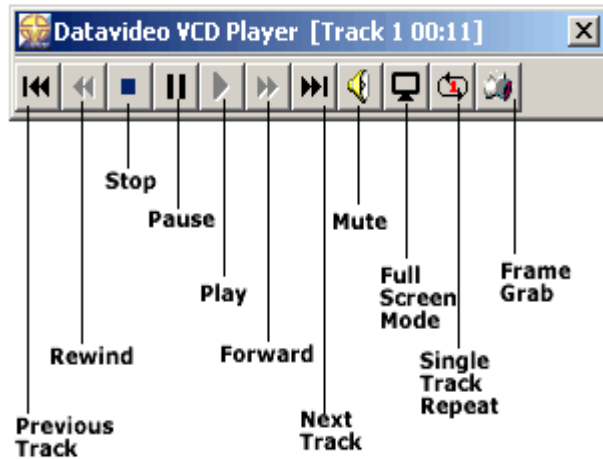

Grabbing Frames from your CD to save or e-mail

1. Make sure the auto player is running.
2. On the player control window there is a Frame Grab Icon (picture of a camera).
3. Once you have decided on a specific frame press the Frame Grab icon immediately.
4. A Save As window will appear, prompting for a file name.
5. Type in your file name and click ok.

Shown Below:

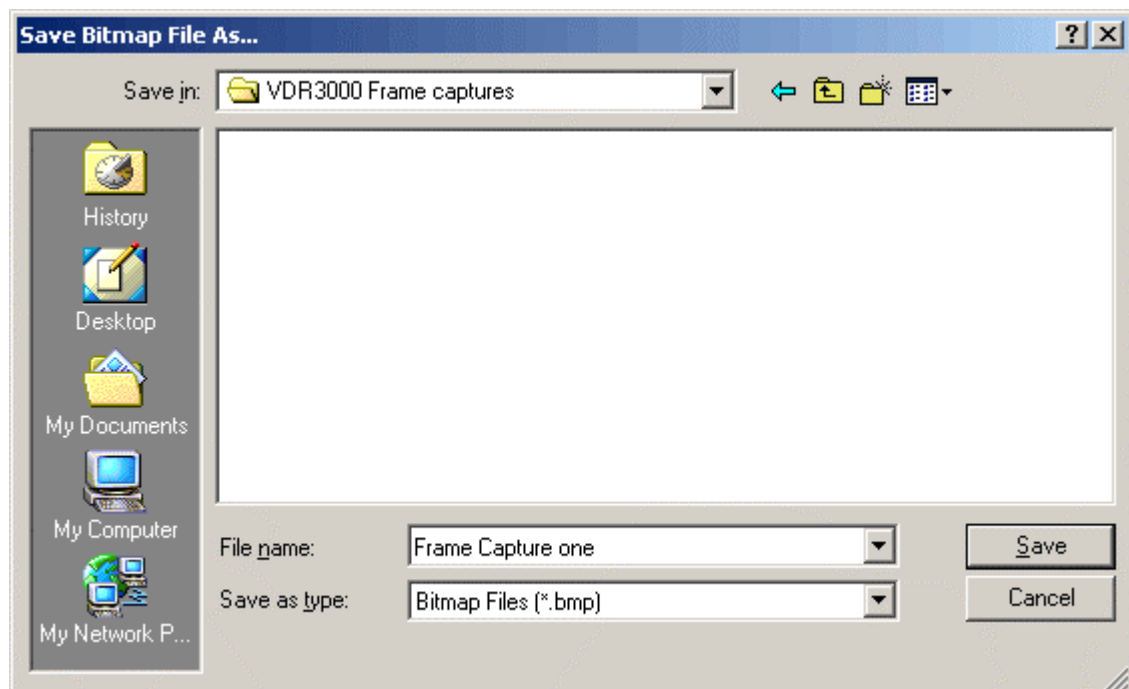

ADVANCED OPERATION

Colour correcting the video source before recording

The VDR-3000 has a built in a Digital Colour Processor that is very useful for recording a videodisc from a low quality video source such as old VHS and Video 8 tape.

To make a correction to the video source, select the video format for the disc and then press the Enter key. The Colour Processor on screen menu will appear on the TV screen,



move the cursor up and down by using the “Up” and “Down” keys to select an adjustment item and then press the “Enter” key again. The high light bar will be shown on the top of TV screen. Please press the “Previous”(-) and “Next”(+) keys to adjust the level of Brightness, Contrast, Sharpness, Colour and Hue (Hue adjustment only available with NTSC system) for the source video. *Note: To ensure to record a active video onto VCD or S-VCD with less blocking. Please adjust the sharpness to “Soft” (high light bar to the end of left side) position.*

Please keep AGC (Auto Gain Control) turned “ON” for recording to ensure that the correct video level is recorded on disc. If the video signal is too bright (can’t see the grade level of light gray color) and cannot be corrected by adjusting the Contrast and Brightness controls. Please switch the AGC to “OFF” by pressing the “Enter” when the cursor is on “AGC On” position. Press the “Enter” key again to switch AGC mode back to “ON” status.

FAQ for the Datavideo Recorders

Q1. Which CD-R and CD-R/W Disc are recommended for use with the VDR-3000?

CD-R Disc		CD-R/W Disc	
Brand	Speed	Brand	Speed
CMC	1-12X	Acer	1-4X
Datavideo	1-12X	CMC	1-4X
FUJI	1-12X	Datavideo	1-4X
LeadData	1-12X	Megadata	1-4X
Mitsubishi	1-12X	Mitsubishi	1-4X
Maxell	1-12X	Princo	1-4X
Mitsui	1-12X	Ritek	1-4X
Prodisc Silver	1-12X	RICOH	1-4X
PIONEER	1-12X	Seantram	1-4X
Ritek	1-12X		
RICOH	1-12X		
SONY	1-12X		
TDK	1-12X		
Taiyo Yuden	1-12X		
	1-12X		

Note: These discs have been tested, there are many others that will work that have not been tested.

Q 2. Why will a CD-R Disc written by the VDR-3000 not play back in some home VCD or DVD Players?

Some VCD or DVD Players do not support CD-R disc playback, so it cannot recognize the CD-R that's written by the VDR-3000. See the attached VCD/DVD player list for your reference.

Q3. What is the difference of VCD, HQ-VCD, S-VCD, DVD-Photo and *cdDVD* format ?

VCD: MPEG-1 is a compression format compatible with most of VCD and DVD players. The VCD disc can be played back by most VCD players, DVD players and Microsoft Media Player Software on a PC. Since the VCD has a low resolution and low bit rate 1.15Mbps format that is a good application for long recording times without degrading too much of the image quality. This is ideal for seminars and conference audio/video recording. VCD can record 74 minutes audio/video program on a 650MB CD-R disc.

HQ-VCD: MPEG-1 compression format is compatible with most media players. The HQ-VCD can be played back by most DVD or S-VCD players and Microsoft Media Player software on a PC. HQ-VCD has a low resolution but high bit rate 4Mbps, which is good for recording the active video without blocking effect. The HQ-VCD can record 37 minutes of audio/video on a 650MB CD-R.

S-VCD: MPEG-2 compression format. The S-VCD player or DVD player that supports S-VCD format can playback the S-VCD disc. PC CD-ROM can also playback the S-VCD with the Datavideo auto PC player. The S-VCD has double the resolution compared with VCD and also has a higher bit rate 2.4Mbps. The S-VCD can record 37 minutes of audio/video on a 650MB CD-R.

DVD-Photo: MPEG-2 video compression format. The DVD-Photo disk can be played back on a DVD player which supports S-VCD format and can be played back by PC CD-ROM with the Datavideo auto PC player. DVD-Photo is full D1 resolution (same as DVD) but only available for still images or slow motion video sources due to low data transfer rate of 2.4Mbps for a high video resolution. The DVD-Photo mode is very useful for creating a video album with high quality images on disk. The DVD-Photo can record upto 98 images on a CD-R disc with DVD video image quality.

cdDVD: MPEG-2 compression format. The **cdDVD** disk can be played back by newer version DVD players and by a PC's CD-ROM drive with our auto player. The **cdDVD** disk is full D1 resolution (same as DVD) with a very high data transfer rate of 4.8Mbps. It provides high quality video images for presentations, educational or personal video collections. The **cdDVD** disk can record 18 minutes audio/video program on a 650MB CD-R.

Q4. Why will home DVD Players not playback SVCD Discs.

- 1、SVCD is not a DVD standard format, so most DVD Players do not support SVCD Disc playback.
- 2、Some VCD or DVD Players do not support CD-R disc playback, so it cannot recognize the CD-R written by the VDR-3000. See the attached VCD/DVD player list for your reference.

Q5. Why will the recorded video not synchronize with it's audio on playing back?

We have evaluated similar conditions on playing back the disc with few Players, but this problem won't happen on playing back the disc by most famous brand of VCD/DVD player, such as Pioneer, SAMPO, ACER... so it is a VCD/DVD player related compatible problem.

Q6. Why does the VDR-3000 take a much longer time on reading some various Brands of CD-R, CD-R/W discs?

Some CD-R, CD-R/W disc are not fully compatible with the VDR 3000 CD-R/W drive, so it will take a longer time to recognize the new disc or sometimes it will fail. We recommend using the Datavideo specific VDR-1000R CD-R or VDR-1000R/W CD-R/W disc, which have been verified and approved good quality for VDR-3000.

Q7. Why does the recorded video have some flicking or shifting phenomenon?

Most of the root cause is the original video source quality, problems due to too old VHS tape or others. Datavideo manufactures a Time Base Corrector machine TBC-1000 or TBC-3000, which you may use it to correct the unstable video source and color processing (TBC-3000 only).

Q8. Why does recording fail on some discs.

If there are more than 10% recording fail situation, please contact Datavideo for further support.

According to the quality level of CD-R disc manufacture:

The "A" grade disc field failure rate is about --- 2%

The "B" grade disc field failure rate is about --- 6%

The "C" grade disc field failure rate is about --- 10%

So there is the opportunity to have a failure recording due to bad disk.

Q9. Why do some recorded CD-R/W discs have mosaic video or overlay video effect after a few erase and re-write cycles?

It's because the erase operation was not completed; you may double erase the disc in VDR-3000 to resolve the problem.

Q10. What is the right setting for Power MAC G4 or iMAC to output video to VDR-1000/3000DV for producing Video CD disc?

- a). Require MAC O.S. 9.0.4 and QuickTime V4.1.2 for Power MAC G4 or iMAC
- b). Please use the Final Cut Pro or iMovie software utility in the G4 for video capture
- b). To disable the "remote function" in the Apple fire wire device control and treat the VDR-1000DV interface as a video capture card, which means you need to "click" on capture video manually as soon as the video is showing on the screen.
- c). Online Un-plug the VDR-1000/3000DV fire wire cable from the G4 and re-plug it back again to initialize the cable link and the G4 will find the correct protocol to work with VDR-1000/3000DV.

Q11. Why am I getting the error message "Vencmpeg did not start"?

The VDR-3000 needs to have a signal to synchronize to before it records. This error message is usually given when a user enables recording on the VDR-3000 before playing back source material. When recording from DV(IEEE/1394) you must play your source before pressing record on the VDR-3000. Running 10 seconds of black should allow for a smooth recording entry.

Q12. Why isn't the DV input working?

When connecting to your unit make sure that you have switched the selector switch in the back of the VDR-3000 to "DV". Once the DV selector switch is changed to DV, a red led will appear on the front panel of the VDR-3000. Play your source video and watch to see that the video is appearing on your monitor.

Q13. Why doesn't the S-video input work?

If you want to record from an S-video input source the selector button on the remote control must be pressed when the unit is powered up. On the lower right corner of the remote control there is a button marked "I/P" this is the button that must be pressed. The default input for video is composite (RCA type connectors) if you don't change the input the S-video input will roll and the video signal will not pass through.

Q14. Why doesn't the CD-R disc that was written by the VDR-3000 play back in my home DVD player?

Not all consumer dvd players are compatible with the VCD or SVCD formats. Some consumer dvd players are unable to read CD-R and CD-RW discs.

Q15. Is there a way to get Windows Media Player or any other editing program to recognize the "avseq01.dat" file created by the VDR-3000?

The file name and extension of the raw mpeg file can be renamed to a "*.mpg" extension. Windows Media Player is able to recognize this format.

Note: This will only work with mpeg-1 formats (VCD and HQ-VCD Modes) that are created on the VDR-3000.

To achieve this, follow the directions below:

Explore your VCD or HQ-VCD disk in Windows Explorer
Look for a folder called "MPEGAV" (this is where each track of *.dat files are saved in) Copy the AVSEQ01.DAT file to C:\ or any directory on your hard drive. Right click your "AVSEQ01.DAT" file and choose "Rename"
Rename the file (anyname).MPG
Then press - Enter

The file now appears as a Windows Media Player icon with the name you gave it.

The file will now be recognized as such and will open in programs that are compatible with Windows Media Player.

Q16. What do I do if my machine has a rolling picture and I am inputting an NTSC signal?

The unit could be set to the wrong format such as PAL @25 frames/second. To change the input selector back to NTSC mode, the remote control is needed.

There is a button on the remote called "P/N" it stands for PAL/NTSC. It sets the input format of the machine. To change it back to NTSC please do the following:

1. Power the VDR on.
2. Insert a blank CD-R.
3. Select any recording format. (VCD, etc.)
4. Press the "P/N" button on the remote controller.
5. Keep pressing it until it either says "Auto or NTSC".
(Either one of these modes should be fine.)
6. Once this is completed, eject the blank disk and discard it.
This should make the PAL menu display go away and put the VDR 3000 into NTSC mode.

Q17. DVD Players that can play back CD-R, CD-RW Discs and CD-DVD SVCD HQ-VCD and VCD format video (For reference only)

DVD Model	Capable of CD-R Playback	Capable of CD-R/W Playback	DVD players that can playback <i>CD-DVD, HQ-VCD, SVCD, VCD</i> <i>Unless otherwise noted, VCD playback only is assumed</i>
Acer DVD-5150	Yes	Yes	<i>CD-DVD, SVCD, HQ-VCD, VCD</i>
Afreey LD-2060	Yes	Yes	SVCD, <i>HQ-VCD</i> , VCD MP3
Aiwa XD-DV500	Yes	?	
Apex AD-500 /600/660/700/703	Yes	Yes	SVCD, HQ-VCD, VCD, MP3
Amoisonic DVR2000	Yes	Yes	SVCD, HQ-VCD, VCD, MP3
Amoisonic DVD8506	Yes	Yes	SVCD, VCD, MP3
Denon DVD1500	Yes	?	
Denon DV3000	No	Yes	
Denver JVD200	Yes	Yes	MP3
Digitron DVS360	Yes	No	SVCD, HQ-VCD, VCD, MP3
DMW360 Sanyo	Yes	Yes	
Eclipse	Yes	Yes	SVCD, HQ-VCD, VCD, MP3
Formax AV-2188	Yes	Yes	<i>CD-DVD, SVCD, HQ-VCD, VCD</i>
GE Digital GE1105P	Yes	Yes	
GPX DV2000	Yes	Yes	SVCD, HQ-VCD, VCD, MP3
Hitachi DV-K2	No	No	
Hitachi DV-P250/E/U	Yes	Yes	
Hitachi DV-P300U	Yes	Yes	SVCD, HQ-VCD, VCD, MP3
Hitachi DV-P505U	Yes	Yes	SVCD, HQ-VCD, VCD, MP3
HTK DVD868T	Yes	Yes	<i>CD-DVD, SVCD, HQ-VCD, VCD</i>
Hoyo 8200	Yes	Yes	
JVC XV-D501BK	Yes	Yes	
JVC XV-D701	No	Yes	
JVC XV-511	Yes	Yes	
JVC XV-515GD	Yes	No	
JVC XV-523GD	Yes	Yes	
JVC XV-521/525BK	Yes	Yes	
Kenwood DVF 5010/7010	No	Yes	
Kiss 1302/1502	Yes	Yes	SVCD, HQ-VCD, VCD, MP3
Kones DVD-3000	No	Yes	MP3
Konka KD-1800U	Yes	Yes	
Labway Xwave 900	Yes	Yes	SVCD, HQ-VCD, VCD
Lasonic 850/2000	Yes	Yes	SVCD, HQ-VCD, VCD, MP3
LB 900 Xwave	Yes	Yes	SVCD, HQ-VCD, VCD, MP3
Lennox 725B	Yes	Yes	SVCD, HQ-VCD, VCD
Loewe Xemix	Yes	Yes	
Marantz DVD-890	Yes	No	
Marantz DVD-4000	Yes	?	
Memorex MVD-2025/2026	Yes	?	
Metz DE81	Yes	Yes	

DVD Model	Capable of CD-R Playback	Capable of CD-R/W Playback	DVD players that can playback <i>CD-DVD, HQ-VCD,SVCD,VCD</i> <i>Unless otherwise noted, VCD playback only is assumed</i>
MICO A980	Yes	Yes	SVCD、HQ-VCD、VCD、MP3
Microboss MP3 Rock	Yes	Yes	
Micromega minium	Yes	Yes	
Oritron DVD200	Yes	Yes	
Panasonic A100	No	Yes	
Panasonic A105	No	Yes	
Panasonic A110	No	Yes	SVCD, HQ-VCD ,VCD
Panasonic A115	No	Yes	Drop frames
Panasonic A120	No	Yes	
Panasonic A160	No	Yes	
Panasonic A300/ 310/320/350/360	No	Yes	
Panasonic L50	Yes	Yes	
Panasonic LV75	Yes	No	
Panasonic M360K	Yes	Yes	CD-DVD , SVCD, HQ-VCD ,VCD
Panasonic P10	Yes	No	
Panasonic RV20	Yes	No	
Panasonic RV30	Yes	Yes	
Panasonic SCHAT80	No	Yes	
Panasonic T-2000	No	Yes	
Phoenix 203	Yes	Yes	
Philips DVD701	Yes	Yes	
Philips DVD701/710/ 711/718/730/750/751/ 825/865AT/ 930/940/950/955	Yes	Yes	SVCD, HQ-VCD ,VCD
Philips DVD315AT	?	Yes	
Phoenix 204	Yes	?	
Pioneer DV-333/414/ 434/505/515/525(K)/5 35/606(D)/626(D)/717 /C302D/C530D/F727	Yes	Yes	
Pioneer DV-K101	No	Yes	
Pioneer DV-K102	Yes	Yes	
Pioneer DV-K505	Yes	Yes	
Pioneer DVL 909/91	Yes	Yes	
Pioneer PDV-LC10	Yes	Yes	
Pioneer NS-DV1	Yes	Yes	
Pioneer NS-DV55	Yes	?	
Pioneer NS- VSX09TX	Yes	?	
ProScan PS8682P	No	No	
Raite AVPhile 713 / 715/722D/727D	Yes	Yes	CD-DVD , SVCD, HQ-VCD ,VCD
RCA 5210P	Yes	Yes	
RCA 5215P/5220P/ 5221P/5223P	No	Yes	

DVD Model	Capable of CD-R Playback	Capable of CD-R/W Playback	DVD players that can playback CD-DVD, HQ-VCD, SVCD, VCD <i>Unless otherwise noted, VCD playback only is assumed</i>
Sampo DVE 560+	Yes	Yes	CdDVD, HQ-VCD, SVCD, VCD
Sampo DVE-611	Yes	Yes	CdDVD, HQ-VCD, SVCD, VCD
Sampo DVE-660	Yes	Yes	CdDVD, HQ-VCD, SVCD, VCD
Samsung DVD608/611/709/711 /811/812/909	Yes	Yes	
Samsung DVD 927	Yes	No	
Sanyo DVD 6070	Yes	?	
Sharp 600U	No	Yes	
Shinco DVD 360	Yes	No	
Shinco DVD 8320	Yes	Yes	
Shinco DVD 868	Yes	Yes	
Skyworth	Yes	Yes	SVCD、HQ-VCD、VCD、MP3
Smart DVD 2000	Yes	Yes	
SMC 330S/530	Yes	Yes	SVCD、HQ-VCD、VCD、MP3
SM Supervision 2000	Yes	?	
Sony DAVS-300	Yes	Yes	
Sony DVP-C600D	Yes	No	
Sony DVP-C650D	No	Yes	
Sony DVP-CX850D	No	Yes	
Sony DVP-FX1	Yes	Yes	
Sony DVP-K330	No	Yes	
Sony DVP-S300	Yes	Yes	Can not use the blue color CD-R
Sony DVP-S315	Yes	No	Can not use the blue color CD-R
Sony DVP-S325	Yes	Yes	
Sony DVP-S330	Yes	Yes	
Sony DVP-S335	Yes	Yes	
Sony DVP-S336	Yes	Yes	
Sony DVP-S360	Yes	Yes	
Sony DVP-S3000	Yes	No	
Sony DVP-S500D	Yes	Yes	
Sony DVP-S501D	Yes	No	
Sony DVP-S525D	Yes	Yes	
Sony DVP-S530D	No	Yes	
Sony DVP-S550D	Yes	Yes	
Sony DVP-S560D	No	Yes	
Sony DVP-S715	Yes	Yes	
Sony DVP-S725D	Yes	Yes	
Sony DVP-S7700	Yes	No	
Thomson DTH 2500	Yes	No	
Thomson DTH 2600	No	Yes	
Tokal 715S	Yes	Yes	SVCD、HQ-VCD、VCD、MP3
Toshiba SD1200	No	Yes	SVCD、HQ-VCD、VCD
Toshiba SD2107	No	No	
Toshiba SD2109	Yes	Yes	

DVD Model	Capable of CD-R Playback	Capable of CD-R/W Playback	DVD players that can playback <i>CD-DVD, HQ-VCD,SVCD,VCD</i> <i>Unless otherwise noted, VCD playback only is assumed</i>
Toshiba SD2200	Yes	Yes	
Toshiba SD3107	Yes	No	
Toshiba SD3107e	Yes	?	
Toshiba SD3109	No	Yes	Drops frames
Whanedale DVD-750	Yes	No	
Yamaha DVDS 795	No	?	

Note:

YES: Only Means that it can read a particular media type.

NO: Only means that it cannot read a particular media type.

? : Means it has not been tested.

It would be appreciated if you can add to the compatibility information of DVD players, which we can share with other users. For new information on DVD players, please mail to service@datavideo.com.tw

SPECIFICATIONS:

- Playback Disc Type CDDVD/DVD-Photo/SVCD/HQ-VCD/VCD/Audio CD
- Recorder Disc Type CD-R, CD-R/W 650MB
- Audio CD sampling rate 44.1KHz, 16bit CD quality
- Video format CCIR601 NTSC and PAL
- CDDVD NTSC 704x480 at 30fps
PAL 704x576 at 25fps
Bit rate at 4.8Mb/sec
- DVD-Photo NTSC 704x480 at 30fps
PAL 704x576 at 25fps
Bit rate at 2.4Mb/sec
- S-VCD video resolution NTSC 352x480 at 30fps
PAL 352x576 at 25fps
Bit rate at 2.4Mb/sec
- HQ-VCD video resolution NTSC 352x240 at 30fps
PAL 352 x288 at 25fps
Bit rate at 2.4Mb/sec
- VCD video resolution NTSC 352x240 at 30fps
PAL 352 x288 at 25fps
Bit rate at 1.15Mb/sec
- Video inputs: Y/C (S-Video) mini DIN
CVBS (Video) RCA
Optional DV (IEEE1394/i-Link) 4-pin connector
*. By DV25 YUV 4:1:1 NTSC or YUV 4:2:0 PAL at 25Mb/sec bit rate
- Video Outputs: Y/C (S-Video) mini DIN
CVBS (Video) RCA
Y.U.V. Sony Betacam BNC
Y.U.V. Mastushita M2 BNC
Y.U.V. SMPTE BNC
R.G.B. BNC
- Digital Audio Input S/PDIF 44.1KHz, 16bit CD quality
- Audio Inputs: Stereo RCA 20Hz – 20KHz
- Audio Outputs: Stereo RCA 20Hz – 20KHz
- Microphone input Two dynamic microphone inputs, 600 ohm
- Power supply 115 –230VAC, 50/60Hz selectable
- Dimension 16.1x11.8x3.6 inches (410x300x92mm)
- Weight 9.3lbs / 4.2kg

Personal Computer Playback Minimum System Requirements:

MMX-enhanced CPU (Intel® Pentium MMX, Pentium II, Celeron, Pentium III, AMD® K6-2, K6-3, Athlon, etc.),

Windows® 95/98/NT/2000 with **DirectShow®** installed (for Windows® NT 4.0 and

Windows® 95 download **DXMedia® Runtime** [here](#)).

32 MB RAM

VGA card

Datavideo does not guarantee compatibility with all PCs.

For further information or technical support, visit our website at: www.datavideo-tek.com.

If your question cannot be answered from the website, please contact one of our locations.

Datavideo Locations

Datavideo Corporation USA
12300-U East Washington Blvd.,
Whittier, CA 90606
Tel: (562) 696-2324
Email: info@datavideo-tek.com

Datavideo Technologies Europe
Bv
Californiedreef 26,
3565 BL Utrecht, The
Netherlands
Tel: +31 30 261 9656
Email: info@datavideo.nl

Datavideo Technologies Co., LTD.
7F. Number 352, secretary. 2, Chung
Shan Rd.
Chung Ho City, Taipei Hsien,
Taiwan R.O.C.
Tel: 886-2-2246-7979
Email: info@datavideo.com.tw

www.datavideo-tek.com

P/N: 0820603112E

Free Manuals Download Website

<http://myh66.com>

<http://usermanuals.us>

<http://www.somanuals.com>

<http://www.4manuals.cc>

<http://www.manual-lib.com>

<http://www.404manual.com>

<http://www.luxmanual.com>

<http://aubethermostatmanual.com>

Golf course search by state

<http://golfingnear.com>

Email search by domain

<http://emailbydomain.com>

Auto manuals search

<http://auto.somanuals.com>

TV manuals search

<http://tv.somanuals.com>