



Vantage Pro2™ Console Manual

For Vantage Pro2™ & Vantage Pro2 Plus™ Weather Stations



Davis Instruments, 3465 Diablo Avenue, Hayward, CA 94545 • 510-732-9229 • www.davisnet.com

Vantage Pro2 Console Display Features

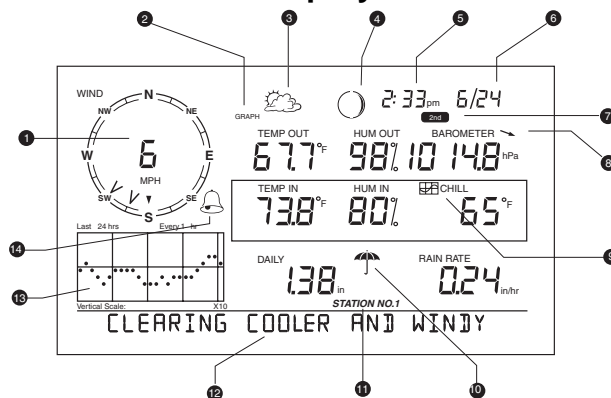

Display Features

- | | |
|---------------------------------|------------------------------|
| 1. Compass Rose | 8. Barometric Trend Arrow |
| 2. Graph & Hi/Low Mode Settings | 9. Graph Icon |
| 3. Forecast Icons | 10. Current Rain Icon |
| 4. Moon Phase Indicator | 11. Station Number Indicator |
| 5. Time/Sunrise Time | 12. Weather Ticker |
| 6. Date/Sunset Date | 13. Graph Field |
| 7. 2ND Button Indicator | 14. Alarm Icon |

FCC Part 15 Class B Registration Warning

This equipment has been tested and found to comply with the limits for a Class B digital device, pursuant to Part 15 of the FCC Rules. These limits are designed to provide reasonable protection against harmful interference in a residential installation. This equipment generates, uses, and can radiate radio frequency energy and, if not installed and used in accordance with the instructions, may cause harmful interference to radio communications.

However, there is no guarantee that interference will not occur in a particular installation. If this equipment does cause harmful interference to radio or television reception, which can be determined by turning the equipment on and off, the user is encouraged to try to correct the interference by one or more of the following measures:

- Reorient or relocate the receiving antenna.
- Increase the separation between the equipment and receiver.
- Connect the equipment into an outlet on a circuit different from that to which the receiver is connected.
- Consult the dealer or an experienced radio/TV technician for help.

Changes or modification not expressly approved in writing by Davis Instruments may void the warranty and void the user's authority to operate this equipment.

IC: 378810-6312

EC EMC Compliance

This product complies with the essential protection requirements of the EC EMC Directive 89/336/EC.

Vantage Pro 2 Console Manual

Rev. C, November 19, 2004

Document Part Number: 07395.234

For Vantage Pro2 Consoles # 6312 & 6312C

And Vantage Pro2 Weather Stations # 6152, 6152C, 6153, 6162, 6163

Vantage Pro[®] and Vantage Pro2[™] are trademarks of Davis Instruments Corp., Hayward, CA.

© Davis Instruments Corp. 2004. All rights reserved.

Information in this document subject to change without notice.

Table of Contents

Welcome to Vantage Pro2™	1
Console Features	1
Vantage Pro Options	2
Installing the Console	4
Powering the Console	4
Installing the AC Power Adapter	4
Installing Batteries	5
Connecting Cabled Stations	5
Console Location	6
Using Your Weather Station.....	9
Setup Mode	9
Current Weather Mode	20
Selecting Units of Measure	21
Displaying the Forecast.....	27
Displaying Time & Date or Sunrise & Sunset.....	27
Calibrating, Setting, and Clearing Variables	27
Highs and Lows Mode	30
Alarm Mode	32
Graph Mode	34
Troubleshooting and Maintenance	37
Vantage Pro2 Troubleshooting Guide	37
Console Diagnostic Screens.....	39
Console Maintenance.....	42
One Year Limited Warranty	42
Weather Data	43
Specifications.....	49
Console	49
Wireless Communication Specifications	49
Console Data Display Specifications.....	50
Weather Data Specifications.....	51
Vantage Pro2 Console Icons.....	53

Chapter 1

Welcome to Vantage Pro2™

Welcome to your Vantage Pro2 Weather Station console. The console displays and records your station's weather data, provides graph and alarm functions, and interfaces to a computer using our optional WeatherLink software.

Vantage Pro2 stations are available in two basic versions: Cabled and Wireless. A Cabled Vantage Pro2 station transmits outside sensor data from the Integrated Sensor Suite (ISS) to the console using a straight-through four-conductor cable. A Wireless Vantage Pro2 station transmits outside sensor data from the ISS to the console via a low-power radio. Wireless stations can also collect data from the optional Vantage Pro2 sensors. See "Optional Sensors" on page 2.

The *Vantage Pro2 Quick Reference Guide* included with your station provides an easy to use reference for most console functions.

Console Features

Keyboard & Display

The keyboard lets you view current and historical data, set and clear alarms, change station models, enter calibration numbers, set up and view graphs, select sensors, and read the forecast. The keyboard consists of 12 command keys located next to the screen display and four navigation keys located below the command keys.

A weather variable or console command is printed on each command key. Just press a key to select the variable or function printed on that key.



Each command key also has a secondary function which is printed above the key on the console case. To select the secondary function, press and release 2ND (on the front of the console, upper right corner) and then immediately press the key for that function.



Note: After pressing 2ND, the 2ND icon displays above the barometer reading on the screen for three seconds. All secondary key functions are enabled during this time. Keys resume normal operation after the icon disappears.

The up arrow, down arrow, left arrow, and right arrow navigation keys are used to select command options, adjust values, and to provide additional functions when used in combination with a command key.



Console Modes

The console operates in five basic modes: Setup, Current Weather, Highs and Lows, Alarm, and Graph. Each mode lets you to access a different set of console functions or to display a different aspect of your weather data.

Vantage Pro Options

Optional Sensors

Vantage Pro2 stations are extremely flexible. Use the following optional sensors and wireless stations to enhance the weather monitoring capabilities of your Vantage Pro2. See our website for complete details:

www.davisnet.com.

Optional Sensor and Stations	Description
Wireless Weather Envoy (#6316)	Performs much of the same functions as a Vantage Pro2 console, but without a display. Use Envoy to interface your wireless station to a computer when you'd rather place the console in another location for viewing weather conditions
Anemometer Transmitter Kit (#6332)	Provides more flexible anemometer placement for wireless stations.
Wireless Leaf & Soil Moisture/ Temperature Station (#6345)	Measures and transmits leaf wetness, soil moisture and temperature data. For use with GLOBE.
Wireless Temperature Station (#6372)	Measures and transmits temperature data.
Wireless Temperature/Humidity Station (#6382)	Measures and transmits air temperature and humidity data.
Solar Radiation Sensor (# 6452)	Measures solar radiation. Required for calculating evapotranspiration (ET). Available for cabled and wireless stations. Requires Sensor Mounting Shelf (#6672).
Ultraviolet (UV) Radiation Sensor (#6490)	Measures UV radiation. Required for calculating the UV dose. Available for Cabled and Wireless stations. Requires Sensor Mounting Shelf (#6672).

Note: Optional wireless stations can only be used with Wireless Vantage Pro2 Stations.

Optional WeatherLink® Software

The WeatherLink software and data logger connect your Vantage Pro2 station directly to a computer, providing enhanced weather monitoring capabilities and powerful internet features. The WeatherLink data logger fits neatly on the console and stores weather data even when the computer is turned off.

WeatherLink Option	Description
WeatherLink for Windows, USB connection (#6150USB)	Includes WeatherLink software and USB data logger. Allows you to save and view your weather data on your PC.
WeatherLink for Windows, serial connection (6150SER)	Includes WeatherLink software and serial data logger. Allows you to save and view your weather data on your PC.

WeatherLink Option	Description
WeatherLink for Macintosh OS X, USB connection (#6520C)	Includes WeatherLink software and USB data logger. Allows you to save and view your weather data on your Mac.
WeatherLink for APRS, Windows version, with streaming data logger, serial connection (#6540)	Includes WeatherLink software and streaming serial data logger. Allows real-time display of current weather conditions for use with APRS (Automatic Position Reporting System), for HAM radio users.
WeatherLink for Emergency Response teams, Windows version, with streaming data logger, serial connection (#6550)	Includes WeatherLink software and streaming serial data logger. Allows real-time display of current weather conditions for use by Emergency Response teams.
WeatherLink for Irrigation Control, Windows version, with streaming data logger, serial connection (#6560)	Includes WeatherLink software and streaming serial data logger. Allows intelligent and efficient control of popular automated irrigation systems using weather data.

Optional Accessories

The following accessories are available from your dealer or may be ordered directly from Davis Instruments.

Sensor Mounting Shelf (#6672)

Required for mounting the optional Solar Radiation and/or UV sensors. The mounting shelf attaches to the base of the rain collector on the ISS.

Car/Boat/RV Lighter Cord (#6604)

Allows the Vantage Pro2 console and ISS to draw power from a standard car cigarette lighter if the ISS is connected to the console using a cable.

USB-to-Serial (DB-9) Cable (#8434)

Allows the Serial version of WeatherLink (6510SER, 6540, 6550, 6560) to connect to a USB port on your computer.

Telephone Modem Adapter (#6533)

Creates a dialup connection between the station and the computer.

Extension Cables (#7876)

Allows you to place the Cabled Vantage Pro2 ISS further away from the console using the extension cable provided by Davis Instruments. Maximum cable length is 1000' feet (300 m).

- #7876-040 Cable, 40' (12 m)
- #7876-100 Cable, 100' (30 m)
- #7876-200 Cable, 200' (61 m)

Davis Baseball Cap (#PR725)

100% cotton twill cap is two-toned with a washed khaki crown, dark blue brim, and embroidered Davis logo. Self-fabric closure with brass buckle. One size fits all.

Chapter 2

Installing the Console

The Vantage Pro2 console is designed to give extremely accurate readings. As with any precision instrument, use care in its assembly and handling. Although installing the console is relatively simple, following the steps outlined in this chapter and assembling the Vantage Pro2 correctly from the start will help ensure that you enjoy all of its features with a minimum of time and effort.

Powering the Console

Cabled Vantage Pro2 Stations

Cabled Vantage Pro2 consoles supply power to the Integrated Sensor Suite (ISS) through the console cable. Because of the added power consumption of the ISS, the cabled console requires an AC power adapter or optional Car/Boat/RV Lighter Cord for the main power supply. The console batteries provide backup power for up to four to six weeks.

Wireless Vantage Pro2 Stations

Wireless Vantage Pro2 consoles do not require the use of an AC adapter. You may use the included adapter if you wish, but the three C-cell batteries should power a wireless console for up to nine months.

Note: When using an AC Power adapter, be sure to use the power adapter supplied with your Vantage Pro2 Console. Your console may be damaged by connecting the wrong power adapter. The console does not recharge the batteries. Because of this, and because NiCad batteries do not power the console as long as alkaline batteries, use alkaline batteries in the console.

Installing the AC Power Adapter

1. Remove the battery cover located on the back of the console by pressing down on the two latches at the top of the cover.
2. Find the power jack located on the bottom of the console case.

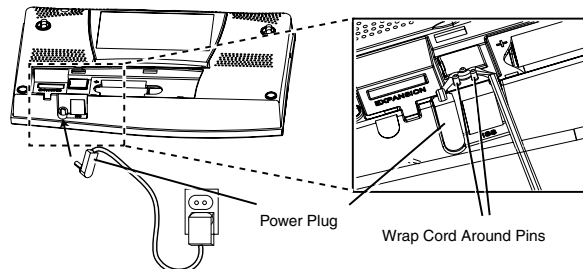

3. Insert the power adapter plug into the console power jack, then plug the other end of the adapter into an appropriate power outlet.
4. Check to make sure the console runs through a brief self-test procedure successfully. On power up, the console displays all the LCD segments and beeps twice. A message displays in the ticker banner at the bottom of the console, followed by the first screen that displays during Setup Mode. Press DONE to skip the message and enter into Setup Mode.

Setup Mode guides you through steps required to configure the station. See "Setup Mode" on page 9 for more information.

Installing Batteries

1. Remove the battery cover located on the back of the console by pressing down on the two latches at the top of the cover.

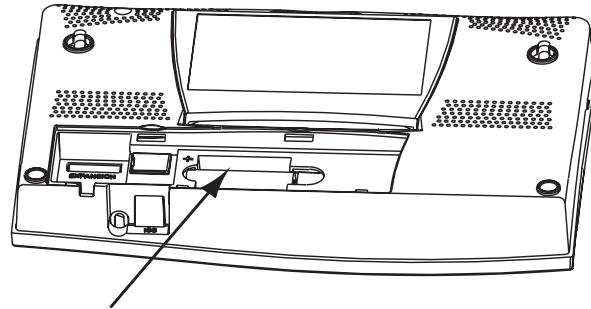

2. Insert three C batteries into the battery channel, negative (or flat) terminal first.
3. Replace the battery cover.

Connecting Cabled Stations

Cabled Vantage Pro2 stations come with 100 feet (30m) of cable. This cable is used for connecting the console to the ISS. Maximum cable length from ISS to the console using Davis Instruments cables is 1000 feet. To connect the console to the ISS:

1. Firmly insert the console end of the straight-through four-conductor wire into the console receptacle marked "ISS" until it clicks into place. Do not force the connector into the receptacle

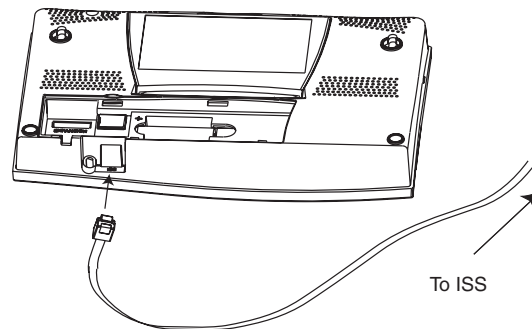

2. Ensure that the ISS cable is not twisted through the access port.

Note: The ISS must be assembled and connected to the console so that it is receiving power before the console connection can be tested.

Once the console and ISS are both powered up, cable connection should be tested and established.

Once the console is powered, it automatically enters Setup Mode. You can step through the Setup Mode options, or exit the Setup Mode to test the connection and sensor readings in Current Weather Mode. See “Setup Mode” on page 9 for Setup Mode options. See “Current Weather Mode” on page 20 for viewing and verifying current weather data coming from the cabled console.

To verify that the console is receiving data from the ISS through the console connection, see “Cabled ISS Assembly” in the Integrated Sensor Suite Installation Manual.

Console Location

You should place the console in a location where the keyboard is easily accessible and the display is easy to read. For more accurate readings, follow these suggestions.

- Avoid placing the console in direct sunlight. This may cause erroneous inside temperature and humidity readings and may damage to the unit.
- Avoid placing the console near radiators or heating/air conditioning ducts.
- If you are mounting the console on a wall, choose an interior wall. Avoid exterior walls that tend to heat up or cool down depending on the weather.
- If you have a wireless console, be aware of possible interference from cordless phones or other devices. To prevent interference, maintain a distance of 10 feet between the Vantage Pro2 console and a cordless phone (handset and base).

- Avoid positioning a wireless console near large metallic surfaces such as refrigerators.

Table & Shelf Placement

The console kickstand can be set to three different angles allowing five different display angles.

1. Install the two round rubber feet on the bottom of the console. The rubber feet help prevent damage to furniture and surfaces.

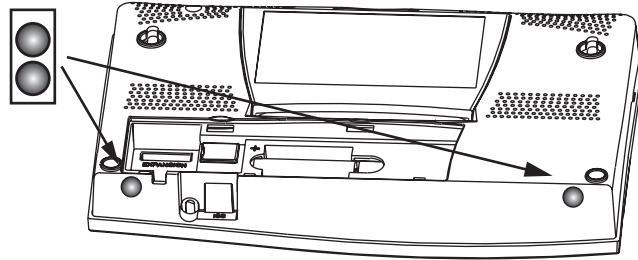

2. Lean the kickstand out by pulling on its top edge

You'll see the indentation for your finger at the top edge of the console.

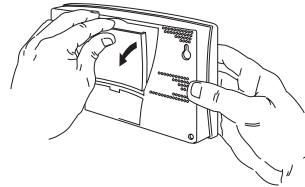

3. Slide the catch to rest the kickstand in the appropriate angle.

Choose low angles for display on a coffee table or other low area. Choose higher angles for display on a desk or shelf.

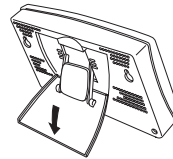

4. Install the two rubber channel feet on the kickstand.

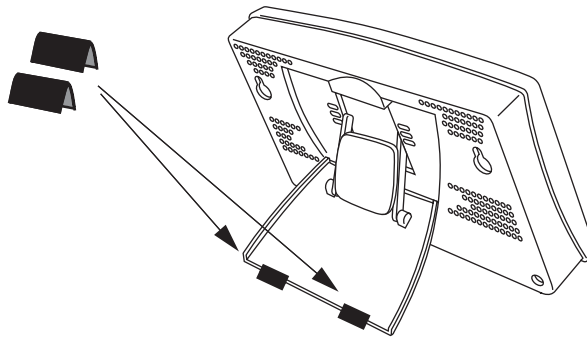

If necessary, pull up on the stand to close it. It will be a little tight, so it's okay to push hard enough to get it to slide.

Wall Mounting

The console mounts to the wall using two keyholes located on the back of the case.

To mount the console on a wall:

1. Use a ruler to mark two mounting hole positions on the wall 8 inches (203 mm) apart.

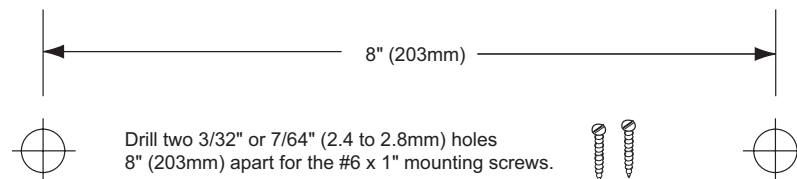

This is a representation for the mounting hole positions. This template is not true to size.

If installing a standard Vantage Pro2 console with sensor cable running inside the wall, mount the console over an empty switch box.

2. Use a drill and a 3/32 or 7/64" (2.5 mm) drill bit to drill two pilot holes for the screws.
3. Using a screwdriver, drive the two #6 x 1" pan head self-threading screws into the wall. Leave at least 1/8" (3 mm) between the wall the heads of the screws.
4. If the kickstand has been pulled out from the case, push it back into its upright and locked position.
5. Guide the two keyholes on the back of the console over the two screw heads

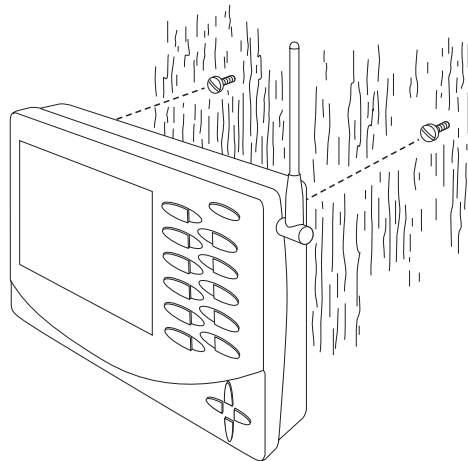

Chapter 3

Using Your Weather Station

The console LCD screen and keyboard provide easy access to your weather information. The large LCD display shows current and past environmental conditions as well as a forecast of future conditions. The keyboard controls console functions for viewing current and historical weather information, setting and clearing alarms, changing stations types, viewing and/or changing station settings, setting up and viewing graphs, selecting sensors, getting the forecast, and so on.

Console Modes

The Vantage Pro2 console operates in five different modes:

Mode	Description
Setup	Use Setup Mode to enter the time, date, and other information required to calculate and display weather data.
Current Weather	Use Current Weather Mode to read the current weather information, change measurement units, and to set, clear or calibrate weather readings.
High/Low	High/Low Mode displays the daily, monthly or yearly high and low readings.
Alarm	Alarm Mode allows you to set, clear, and review alarm settings.
Graph	Graph Mode displays your weather data using over 100 different kinds of graphs.

Setup Mode

Setup Mode provides access to the station configuration settings that control how the station operates. Setup Mode consists of series of screens for selecting console and weather station options. The screens that display in Setup Mode vary depending on the weather station type (cabled or wireless), or if the console has a WeatherLink connection already established. See the WeatherLink Getting Started Guide for more information on connecting your console to your computer.

Setup Mode Commands

Setup Mode displays when the console is first powered up. This mode can be displayed at any time to change any of the console/weather station options. Use the following commands to enter, exit and navigate Setup Mode:

- Enter Setup Mode by pressing DONE and the down arrow (-) at the same time.

Note: The console automatically enters Setup Mode when first powered.

- Press DONE to move to the next screen in the Setup Mode.
 - Press BAR to display the previous screen in the Setup Mode.
-

- Exit Setup Mode by pressing and holding DONE until the Current Weather screen displays.

Screen 1: Active Transmitters

Screen 1 displays the message “Receiving from...” and shows the transmitters being received by the console. In addition, an “X” blinks in the lower right-hand corner of the screen every time the console receives a data packet from a station. The rest of the LCD screen is blank.

If you have a cabled station, or if your wireless ISS uses the factory settings and you are receiving the signal, the screen displays “Receiving from station No. 1”. Any optional stations that have been installed should also display.

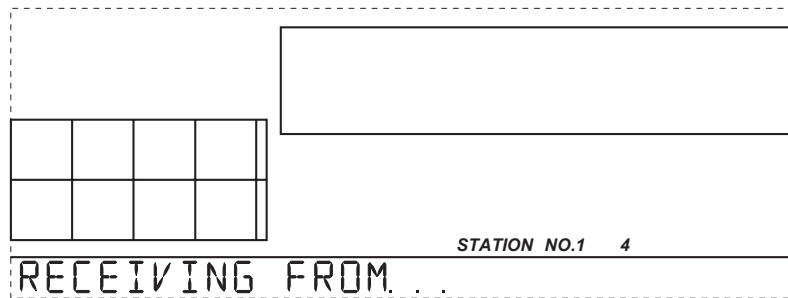

Screen 1: Active Transmitters

Note: An ISS or optional station must be powered for the console to recognize it. Refer to the Integrated Sensor Suite Installation manual or optional station installation instructions for more information.

1. Make a note of the station number(s) listed on the screen.
2. Press DONE to move to the next screen.

The console can receive signals from up to eight transmitters total, but there is also a limit on the number of certain types of transmitters. The table below lists the maximum number for each type of transmitter:

Transmitter Type	Maximum Number
Integrated Sensor Suite (ISS)	1
Anemometer Transmitter Kit	1
Leaf & Soil Moisture/Temperature Station	2
Temperature Station	8
Temperature/Humidity Station	8

Maximum Number of Transmitters

Note: Listening to more than one transmitter may reduce battery life significantly.

Screen 2: Configuring Transmitter IDs — Wireless Only

If you have a cabled station, press DONE and see “Screen 4: Time & Date” on page 12.

Setup screen 2 allows you to change the ISS transmitter ID and to add or remove optional transmitter stations. The default setting works fine for most installations. The default transmitter ID setting is “1” (ISS).

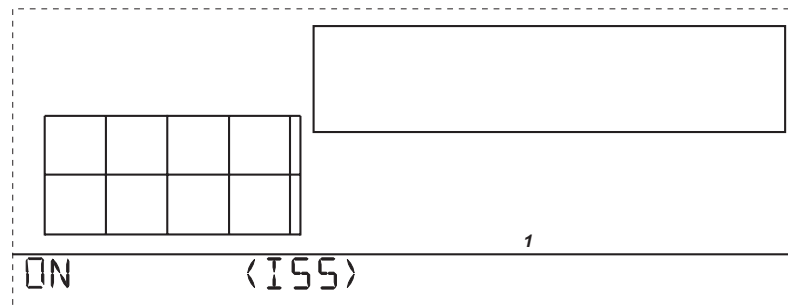

Screen 2: Transmitter ID configuration

If you have a cabled station, or if you have a wireless station and are using the default transmitter ID setting, press DONE to move to the next screen.

Note: Typically, you can use the default transmitter ID setting of 1 unless you are installing one of the optional transmitter stations or a nearby neighbor has a Vantage Pro2 Station that uses transmitter ID 1 for the ISS.

3. Press the right and left arrows to select the transmitter ID.
When you select a transmitter ID, the ID number is displayed on the screen as well as the current configuration.
4. Press the up or down arrows to toggle console reception of signals from transmitters using that ID on and off.
5. Press GRAPH to change the type of station assigned to each transmitter number. Scroll through the station types - ISS, TEMP, HUM, TEMP HUM, WIND, RAIN, LEAF, SOIL, and LEAF/SOIL - until the correct type appears.
6. Press DONE to move to the next screen.

Screen 3: Retransmit — Wireless Only

Press DONE and go to “Screen 4: Time & Date” on page 12 if you have a cabled station.

The console can take data it receives from the ISS and transmit it to other Vantage Pro2 consoles using the retransmit feature. By toggling the feature

on, the console becomes another transmitter that requires its own unique ID to transmit the data received from the ISS.

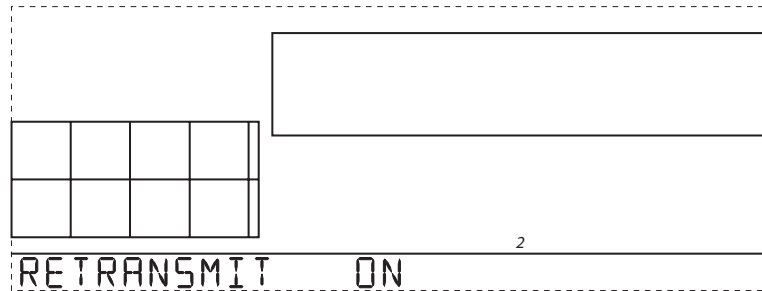

Screen 3: Retransmit

1. Press the up or down arrow to turn the retransmit function on and off. The first available transmitter ID not used by the ISS or any optional sensor is automatically assigned. Data from the ISS is the only data that can be retransmitted by the console.
When retransmit has already been enabled, pressing the right arrow changes the transmitter ID used for retransmit.
2. Use the right arrow to scroll through the list of available transmitter IDs and select the ID for your console.
3. Press DONE to move to the next screen.

Note: Make a note of the ID selected for retransmit. The console that receives the data from the console you have selected to retransmit should be configured to receive the transmitter ID you selected. See "Screen 2: Configuring Transmitter IDs — Wireless Only" on page 11 for more information.

Screen 4: Time & Date

The very first time you power-up the console, the time and date are set to 12:00AM January 1st, 2004. Be sure to enter the correct date and local time.

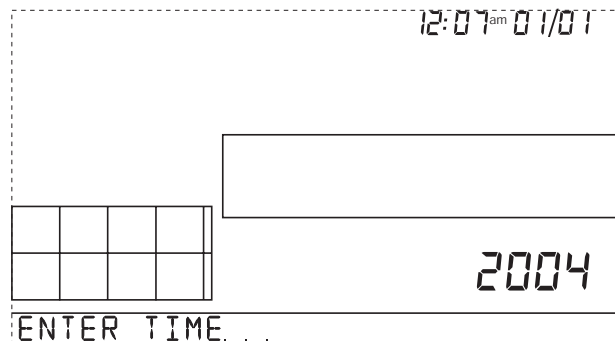

Screen 4: Time & Date

To change the time and date:

1. Press the right and left arrows to select the hour, minute, month, day or year. The selected time or date setting blinks on and off.
2. To change a setting, press the up and down arrows to adjust the value up or down.

To choose a 12-hour or 24-hour clock, first select either the hour or minute setting, then press 2ND and immediately press UNITS. This toggles the clock setting between the two clock types.

To choose between a MM/DD or DD.MM display for the date, first select either the day or month setting, then press 2ND and immediately press UNITS. This switches the console from one date display to the other.

3. Press DONE to move to the next screen.

Screen 5: Latitude

The console uses latitude along with longitude to determine your location, allowing it to adjust the forecast and calculate the times for sunset and sunrise.

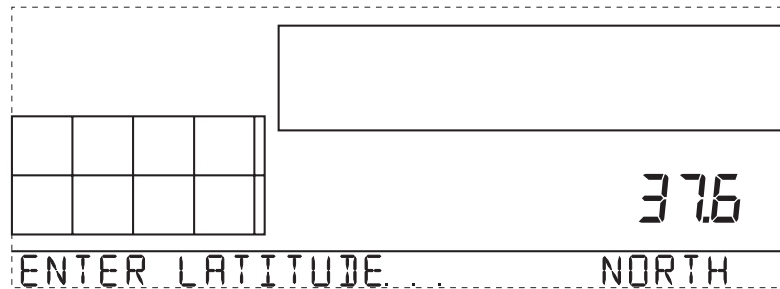

Screen 5: Latitude

- Latitude measures distance north or south of the equator.
- Latitude is used with longitude to identify your position on earth.

If you do not know your latitude and longitude, there are several ways to find out. Many atlases and maps include latitude and longitude lines. You can also talk to the reference department of your local library, call your local airport, or search on the Internet. The more accurate you are, the better; however, a reasonable estimate will work, too.

1. Press the right and left arrows to move between fields.
2. Press the up and down arrows to change the settings up or down.
3. To select the Northern or Southern Hemisphere, press 2ND and then UNITS.
4. Press DONE to move to the next screen.

Screen 6: Longitude

The console uses longitude along with latitude to determine your location, allowing it to adjust the forecast and calculate the times for sunset and sunrise. See Screen 5: Latitude for information on determining your latitude.

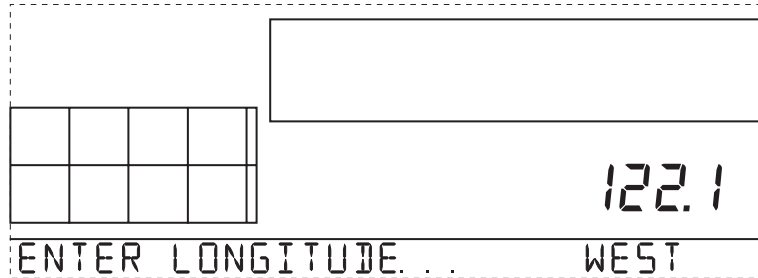

Screen 6: Longitude

- Longitude measures distance east or west of the Prime Meridian, an imaginary line running north and south through Greenwich, England.
- Longitude is used with latitude to identify your position on earth.
 1. Press the right and left arrows to move between fields.
 2. Press the up and down arrows to change the settings up or down.
 3. To select the East or West Hemisphere, press 2ND, then UNITS.
 4. Press DONE to move to the next screen.

Screen 7: Time Zone

The console is pre-programmed with a combination of US time zones and the names of major cities representing time zones around the world. You can also configure your time zone using the Universal Time Coordinate (UTC) offset.

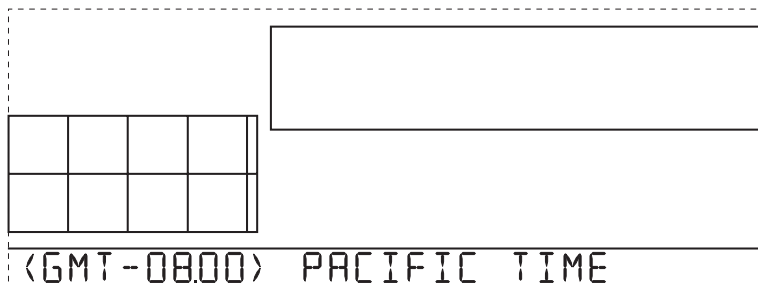

Screen 7: Time Zone

Note: UTC offset measures the difference between the time in any time zone and a standard time, set by convention as the time at the Royal Observatory in Greenwich, England. Hayward, California, the home of Davis Instruments, observes Pacific Standard Time. The UTC offset for Pacific Standard Time is -8:00, or eight hours behind Universal Time (UTC). When it's 7:00 pm (1900 hours) UTC, it's $19 - 8 = 1100$ hours, or 11:00 am in Hayward in winter. When daylight savings time is observed, an hour is added to the offset time automatically. Use this function in correlation with Screen 8.

1. Press the up and down arrows to cycle through time zones.
2. If your time zone is not shown, press 2ND then press the up and down arrows to set your UTC offset.
3. Press DONE to select the time zone or UTC offset shown on the screen and move to the next screen.

Screen 8: Daylight Savings Settings

In most of North America, including Mexico (excepting Saskatchewan, most of Eastern Indiana, Arizona, and Hawaii), as well as in Australia (excepting Western Australia, Northern Territory, and Queensland) and in Europe use the AUTO Daylight Savings setting. The console is pre-programmed to use the correct starting and stopping dates for Daylight Savings Time in these areas, based on the time zone setting in screen 7.

Weather stations located outside of North America, Europe, and Australia or in areas that do not observe daylight savings time should use the MANUAL setting.

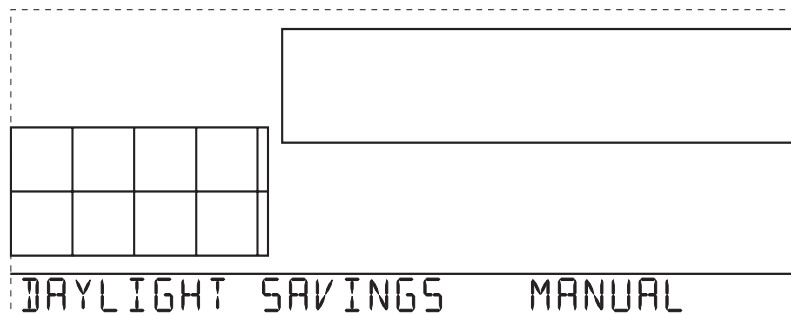

Screen 8: Daylight Savings Settings

1. Press the up and down arrows to choose Auto or Manual.
2. Press DONE to move to the next screen.

Screen 9: Daylight Savings Status

Use this screen to either verify the correct automatic Daylight Savings status or to set Daylight Savings manually.

Screen 9: Daylight Savings Status

1. Press the up and down arrows to turn Daylight Savings Time on or off on the appropriate days of the year, if Day Savings setting is MANUAL. If you have an AUTO Daylight Savings setting, the console display the appropriate setting based on the current time and date.
2. Press DONE to move to the next screen.

Screen 10: Elevation

Meteorologists standardize barometric pressure data to sea level so that surface readings are comparable, whether they're taken on a mountainside or by the ocean. To make this same standardization and ensure accurate readings, enter your elevation in this screen.

Screen 10: Elevation

Note: If you do not know your elevation, there are several ways to find out. Many atlases and almanacs include elevation for cities and towns. You can also check with the reference department of your local library. The more accurate you are, the better; but a reasonable estimate works too.

Setup Mode

1. Press the left and right arrows to move from one numeral in the elevation to another.
2. Press the up and down arrows to adjust a numeral up or down.
3. To switch between feet and meters, press 2ND then press UNITS.
4. If you are below sea level, like in Death Valley or Palm Springs, first enter the elevation as a positive number. Then, select the "0" immediately to the left of the left most non-zero digit (the second zero from the left in 0026, for example, or the first zero from the left in 0207) and press the up and down arrows to switch from a positive to negative elevation.

Note: You can only set the elevation to negative after you have entered a non-zero digit and when the zero in the position immediately to the left of the left-most non-zero digit has been selected.

5. Press DONE to move to the next screen.

Screen 11: Wind Cup Size

Vantage Pro2 Stations come standard with large wind cups. Switch this setting to small only if you have separately purchased and installed small wind cups.

Note: Large wind cups are more sensitive to low wind speeds and are the best choice for most users. Small wind cups are less sensitive at low wind speeds but can measure much higher wind speeds. Install small wind cups if you wish to measure winds over 150 m.p.h. (242 km/h), (Category 5 hurricane). Maximum speed sensitivity decreases with age of the wind cups.

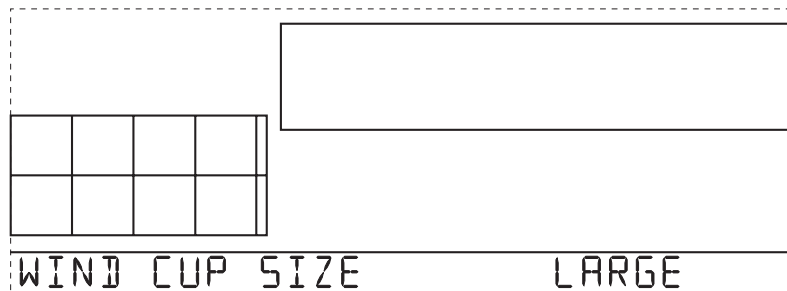

Screen 11: Wind Cup Size

1. Press the up and down arrows to switch between large and small wind cups.
2. Press DONE to move to the next screen.

Screen 12: Rain Collector

The tipping bucket in the Vantage Pro2 rain collector has been calibrated at the factory to measure 0.01" of rain with each tip. The ISS comes equipped with a metric adapter that, once installed, takes 0.2 mm readings for every tip of the bucket. Determine which measurement you want your rain collector to take and configure your console and rain collector accordingly.

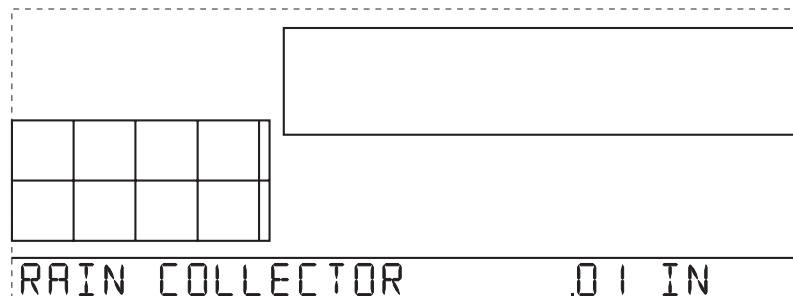

Screen 12: Rain Collector Settings

To configure your console for inch measurements:

1. Press the up and down arrows to display the .01" setting.
2. Press DONE to use the selected setting and move to the next screen.

To configure your console for 0.2 mm measurements:

1. Press the up and down arrows to display the 0.2 mm setting.
2. Press DONE to use the selected setting and move to the next screen.

Note: See the Integrated Sensor Suite Manual for instructions on installing the metric rain adapter. The 0.1mm setting does not provide correct rain measurements with either the standard measurement or the metric adapter installed in the rain bucket.

Note: If necessary, the console can be configured to calculate the 0.01" measurements and convert these to metric measurements, rounding to the nearest 0.1 mm or can be configured to calculate the 0.2 mm measurements and convert them to the U.S. standard, rounding to the nearest .01".

To Display Rain in Metric Units on the Console

Even if you configure to read 0.2 mm measurements set in screen 12 of the Setup Mode, you have to configure your Current Weather Mode to display the same readings. To display metric rain readings in the Current Weather Mode, once you have completed or exited the Setup Mode:

1. Press RAIN_{VR} to display the current rain rate.

Selecting Metric units for one rain variable also sets all the other rain variables to Metric units.



2. Press and release 2ND and press UNITS once.

The units used to display rain data toggle between inches and millimeters each time you repeat this key sequence.



To Display Rain in Metric Units in WeatherLink

Refer to WeatherLink online help for instructions to set the rain collector to 0.2 mm and to select millimeters as the unit for rain.

Screen 13: Rain Season

Because rainy seasons begin and end at different times in different parts of the world, you must specify the month you wish your yearly rain data to begin. January 1st is the default. The date the rain season begins affects yearly rain rate highs and lows.

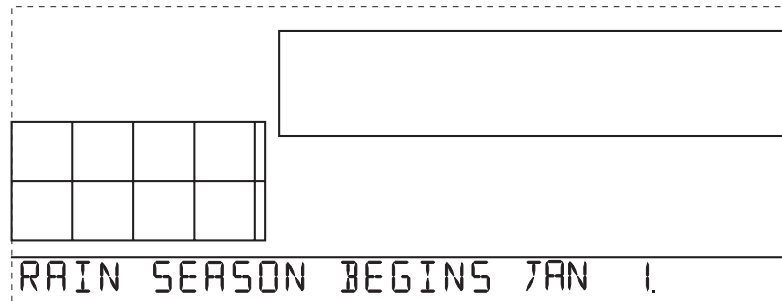

Screen 13: Rain Season

1. Press the up and down arrows to select the month for the start of the rainy season.
2. Press DONE to move to the next screen.

Note: This setting determines when the yearly rain total is reset to zero. Davis Instruments recommends a January rain season setting (the default), unless you reside in the west coast of the United States, the Mediterranean coast, experience dry winters in the Southern Hemisphere, or are performing hydrology studies in any of these climates. If so, change the rain season setting to July 1st.

Screen 14: Serial Baud Rate

The Baud Rate screen displays if the console detects that a WeatherLink data logger installed on the console.

The console uses a serial or USB port to communicate with a computer. If you are connecting the console directly to your computer, leave the setting at 19200, the highest rate for the port. If you're using a modem, use the highest setting your modem can handle. The console must be equipped with a WeatherLink data logger to communicate with a computer.

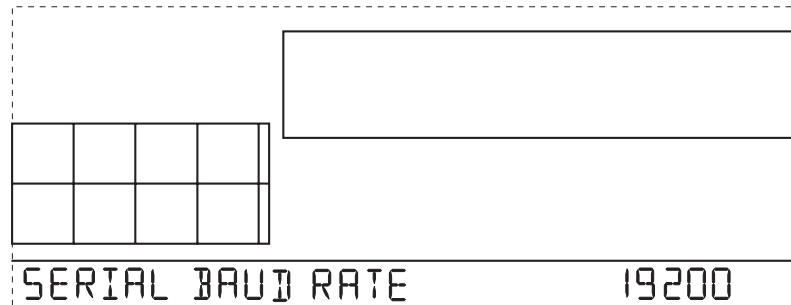

Screen 14: Baud Rate

Note: The baud rate setting on your console must match the serial port setting in the software on your computer. If you are using WeatherLink for Vantage Pro2, refer to WeatherLink help for instructions on setting the serial port baud rate on your computer.

1. Press the up and down arrows to select the baud rate.
Vantage Pro2 supports baud rates of 1200, 2400, 4800, 9600, 14400, and 19200.
2. You have completed the console setup. To exit Setup Mode, press and hold DONE until the current weather screen appears.

Clear All Command

After you have completed the above setup procedures and have exited the Setup Mode, please use the Clear All command before putting your weather station into service.

The Clear All command clears all stored high and low weather data including monthly and yearly highs and lows and clears the alarm settings. The command is recommended to properly clear and initialize the console's data logging function.

1. Press WIND on the console.
2. Press 2ND, then press and hold CLEAR for at least six seconds.
3. Release CLEAR when you see "CLEARING NOW" displayed at the bottom of the console's screen.

Current Weather Mode

In the Current Weather Mode you can display the current data readings from your station, select units of measure, and calibrate, set, or clear weather variables. You can see up to ten weather variables on the screen at the same time, as well as the time and date, the moon and forecast icons, a forecast or special message from your station, and a graph of the currently selected variable. A few variables are always visible on the console screen

while most variables share their location with one or more variables. You can select any variable not currently on the screen to display it.

Selecting Weather Variables

Select a weather variable to display its data on the screen if it isn't already visible or to graph the data available for that variable.

Weather variables are selected via the console command keys:

- If the variable is printed on a key, just press the key to select the variable.
- If the variable is printed on the console housing, first press and release 2ND, then quickly press the key below the variable to select it.



Note: After pressing 2ND, the 2ND icon displays on the screen for three seconds. Command key secondary functions are enabled during this time. The keys return to normal operation after the icon disappears.

- Press a variable and GRAPH to graph the variable in the Current Weather Mode screen. The console places a graph icon on the screen next to the selected variable or value you want to view to indicate the currently selected variable.
- You can also select any variable currently displayed on the LCD screen using the navigation keys. Push up (+) to move up the screen. Press down (-) to move down the screen. Push left (<) to move left and push right (>) to move right.

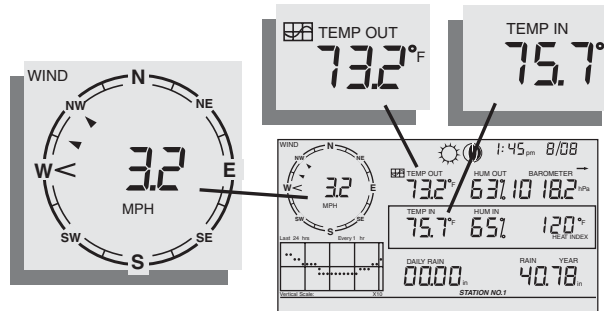

Selecting Units of Measure

Most weather variables may be displayed in at least two different measurement units, including US and Metric systems, although some variables feature more possibilities. Barometric pressure, for example, may be displayed in millibars, millimeters, inches, or hectoPascals. Note that you can set each variable's units independently, and at any time, as you like.

To change units:

1. Select the weather variable.

See “Selecting Weather Variables” on page 21.

2. Press and release 2ND then press UNITS.

The selected variable’s units will change. Repeat steps 1 and 2 until the desired units appear.



For example, to change the Barometric pressure units, first select Barometric pressure by pressing BAR. Next, press and release 2ND, then press UNITS. Repeating these steps cycles through the units available for Barometric pressure: millibars, millimeters, inches, and hectoPascals.



Displaying Units:
Barometric Pressure Units: millibars (mb), millimeters (mm) and inches (in)

Wind Speed and Direction

1. Press WIND to select wind speed.



2. Wind speed may be displayed in miles per hour (m.p.h.), kilometers per hour (km/h), meters per second (m/s), and knots (knots). The 10 minute average wind speed will be displayed in the ticker.

A solid arrow within the compass rose indicates the current wind direction. Arrow caps indicate up to six different 10-minute dominant wind directions to provide a history of the dominant wind directions for the past hour.



3. Press WIND a second time to display the wind direction in degrees instead of the wind speed.

Each additional WIND key press toggles the display between wind speed and wind direction in degrees.

Outside and Inside Temperature

1. Press TEMP to select outside temperature.

Temperature may be displayed in degrees Fahrenheit (°F) or Centigrade (°C). Temperatures can also be displayed in degrees or in tenths of a degree.



2. Press TEMP again to select inside temperature.

Each consecutive press of TEMP displays temperature readings for any optional temperature, temperature/humidity, soil temperature, soil moisture stations also connected to your console. The order the optional sen-

sors readings display depends on your station configuration. Temperatures for temperature stations display, with soil temperature and moisture stations displaying consecutively.

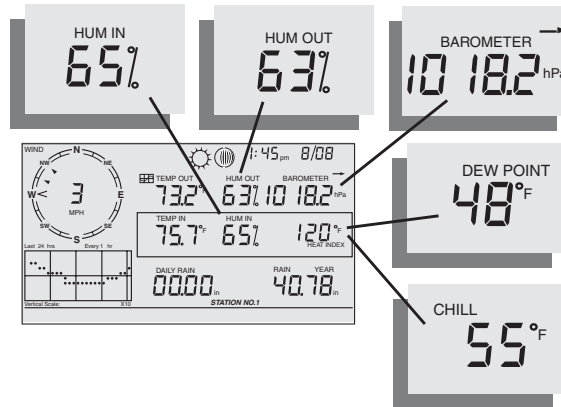

Humidity, Pressure, Dew Point & Wind Chill

Humidity

Press HUM to select outside humidity. Pressing HUM a second time selects inside humidity. Humidity is displayed in percent



Each consecutive press of HUM displays humidity readings for any optional humidity, leaf wetness, and leaf temperature stations also connected to your console. The order the optional sensors readings display depends on your station configuration. Humidity readings for humidity stations display, with leaf wetness and leaf temperature readings displaying consecutively.

Wind Chill

Press 2ND then press CHILL to select Wind Chill.

Wind Chill is displayed in either Fahrenheit (°F) or Centigrade (°C) in whole degrees.



The console uses the ten-minute average wind speed to calculate wind chill.

Dew Point

Press 2ND then press DEW to select Dew Point. Dew Point is displayed in either Fahrenheit (°F) or Centigrade (°C) in whole degrees.



Barometric Pressure

Press BAR to select barometric pressure. Barometric pressure may be displayed in inches (in), millimeters (mm), millibars (mb) or hectoPascals (hPa).



Pressure Trend

The pressure trend arrow indicates the current barometric trend, measured over the last three hours. The pressure trend is updated every 15 minutes. The pressure trend requires three hours of data in order to be calculated so it won't display right away on a new station. The pressure trend is always indicated on the console screen, as long as the required data is available.

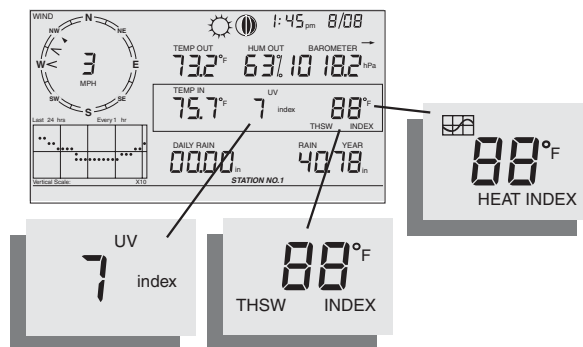

UV, Heat, and THSW Index

UV (Ultraviolet Radiation)

Press 2ND and UV to display the current UV index. The current UV index is the amount of ultraviolet radiation the sensor is currently reading.



Press 2ND and UV again to display the accumulated UV index for the day. The accumulated UV index is the total ultraviolet radiation that the sensor has read throughout the day. The accumulated UV index for the day is reset to zero every night.

Note: Requires a UV sensor. (See "Optional Sensors" on page 2)

Heat Index

Press 2ND then press HEAT to display the Heat Index.



THSW Index

After you have selected the Heat Index, press 2ND then press HEAT again to select the Temperature Humidity Sun Wind (THSW) Index. The THSW Index is only available on stations equipped with a solar radiation sensor.

The Heat Index and the THSW Index display in the same place on the screen and are displayed in degrees Fahrenheit (°F) or Centigrade (°C).

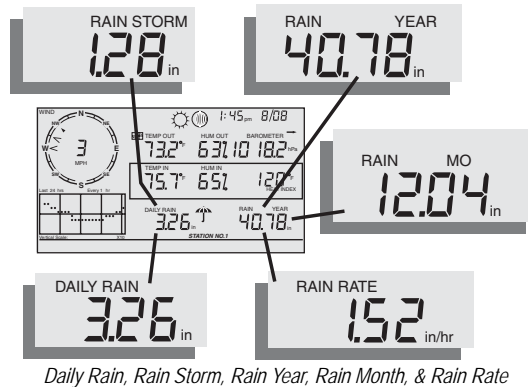

Daily Rain, Rain Storm, Rain Year, Rain Month, & Rain Rate

Rain Rate

Press RAINYR to display the current rain rate. Rain Rate may be displayed as either inches per hour (in/hr) or millimeters per hour (mm/hr). Rain Rate will show zero and the umbrella icon does not appear until two tips of the rain bucket within a 15-minute period.



Month-to-date precipitation

Press RAINYR again to select the month-to-date precipitation record. Monthly rain displays the precipitation accumulated since the calendar month began. Month-to-date precipitation is displayed in inches or millimeters (mm).

Year-to-date precipitation

Press RAINYR a third time to display the year-to-date precipitation record. Yearly rain displays the precipitation accumulated since the 1st of the month you've chosen as the beginning of your rain year in Setup Mode (See "Screen 13: Rain Season" on page 19). Year-to-date precipitation is displayed in inches (in) or millimeters (mm).

Daily Rain

Press RAINDAY to display the rain accumulated since 12 midnight. Any rain accumulated in the last 24 hours displays in the ticker at the bottom of the screen.



Rain Storm

Rain Storm displays the rain total of the last rain event. It takes two tips of the rain bucket to begin a storm event and 24 hours without rain to end a storm event.

Press RAINDAY to toggle between the daily rain total and the Rain Storm total. Rain accumulation may be displayed as either millimeters (mm) or inches (in).

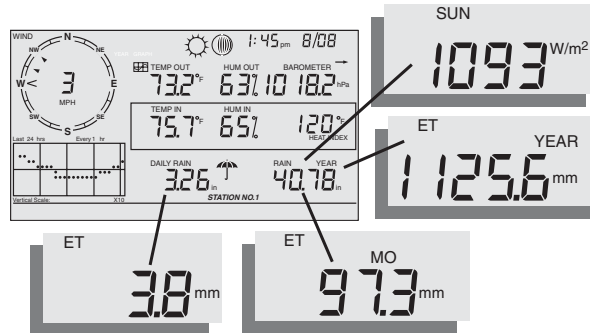

Solar Radiation, Current ET, ET Month & ET Year

Solar Radiation

Press and release 2ND then press SOLAR to display the current solar radiation reading. Solar radiation is displayed as Watts per square meter (W/m^2).



Current Evapotranspiration (ET)

Press and release 2ND then press ET to display the current evapotranspiration reading.



Monthly Evapotranspiration (ET)

Press 2ND then press ET, then repeat this key sequence to display Monthly ET.

Yearly Evapotranspiration (ET)

Press 2ND then press ET, then repeat this key sequence two more times to display the ET reading since January 1st of the current year.

Note: A solar radiation sensor is required to take all of the readings listed above. (See "Optional Sensors" on page 2)

Lamps

Press 2ND then press LAMPS to turn on the backlight for the screen display. Press 2ND then LAMPS again to turn the backlight off.



Use the backlight when the LCD is not clearly visible. When the console is battery operated, the backlight remains on as long as keys are pressed or a ticker tape message is scrolling across the screen. It automatically turns off about ten seconds from the last key press. When battery power is low, the backlight does not light.

Note: When the console receives power from the AC adapter, the backlight remains on until it is toggled off. Leaving the backlight on raises the inside temperature reading and lowers the inside humidity reading.

Displaying the Forecast

Your console generates a weather forecast based on the barometric reading & trend, wind speed & direction, rainfall, temperature, humidity, latitude & longitude, and time of year. Included in the forecast is a prediction of the sky condition (sunny, cloudy, etc.) and changes in precipitation, temperature, wind direction or wind speed.

Press FORECAST to display the forecast. The forecast ticker message at the bottom of the screen predicts the weather up to 48 hours in advance. The forecast is updated once an hour, on the hour. Predictions are made for cloud cover, temperature trends, the likelihood of precipitation, timing, severity and windy conditions.

FORECAST

Forecast Icons

The forecast icons show the predicted weather for the next 12 hours. If rain and/or snow is possible but not necessarily “likely”, the partly cloudy icon along with the rain or snow icon displays. When both the rain and snow icons display together, a chances of rain, freezing rain, sleet and/or snow are likely.

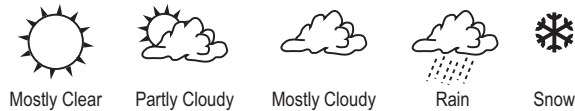

Displaying Time & Date or Sunrise & Sunset

Your console shows the sunrise and sunset time in the same place on the screen used by the current time and date.

Press 2ND and then press TIME to toggle the screen between the current time and date or the sunrise and sunset times for the current day

Note: See “Screen 4: Time & Date” on page 12 to change the console time and date or to select a 12- or 24-hour clock.

Calibrating, Setting, and Clearing Variables

To fine-tune your station, you can calibrate most of the weather variables. For example, if your outside temperature seems consistently too high or too low, you can enter an offset to correct the deviation.

Calibrating Temperature And Humidity

You can calibrate inside & outside temperature, inside & outside humidity, as well as any extra temperature/humidity sensor readings you have transmitting to your Vantage Pro2.

1. Select a variable to be calibrated. See “Selecting Weather Variables” on page 21.
2. Press and release 2ND, then press and hold SET.

2ND

SET
ALARM

After a moment, the variable you’ve selected begins to blink. Keep holding SET until the Calibration Offset message displays in the ticker.

The ticker displays the current calibration offset.
3. Press the up or down arrows to add or subtract from the temperature offset value.

Inside and outside temperature are calibrated in 0.1° F or 0.1° C increments, up to a maximum offset of +12.7 (°F or °C) and a minimum offset of -12.8 (°F or °C). The variable will change value and the ticker will show the offset you’ve entered.
4. Press DONE to exit calibration.

Calibrate Wind Direction Reading

You can use this procedure to correct the anemometer reading. This is useful if the anemometer does not point north in your installation.

1. Check the current direction of the wind vane on the anemometer. Compare it to the wind direction reading on the console. If the wind vane is pointing south, for instance, the wind direction reading on the screen should be 180°.
 - If the wind direction reading is greater than 180°, subtract 180 from the reading and subtract the amount of the offset from the wind direction reading.
 - If the wind direction reading is less than 180°, subtract the reading from 180 and add the amount of the offset to the wind direction reading.
2. Press WIND as necessary to display the wind direction in degrees.
3. Press and release 2ND, then press and hold SET.
4. The wind direction variable will begin to blink.
5. Continue holding the key until the CAL message appears in the ticker.

Note: The ticker displays the current wind direction calibration value.

6. Press the right or left arrows to select digits in the anemometer’s current reading.
 7. Press the up and down arrows to add or subtract from the anemometer reading.
 8. Repeat steps 4 and 5 until you have entered the offset value from Step 1.
 9. Press DONE to exit calibration.
-

Calibrating Barometric Pressure

Before calibrating the barometric pressure, be sure the station is set to the correct elevation.

1. Press BAR to select barometric pressure.
2. Press and release 2ND, then press and hold SET.
The pressure variable blinks.
3. Continue holding the key until the ticker reads “set barometer . . .”.
4. Press the right and left arrows to select digits in the variable.
5. Press up and down arrows to add to or subtract from the digit’s value.
6. Press DONE to exit calibration.

Setting Weather Variables

You can set values for the following weather variables:

- **Daily Rain** - Sets the daily rain total. Monthly and yearly rain totals are updated.
- **Monthly Rain** - Sets the current months total rain. Does not affect yearly rain total.
- **Yearly Rain** - The sets the current year’s rain total.
- **Daily ET (Evapotranspiration)** - This sets the daily ET total. Monthly and yearly ET totals are updated.
- **Monthly ET** - This sets the current month’s ET. Does not affect yearly total.
- **Yearly ET** - This sets the current year’s total ET.

To set a weather variable’s value:

1. Select the variable you wish to change.
2. Press and release 2ND, then press and hold SET. The variable blinks.
3. Keep holding SET until all digits are lit and only one digit is blinking.
4. Press the right or left arrows to select digits in the value.
5. Press the up and down arrows to add to or subtract from the selected digit.
6. When you are finished, press DONE to exit.

Clearing Weather Variables

The following weather variables can be cleared:

- **Barometer** - Clearing the barometer value clears any pressure offset used to calibrate the station, and the elevation entry.
- **Wind** - Clears the wind direction calibration.

- **Daily rain** - Clearing the daily rain value is reflected in the daily rain total, the last 15 minutes of rain, the last three hours of rain sent to the forecast algorithm, the umbrella icon, and the monthly and yearly rain totals. Clear the daily rain total if the station accidentally recorded rain when the ISS was installed.
- **Monthly rain** - Clears the monthly rain total. Does not affect yearly rain total.
- **Yearly rain** - Clears the yearly rain total.
- **Daily ET** - Clears daily ET and subtracts the old daily ET total from the monthly and yearly ET totals.
- **Monthly ET** - Clears the current monthly ET total. Does not affect the yearly ET total.
- **Yearly ET** - Clears the current yearly ET total.

To clear a single weather variable:

1. Select the weather variable.

See “Selecting Weather Variables” on page 21.

2. Press and release 2ND, then press and hold CLEAR.

The variable you’ve chosen blinks. Keep holding the key until the value changes to zero or, in the case of the barometer, the raw barometer value. Clearing the barometer value also clears the elevation setting.

Clear All Command

This command clears all stored high and low weather data including monthly and yearly highs and lows and clears alarm settings all at once:

1. Press WIND on the console.
2. Press 2ND then press and hold CLEAR for at least six seconds.
3. Release CLEAR when “CLEARING NOW” displays at the bottom of the console’s screen.

Highs and Lows Mode

The Vantage Pro2 records highs and lows for many weather conditions over three different periods: days, months, and years. Except for Yearly Rainfall, all high and low registers are cleared automatically at the end of each period.

For example, daily highs are cleared at midnight, monthly highs are cleared at month-end midnight, yearly highs are cleared at year-end midnight. You may enter the month that you would like the Yearly Rainfall accumulation to clear. The Yearly Rainfall clears on the first day of the month you chosen. The Yearly High Rain rate clears using the same setting. The following table lists the high and low modes for all the weather variables:

Highs and Lows Mode

Weather Variable	High	Low	Day, Time & Date	Month	Year	Additional Information
Outside Temperature	Yes	Yes	Yes	Yes	Yes	
Inside Temperature	Yes	Yes	Yes	Yes	Yes*	
Outside Humidity	Yes	Yes	Yes	Yes	Yes*	
Inside Humidity	Yes	Yes	Yes	Yes	Yes*	
Barometer	Yes	Yes	Yes	Yes	Yes*	
Heat Index	Yes		Yes	Yes	Yes*	
Temp/Hum/Wind/Sun (THSW) Index	Yes		Yes	Yes	Yes*	requires solar radiation sensor
Wind Chill		Yes	Yes	Yes	Yes*	
Wind Speed	Yes		Yes	Yes	Yes	Includes direction
Rainfall Rate	Yes		Yes	Yes	Yes	
Daily Rain			Total	Total	Total	
UV Index	Yes		Yes	Yes**	Yes*	requires UV sensor
Solar Radiation	Yes		Yes	Yes**	Yes*	requires solar radiation sensor
Dew Point	Yes	Yes	Yes	Yes	Yes*	
Evapotranspiration			Total	Total	Total	requires solar radiation sensor
Soil Moisture	Yes	Yes	Yes	Yes	Yes*	requires soil moisture sensor
Leaf Wetness	Yes	Yes	Yes	No	Yes*	requires leaf wetness sensor

* Only stores the yearly high for the current year.

** Only stores monthly high for the current month.

Weather Data Highs and Lows

Viewing Highs and Lows

1. Press HI/LOW to enter the Highs and Lows mode.

The DAY and HIGHS icons light up and the station displays the highs for all visible fields.

2. Press the up and down arrows to scroll between Day Highs, Day Lows, Month Highs, Month Lows, Year Highs and Year Lows.

The HIGH or LOW icon, as well the DAY, MONTH or YEAR icon lights to display which High/Low screen you've selected.

3. Press the left and right arrows to scroll back and forth through the last 24 values.

Pressing the left arrow displays the previous day's highs. Each time you press the left arrow, the date moves back another day. The 24 dots in the graph field also represent each of the last 24 days, months, or years; the right-most dot is the present day. As you move backward and forward the flashing dot changes to show what value you're looking at.

4. Use the console keys to select a different weather variable.
The console's time display shows the time of the selected variable's high or low.
5. Press DONE to exit the Highs and Lows mode. The console screen switches to the Current Weather mode.

Alarm Mode

The Vantage Pro2 features more than 30 alarms that can be programmed to sound whenever a reading exceeds a set value. With the exception of barometric pressure and time, all alarms sound when a reading reaches the alarm threshold. For example, if the high outside temperature alarm threshold is set at 65° F, the alarm will sound when the temperature rises to 65.0° F.

When an alarm condition exists, the audible alarm sounds, the alarm icon blinks repeatedly, and an alarm description appears in the ticker at the bottom of the screen. The alarm sounds for a maximum two minutes if the console is battery-powered, but the icon will continue to blink and the message will stay in the ticker until you clear the alarm or the condition clears. If you're using the AC adapter, the alarm will continue sounding as long as the condition exists.

The alarm will sound again for each new alarm. If more than one alarm is active, the description for each active alarm cycles onto the screen every four seconds. A "+" symbol appears at the end of the alarm text if more than one alarm is tripped.

Low alarms work the same way. For example, if the wind chill threshold is set for 30°F, the alarm condition begins when the wind chill drops to 30° and will continue until the wind chill rises above 30°.

Four Special Alarms

ET (Evapotranspiration)

ET is updated only once an hour, on the hour. If during a given hour the ET Value exceeds the alarm threshold, the ET alarm sounds at the end of that hour. This is true for daily, monthly, and yearly ET alarms. You must have the optional Solar Radiation Sensor to use this alarm. See "Evapotranspiration (ET)" on page 48 for a description of this variable.

Barometric Pressure

The Vantage Pro2 allows you to set two barometric pressure alarms: a "rise" alarm and a "fall" alarm. You may select any rate of change per three hours between 0.00 and 0.25 inches (6.35 mm) Hg, (8.5 mb, hPa); the alarm will sound if the rate of change (in either direction) exceeds the threshold you set. This alarm is updated every 15 minutes.

Time

The time alarm is a standard “alarm clock” alarm. It sounds for one minute at the set time. Make sure you choose AM or PM, if you’re in 12-hour mode.

UV Dose

The UV dose alarm sounds when the accumulated UV dose has exceeded the dose you set. The UV dose alarm does not arm unless the initial UV dose for the day has been reset. Once the UV dose alarm value is set, clear the accumulated UV dose. See “Clearing Weather Variables” on page 29.

Setting Alarms

1. Press ALARM to enter the Alarm Mode to view or set the high alarm thresholds. The screen displays the current high alarm thresholds. The ALARM and HIGHS icons also appear.
2. Press the right and left arrows to select one of the variables displayed on the screen or use the console keys to select any weather variable. Also, press HI/LOW to display the toggle between the high and low alarm threshold settings.
3. Press 2ND then press ALARM to activate the currently selected weather variable.
4. Press the right and left arrows to select digits in the threshold value.
5. Press the up and down arrows to change the digit’s value up and down.
6. Press DONE to finish changing the alarm setting.
7. Repeat steps 3 through 6 to change additional alarm settings.
8. Press DONE to exit Alarm Mode.

Setting the Time Alarm

1. Press ALARM to enter alarm mode.
The ALARM and HIGHS icons appear.
2. Press 2ND, then press TIME, then press 2ND again, and then press ALARM.
The time field begins blinking.
3. Press the left and right arrows to select hours, minutes, or AM/PM.
4. Press up and down arrows to change the digit’s value up and down.
5. Press DONE to exit Alarm Mode.

Clearing Alarm Settings

1. Press ALARM to enter alarm mode.
The ALARM and HIGHS icons appear.
2. Select the alarm setting you wish to clear.
3. Press 2ND, then press and hold CLEAR until the setting changes to all dashes.

You have cleared the alarm setting.

4. Press DONE to exit Alarm Mode.

Silencing Alarms

1. Press DONE to silence an alarm when it sounds.

Vantage Pro Station Alarms

Variable	Alarms
Barometric Pressure Trend	Storm Warning - uses trend value rising rate Storm Clearing - uses trend value falling rate
Evapotranspiration	ET Alarm - uses total ET for the day
Humidity, Inside	High and Low
Humidity, Outside	High and Low
Dew Point	High and Low
Leaf Wetness	High and Low
Rain	Flash Flood Alarm - uses current 15 minute rainfall total 24 Hour Rain Alarm - uses current 24 hour rainfall total
Storm	Storm Alarm - uses current storm rainfall total
Rain Rate	High
Soil Moisture	High and Low
Solar Radiation	High
Inside Temperature	High and Low
Outside Temperature	High and Low
Extra Temperature	High and Low
Heat Index Temperature	High
THSW Index Temperature	High
Wind Chill Temperature	Low
UV Radiation Index	High
UV Radiation MED	High - uses the current total if variable has been reset
Wind Speed	High
Time & Date	Yes - the alarm sounds for 1 minute.

Graph Mode

The Vantage Pro2 console includes a powerful Graph Mode that allows you to view over 100 graphs of different kinds right on the screen, all without connecting to a personal computer.

Viewing Graphs

Although the graphs available may vary for each weather variable, you display the graphs in the same way.

1. Press GRAPH to enter Graph Mode.

Only the date, graph, graph icon, and selected variable are visible. The rest of the screen is blank.

2. Select a variable to graph.

Values for the each of the last 24 hours are displayed in the graph, each hour represented by a dot. The dot at right end of the graph is the value for the current hour. You'll notice that the dot is blinking.

3. Press the left arrow and the second dot from the right starts to blink.

The screen displays the new dot's value. The time display shows what hour of the last 24 is being viewed.

4. Press the left and right arrows to view the variable's values for each of the last 24 hours. The console also displays the maximum and minimum temperatures recorded in the last 24 hours.

5. Press the up and down arrows to shift the graph's time span.

If you press the down arrow, the graph shifts from the last 24 hours to the last 24 days. Now each dot represents the high recorded on the day shown in the date field. To see the lows recorded in the last 24 days, press HI/LOW. Press the left and right arrows to move between days.

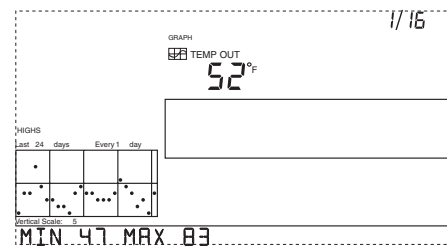
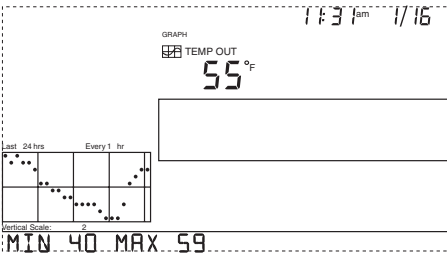

By pressing the down arrow again, the graph shifts to show the highs of the last 24 months. As before, use the right and left arrows to move between months. Press HI/LOW to shift between the highs and lows.

By pressing the down arrow again, the graph shifts one more time to show the highs of the last 24 years. Press HI/LOW to shift between highs and lows.

The console beeps when you've reached the first or last possible value or time span for the graph. Since the console only graphs data collected by the station, the graphs can only show data collected since the station was first installed.

View graphs of all other variables the same way.

1. Select the variable you want to view.
2. Press GRAPH.
3. Use the left and right arrows to select different variables.
4. Press the up arrow to shorten the time range.
5. Press the down arrow to lengthen the time range.
6. Press HI/LOW to shift between highs and lows.
7. Press DONE to exit.

Vantage Pro Console Graphs

Weather Variable	Available Graphs*							
	Current	1 Min	10 Min	15 Min	Hourly	Daily	Monthly	Yearly
Barometric Pressure	C			C	C	H, L	H, L	
Evapotranspiration (ET)**	T				T	T	T	T
Humidity, Inside	C				C	H, L	H, L	
Humidity, Outside	C				C	H, L	H, L	
Dew Point	C				C	H, L	H, L	
Leaf Wetness***	C				C	H, L		
Rain	T			T	T	T	T	T
Storm****								
Rain Rate	H	H			H	H	H	H
Soil Moisture	C				C	H, L		
Solar Radiation**	A				A	H		
Inside Temperature	C				C	H, L	H, L	
Outside Temperature	C				C	H, L	H, L	H, L
Heat Index Temperature	C				C	H	H	
Temp/Hum/Sun/Wind (THSW) Index**	C				C	H	H	
Wind Chill Temperature	L				L	L	L	
UV Radiation Index*****	A				A	H	C	
UV Radiation MED (Minimal Erythral Dose)*****	T				T	T		
Wind Speed	A		A		A, H	H	H	H
Direction of High Wind Speed	Y					Y	Y	Y
Dominant Wind Direction	A				A	A	A	

* A = Average, H = Highs, L = Lows, T=Totals, Y = Yes, C = Current reading at the end of each period

** Requires solar radiation sensor, *****Requires UV sensor

*** Requires Wireless Leaf & Soil Moisture Temperature station

**** Graphs the last 24 storm events and doesn't follow the same graph conventions as other variables.

Chapter 4

Troubleshooting and Maintenance

Vantage Pro2 Troubleshooting Guide

While your Vantage Pro2 weather station is designed to provide years of trouble-free operation, occasional problems may arise. If you are having a problem with your station, please consult this troubleshooting guide before calling Davis technical support. You may be able to quickly solve the problem yourself. If you need help, please see “One Year Limited Warranty” on page 42.

Note: Refer to the ISS Installation Manual for additional troubleshooting information.

TABLE 4-1: TROUBLESHOOTING GUIDE

	Problem	Solution
Display	Display is blank	Unit is not receiving power. Check the power adapter connections and/or replace batteries.
	Display shows dashes in place of weather data	<ul style="list-style-type: none"> ISS not plugged in (cabled station). See ISS manual. Sensors not transmitting (wireless station). See ISS (or other transmitter) manual. Console not receiving (wireless station) - See “Troubleshooting Reception Problems” on page 38. A reading has exceeded the limits indicated in the specifications table. Calibration numbers may be causing readings to exceed display limits. Check calibration number and adjust if necessary.
	Console is sluggish or does not work at low temperatures	The console and display may not work below 32° F (0° C). Use an External Temperature sensor in low-temperature locations or install the console indoors.
	Display “locks up”	If the console “locks up”, reset the console by removing AC and battery power then restoring power. If this occurs frequently in an AC-powered console, plug the AC power-adaptor into a surge suppressor.
Humidity	Inside humidity seems too high or too low	Make sure the console is not near a humidifier or de-humidifier. Check calibration number and adjust if necessary. If inside humidity is low, and inside temperature is too high, see “inside temp” below. Also make sure the console backlight is not on.
Wind Speed	Wind speed reading seems too high or too low.	For low readings, remove the wind cups and check for friction sources. Check the anemometer location. Is it sheltered from the wind? See ISS manual for additional wind speed troubleshooting information.
	Wind speed reads 0 either all the time or intermittently	The problem may be with the anemometer. Test anemometer by spinning wind cups. Check fields one-b and two-b on diagnostic screen and call technical support.

TABLE 4-1: TROUBLESHOOTING GUIDE

	Problem	Solution
Dew	Dew Point reading seems too high or too low	Check calibration numbers for temperature. Remember, dew point depends on temperature and outside humidity. Make sure they're working.
Temperature	Outside temperature sensor reading seems too high	Check calibration number and adjust if necessary. ISS or temp sensor may need to be relocated. See ISS or other transmitter manual.
	Inside temperature sensor reading seems too high	Move the console out of direct sunlight. Make sure that the console or sensor is not in contact with an exterior wall that heats up in sunlight or when outside temperature rises. Make sure the console or sensor is not near a heater or other internal heat source (lamps, appliances, etc.). Also make sure the console backlight is not on. Check calibration number and adjust if necessary.
	Outside temperature seems too low	Check calibration number and adjust if necessary. Sprinklers may be hitting the ISS radiation shield. Relocate. See ISS manual.
	Inside temperature sensor reading seems too low	Make sure the console or other temperature sensor is not in contact with an exterior wall that cools down when outside temperature drops. Make sure the console or other temperature sensor is not near an air conditioning vent. Check calibration number and adjust if necessary.
Wind Direction	Wind direction reading is dashed out	<ul style="list-style-type: none"> Wireless model - check reception. See Reception Problems below. Cabled model - cable may be faulty. If these steps do not reveal the problem, the anemometer may be faulty. Call technical support for return authorization.
	Wind direction always says north	Usually an ISS problem, especially if outside temperature is dashed out as well. See the ISS manual for troubleshooting information
Chill	Wind chill reading seems too high or too low	Check calibration numbers for temperature. Remember, wind chill depends on temperature and wind speed. Make sure they're working.
Heat	Heat Index reading seems too high or too low	Check calibration numbers for temperature. Remember, the heat index depends on temperature and outside humidity. Make sure they're working.
Rain	No rain readings	Make sure cable-tie is removed from rain collector. See the ISS manual.
Time	Incorrect times for sunrise and sunset	Check your latitude, longitude, time zone, and daylight savings time settings. Sunrise and sunset times are calculated from the console using all of these settings.

Troubleshooting Reception Problems

While we have tested the Wireless Vantage Pro2 radio extensively, each site and each installation presents its own issues and challenges. Obstructions, particularly metallic ones, will often cut down your station's reception distance. Be sure to test reception between the console and ISS, in the locations you intend to install them, or before permanently mounting your ISS or other transmitter(s).

The console's reception status displays at the lower right corner of the screen.

- An "X" flashes for every data packet received by the console.
- An "R" is shown when the console is trying to re-establish a lost connection.
- An "L" is shown when the signal has been lost.
- When no data packets have been received for 10 minutes, the console dashes-out any missing sensor readings

Check Console Reception

Enter Setup mode by pressing DONE, then pressing the down arrow. Wait a few moments while the console lists all the stations transmitting within range. If the console does not detect your transmitter, check the following:

- Adjust the console and ISS antennas to be in line of sight with each other.
- Try turning on the Gain. See "Diagnostic Screen Commands" on page 39.
- Reduce the distance between the ISS and the console.
- If the console is directly beneath the ISS, then antennas should be horizontal.
- Try distancing your console from your ISS, at least 10 feet apart.

Check the ISS

Refer to the ISS Installation Manual for instructions on how to check the ISS for potential transmission problems.

Console Diagnostic Screens

In addition to logging weather data, the console continuously monitors the station's radio reception. You may find this information very helpful, especially when you are choosing locations for your console and ISS.

Console Diagnostics consists of two screens, the Statistical Diagnostic screen and the Reception Diagnostic screen. The Statistical Diagnostic screen applies for both cabled and wireless weather stations. The Reception Diagnostic screen applies only to wireless weather stations and is not accessible to a cabled weather station.

Note: Radio transmission data that is used by the diagnostic screens is cleared each day at midnight.

Diagnostic Screen Commands

- Press and hold TEMP, then press HUM to display the Statistical Diagnostic screen.
 - Press DONE to exit the diagnostic screen.
-

- Press the right arrow to display signal statistics for the next installed transmitter ID.
- Press HI/LOW to toggle Gain on and off. The message in the ticker indicates the current Gain status. The Receiver Gain setting provides some control over the receiver sensitivity. If you're having trouble with reception, try turning the Gain on.
- Gain can adversely affect performance when signal strength is high. Gain should generally not be turned on when signal strength is above 30. See "Reception Diagnostic Screen" on page 41.
- Press 2ND and then press CHILL to toggle between the Statistical and Reception Diagnostic screens.
- A degree (°) sign displays in field 1 of the Reception Diagnostic screen to differentiate which screen is currently being displayed.

Statistical Diagnostic Screen

The Statistical Diagnostic displays information about how data is being received from the weather station to the console. The information that is displayed in this screen includes:

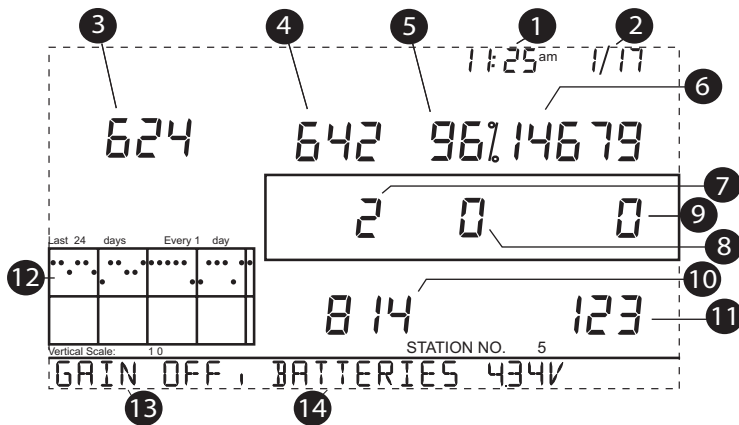

Statistical Diagnostics Screen

1. Time of day. When WIND is pressed, the number of times the reed switch was seen closed is displayed. The reed switch closes once each rotation. Use WIND to toggle between these two values.
2. Date. When WIND is pressed, the number of times the reed switch was seen open is displayed. Use WIND to toggle between these two values.

Note: The time of day and date displays can be toggled in both statistical and reception diagnostic screens.

3. Number of packets containing errors that were received.
4. Number of missed data packets.

5. Percentage of packets received without errors.
6. Total number of packets received.
7. Number of times the console resynchronized with the transmitter.
8. Maximum number of packets missed in a row without resynchronization.
9. Current number of consecutive misses. The counter increments when the console is synchronized but the packet is missed. The console will attempt to resynchronize after 20 consecutive misses.
10. Longest streak of consecutive packets received.
11. Current streak of consecutive packets received.
12. Graph of the percentage of scheduled ISS data packets received over the last 24 days.
13. Receiver Gain status.
14. Current console battery voltage.

Reception Diagnostic Screen

The Reception Diagnostic screen displays information pertinent to the console's wireless reception. To view this screen from the Statistical Diagnostic screen, press 2ND and then press CHILL. The information that is displayed in this screen includes:

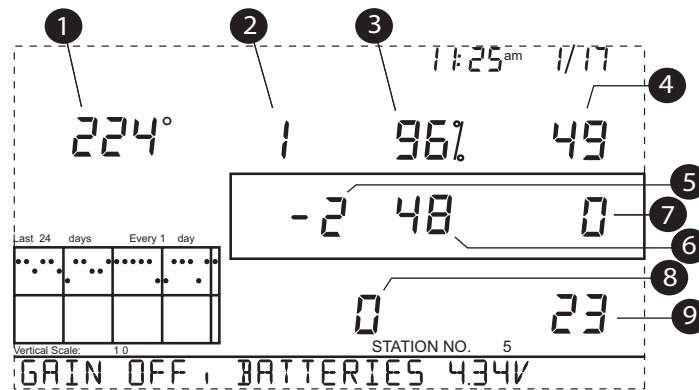

1. 8-bit timer value of next reception. The degree sign displaying in the upper right hand corner next to this value verifies that the Reception Diagnostic screen is currently displayed.
2. Frequency error of the last packet received successfully.
3. Percentage of packets received without errors.
4. Signal strength of the last packet received. The values displayed in this field should generally be between 20 and 60. See "Diagnostic Screen Commands" on page 39 for information on adjusting gain. If a packet is not received successfully, the signal strength field is dashed out (--).

5. Current frequency correction factor.
6. Frequency index of the next packet to be received.
7. Current number of consecutive packets missed.
8. The number of times that the Phase Lock Loop did not lock.
9. Current streak of consecutive packets received.

Console Firmware Versions

In some cases, the problem may be that your console firmware doesn't support what you are trying to do. Use this command to determine the firmware revision level in your console. You can find more information on Vantage Pro2 console firmware versions and changes in the Weather Software Support section of our website. See "One Year Limited Warranty" on page 42 for information.

Press and hold DONE then press the up arrow to display the console firmware version in the ticker at the bottom of the screen.

Console Maintenance

Changing Batteries

Use this procedure to change console batteries without losing any stored weather data or console configuration settings.

1. Plug in the AC adapter or, if the AC adapter is not present, enter Setup Mode by pressing DONE and then the down arrow.
Entering Setup Mode makes sure the station isn't writing any data to memory when power is removed.
2. Remove the battery cover located on the back of the console by pressing down on the two latches at the top of the cover.
3. Place the console face down on a flat, firm surface.
4. Insert a fingertip between the two exposed batteries then press the middle battery down toward the notch (toward the "hidden" battery). This will relieve tension on the first battery and allow you to remove it.
5. Remove the old batteries and install the new batteries.
6. Replace the battery cover and remove the AC power adapter, if it was used.

One Year Limited Warranty

For details on our warranty policy, please refer to the *Maintenance, Service, and Repair Information* brochure included with your station.

Appendix A

Weather Data

Refer to this appendix to learn more about the weather variables that are measured, displayed, and logged by your Vantage Pro2 Station. Some weather variables require optional sensors. See “Optional Sensors” starting on page 2.

Wind

The anemometer measures wind speed and direction, and is part of the Integrated Sensor Suite (ISS). The console calculates a 10-minute average wind speed and 10-minute dominant wind direction. The 10-minute average wind speed is displayed in the console ticker whenever wind has been selected on the console. The last six 10-minute dominant wind directions are included in the compass rose wind display.

Temperature

The ISS houses the outside temperature sensor in a vented and shielded enclosure that minimizes the solar radiation induced temperature error. The console houses the inside temperature sensor. Additional temperature sensors are available for wireless stations and can be used to measure up to eight locations.

Apparent Temperatures

Vantage Pro2 calculates three apparent temperature readings: Wind Chill, Heat Index, and the Temperature/Humidity/Sun/Wind (THSW) Index. Apparent temperatures use additional weather data to calculate what a human body perceives the temperature to be in those conditions.

Wind chill

Wind chill takes into account how the speed of the wind affects our perception of the air temperature. Our bodies warm the surrounding air molecules by transferring heat from the skin. If there’s no air movement, this insulating layer of warm air molecules stays next to the body and offers some protection from cooler air molecules. However, wind sweeps that comfy warm air surrounding the body away. The faster the wind blows, the faster heat is carried away and the colder you feel.

Heat Index

The Heat Index uses temperature and the relative humidity to determine how hot the air actually “feels.” When humidity is low, the apparent temperature will be lower than the air temperature, since perspiration evaporates rapidly to cool the body. However, when humidity is high (*i.e.*, the air is more saturated with water vapor) the apparent temperature “feels” higher than the actual air temperature, because perspiration evaporates more slowly.

Note: Vantage Pro2 measures Heat Index only when the air temperature is above 57° F (14° C), because it's insignificant at lower temperatures. (Below 57°, Heat Index = the air temperature.) The Heat Index is not calculated above 135° F (52° C).

Temperature/Humidity/Sun/Wind (THSW) Index

The THSW Index uses humidity and temperature like the Heat Index, but also includes the heating effects of sunshine and the cooling effects of wind (like wind chill) to calculate an apparent temperature of what it “feels” like out in the sun. The THSW Index requires a solar radiation sensor.

Humidity

Humidity itself simply refers to the amount of water vapor in the air. However, the amount of water vapor that the air can contain varies with air temperature and pressure. Relative humidity takes into account these factors and offers a humidity reading which reflects the amount of water vapor in the air as a percentage of the amount the air is capable of holding. Relative humidity, therefore, is not actually a measure of the amount of water vapor in the air, but a ratio of the air's water vapor content to its capacity. When we use the term humidity in the manual and on the screen, we mean relative humidity.

It is important to realize that relative humidity changes with temperature, pressure, and water vapor content. A parcel of air with a capacity for 10 g of water vapor which contains 4 g of water vapor, the relative humidity would be 40%. Adding 2 g more water vapor (for a total of 6 g) would change the humidity to 60%. If that same parcel of air is then warmed so that it has a capacity for 20 g of water vapor, the relative humidity drops to 30% even though water vapor content does not change.

Relative humidity is an important factor in determining the amount of evaporation from plants and wet surfaces since warm air with low humidity has a large capacity to absorb extra water vapor.

Dew Point

Dew point is the temperature to which air must be cooled for saturation (100% relative humidity) to occur, providing there is no change in water vapor content. The dew point is an important measurement used to predict the formation of dew, frost, and fog. If dew point and temperature are close together in the late afternoon when the air begins to turn colder, fog is likely during the night. Dew point is also a good indicator of the air's actual water vapor content, unlike relative humidity, which takes the air's temperature into account. High dew point indicates high water vapor content; low dew point indicates low water vapor content. In addition a high dew point indicates a better chance of rain, severe thunderstorms, and tornados.

You can also use dew point to predict the minimum overnight temperature. Provided no new fronts are expected overnight and the afternoon Relative Humidity is greater than or equal to 50%, the afternoon's dew point gives you an idea of what minimum temperature to expect overnight, since the air can never get colder than the dew point.

Rain

Vantage Pro2 incorporates a tipping-bucket rain collector in the ISS that measures 0.01" for each tip of the bucket. A metric adapter can be installed to measure 0.2 mm for each tip of the bucket. Your station logs rain data in the same units it is measured in and converts the logged totals into the selected display units (inches or millimeters) at the time it is displayed. Converting at display time reduces possible compounded rounding errors over time.

Four separate variables track rain totals: "rain storm", "daily rain", "monthly rain", and "yearly rain". Rain rate calculations are based on the interval of time between each bucket tip, which is each 0.01" rainfall increment or .2 mm.

Barometric Pressure

The weight of the air that makes up our atmosphere exerts a pressure on the surface of the earth. This pressure is known as atmospheric pressure. Generally, the more air above an area, the higher the atmospheric pressure, this, in turn, means that atmospheric pressure changes with altitude. For example, atmospheric pressure is greater at sea-level than on a mountain-top. To compensate for this difference and facilitate comparison between locations with different altitudes, atmospheric pressure is generally adjusted to the equivalent sea-level pressure. This adjusted pressure is known as barometric pressure. In reality, the Vantage Pro2 measures atmospheric pressure. When you enter your location's altitude in Setup Mode, the Vantage Pro2 stores the necessary offset value to consistently translate atmospheric pressure into barometric pressure.

Barometric pressure also changes with local weather conditions, making barometric pressure an extremely important and useful weather forecasting tool. High pressure zones are generally associated with fair weather while low pressure zones are generally associated with poor weather. For forecasting purposes, however, the absolute barometric pressure value is generally less important than the change in barometric pressure. In general, rising pressure indicates improving weather conditions while falling pressure indicates deteriorating weather conditions.

Solar Radiation

What we call "current solar radiation" is technically known as Global Solar Radiation, a measure of the intensity of the sun's radiation reaching a horizontal surface. This irradiance includes both the direct component

from the sun and the reflected component from the rest of the sky. The solar radiation reading gives a measure of the amount of solar radiation hitting the solar radiation sensor at any given time, expressed in Watts/sq. meter (W/m^2). Solar radiation requires the solar radiation sensor.

UV (Ultra Violet) Radiation

Energy from the sun reaches the earth as visible, infrared, and ultraviolet (UV) rays. Exposure to UV rays can cause numerous health problems, such as sunburn, skin cancer, skin aging, cataracts, and can suppress the immune system. The Vantage Pro2 helps analyze the changing levels of UV radiation and can advise of situations where exposure is particularly unacceptable. UV radiation requires the UV radiation sensor. The Vantage Pro2 displays UV readings in two scales: MEDs and UV Index.

Note: Your station's UV readings do not take into account UV reflected off snow, sand, or water, which can significantly increase your exposure. Nor do your UV readings take into account the dangers of prolonged UV exposure. The readings do not suggest that any amount of exposure is safe or healthful. Do not use the Vantage Pro2 to determine the amount of UV radiation to which you expose yourself. Scientific evidence suggests that UV exposure should be avoided and that even low UV doses can be harmful.

UV MEDs

MED (Minimum Erythral Dose) is defined as the amount of sunlight exposure necessary to induce a barely perceptible redness of the skin within 24 hours after sun exposure. In other words, exposure to 1 MED will result in a reddening of the skin. Because different skin types burn at different rates, 1 MED for persons with very dark skin is different from 1 MED for persons with very light skin.

Both the U.S. Environmental Protection Agency (EPA) and Environment Canada have developed skin type categories correlating characteristics of skin with rates of sunburn.

TABLE A-1: EPA SKIN PHOTOTYPES

Skin Phototype	Skin color	Tanning & Sunburn history
1 - Never tans, always burns	Pale or milky white; alabaster	Develops red sunburn; painful swelling, skin peels
2 - Sometimes tans, usually burns	Very light brown; sometimes freckles	Usually burns, pinkish or red coloring appears; can gradually develop light brown tan
3 - Usually tans, sometimes burns	Light tan; brown, or olive; distinctly pigmented	Rarely burns; shows moderately rapid tanning response
4 - Always tans; rarely burns	Brown, dark brown, or black	Rarely burns; shows very rapid tanning response

Table A-2: ENVIRONMENT CANADA SKIN TYPES AND REACTION TO THE SUN^a

Skin Type	Skin Color	History of Tanning & Sunburning
I	White	Always burns easily, never tans
II	White	Always burns easily, tans minimally
III	Light Brown	Burns moderately, tans gradually
IV	Moderate Brown	Burns minimally, tans well
V	Dark Brown	Burns rarely, tans profusely
VI	Black	Never burns, deep pigmentation

a. Developed by T. B. Fitzpatrick of the Harvard Medical School. More about the Fitzpatrick Skin Types is available in: Fitzpatrick TB. Editorial: the validity and practicality of sun-reactive skin types I through VI. Arch Dermatol 1988; 124:869-871

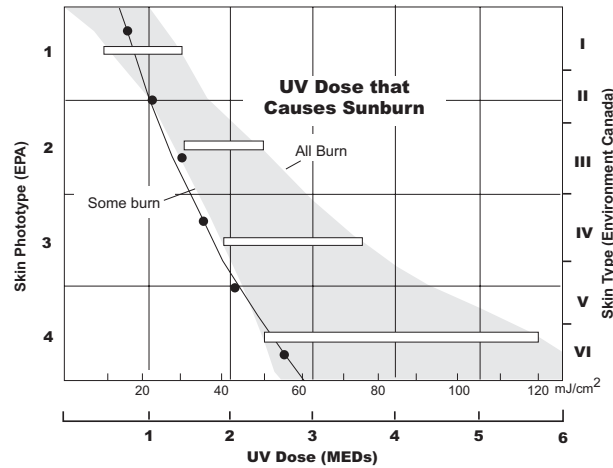

UV Dose and Sunburn - Use this plot to estimate the MED dose leading to sunburn. A person with Type II (Environment Canada) skin type might choose 0.75 MED as the maximum for the day; in contrast, a person with Type V (Environment Canada) Skin Type might consider 2.5 MEDs a reasonable dose for the day. NOTE: the Vantage Pro2 assumes a Fitzpatrick (Environment Canada) Skin Type of II.

UV Index

Vantage Pro2 can also display UV Index, an intensity measurement first defined by Environment Canada and since been adopted by the World Meteorological Organization. UV Index assigns a number between 0 and 16 to the current UV intensity. The US EPA categorizes the Index values as shown in table A-3. The lower the number, the lower the danger of sunburn. The Index value published by the U.S. National Weather Service is a forecast of the next day's noontime UV intensity. The Index values displayed by the Vantage Pro2 are real-time measurements.

TABLE A-3: UV INDEX

Index Values	Exposure Category
0 - 2	Low
3 - 4	Moderate
5 - 6	High
7 - 9	Very High
10+	Extreme

Evapotranspiration (ET)

Evapotranspiration (ET) is a measurement of the amount of water vapor returned to the air in a given area. It combines the amount of water vapor returned through evaporation (from wet vegetation surfaces and the stoma of leaves) with the amount of water vapor returned through transpiration (exhaling of moisture through plant skin) to arrive at a total. Effectively, ET is the opposite of rainfall, and it is expressed in the same units of measure (Inches, millimeters).

The Vantage Pro2 uses air temperature, relative humidity, average wind speed, and solar radiation data to estimate ET, which is calculated once an hour on the hour. ET requires the optional solar radiation sensor.

Leaf Wetness

Leaf wetness (see “Optional Sensors” on page 2) provides an indication of whether the surface of foliage in the area is wet or dry by indicating how wet the surface of the sensor is. The leaf wetness reading ranges from 0 (dry) to 15. Leaf wetness requires an optional Leaf & Soil Moisture/Temperature Station and is only available for Wireless Vantage Pro2 Stations.

Soil Moisture

Soil Moisture, as the name suggests, is a measure of the moisture content of the soil. Soil moisture is measured on a scale of 0 to 200 centibars, and can help choose times to water crops. The soil moisture sensor measures the vacuum created in the soil by the lack of moisture. A high soil moisture reading indicates dryer soil; a lower soil moisture reading means wetter soil. Soil Moisture requires an optional Leaf & Soil Moisture/Temperature Station or Soil Moisture Station and is only available for Wireless Vantage Pro2 Stations.

Time

A built-in clock and calendar track the time and date. The console automatically adjusts for daylight savings time in North America, Europe and Australia (and allows manual adjustment elsewhere) and for leap years.

Appendix B

Specifications

See complete specifications for your Vantage Pro2 Station at our website:
www.davisnet.com.

Console

Console Operating Temperature +14° to +140°F (-10° to +60°C)
Display Temperature +32° to +140°F (0° to +60°C)
Non-operating Temperature -5° to +158°F (-20° to +70°C)
Console Current Draw Wireless: 0.9 mA average, 30 mA peak, (add 80 mA for display lamps, add 0.125 mA for each transmitter station received by console) at 4 to 6 VDC Cabled: 10 mA (average), 15 mA (peak) (+80 mA for illuminated display) at 4 to 6 VDC
Power Adapter 5 VDC, 900 mA
Battery Backup 3 C-cells
Battery Life (no AC power) Wireless: up to 9 months; (Cabled: 1 month (approximately))
Connectors Modular RJ-11
Housing Material UV-resistant ABS plastic
Console Display Type LCD Transflective
Display Backlight LEDs
Dimensions:	
Console (with antenna) 10.375" x 6.125" x 1.5" (264 mm x 156 mm x 38 mm)
Console (no antenna) 9.625" x 6.125" x 1.5" (244 mm x 156 mm x 38 mm)
Display 5.94" x 3.375" (151 mm x 86 mm)
Weight (with batteries) 1.88 lbs. (.85 kg)

Wireless Communication Specifications

Transmit/Receive Frequency US Models: 902 - 928 MHz Overseas Models: 868.0 - 868.6 MHz
ID Codes Available 8
Output Power 902 - 928 MHz FHSS: FCC-certified low power, less than 8 mW, no license required 868.0 - 868.6 MHz: CE-certified, less than 8 mW, no license required
Range	
Line of Sight up to 1000 feet (120 m)
Through Walls 200 to 400 feet (75 to 150 m)

Console Data Display Specifications

Historical Data	Includes the past 24 values listed unless otherwise noted; all can be cleared and all totals reset.
Daily Data	Includes the earliest time of occurrence of highs and lows; period begins/ends at 12:00 am.
Monthly Data	Period begins/ends at 12:00 am on the first of every month.
Yearly Data	Period begins/ends at 12:00 am on January 1 st unless otherwise noted.
Current Data	Current data appears in the right most column in the console graph and represents the latest value within the last period of the graph; totals can be set or reset.
Graph Time Interval	1 min., 10 min., 15 min., 1 hour, 1 day, 1 month, 1 year (user-selectable, availability depends upon variable selected).
Graph Time Span	24 Intervals + Current Interval (see Graph Intervals to determine time span).
Graph Variable Span (Vertical Scale)	Automatic (varies depending upon data range); Maximum and minimum value in range appear in ticker.
Alarm Indication	Alarms sound for 2 minutes (time alarm is 2 minute) if operating on battery power. Alarm message displays in ticker as long as threshold is met or exceeded. Alarms can be silenced, but not cleared, by pressing DONE.
Update Interval	Varies with sensor - see individual sensor specs. Also varies with transmitter ID code - 1 = shortest, 8 = longest.
Forecast:	
Variables Used	Barometric reading & trend, wind speed & direction, rainfall, temperature, humidity, latitude & longitude, time of year.
Update Interval	1 hour
Display Format	Icons on top center of display; detailed message in ticker at bottom.
Variables Predicted	Sky condition, precipitation, Temperature Changes, Wind Direction and Speed Changes.

Weather Data Specifications

Note: These specifications include optional sensors that may not be installed in your Vantage Pro2 Station.

Weather Data Specifications

Variable	Required Sensors	Resolution	Range	Nominal Accuracy (+/-)
Barometric Pressure [*]	Included in Console	0.01" Hg; 0.1 mm; 0.1 hPa; 0.1 mb	26" to 32" Hg; 660 to 810 mm; 880 to 1080 hPa; 880 to 1080 mb ^{**}	0.03" Hg; 0.8 mm Hg; 1.0 hPa; 1.0 mb
Barometric Trend (3 hour)		Change Rates Rapidly: $\geq .06"$ H; 1.5 mm Hg; 2 hPa; 2 mb Slowly: $\geq .02"$ H; 0.5 mm Hg; 0.7 hPa; 0.7 mb	5 Arrow Positions: Rising Rapidly Rising Slowly Steady Falling Slowly Falling Rapidly	
Evapotranspiration (ET)	ISS or Temp/Hum Station & Solar Radiation sensor	0.01"; 0.25 mm	Daily to 99.99"; 999.9 mm Monthly & Yearly to 199.99"; 1999.9mm	greater of 5% or 0.01"; 0.25 mm
Inside Humidity	Included in Console	1%	10 to 90%	5% RH
Outside Humidity	ISS or Temp/Hum Station	1%	0 to 100%	3% RH; 4% above 90%
Extra Humidity	ISS or Temp/Hum Station	1%	0 to 100%	3% RH; 4% above 90%
Dew Point (overall)	ISS or Temp/Hum Station	1°F; 1°C	-105° to +130°F; -76° to +54°C	3°F; 1.5°C
Leaf Wetness	Leaf & Soil Station	1	0 to 15	0.5
Soil Moisture	Leaf & Soil Station or Soil Moisture Station	1 cb	0 to 200 cb	
Daily & Storm Rainfall	Rain Collector	0.01"; 0.25mm	to 99.99"; 999.9 mm	greater of 4% or 1 tip,
Monthly & Yearly Rainfall		0.01"; 0.25mm (1mm at totals over 2000 mm)	to 199.99"; 19,999 mm	greater of 4% or 1 tip
Rain Rate		0.01"; 0.25 mm	to 100"/hr; 1999.9 mm/hr	greater of 5% or 0.04"/hr; 1 mm/hr

^{*} Barometric pressure readings are standardized to sea level. Elevation Range: -1500' to +12,500'; -460 to + 3810 m. Note: The console screen limits display of lower elevation to -999' when using feet as elevation unit.

^{**} This is the reduced value after standardizing to sea level.

Weather Data Specifications

Weather Data Specifications

Variable	Required Sensors	Resolution	Range	Nominal Accuracy (+/-)
Solar Radiation	Solar sensor	1 W/m ²	0 to 1800 W/m ²	5% of full scale
Inside Temperature	Included in Console	0.1°F; 0.1°C	+32° to +140°F; 0 to +60°C	1°F; 0.5°C
Outside Temperature ***	ISS, Temp Station or Temp Hum Station	0.1°F; 0.1°C	-40° to +150°F; -40° to +65°C	1°F; 0.5°C
Extra Temperature	ISS, Temp Station, Temp Hum Station, Leaf Soil Station or Soil Station	1°F; 1°C	-40° to +150°F -40° to +65°C	1°F (0.5°C)
Heat Index	ISS or Temp/Hum Station	1°F; 1°C	-40° to +135°F; -40° to +57° C	3°F (1.5°C)
Temp-Hum-Sun-Wind index (THSW)	ISS & Solar Radiation	1°F; 1°C	-90° to +135°F; -68° to +64° C	4°F (2°C)
Time	Included in Console	1 min	24 hours	8 sec/mon
Date		1 day	month/day	8 sec/mon
UV Index	UV Radiation	0.1 Index	0 to 16	5% of full scale
UV Dose		0.1 MED < 20, 1 MED > 20	0 to 199 MEDs	5%
Wind Direction	Anemometer	1°	0 to 360°	7°
Compass Rose		22.5°	16 compass pts	0.3 compass pt
Wind Speed (large cups)		1 mph; 1 kt; 0.5 m/s; 1 km/h	2 to 150 mph; 2 to 130 kts 3 to 241 km/h, 1 to 68 m/s	greater of 2 mph/kts; 1 m/s; 3 km/h or 5%
Wind Speed (small cups)		1 mph; 1 kt; 0.5 m/s; 1 km/h	3 to 175 mph; 3 to 150 kts 1.5 to 79 m/s 5 to 282 km/h	greater of 3mph; 3 kts; 1 m/s; 5km/h or 5%
Wind Chill	ISS	1°F; 1°C	-120° to +130°F -84° to +54°C	2°F; 1°C

***Outside temperature accuracy is based on the temperature sensor itself and not on the sensor and the passive shielding together. The solar radiation induced error for standard ration shield: +4°F (2°C) at solar noon; for fan aspirated radiation shield: +0.6°F (0.3°C) at solar noon (insolation = 1040 W/m², avg. wind speed ≤ 2 mph (1 m/s), reference: RM Young Model 43408 Fan-Aspirated Radiation Shield).

Vantage Pro2 Console Icons

Console icons indicate weather conditions and special functions.

Forecast

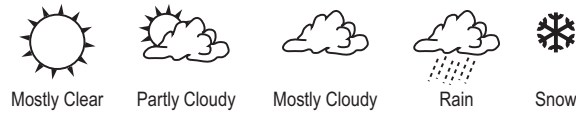

Indicates the weather forecast for the next 12 hours.

Moon Phase



Shows the current moon phase. Sequence shown for Northern Hemisphere. Reverse sequence for the Southern Hemisphere.

Alarm Bell

Flashes when an alarm is triggered. Also indicates when the console is in Alarm Mode.



Graph

Appears next to the currently selected weather variable. Also indicates the graphed variable on most screens.



Second Function

Appears when you press 2ND key. Indicates that console key secondary functions are enabled.



Rain

Appears when the console is currently detecting rain.



Barometric Pressure Trend

Arrows show direction of pressure change for last three hours.



Contacting Davis Technical Support

If you have any questions, or encounter problems installing or operating your Vantage Pro 2 weather station, please contact Davis Technical Support. We'll be glad to help.

(510) 732-7814 — Monday - Friday, 7:00 a.m. - 5:30 p.m. Pacific Time. We are unable to accept collect calls.

(510) 670-0589 — Technical Support Fax.

support@davisnet.com — E-mail to Technical Support.

info@davisnet.com — General e-mail.

www.davisnet.com — Davis Instruments web site.

See the Weather Support section for copies of user manuals, product specifications, application notes, and information on software updates. Watch for FAQs and other updates.

Free Manuals Download Website

<http://myh66.com>

<http://usermanuals.us>

<http://www.somanuals.com>

<http://www.4manuals.cc>

<http://www.manual-lib.com>

<http://www.404manual.com>

<http://www.luxmanual.com>

<http://aubethermostatmanual.com>

Golf course search by state

<http://golfingnear.com>

Email search by domain

<http://emailbydomain.com>

Auto manuals search

<http://auto.somanuals.com>

TV manuals search

<http://tv.somanuals.com>