



**ACP09H1
ACP12H1**

You can rely on Defy. To simplify.

INSTRUCTION MANUAL

PORTABLE AIR CONDITIONERS

Record in the space below the listed information for future reference.

SERIAL NUMBER.....

DATE OF PURCHASE.....

PURCHASED FROM.....

.....



Do not attempt to maintain the appliance yourself. Only authorised agents are to carry out repairs.



Read this manual before initial installation and operation of the appliance!

Dear Customer, Your new Defy appliance was manufactured in a state of the art facility and has passed the strictest quality control procedures. Please read this manual carefully before using your appliance for the first time and then store it within easy reach for future reference. We trust you will enjoy years of trouble free use.

The user manual:

- This manual will provide you with information on how to safely operate and care for your appliance in order that you gain the maximum benefit from it.
- Pay particular attention to safety instructions.
- Read all additional documents supplied with your appliance.
- This manual may be used for several similar but different models. Please check for relevance regarding your particular model.

Explanation of symbols used in this manual



Important safety information. Warning for hazardous situations with regard to life and property.



Caution; Warning for supply voltage.



Caution; Warning for fire hazard.



Read the instructions.



Useful information. Important information or useful hints about usage.

Unpacking





Remove all packaging. Ensure that packing material is disposed of in a responsible manner and that any plastic bags are cut up to prevent children playing with them and accidentally suffocating. If the appliance is damaged in any way do not use it. Report the damage to your dealer who will take the necessary corrective action.

Contents

<u>1. Specifications</u>	<u>3</u>	<u>5. Control panel</u>	<u>9</u>
<u>2. Important Safety Information</u>	<u>4</u>	Remote control	9
Warnings	4	Operating modes	10
<u>3. Your air conditioner</u>	<u>6</u>	Water drainage	11
<u>4. Placement</u>	<u>7</u>	<u>6. Maintenance and cleaning</u>	<u>12</u>
Installation	7	<u>7. Trouble shooting</u>	<u>13</u>
Installation errors	8	<u>8. Service Centres</u>	<u>15</u>
		<u>9. Warranty</u>	<u>16</u>

1 Specifications

Model		ACP09H1	ACP12H1
Cooling capacity (Btu/h)		9000	12000
Cooling capacity (W/h)		2610	3520
Heating capacity (Btu/h)		8050	11000
Heating capacity (W/h)		2700	3500
Energy rating-Cooling		A	A
Energy rating-Heating		C	C
Air Flow volume (m3/h)		380	450
Power Supply (V/Hz)		220-240V/50	220-240V/50
Rated input Power (W)	Cooling	990	1340
	Heating	870	1320
Rated input Current (A)	Cooling	4.20	5.90
	Heating	4.00	5.60
Refrigerant		R410A	R410A
Dimensions (WxHxD) mm		320 x 730 x 370	460 x 846 x 420
Net weight (Kg)		21.5	32.5
Noise (dB)		56	56
Climate class		T1	T1
Electric safety class		I	I















	This appliance is not intended for use by persons (including children) with reduced physical, sensory or mental capabilities or lack of experience and knowledge, unless they have been given supervision or instruction concerning the use of the appliance by a person responsible for their safety.
	Children should be supervised to ensure that they do not play with the appliance.
	The manufacturer strives for continuous improvement. Thus technical specifications, text and illustrations in this manual are subject to change without notice.
	Figures represented in this instruction manual are schematic and may not correspond exactly with your appliance. If the parts are not included in the appliance you have purchased, they may be model specific and only valid for some models.
	Values stated on the labels or in the documentation accompanying it are obtained in laboratory conditions in accordance with the relevant standards. Depending on operational and environmental conditions of the unit, these values may vary.

















2 Important safety information

Please review and observe the following information. Failure to do so may result in injuries or material damage and will render any warranty and reliability commitments void.

Warnings

- Hand this owners manual over to the new owner should ownership change.
- The appliance must only be used for its intended purpose: Room temperature regulation.
- The appliance is intended for domestic use only.
- Consult with your authorised DEFY service centre for all questions and problems relating to the appliance. Only authorised agents are to carry out repairs.

	Place the appliance in a dry environment. Do not spatter water or oil into the appliance. Use indoors only. Do not use outdoors.
	Do not unplug the power cord during operation. Doing so could cause a fire. To unplug the appliance, switch off the unit and remove the plug by pulling on the plug and not the cord!
	Do not attempt to extend the power cord by joining it to another cord, or by using an extension cord. Do not put any other loads on the power supply socket. Extension cables and multiway plugs must not be used for connection.
	Do not damage the power cord. Placing heavy objects on the power cord, having the power cord near objects that operate at high temperatures may cause electric shock and fire.
	Unplug the power plug or switch off the power supply when not using the appliance for a long time. (Accumulated dirt might cause fire).
	Ensure the supply voltage meet the requirements as per the specification table. Damages caused by incompatible connections are not covered by the warranty
	An earth leakage breaker with rated capacity must be installed to avoid possible electric shocks.
	Do not place burner type appliances where they will be exposed to the airflow of the air conditioner as this may cause incomplete combustion.
	Do not use the following for cleaning: Chemical solvents, insecticide or inflammable spraying materials. These will damage the appearance of the appliance. Do not spray or sprinkle water directly onto the appliance.
	Vapour and vaporized cleaning materials must never be used in cleaning the appliance. The vapour may come into contact with the electrical parts and cause a short circuit or electric shock.
	Close doors and windows while operating the appliance for a long time, if room air is quite turbid, open the door and window for a short period of time to allow for some fresh air circulation.
	If anything abnormal such as a burning smell occurs, stop the operation immediately and unplug the appliance.
	Do not place the appliance at locations where flammable gas may leak. If there is an electrical leakage from the appliance, it may cause a fire or explosion.
	Do not use the appliance other than for its intended purpose. Do not use your appliance for cooling medicine or academic research samples which require strict temperature control.

	Do not insert a finger, a rod or any other objects into the air outlet/inlet grille. The fan runs at a high speed and it will cause an injury if touched.
	Do not dispose of the appliance along with regular household waste. Contact your local authority for disposal information and facilities available. Never dispose of the appliance in a fire.
	Do not allow children to climb on the appliance. Never use the parts of your appliance as a means of a support or step.
	Young children or infirm persons are not to use the appliance without supervision.
	Keep ventilation openings clear of obstructions.
	Unplug the appliance when cleaning, during routine maintenance or if it will not be used for an extended period of time.
	Should the mains lead of the appliance become damaged or should it need replacing at any time, it must be replaced by a special purpose made mains lead which can only be obtained from a DEFY Authorised Service Agent.
	Never connect the appliance to electricity saving systems, these may cause damage. Do not pull the batteries of the remote apart or throw them in a fire, they will explode.
	Do not use explosive substances such as aerosol cans with a flammable propellant near the appliance. Do not use flammable gas, benzene, petrol or volatile substances near the appliance.
	In the event of a malfunction, disconnect the appliance from the power supply. Do not operate a damaged appliance. Consult with your nearest DEFY service centre should you have any concerns.
	Never place objects on top of the appliance.
	Keep the appliance away from heat sources and out of direct sunlight.
	The electrical safety of the appliance is only guaranteed if the earth system of your home is compliant with national standards.
	Do not expose your body directly to the cool (or hot) air of the appliance for prolonged periods; do not cool (or heat) the room too much. This could effect your physical condition and cause health problems.
	Do not leave the appliance to run when there is no one around. If you are going to be away even for a short period, turn the appliance off.
	The appliance must NOT be installed in the laundry. The appliance must be positioned so that the plug is accessible. Keep the appliance in the upright position, having it in any other position will compromise the compressor performance. Ensure the wall socket can be easily reached from the appliance location. Keep the appliance on flat level ground with a clearance of at least 50 cm from any objects. Ensure that the air inlet and air outlet are not obstructed. Ensure there is no damage to the plug. To run the appliance, first insert the plug into wall socket, switch on at the wall outlet and then press the "Power" button.

3 Your Air Conditioner

ACP09H1

1. Handle
2. Control panel
3. Air outlet
4. Fan blade
5. Castor
6. Upper filter frame
7. Exhaust connector
8. Lower filter frame
9. Rubber plug
10. Plug cap
11. Power cord

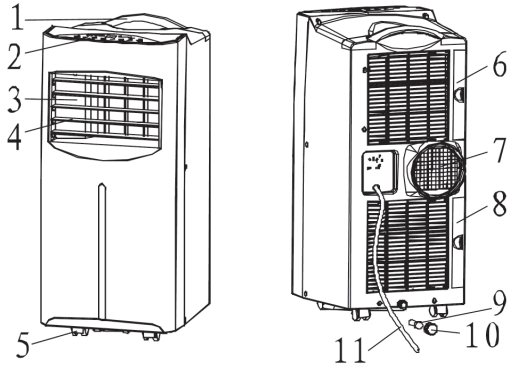

ACP12H1

1. Control panel
2. Air outlet
3. Button
4. Handle
5. Castor
6. Upper filter frame
7. Exhaust connector
8. Lower filter frame
9. Rubber plug
10. Plug cap
11. Power cord

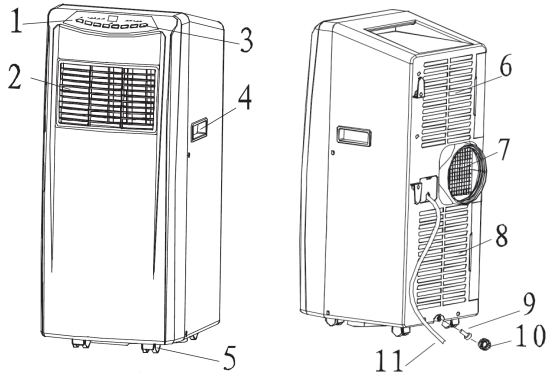

Accessories ACP09H1

Check the accessories
of the appliance.



Remote control

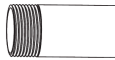

Exhaust hose

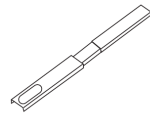

Ajustable slide bar

Read the user manual
before using the
accessories.



Slide bar connector

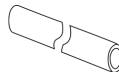

Drain pipe (ID: 10mm)
(only for heating model)



Drain connector
(only for heating model)

Accessories ACP12H1



Remote control



Exhaust hose



Ajustable slide bar



Slide bar connector

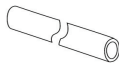

Drain pipe (ID: 10mm)
(only for heating model)



Drain connector
(only for heating model)

4 Placement

Place the appliance on a flat dry area, and keep it at least 50cm away from other objects. (Fig.1).

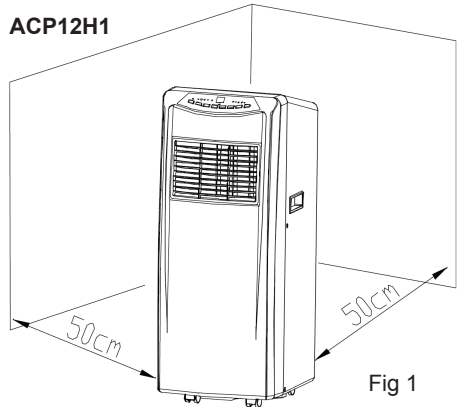
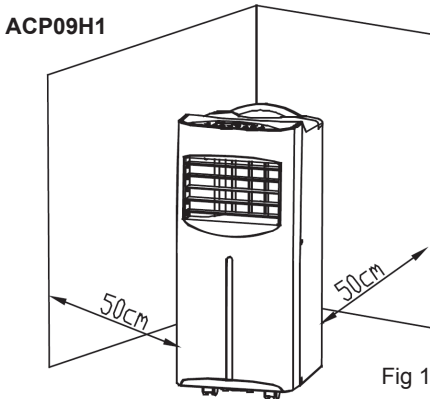

Installation

First twist the slide bar connector onto the exhaust hose, then twist the exhaust hose into the exhaust connector (counter-clockwise) (Fig. 2). Place the slide bar connector into the adjustable slide bar, adjust the window aperture in order to suit the slide bar. Adjust the width of the slide bar to suite the window. (Fig.3).

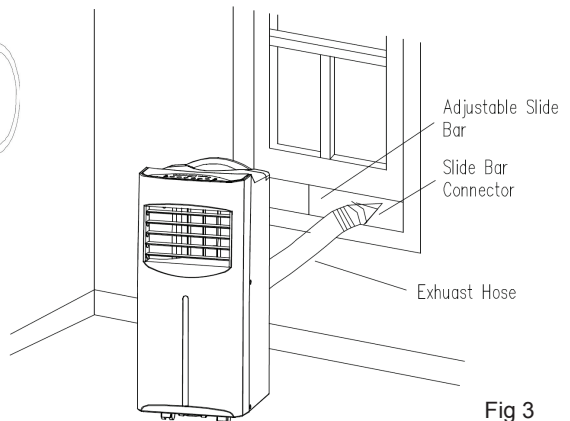
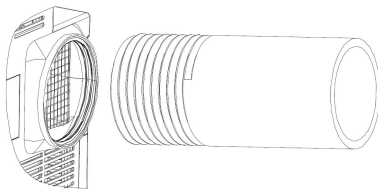

The manufacturer strives for continuous improvement. For this reason, the text and illustrations in this manual are subject to change without notice.



Figures represented in this instruction manual are schematic and may not correspond exactly with your appliance. If the parts are not included in the unit you have purchased, they may be model specific and only valid for some models.

Installation errors

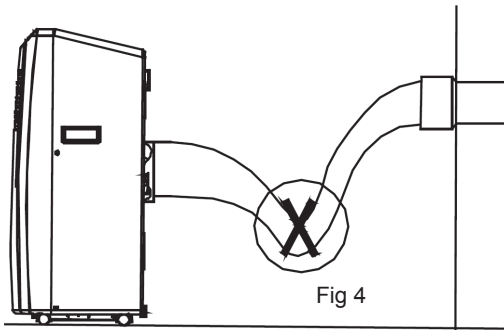

The free, unobstructed flow of the exhaust pipe is important, a bad installation will adversely affect the performance of the appliance.

Avoid having sharp bends in the exhaust-pipe. (Fig.4)

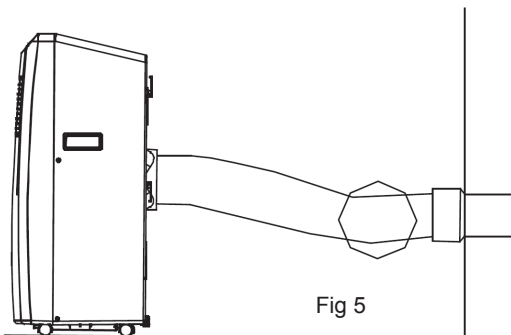

Make sure that the air in the exhaust pipe is not obstructed from flowing freely. (Fig.5).



	Warning: The length of the exhaust pipe has been calculated to suit the appliance, do not replace or lengthen the exhaust pipe as this will adversely affect the performance of the appliance.
	Note: The maximum length of the exhaust pipe is 1500mm. Keep the length as short as possible. Keep the exhaust pipe as level as possible so as not to restrict air flow.
	Note: Handle the exhaust pipe with care! Do not damage the exhaust pipe or drain pipe. Any damage to the exhaust pipe or drain pipe is not covered by the warranty. Spare exhaust pipes and drain pipes can be purchased from your nearest Defy spares outlet.

5 Control panel

ACP09H1

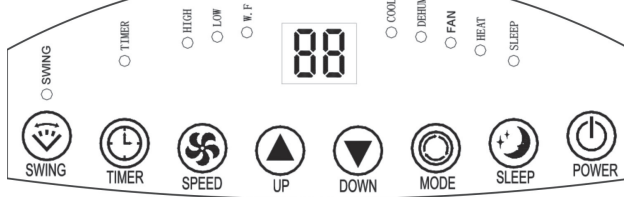

ACP12H1

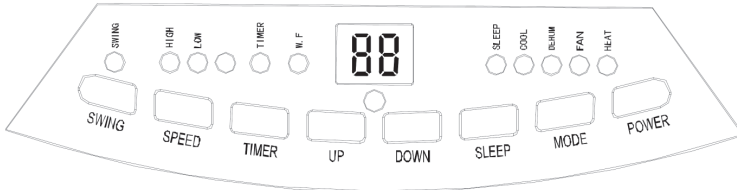

1. **POWER:** Press this button to switch the appliance on/off. When the appliance is on, the default setting will be cooling mode with a low fan speed.
2. **MODE:** When the appliance is on, press this button to select cooling, dehumidifying, fan and heating modes.
3. **SPEED:** When the appliance is on, press this button to select fan speed (high and low).
4. **DOWN:** In cooling or heating mode, press this button to decrease the temperature from between 16~31°C.
5. **UP:** In cooling or heating mode, press this button to increase the temperature from between 16~31°C.
6. **SLEEP:** In cooling or heating mode, press this button to switch on/off the sleep function.
7. **TIMER:** In power-on or standby mode, press this button to setup the on/off time from 1~24.
8. **SWING (Air flow):** After machine is switched on, press this button, the louver will swing continuously left to right; by pressing the swing button again the movement will stop and the louver remains in its present position.

Remote control

1. Power
2. Timer
3. Down
4. Mode
5. Up
6. Fan
7. Sleeping
8. Swing

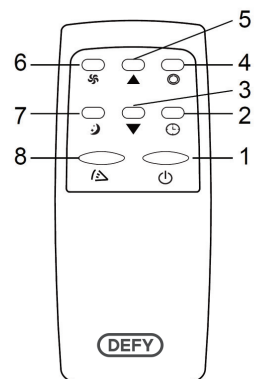

Operating modes

Cooling mode

When the appliance is on, the default setting is cooling mode with 22°C and a low fan speed.
Press “MODE” to select cooling mode: the cooling mode indicator switches on.
Press “UP” or “DOWN” to adjust the temperature (from 16°C to 31°C).
Press “SPEED” to select high or low fan speed.

Heating mode (Optional)

Press “MODE” to select heating mode: the heating mode indicator switches on.
Press “UP” or “DOWN” to adjust the temperature (from 16°C to 31°C).
Press “SPEED” to select high or low fan speed.

Note: To prevent having to empty the water-tank under heating mode, connect a water drainage pipe to allow the water to continuously drain.

Fan mode

Press “MODE” to select fan mode: fan mode indicator switches on.
Press “SPEED” to select high speed or low speed.
Temperature and sleep function cannot be set in this mode.

Timer mode

Under standby mode, press “TIMER” to setup the power-on time. Timer indicator switches on.
Under power-on mode, press “TIMER” to setup power-off timer. Timer indicator switches on.

Dehumidifying mode

Press “MODE” to select dehumidifying mode, the dehumidifying mode indicator switches on.
Under dehumidifying mode, sleep function cannot be set, and fan speed is low.

Sleep mode

Press “SLEEP” to enter into sleep mode, the default value of the fan speed is low.
When sleep mode is switched on, under cooling mode, after 1 hour has elapsed the set temperature will go up by 1°C. After the next hour has elapsed, the set temperature will go up by another 1°C, and then remain at this temperature ; under heating mode, after 1 hour has elapsed the set temperature will go down by 1°C, After the next hour has elapsed, the set temperature will go down by another 1°C, and then remain at this temperature .
Sleep mode does not operate under the dehumidifying mode and the fan mode. When the water is full or the machine is on standby or when under mode conversion, sleep mode will be non functional.

Compressor protection

Three minutes after power on / restart, the compressor will start to run.

Water drainage

This appliance has an auto-water-evaporating system. It has a condensed-water cycle to cool down the condenser. This improves cooling efficiency and saves energy.

If the inner water tank is full, the "WF" (Water full) indicator will flash on the display, the appliance will enter into standby mode and the buzzer will emit a sound. The compressor will stop and all buttons will be non operational until the water has been drained. To drain the water, remove the rubber plug and allow the water to drain. When the water has drained, power off the appliance and restart it. The appliance will then run normally.

For heating mode:

Note: To prevent having to empty the water-tank under heating mode, connect a water drainage pipe to allow the water to continuously drain.

1. Remove the drain knob.
2. Remove the rubber plug and keep it in a safe place for future use.
3. Fix the drain connector into the drain knob.
4. Fix the drain knob to the water-outlet of the unit.
5. Connect one end of the drain pipe (ID:10mm) into the water outlet as per the following diagrams and place the outlet end into a water-container.

Note: The water-container must be level with or lower than the outlet level.

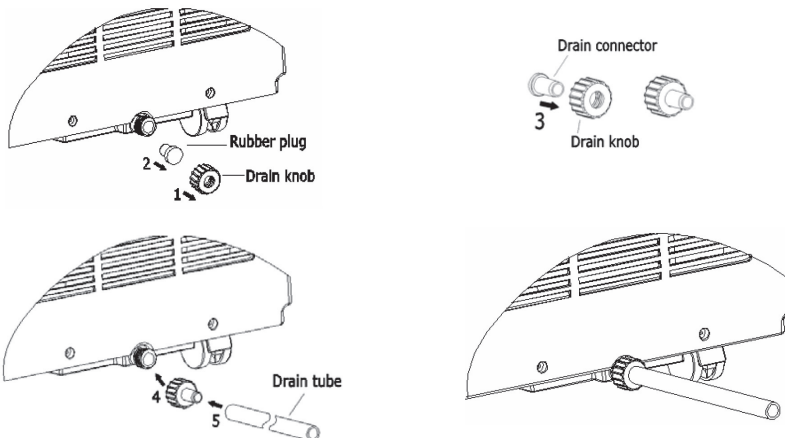

6 Maintenance and cleaning



Warning: In order to avoid an electric shock, always power off the appliance and pull out the plug from the wall socket before cleaning, maintenance or repairs.



Warning: Do not attempt to maintain or repair the appliance yourself. Only authorised agents are to carry out repairs.

Cleaning the appliance

1. Wipe the surface of the appliance with a soft moist cloth and then wipe it again with a soft dry cloth. (Do not use benzene, solvent or any other chemical products).
2. Don't spatter water into the appliance.

Cleaning the air filters

1. Clean the air filters at least once in every two weeks. Before cleaning, be sure to stop the operation of the appliance and pull out the plug from the wall socket.
2. If the filters are blocked and are not cleaned then the efficiency of the air conditioner will be reduced.
3. Remove the filters as indicated in the diagram. Wash the filters in clean water and leave them to dry in the shade.
4. Refit the filters.

Note: Do not run the appliance without filters.

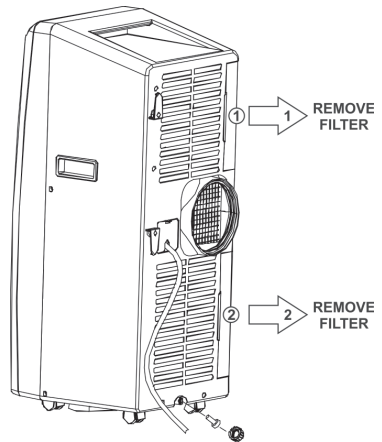

If you will not be using the appliance for a long period of time

- Pull out the drainage plug and allow all the water to drain.
- Run the appliance under fan mode for 2 hours in order to thoroughly dry out the inside of the appliance.
- Switch off the appliance and unplug it from the wall socket.
- Clean and dry filters, then reinstall them.
- Clean the outer surfaces of the appliance.
- Remove the exhaust pipe and keep it in a safe place.
- Cover the appliance with a plastic bag, and store it in a dry area.
- Take out the batteries from the remote controller.

If you have not used the air conditioner for a long period of time

1. Clean the filters and refit them to their original position. Clean the appliance with a piece of soft cloth.
2. Insert the power plug (ensure the earth wire is not loose).
3. Refit the batteries into the remote controller.

7 Trouble shooting

Please review this list before calling a service centre. It could save you time and money. This list includes frequent complaints that do not arise from defective workmanship or material usage. Some of the features described here may not apply to your model.

Symptom	Check
The air conditioner does not operate.	<ul style="list-style-type: none">• Make sure the air conditioner plug is securely plugged in.• Are there any obstacles or disturbance supply oscillators in the room that may be disturbing the signal from the remote controller?• Is there a power failure?• Is the power plug plugged into the wall socket properly?• Check for a blown fuse or tripped circuit breaker.• Test the wall socket for power using another appliance.• Inspect the electrical cord for damage.• Eliminate the use of an extension cord, if any is being used.• Water full indicator is on. Drain the water.
The remote controller is not operational .	<ul style="list-style-type: none">• Check whether the batteries of the remote controller are usable.• Check whether the batteries are positioned correctly.
Air conditioner restarts frequently.	<ul style="list-style-type: none">• Direct sunlight is on the air conditioner. Draw the curtains.• Door and windows are open. Close the door and windows.• Heat sources in the room. Move out or switch off heat sources.• Air inlet or air outlet is blocked. Remove the blockage.
Air conditioner is noisy.	<ul style="list-style-type: none">• Air conditioner has not been placed on level ground. Place on level, solid ground.
Cooling and heating effect is not good.	<ul style="list-style-type: none">• Is the temperature setting appropriate?• Are the air filters clean?• Are there any obstacles blocking the air inlet and air outlet?• Are doors and windows closed?
Compressor does not work.	<ul style="list-style-type: none">• Compressor time delay protection is on. Wait for 3 minutes, then restart the air conditioner after the temperature drops.



If an abnormal operating condition occurs, switch off the air conditioner and unplug the plug from the wall socket. Consult with your authorised DEFY service centre for all questions and problems relating to the air conditioner. Only authorised agents are to carry out repairs.

Since the following are not factory faults they are the owners responsibility:

- Damage to the exterior finish and breakage of components.
- Damage caused through improper use of the appliance.
- Damage caused by moving the appliance.

If you find one of the following symptoms, please switch the circuit breaker off immediately and call the nearest authorised Defy service centre for help.

- The power cord has overheated or is damaged.
- An abnormal sound is heard during operation.
- The circuit breaker, fuse or the earth leakage breaker often cuts off the operation.
- One of the switches or buttons often fails to work normally.
- The air conditioner emits a burning smell during operation.
- Water leaks from the unit.

	Warning: If the supply cord is damaged, it must be replaced by the manufacturer, its service agent or similarly qualified persons in order to avoid a hazard.
	Note: Due to a policy of continuous improvement, we reserve the right to modify technical data without notice. While errors and omissions are a possibility, every reasonable effort has been made to ensure that the information in this manual is correct.

Service Centres

If you have followed the instructions and still have a problem, contact the nearest Defy Service Centre. They will be able to advise you on any aspect of the appliance or send a qualified technician to repair it.

BLOEMFONTEIN

160 Long Street, Hilton, Bloemfontein 9301
Tel: 051 400 3900
Bloemfontein.Service@defy.co.za

CAPE TOWN

5A Marconi Rd. Montague Gardens, 7441
Tel: 021 526 3000
CapeTown.Service@defy.co.za

DURBAN

35 Intersite Avenue, Umgeni Business Park,
Durban, 4051
Tel: 031 268 3300
Durban.Service@defy.co.za

EAST LONDON

16 Bowls Rd. Arcadia, East London, 5201
Tel: 043 743 7100
EastLondon.Service@defy.co.za

JOHANNESBURG

Cnr. Mimetes & Kruger Sts. Denver ext.12
Johannesburg, 2094
Tel: 011 621 0200 or 011 621 0300
Gauteng.Service@defy.co.za

POLOKWANE

87 Nelson Mandela Drive, Superbia 0699
Tel: 0152 92 1166 / 7 / 8 / 9
Polokwane.Service@defy.co.za

PORT ELIZABETH

112 Patterson Road, North End, Port Elizabeth 6001
Tel: 041 401 6400
PortElizabeth.Service@defy.co.za

PRETORIA

Block A1 Old Mutual Industrial Park,
Cnr. D.F.Malan Drive & Moot Str. Hermanstad, 0082
Tel: 012 377 8300
Pretoria.Service@defy.co.za

ZAMBIA: SOUTHGATE INVESTMENTS LTD

Plot 1606, Sheki Sheki Road
P.O. Box 33681
Lusaka, 10101, Zambia
Tel: +260 0211 242332/3
Fax: +260 0211 242933
sqiservicecentre@microlink.zm

NAMIBIA: ATLANTIC DISTRIBUTORS (PTY) LTD

10 Tienie Louw Street, Northern Industrial Area
P.O. Box 21158, Windhoek, Namibia
Tel: (061) 216162
Fax: (061) 216134
atlantic@mweb.com.na

ZIMBABWE: TRADECOMAFRICA

Trade Com Africa, 183 Loreley Crescent
Msasa, Harare, Zimbabwe
Tel: +263 4 486165/6
Cell: +263 772 469010
Cell: +263 772 469011

BOTSWANA: RAY MORGAN AGENCIES

RMA Service Centre, Plot 48, East Gate
Gaborone International Commerce Park
Kgale View, Gaborone
Botswana
Tel: +267 390 3996 / 390 3912
Fax: +267 318 7376
Cell: +267 7134 6539
service@rma.co.bw; raja@rma.co.bw

SWAZILAND: LYNDS DISTRIBUTORS

P.O Box 716, Mbabane, Swaziland, H100
Tel: (00268) 2515 4310/8
Fax: (00268) 2518 4318

MOZAMBIQUE: COOL WORLD. LDA

Rua da Resistencia No. 97B R/C
Cell: +258 84 44 61 234
coolworldlda@hotmail.com
Nosso Show Room
Av: da Industrias, Parcela No.735 * 735A
Machava, Maputo

**OTHER AREAS ARE SERVICED BY OVER 200 AUTHORISED SERVICE AGENTS.
PLEASE CONSULT THE NEAREST REGIONAL DEFY SERVICE CENTRE FOR DETAILS.**

Please register your product at
www.defy.co.za
DEFY APPLIANCES (PTY) LTD
P.O.BOX 12004
JACOBS
DURBAN
4026
SOUTH AFRICA

This certificate is issued by DEFY APPLIANCES (PTY) LIMITED manufacturers of Defy and Ocean products, hereinafter the Company, to the original purchaser only, of the appliance described on the certificate and shall constitute the only warranty given in respect of this appliance.

The Company warrants to the original purchaser that for a period of TWO YEARS from date of purchase the appliance is free from defect under normal domestic use, both in workmanship and material, subject to the following conditions.

1. Repair or replacement of any part of this appliance, found by the Company to be defective, shall be at the election of the Company. The Company reserves the right to effect such service through any of its Service Divisions or Authorised Service Dealers. The cost of such service shall be borne by the Company in full, provided that the appliance is located no further than 50km from a Company Service Centre or an Authorised Service Dealer. Where the appliance is located beyond the 50km radius, the purchaser shall be liable for the standard travelling charges, as determined by the Company.
2. **Carry-in service. Portable Air conditioners are repaired in our service centres and are not collected from the customers home. Faulty units should be delivered to the purchasing dealer or to the nearest Company Service Centre for warranty repairs.**
3. Vitreous enamelware, fuses and lamps are specifically excluded from these warranties. It is an express condition of these warranties that the purchaser takes due care and attention in the use and maintenance of the appliance. Abuse, misuse in conflict with operating instructions, connection to incorrect voltages and subjection to commercial use shall release the Company from its obligations.
4. This warranty shall become void and cease to operate if the appliance is dismantled by, or any repairs to the appliance are effected by any persons not duly authorised by the Company, or if substitute parts not approved by the Company are used in the appliance, or if the serial number of the appliance is removed.
5. The Company shall not be responsible for damages resulting from fire, flood, civil disturbances or any Act of God. The Company shall not, in terms of these warranties be responsible nor held liable for any consequential loss or damage of any kind caused by or due to the failure or malfunction of the appliance.
6. The Company shall not be responsible for transportation or other costs other than those incurred within the provisions of Point 1 of this Certificate.
7. These warranties shall not apply to the appliance if it is purchased or used beyond the borders of the Republic of South Africa, Namibia, Botswana, Swaziland and Lesotho.
8. Where service is requested under warranty and no fault or defect can be found by the Company, all costs incurred will be for the purchaser's account.
9. This Certificate as well as your invoice will serve as proof of purchase. For the purpose of warranty, it will be essential to produce this Certificate and invoice. Failure to do so, will render the purchaser liable for service costs.

**KEEP THIS CERTIFICATE AND SALES INVOICE AS PROOF OF
PURCHASE FOR WARRANTY PURPOSES.**

Free Manuals Download Website

<http://myh66.com>

<http://usermanuals.us>

<http://www.somanuals.com>

<http://www.4manuals.cc>

<http://www.manual-lib.com>

<http://www.404manual.com>

<http://www.luxmanual.com>

<http://aubethermostatmanual.com>

Golf course search by state

<http://golfingnear.com>

Email search by domain

<http://emailbydomain.com>

Auto manuals search

<http://auto.somanuals.com>

TV manuals search

<http://tv.somanuals.com>