

OWNER'S MANUAL

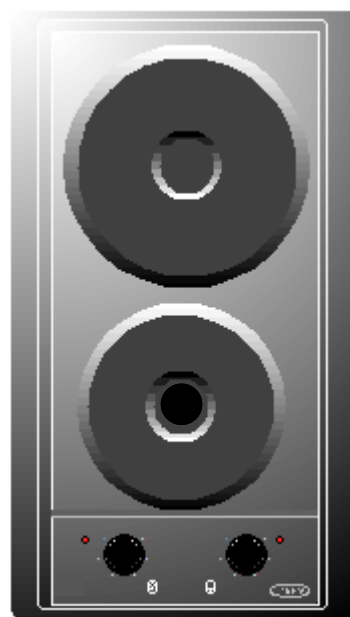

You can rely on Defy. To simplify.

DOMINO RANGE **2 PLATE HOB** **DHD316 BLACK** **DHD317 STAINLESS**



www.defy.co.za

The Manufacturer strives for continuous improvements. For this reason, the text and illustrations in this book are subject to change without notice.

Part Number 067 114

Introduction

Congratulations on the purchase of this quality appliance.

We trust that you will enjoy many years of trouble free use. **Please read these instructions carefully before using the appliance.** This book will provide you with information on how to operate and care for your appliance in order that you gain the maximum benefit from it.

Cupboard requirements

- Cooking appliances generate considerable heat. The layout and materials of the mounting cabinet should take account of these characteristics.
- Surfaces and surrounding edges immediately adjacent to the hob should be able to withstand temperatures of up to 100°C without delaminating or discolouring.
- Allow an unrestricted air space of at least 75mm underneath the underside of the hob for ventilation and cooling purposes.

Future Transportation

Keep the appliances original carton and transport the product in it. Follow the instructions on the carton. If you do not have the original carton, pack the appliance in bubble wrap or thick cardboard and tape it securely.

Secure the caps and pan supports with adhesive tape.

	Check the general appearance of your appliance for any damages that might have occurred during transportation.
---	--

Package information

Packaging materials are dangerous to children. Keep packaging materials in a safe place out of reach of children.

Packaging materials of the appliance are manufactured from recyclable materials.

Do not dispose of the packaging materials together with domestic or other wastes.

Please ensure that packaging material is disposed of in a responsible manner.

Plastic bags should be cut up to prevent children playing with them and accidentally suffocating.

If the appliance is damaged in any way, do not use it. Report the damage to your dealer, who will take the necessary corrective action.

To avoid accidental injury, extreme care should be taken when handling the hob prior to installation as the exposed edges are very sharp.



Disposing of the old product

Dispose of the old appliance in an environmentally friendly manner.

Refer to your local dealer or solid waste collection centre in your area to learn how to dispose of your product.

Before disposing of the product, cut off the power cable plug and make the door lock (if any) unusable to avoid dangerous conditions to children.

Important safety instructions

This section contains safety instructions that will help you avoid risk of injury and damage. All warranties will become void if you do not follow these instructions.

General safety

- **This appliance is not intended for use by persons (including children) with reduced physical, sensory or mental capabilities, or lack of experience and knowledge, unless they have been given supervision or instruction concerning the use of the appliance by a person responsible for their safety. Children should be supervised to ensure that they do not play with the appliance.**
- Connect the appliance to an earthed outlet/line protected by a fuse of suitable capacity. Have the earth installation made by a qualified electrician. Our company shall not be liable for any problems arising due to the appliance not being earthed in accordance with the local regulations.
- If the supply cord is damaged, it must be replaced by the manufacturer, its service agent or similar qualified persons in order to avoid a hazard.
- Do not operate the appliance if it is defective or has any visible damage.
- Do not carry out any repairs or modifications on the appliance. However, some issues may be remedied that do not require any repairs or modifications. See *Troubleshooting*.
- Never wash down the appliance with water! There is the risk of electric shock!
- Never use the appliance when your judgment or coordination is impaired by the use of alcohol and/or drugs.
- The appliance must be disconnected from the mains during installation, maintenance, cleaning and repair procedures.
- Be careful when using alcoholic drinks in your dishes. Alcohol evaporates at high temperatures and may cause a fire since it can ignite when it comes into contact with hot surfaces.
- Do not use the appliance for heating closed tins and glass jars. The pressure that would build up in the tin/jar may cause it to burst.
- Do not place any flammable materials close to the appliance as the sides may become hot during use.
- Keep all ventilation slots clear of obstructions.
- The appliance may be hot when it is in use. Never touch the hot elements/heaters.
- Make sure that the function knobs are switched off after every use.
- Always keep children and infirm persons away from the appliance when it is in use.
- Only use the appliance for preparing food.
- Use a deep pan, large enough to cover the appropriate element.
- Always dry food thoroughly before placing it in hot oil or fat. Frozen food in particular will spit and splatter if added too quickly.
- Never fill the pan more than one third full of fat or oil.
- Never heat fat or fry with a lid on the pan.
- Do not fry too much food at once. This lowers the temperature of the oil or fat and results in fatty foods.
- Do not leave hot fat or oil unattended. If overheating occurs, these could catch fire.
- Do not use or store inflammable products (alcohol, petrol, benzene etc.) near the hob as these pose a fire risk.
- Do not cover the hob or burners with aluminium foil.

Safety for children

- Electrical appliances are dangerous to children. Keep children away from the appliance when it is operating and do not allow them to play with the appliance.
- Accessible parts of the hob will become hot whilst the appliance is in use. Children should be kept away until the appliance has cooled down.
- Do not place any items above the appliance that children may reach for.
- The packaging materials will be dangerous for children. Keep the packaging materials away from children.

In the event of a pan fire

- Switch off the Electricity and or Gas supply.
- Smother the flames with a blanket or damp cloth.
- Burns and injuries are usually caused by picking up the burning pan and rushing outside with it.
- **Do NOT use water to extinguish an oil or fat fire.**

SAVE THESE INSTRUCTIONS

3 Installation

	Preparation of location and electrical and gas installation for the appliance falls under the customer's responsibility.
---	--

	DANGER The appliance must be installed in accordance with all local gas and/ or electrical regulations.
---	---

	DANGER Prior to installation, visually check if the appliance has any defects on it. If so, do not have it installed. Damaged appliances are a safety risk.
---	---

Installation is the buyer's responsibility. The manufacturer accepts no liability for this service. Any action that the manufacturer has to take as a result of an erroneous installation will not be covered by the warranty.

The necessary installation, including gas and electrical connections, must be carried out by qualified personnel in accordance with current and local regulations. An installation by an unqualified person may constitute a hazard.

Installations carried out by unauthorized persons will void the warranty.

The manufacturer shall not be held responsible for injury to persons or damages arising from procedures carried out by unauthorized persons or due to non compliance with these provisions.

Before installation

This appliance is designed for installation in a domestic worktop. A safety distance must be left between the appliance and the kitchen walls and furniture. See figure overleaf (values in mm).

- This appliance can also be used in a free standing position. Allow a minimum distance of 750 mm above the hob surface.
- (*) If a cooker hood is to be installed above the appliance, refer to the cooker hood manufacturers instructions regarding installation height (min 650 mm)
- Remove packaging materials and transport locks.
- Surfaces, synthetic laminates and adhesives used must be heat resistant (100 °C minimum).
- The worktop must be aligned and fixed horizontally.
- Cut the aperture for the hob in the worktop as per installation dimensions.

Electrical installation

This appliance must be earthed. The manufacturer and the seller do not accept responsibility for any damage due to incorrect installation or electrical connection.

Note: The appliance is not intended to be operated by means of an external timer or separate remote-control system.

The hob is fitted with a 15 Amp 3 pin plug which may be inserted into a conveniently located 15A earthed socket located in an easily accessible position, under the counter and in close proximity to the hob.

If the hob is to be permanently connected to the power supply a qualified electrician must install a circuit breaker having a contact opening distance of at least 3 mm. that allows complete disconnection.

Invert the hob on the worktop adjacent to the aperture before making the electrical connection. This will allow sufficient cable length for subsequent servicing.



The power cable plug must be within easy reach after installation (do not route it above the hob).

Installation

- After carrying out the necessary electrical connections, fit the hob sealing putty (supplied) underneath the perimeter rim of the hob and gently lower the hob into and over the cavity in the counter top. See sketch below.
- Secure the hob to the counter top from underneath, using the brackets provided. Securing holes are located at each corner of the hob base for this purpose. See sketch below
- Carefully trim away any putty exposed round the perimeter.

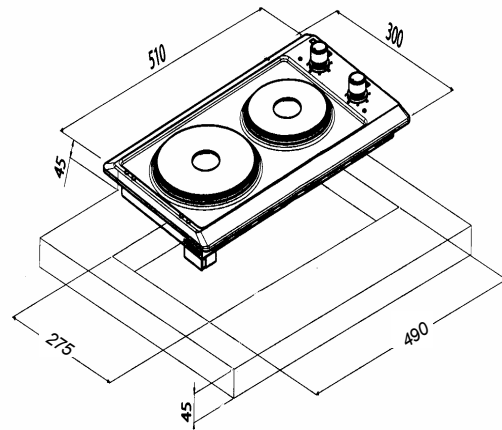

Aperture cut into counter top

 	<p>DANGER Risk of electric shock, short circuit or fire by unprofessional installation!</p> <p>The appliance may be connected to the mains supply only by an authorized qualified person and the appliance is only guaranteed after correct installation.</p>
------	--

 	<p>DANGER Risk of electric shock, short circuit or fire by damage of the mains lead!</p> <p>The mains lead must not be clamped, bent or trapped or come into contact with hot parts of the appliance. If the mains lead is damaged, it must be replaced by a qualified electrician.</p>
------	--

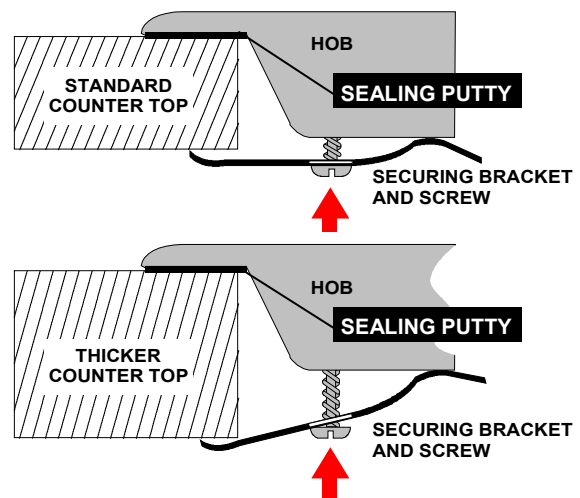

 	<p>DANGER Risk of electric shock! Before starting any work on the electrical installation, please disconnect the appliance from the mains supply.</p>
------	--



Fixing holes are located at each corner of the hob base

How to use the hob

General information about cooking

	DANGER
	Risk of fire by overheated oil! When you heat oil, do not leave it unattended.
	Never try to extinguish a fire with water! When oil has caught fire, immediately cover the pot or pan with a lid. Switch off the hob if safe to do so and phone the fire service.

- Before frying foods, always dry them well and gently place into the hot oil. Ensure complete thawing of frozen foods before frying.
- Do not cover the pot or pan you use when heating oil.
- Place the pans and saucepans in a manner so that their handles are not over the hob to prevent heating of the handles. Do not place unbalanced and easily tilting cooking vessels on the hob.
- Do not place empty pots and saucepans on cooking zones that are switched on. They might get damaged.
- Operating a cooking zone without a pot, pan or saucepan on it will cause damage to the appliance. Turn off the cooking zones after cooking is complete.
- As the surface of the appliance can be hot, do not place plastic and aluminum vessels on it.
- Such vessels should not be used to keep foods in either.
- Use flat bottomed saucepans or cooking vessels only.
- Put only the appropriate amount of food in saucepans and pans. Doing so will assist in you not having to do any unnecessary cleaning as this will help prevent the dishes from overflowing.
- Do not put covers of saucepans or pans on the cooking zones.
- Place saucepans so that they are centered on the cooking zone. When moving the saucepan onto another cooking zone, lift and place it onto the cooking zone you want instead of sliding it.

The control panel

Plate controls

- Select the required heat level by turning the knob to the required setting.
- 1= warming
- 2-3 =simmering
- 4= cooking
- 5-6 = frying and boiling
- An indicator light will glow when the plate is switched on.

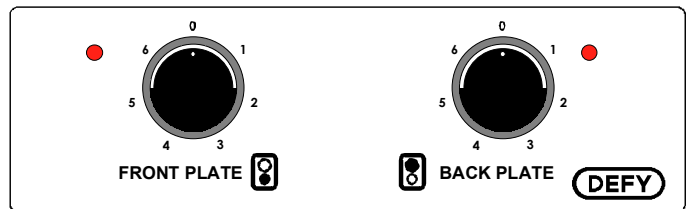

Red dot plate.

- The plate featuring a red dot in the centre is a high speed, high wattage plate for increased performance.
- For your safety this plate is fitted with a thermal limiter. Should the plate be accidentally switched on and left unattended, the limiter will reduce the power output of the plate and minimise the risk of overheating and the possibility of fire.

The hob

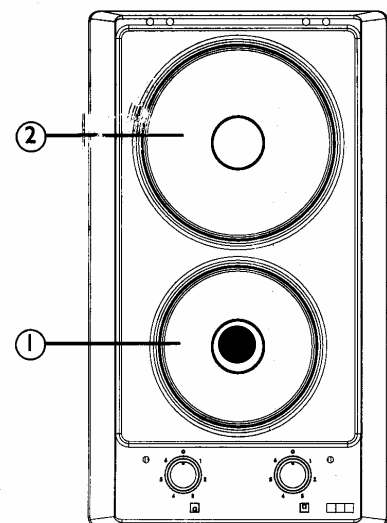





1. **Rear plate 1500W**
2. **Front plate 1500W**

Maintenance and care

General information

The service life of the appliance will extend and the possibility of problems will decrease if the appliance is cleaned at regular intervals.

- Take care to remove any encrustations and ensure that the burner holes are clear.

 	DANGER Risk of electric shock! Switch off the electricity before cleaning the appliance to avoid an electric shock.
 	DANGER Hot surfaces may cause burns! Allow the appliance to cool down before you clean it.

- Clean the appliance thoroughly after each use. In this way it will be possible to remove cooking residues more easily, thus avoiding these from burning the next time the appliance is used.
- No special cleaning agents are required for cleaning the appliance. Use warm water with washing liquid, a soft cloth or sponge to clean the product and wipe it with a dry cloth.
- Always ensure any excess liquid is thoroughly wiped off after cleaning and any spillage is immediately wiped dry.
- Never use high-pressure steam equipment or a water jet for cleaning.
- Do not use cleaning agents that contain acid or chloride to clean the stainless or inox surfaces and the handle. Use a soft cloth with a liquid detergent (not abrasive) to wipe those parts clean, paying attention to sweep in one direction.
- Never use cleaning products containing abrasive materials as these could damage the decorative and informative paint applications.

	Do not use steam cleaners for cleaning.
---	---

	The surface may get damaged by some detergents or cleaning materials. Do not use aggressive detergents, cleaning powder/cream or any sharp objects.
---	--

Cleaning the hob

Gas hobs

1. Remove and clean the saucepan carriers and burner caps.
2. Clean the hob.
3. Install the burner caps and make sure that they are seated correctly.
4. When installing the upper grills, pay attention to place the saucepan carriers so that the burners are centered.

Caring for solid plates

- Before using the plates for the first time, switch them on for about 4 minutes at the highest setting. This allows the factory applied protective coating to burn in. Fumes will be evidenced during this operation but this is normal.
- To prevent blotchy discolouration and corrosion, moisture from spatters and spills should be cleaned off immediately.
- To clean the plates, wipe them with a damp cloth or nylon pad. A little liquid detergent may be used. Do not use metal scourers or sharp metal objects to clean the plates.
- After cleaning, dry the plates by switching them on for a short while.
- To prevent rust, periodically apply some sewing machine oil or electrical hotplate polish - available from Defy Service Centres. Extra attention is required in areas of high humidity or in close proximity to the sea.

DO

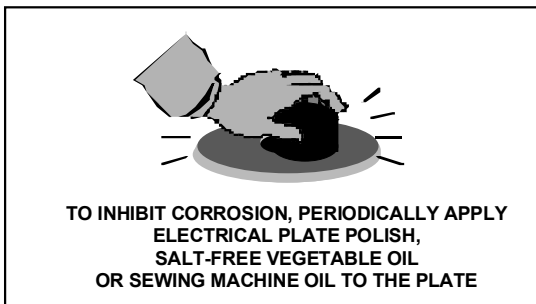
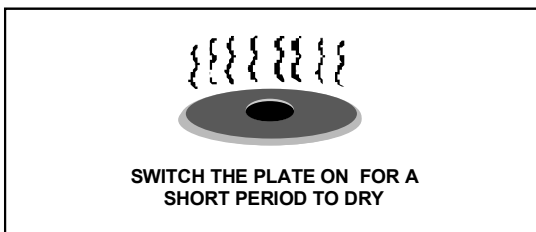
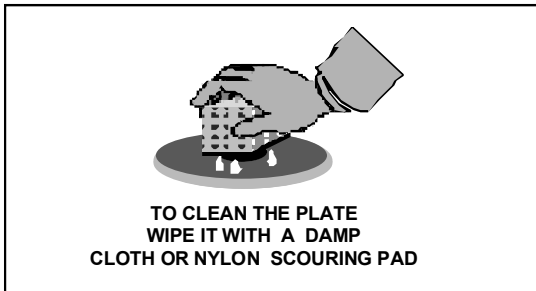
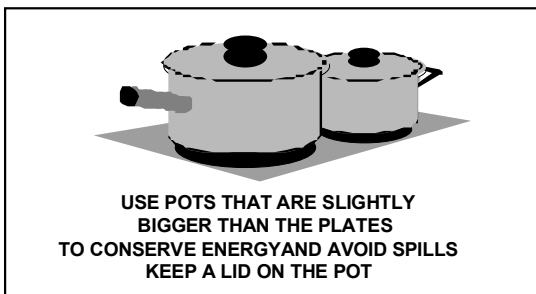

DO NOT

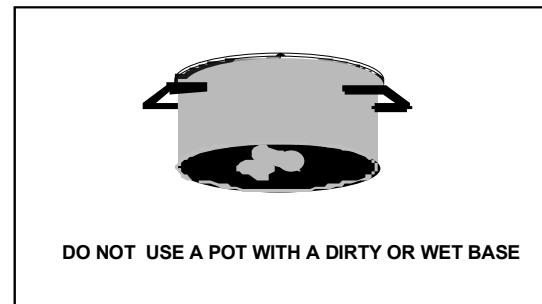
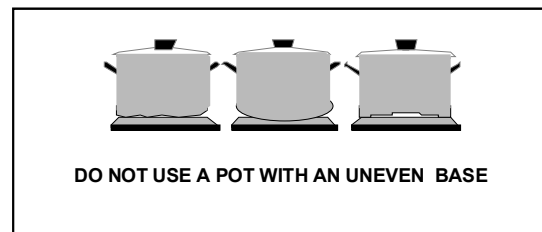
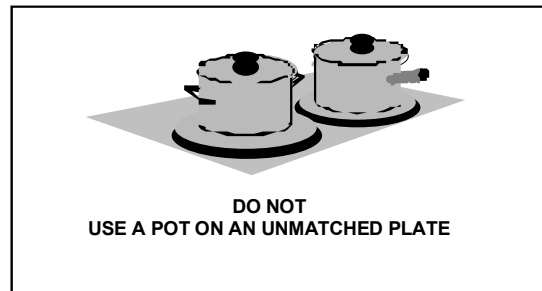
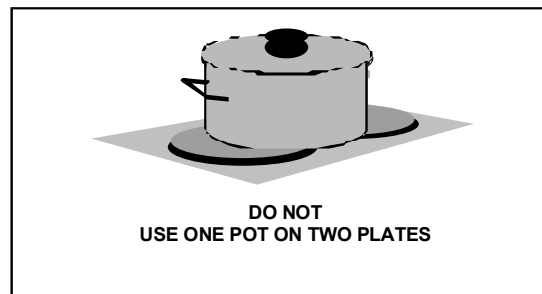

NOTE: THE WARRANTY DOES NOT COVER THE REPLACEMENT OR REPAIR OF RUSTED OR CORRODED PLATES.

Care guide for Stainless Steel model

Stainless steel is not adversely affected by normal household use but because of its reputation for durability, it is sometimes assumed to be indestructible, and therefore subjected to misuse or even abuse.

Care should be taken to avoid such 'abnormal' use.

DO USE

- A soft cloth or synthetic sponge.
- Soap, or mild household detergent. (Handy Andy)
- Diluted ammonia in warm water.
- A nylon bristle brush.
- Cleaners labelled "Suitable for stainless steel".

DO NOT USE

- Acids.
- A steam cleaner.
- Coarse abrasive cleaning powders.
- Metallic scourers, steel wool or metal scrapers.
- Wire brushes or emery paper.
- So called 'silver cleaners'.
- Kitchen scourers / foam pads.

Please note: Some of the suggested procedures in the table below may alter the surface appearance of the treated area.

They should therefore only be applied with careful consideration and care.

CONDITION	ACTION	COMMENTS
Requires routine cleaning	Mild detergent solution applied with soft sponge or cloth. Rinse and wipe dry.	Use warm to hand-hot water. A 5% addition of ammonia is beneficial.
Finger prints	Pre-treat finger marks with alcohol or an organic solvent. Follow immediately with routine cleaning. Wipe with a little baby oil and a soft lint free cloth. Buff to shine	Minimize re-occurrence by applying a wax or silicone based household polish to the clean dry surface. Apply whenever necessary
Stubborn stains and discolouration	Use a little Ceran cleaning paste. (available from Defy Service Centres). Rinse and dry.	Repeat several times rather than resorting to a single aggressive cleaning method
Grease and fat splatter.	Wipe off excess with a soft cloth or paper towel. Use dishwashing liquid. Follow up with routine cleaning.	
Scratches on the brushed finish.	For slight scratches, use a nylon pad loaded with an iron free abrasive polishing compound. Rub in the direction of the original texture. Follow up with routine cleaning. For deep scratches use a coarser abrasive initially and follow up as for light scratches,	Deep scratches will be difficult to remove completely. Do not use steel wool or metal scourers unless they are made from stainless steel.

Frequent cleaning is recommended rather than an occasional aggressive clean. Routine cleaning will preserve the corrosion resistance and appearance of the stainless steel for many years.

Clean the stainless steel as often as necessary and use the simplest cleaning method that will effectively do the job. Use clean water, or a mild detergent solution applied with a soft cloth or sponge. Rinse well and wipe dry.

Trouble shooting

Electric hobs

- Check house fuses or trip switches.
- Check the wall plug by plugging another small appliance into the wall socket.

Gas hob

- Check house fuses or trip switches.
- Check the wall plug by plugging another small appliance into the wall socket.
- Check that there is gas in the bottle and that the valve is open.

Be advised that you may be charged for a service call, even during the warranty period, if the fault is due to or caused by any of the above.



If the problem cannot be remedied after following the troubleshooting problem solving guide, please consult with an authorised service agent or the dealer where you purchased the appliance. Never attempt to repair a defective appliance yourself.

Owner's responsibility

Since the following are not factory faults, they are the owner's responsibility.

- Damage to exterior finish.
- Breakage of glass and other components.
- Damage through improper use or installation of the appliance.
- Damage caused by moving the appliance.
- Rusted or corroded solid plates.

Service Centres

BLOEMFONTEIN 160 Long Street, Hilton,
Bloemfontein 9301.
Tel. 051 400 3900
Bloemfontein.Service@defy.co.za

CAPE TOWN 5A Marconi Rd.
Montague Gardens, 7441.
Tel. 021 528 3000
CapeTown.Service@defy.co.za

DURBAN 35 Intersite Avenue,
Umgeni Business Park, Durban 4051.
Tel. 031 268 3300
Durban.Service@defy.co.za

EAST LONDON 16 Bowls Rd. Arcadia,
East London 5201.
Tel. 043 743 7100
EastLondon.Service@defy.co.za

JOHANNESBURG Cnr. Mimetes & Kruger Sts. Denver ext.12
Commercial Head Office,
Administration, Distribution, National Groups,
Tel. Sales, Contracts and Credit.
Tel. 011 621 0200 or 011 621 0300
Gauteng.Service@defy.co.za

POLOKWANE 87 Nelson Mandela Drive.
Superbia 0699.
Tel. 0152 92 1166 / 7 / 8 / 9.
Polokwane.Service@defy.co.za

PORT ELIZABETH 112 Patterson Road,
North End, Port Elizabeth 6001.
Tel. 041 401 6400
PortElizabeth.Service@defy.co.za

PRETORIA. Block A1 Old Mutual Industrial Park.
Cnr. D.F.Malan Drive & Moot Str.
Hermanstad. 0082.
Tel. 012 377 8300
Pretoria.Service@defy.co.za

**OTHER AREAS ARE SERVICED BY OVER 200 AUTHORISED AGENTS.
FOR FURTHER DETAILS PLEASE CONSULT THE NEAREST REGIONAL
DEFY TECHNICAL SUPPORT CENTRE.**

Warranty

This certificate is issued by DEFY APPLIANCES (PTY) LIMITED manufacturers of Defy and Ocean products, hereinafter the Company, to the original purchaser only, of the appliance described on the certificate and shall constitute the only warranty given in respect of this appliance.

The Company warrants to the original purchaser that for a period of TWO YEARS from date of purchase the appliance is free from defect under normal domestic use, both in workmanship and material, subject to the following conditions.

1. Repair or replacement of any part of this appliance, found by the Company to be defective, shall be at the election of the Company. The Company reserves the right to effect such service through any of its Service Divisions or Authorised Service Dealers. The cost of such service shall be borne by the Company in full, provided that the appliance is located no further than 50 km from a Company Service Centre or an Authorised Service Dealer. Where the appliance is located beyond the 50 km radius, the purchaser shall be liable for the standard travelling charges, as determined by the Company.
2. Rusted or corroded plates, vitreous enamelware, fuses and lamps are specifically excluded from these warranties. It is an express condition of these warranties that the purchaser takes due care and attention in the use and maintenance of the appliance. Abuse, misuse in conflict with operating instructions, connection to incorrect voltages and subjection to commercial use shall release the Company from its obligations.
3. This warranty shall become void and cease to operate if the appliance is dismantled by, or any repairs to the appliance are effected by any persons not duly authorised by the Company, or if substitute parts not approved by the Company are used in the appliance, or if the serial number of the appliance is removed.
4. The Company shall not be responsible for damages resulting from fire, flood, civil disturbances or any Act of God. The Company shall not, in terms of these warranties be responsible nor held liable for any consequential loss or damage of any kind caused by or due to the failure or malfunction of the appliance.
5. The Company shall not be responsible for transportation or other costs other than those incurred within the provisions of Point 1 of this Certificate.
6. These warranties shall not apply to the appliance if it is purchased or used beyond the borders of the Republic of South Africa, Namibia, Botswana, Swaziland and Lesotho.
7. Where service is requested under warranty and no fault or defect can be found by the Company, all costs incurred will be for the purchaser's account.
8. This Certificate as well as your invoice will serve as proof of purchase. For the purpose of warranty, it will be essential to produce this Certificate and invoice. Failure to do so, will render the purchaser liable for service costs.

KEEP THIS CERTIFICATE AND SALES INVOICE AS PROOF OF PURCHASE FOR WARRANTY PURPOSES.

Free Manuals Download Website

<http://myh66.com>

<http://usermanuals.us>

<http://www.somanuals.com>

<http://www.4manuals.cc>

<http://www.manual-lib.com>

<http://www.404manual.com>

<http://www.luxmanual.com>

<http://aubethermostatmanual.com>

Golf course search by state

<http://golfingnear.com>

Email search by domain

<http://emailbydomain.com>

Auto manuals search

<http://auto.somanuals.com>

TV manuals search

<http://tv.somanuals.com>