



DHG118
DHG119



You can rely on Defy. To simplify.

PERMIT NUMBER
1037-39/1-RSA-12-A

HOB DEFY GAS 4 BURNER BLACK/SS

Users Manual

Record in the space below the listed information for future reference. The serial number is on the serial label located on the underside of the hob.

SERIAL NUMBER.....

DATE OF PURCHASE.....

PURCHASED FROM.....

.....

The manufacturer strives for continuous improvement. For this reason, the text and illustrations in this manual are subject to change without notice.

Dear Customer,

Your new Defy appliance was manufactured in a state of the art facility and has passed the strictest quality control procedures.

Please read this manual carefully before installing and using your hob for the first time and then store it within easy reach for future reference. Safety instructions must be strictly followed.

This User Manual may also be applicable for several other models. Differences between models are explicitly identified in the manual.

This manual will provide you with information on how to operate and care for your appliance to gain the maximum benefit from it.

We trust you will enjoy years of trouble free use.

EXPLANATION OF SYMBOLS

Throughout this User Manual the following symbols are used:

 Important information or useful hints about usage.

 Warning for hazardous situations with regard to life and property.

 Warning for electric shock.

 Warning for risk of fire.

 Warning for hot surfaces.

PLEASE REGISTER YOUR PRODUCT AT

www.defy.co.za

DEFY APPLIANCES (PTY) LTD

P.O.BOX 12004

JACOBS

DURBAN

4026

SOUTH AFRICA



Important: Read these instructions for use carefully so as to familiarize yourself with the appliance before connecting it to its gas container. Keep these instructions for future reference.

Table of contents

<u>1 General information</u>	4
Overview	4
Technical specifications	5
Package contents	5
Injector table	5
<u>2 Important safety instructions</u>	6
General safety	6
Safety for children	7
Safety when working with gas	7
If you smell gas	8
Intended use	8
<u>3 Installation</u>	9
Before installation	9
Room ventilation	10
Important information for the installer	10
Important information for the user	11
Electrical connection	12
Gas connection	12
Leakage control	13
Final check	14
Gas conversion	14
Package information	15
Future transportation	15
Disposing of the old product	15
<u>4 Preparation</u>	16
Tips for energy saving	16
Initial use	16
First cleaning of the appliance	16
<u>5 How to use the hob</u>	17
General information about cooking	17
Using the hobs	17
<u>6 Maintenance and care</u>	19
Cleaning the hob	19
Gas jet cleaning procedure	20
<u>7 Troubleshooting</u>	21
<u>8 Service Centres</u>	22
<u>9 Warranty</u>	23
<u>10 Installers details</u>	24

1 General information

Overview

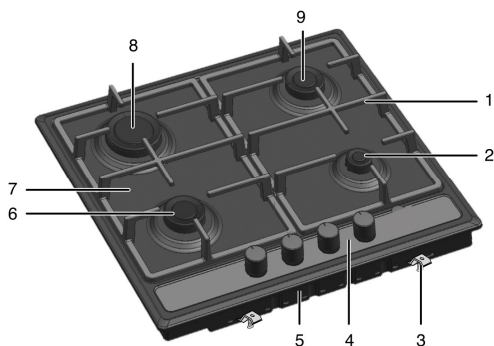

- | | | | |
|---|------------------|---|---------------|
| 1 | Pan support | 6 | Normal burner |
| 2 | Auxiliary burner | 7 | Burner plate |
| 3 | Assembly clamp | 8 | Rapid burner |
| 4 | Control panel | 9 | Normal burner |
| 5 | Base cover | | |

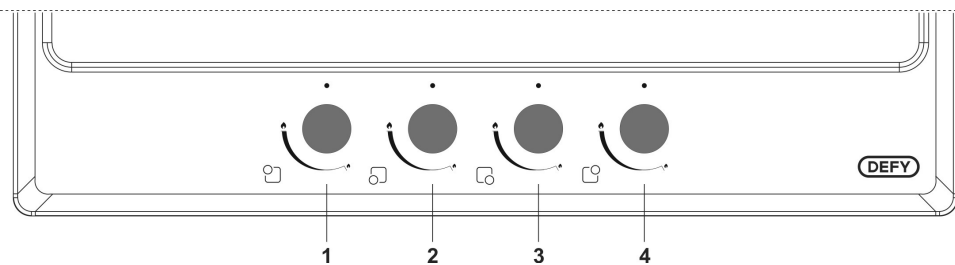

- | | | | |
|---|------------------------|---|------------------------------|
| 1 | Rapid burner Rear left | 3 | Auxiliary burner Front right |
| 2 | Burner Front left | 4 | Normal burner Rear right |



The manufacturer strives for continuous improvement. For this reason, technical specifications, text and illustrations in this manual are subject to change without notice.





Figures in this manual are schematic and may not match your appliance exactly.

Technical specifications	
Voltage / frequency	220-240 V ~ 50 Hz
Cable type / section	H05RR-FG 3 x 1,5 mm ²
Cable length	max. 2 m
Gas type Liquid Petroleum Gas (LPG) / pressure	G30/2.8-3.0 kPa
Total gas consumption	7.4 kW
Converting the gas type Natural Gas (NG) / pressure optional	G20/2.0 kPa
External dimensions (height / width / depth)	99 mm/580 mm/510 mm
Installation dimensions (width / depth)	560 mm/480-490 mm

Burners	
Rear left	Rapid burner
Power	2900 W
Front left	Normal burner
Power	1750 W
Front right	Auxiliary burner
Power	1000 W
Rear right	Normal burner
Power	1750 W

 Technical specifications may be changed without prior notice to improve the quality of the appliance.

 Figures in this manual are schematic and may not exactly match your appliance.

 Values stated on the appliance labels or in the documentation accompanying it are obtained in laboratory conditions in accordance with relevant standards. Depending on operational and environmental conditions of the appliance, these values may vary.

Package contents

 Accessories supplied can vary depending on the appliance model. Not every accessory described in the user manual may exist on your appliance.

Injector table

Position hob zone	2900 W Rear left	1750 W Front left	1000 W Front right	1750 W Rear right
Gas type / Gas pressure				
G 30/2.8-3.0 kPa (for LPG)	85	66	50	66
G20/2.0 kPa (for NG)	125	97	78	97

User manual

2 Important safety instructions

This section contains safety instructions that will help you avoid risk of injury and damage. All warranties will become void if you do not follow these instructions.

General safety

- **This appliance is not intended for use by persons (including children) with reduced physical, sensory or mental capabilities, or lack of experience and knowledge, unless they have been given supervision or instruction concerning the use of the appliance by a person responsible for their safety.**
- **Children should be supervised to ensure that they do not play with the appliance.**
- Connect the appliance to an earthed outlet/line protected by a fuse of suitable capacity. Have the earth installation made by a qualified electrician. Our company shall not be liable for any problems arising due to the appliance not being earthed in accordance with the local regulations.
- If the supply cord is damaged, it must be replaced by the manufacturer, its service agent or similar qualified persons in order to avoid a hazard.
- Do not operate the appliance if it is defective or has any visible damage.
- Do not carry out any repairs or modifications on the appliance. However, some issues may be remedied that do not require any repairs or modifications. See *Troubleshooting*.
- Never wash down the appliance with water! There is the risk of electric shock!
- Never use the appliance when your judgment or coordination is impaired by the use of alcohol and/or drugs.
- The appliance must be disconnected from the mains during installation, maintenance, cleaning and repair procedures.
- Be careful when using alcoholic drinks in your dishes. Alcohol evaporates at high temperatures and may cause a fire since it can ignite when it comes into contact with hot surfaces.
- Do not use the appliance for heating closed tins and glass jars. The pressure that would build up in the tin/jar may cause it to burst.
- Do not place any flammable materials close to the appliance as the sides may become hot during use.
- Keep all ventilation slots clear of obstructions.
- The appliance may be hot when it is in use. Never touch the hot burners, inner sections of the oven, heaters etc.
- Make sure that the function knobs are switched off after every use.
- When using Gas, ensure that the room is well ventilated.
- Always keep children and infirm persons away from the appliance when it is in use.
- Only use the appliance for preparing food.
- Use a deep pan, large enough to cover the appropriate burner.
- Always dry food thoroughly before placing it in hot oil or fat. Frozen food in particular will spit and splatter if added too quickly.
- Never fill the pan more than one third full of fat or oil.
- Never heat fat or fry with a lid on the pan.
- Do not fry too much food at once. This lowers the temperature of the oil or fat and results in fatty foods.
- Do not leave hot fat or oil unattended. If overheating occurs, these could catch fire.
- Do not use or store inflammable products (alcohol, petrol, benzene etc.) near the hob as these pose a fire risk.
- Do not cover the hob or burners with aluminium foil.

Safety for children

- Electrical and/or gas appliances are dangerous to children. Keep children away from the appliance when it is operating and do not allow them to play with the appliance.
- Accessible parts of the hob will become hot whilst the appliance is in use. Children should be kept away until the appliance has cooled down.
- Do not place any items above the appliance that children may reach for.
- The packaging materials will be dangerous for children. Keep the packaging materials away from children. Please ensure that the packaging material is disposed of in a responsible manner.

Safety when working with gas

- Any work carried out on gas equipment and systems may only be done by authorised qualified persons who are **registered LPG Gas installers**.
- Prior to installation, ensure that the local distribution conditions (nature of the gas and gas pressure) and the adjustment of the appliance are compatible.
- This appliance shall be installed and connected in accordance with current installation regulations. Particular attention shall be given to the relevant requirements regarding ventilation; See "*Before installation*".
- **CAUTION:** The use of gas cooking appliances results in the production of heat and moisture in the room in which it is installed. Ensure that the kitchen is well ventilated: keep natural ventilation holes open or install a mechanical ventilation device (mechanical extractor hood). Prolonged intensive use of the appliance may call for additional ventilation, for example increasing the level of the mechanical ventilation where present.



DANGER. Risk of explosion and poisoning!

Put out all naked flames and do not smoke, strike matches or do anything that could cause ignition. Do not operate any electric switches (e.g. light switch, TV, computer, cooker or door bell). Do not use a telephone or mobile phone.

- Gas appliances and systems must be regularly checked for proper functioning. The regulator, hose and its clamp must be checked regularly and replaced within the periods recommended by its manufacturer or when necessary.
- Clean the gas burners regularly. The flames should be blue and burn evenly.
- Good combustion is required in gas appliances. In case of incomplete combustion, carbon monoxide (CO) might develop. Carbon monoxide is a colourless, odourless and very toxic gas, which has a lethal effect even in very small doses.
- Request information about gas emergency telephone numbers and safety measures from your local gas provider in case of a gas smell .

In the event of a pan fire

- Switch off the Gas supply.
- Smother the flames with a blanket or damp cloth.
- Burns and injuries are usually caused by picking up the burning pan and rushing outside with it.
- **Do NOT use water to extinguish an oil or fat fire.**

SAVE THESE INSTRUCTIONS

If you smell gas

- Turn off all valves on gas appliances and gas meter at the main control valve, unless it's in a confined space or cellar.
- Extinguish all naked flames.
- Do not operate any electrical appliances.
- Ventilate the area. Open doors and windows.
- Check for leaks. Check all tubes and connections for tightness.
- If odour persists contact your nearest Defy Service Centre for assistance.
- If you still smell gas leave the property.
- Warn the neighbors.
- Call the fire-brigade. Use a telephone outside the house.
- If you have door or gates that are secured by an electric lock, or entry phone, please open these manually.
- Do not re-enter the property until you are told it is safe to do so.

Action to be taken in the event of a burn back

- In the event of a burn back (where the flame burns back into the jet) immediately turn off the control to the affected burner.
- Wait a few minutes and relight the burner in the normal manner.
- If the burn back occurs again, turn off the control knob to the affected burner, and consult the nearest Defy service technician, who will advise you.

Ventilation

- Room ventilation is vital for the efficient performance of the appliance and for the safety of the occupants in the room in which the appliance is installed.

Intended use

This appliance is designed for domestic use. Commercial use will void the warrantee.

CAUTION: This appliance is for cooking purposes only. It must not be used for other purposes.

This appliance should not be used for warming plates under the grill, drying towels, dish cloths etc. by hanging them on the oven door handles. This product should also not be used for room heating purposes.

The manufacturer shall not be liable for any damage caused by improper use or handling errors.

Safety when working with electricity

Defective electric equipment is one of the major causes of house fires.

- Any work on electrical equipment and systems should only be carried out by authorized and qualified persons.
- In case of any damage, switch off the appliance and disconnect it from the mains. To do this, turn off the fuse at home.
- Ensure that the fuse rating is compatible with the appliance.



IMPORTANT:

If the gas type of the appliance is changed, then the rating plate that shows the gas type of the unit must also be changed.



IMPORTANT:

If the gas type of the appliance is changed, then the sticker that is currently on the underside of the appliance that reads "**Factory adjusted for LPG gas**" must be replaced by the sticker "**Adjusted for natural gas**"

The new sticker can be found in the gas jet kit supplied with the appliance.

3 Installation

Installation is the buyer's responsibility. The manufacturer accepts no liability for this service. Any action that the manufacturer has to take as a result of an erroneous installation will not be covered by the warranty.

The necessary installation, including gas and electrical connections, must be carried out by qualified personnel in accordance with current and local regulations. An installation by an unqualified person may constitute a hazard.

Installations carried out by unauthorized persons will void the warranty.

The manufacturer shall not be held responsible for injury to persons or damages arising from procedures carried out by unauthorized persons or due to non compliance with these provisions.

	Preparation of location and electrical and gas installation for the appliance falls under the customer's responsibility.
--	--

	DANGER The appliance must be installed in accordance with all local gas and/or electrical regulations.
--	--

	DANGER Prior to installation, visually check if the appliance has any defects on it. If so, do not have it installed. Damaged appliances are a safety risk.
--	---

Before installation

This appliance is designed for installation in a domestic worktop. A safety distance must be left between the appliance and the kitchen walls and furniture. See figure overleaf (values in mm).

- This appliance can also be used in a free standing position. Allow a minimum distance of 750 mm above the hob surface.
- (*) If a cooker hood is to be installed above the appliance, refer to the cooker hood manufacturers instructions regarding installation height (min 650 mm)
- Remove packaging materials and transport locks.
- Surfaces, synthetic laminates and adhesives used must be heat resistant (100 °C minimum).
- The worktop must be aligned and fixed horizontally.
- Cut the aperture for the hob in the worktop as per installation dimensions.

This appliance uses LPG (Liquid petroleum or bottle gas)

This appliance requires an operating pressure of 2.8-3.0 kPa. A suitable LPG regulator that complies with the requirements of SANS 1237 must be used.

The manufacturer and the seller do not accept responsibility for any damage due to incorrect installation or gas connection.

- Gas bottles should be located outdoors in a suitable ventilated lock-up.
- The connecting hose should not exceed 125 cm in length.

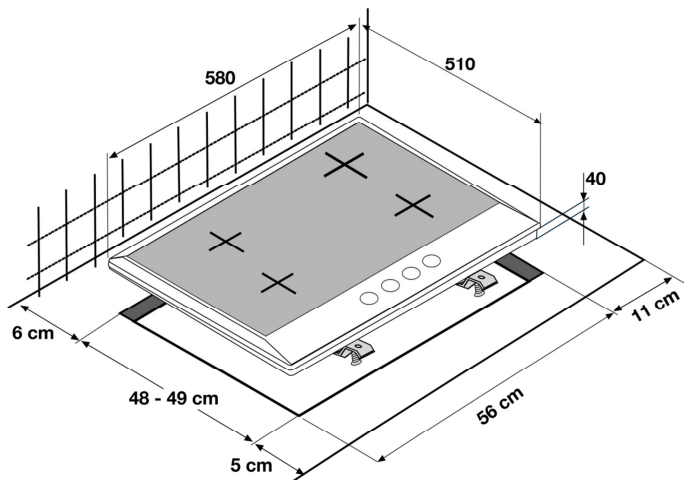

Room ventilation

All rooms require a window that can be opened, or equivalent, and some rooms will require a permanent vent in addition.

Air for combustion is drawn from the room and the exhaust gases are emitted directly into the room, therefore good room ventilation is essential for the safe operation of your appliance. If there is no window or door available for room ventilation, extra ventilation must be installed.

The appliance may be located in a kitchen, kitchen/diner or a bed-sitting room, but not in a room containing a bath or shower. The appliance must not be installed in a bed-sitting room of less than 20m³.

Do not install this appliance in a room below ground level unless it is open to ground level on at least one side.

Room size	Ventilation opening
Smaller than 5 m ³	min. 100 cm ²
5 m ³ to 10 m ³	min. 50 cm ²
Greater than 10 m ³	not required
In the cellar or basement	min. 65 cm ²

Important information for the installer

This appliance may only be installed by a registered LPG Gas installer registered with the LPGSASA. (Liquefied Petroleum Gas Association of Southern Africa).

The appliance must be installed in accordance with the requirements of SANS 10087-1 or SANS 827 and any fire department regulations and/or local bylaws applicable to the area. If in doubt check with the relevant authority before undertaking the installation.

Upon completion of the installation you are required to fully explain and demonstrate to the user the operational details and safety practices applicable to the appliance and the installation including:

- a) The position of the isolation or shut-off valve in the gas supply line to the appliance.
- b) The requirements for safe operation of the appliance

Note.This appliance is supplied ex-factory with jets and air settings for use with LPG gas only.

Note: An appliance without a flame failure device may only be used with a free standing cylinder placed adjacent to but not closer than 300 mm to the appliance.

Safety compliance with local requirements.

Installer's details are to be filled in on page 24 of this book

Temporary installation

Flexible hose connection from the gas appliance to the bottle can be made.

Ensure that pipe clamps are tightened correctly and are of good quality.

- **Flexible hose** - Not supplied.
Any hose that is used to connect the stove to the gas system shall comply with SANS 1156-2 or BS 3212.
- **Gas bottle** - Not supplied.
For best results we recommend that gas cylinders with a minimum capacity of 19kg be used.
- **Regulator** - Not supplied.
A 2.8-3.0 kPa LPG gas regulator which complies with SANS 1237 must be used.

Permanent installation

Important information for the user

This appliance may only be installed by a registered LP Gas installer. All registered installers are issued with a card carrying their registration number.

Ask to be shown this card before allowing the installation to commence and make a note of the installer QCC number on page 24 of this book.

Upon completion of the installation, the installer is required to explain the operational details of the appliance together with the safety instructions. You will be asked to sign acceptance of the installation and be provided with a completion certificate. You should only sign for acceptance when the installation is completed to your satisfaction.

Failure to comply with the above will render the warranty invalid.



Note:



Your invoice is required in the event of you wishing to make a warranty claim.

Electrical connection



Connect the appliance to a grounded outlet/line protected by a fuse of suitable capacity as stated in the "Technical specifications" table. Have the grounding installation made by a qualified electrician while using the product with or without a transformer.

The manufacturer shall not be held responsible for damages arising from procedures carried out by unauthorized persons.

 	DANGER Risk of electric shock, short circuit or fire by unprofessional installation! The appliance may be connected to the mains supply only by an authorized qualified person and the appliance is only guaranteed after correct installation.
--	---

 	DANGER Risk of electric shock, short circuit or fire by damage of the mains lead! The mains lead must not be clamped, bent or trapped or come into contact with hot parts of the appliance. If the mains lead is damaged, it must be replaced by a qualified electrician.
--	---

- Connection must comply with national regulations.
- The mains supply data must correspond to the data specified on the type label of the appliance. Type label is at the rear housing of the appliance.
- Power cable of your product must comply with the values in "Technical specifications" table.

 	DANGER Risk of electric shock! Before starting any work on the electrical installation, please disconnect the appliance from the mains supply.
--	---

	The power cable plug must be within easy reach after installation (do not route it above the hob).
--	--

Plug the power cable into the socket.

Gas connection

	DANGER Risk of explosion or poisoning by unprofessional installation. The appliance may be connected to the gas distribution system only by a registered LPG installer.
---	---

	DANGER Risk of explosion! Before starting any work on the gas installation, please shut off the gas supply.
---	---

- Gas adjustment conditions and values are stated on labels (or on type label).

	Your appliance is adjusted for LPG gas.
---	---

Connecting the gas hose

- Have your appliance connected so that it will be close to the gas connection. Ensure that there is no gas leakage.
- Gas bottles should be located outdoors in a suitable ventilated lock-up.
- The connecting hose to be used must not be longer than 125 cm in length.
- Install the clamp to the hose. Soak one end of the hose (15 mm inner diameter) into hot water for one minute to soften it. Then, slip the softened end of the hose completely onto the sharp hose tip of your appliance.
- Secure the hose by tightening the hose clamp
- Repeat the same procedure for the other end of the hose by securing the other end of the hose to the regulator on the gas bottle to complete the gas cylinder connection.
- Always check for gas leaks after installation and whenever a new or refilled gas bottle is used for the first time.

 **DANGER Risk of explosion and suffocation!**
LPG bottles must not be stored in the house.

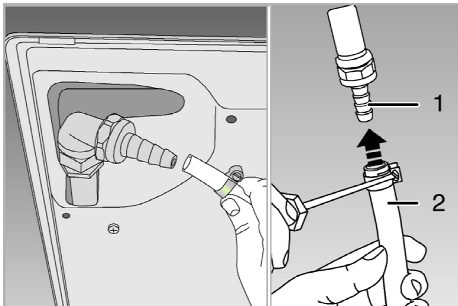

- 1 LPG hose tip
- 2 Plastic hose

Leakage control at the connection point

- Ensure that the control knobs on the hob are in the OFF position.
- Open the valve on the Gas bottle.
- Using a small paint brush, apply some soapy water to all the connections.
- If there is a leak, bubbles will appear.
- If this happens, close the valve on the gas bottle.
- Check and tighten the connections immediately.
- Repeat the procedure to ensure that there are no further leaks.

 **Caution:** Never use a naked flame to check for gas leaks

Installing the appliance

1. Remove burners, burner caps and grills on the hob from the appliance.
2. Turning the hob upside down, place it on a flat surface.
3. In order to avoid foreign substances and liquids penetrating between the hob and the counter, please apply the putty supplied in the package on the contours of the lower housing of the hob, making sure that the putty does not overlap.
4. Apply the putty by bending it around the corners as in the figure.



 Make sure the putty is filled on the base cover contours.

5. Turning the hob again, align and place it on the counter.
6. Secure your hob to the counter by using the clamp and the screws supplied.

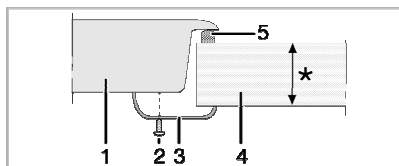

* min. 20 & max. 40 mm

- 1 Hob
- 2 Screw
- 3 Installation clamp
- 4 Counter
- 5 Putty

Rear view (connection holes)

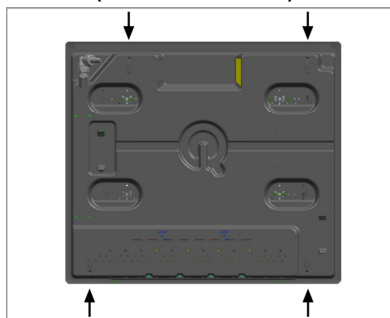



Place the burner plates, burner plate caps and grills back to their seating after installation.

 Making connections to different holes is not a good practice in terms of safety since it can damage the gas and electrical system.



Final check

1. Open gas supply.
2. Check gas installations for secure fitting and tightness.
3. Ignite burners and check appearance of the flame.

	The flames should be blue and burn smoothly. If the flames appear yellowish, check that the burner cap is seated correctly or clean the burner. Switch off the gas and let burner cool before touching it.
--	--

	Unless there is an abnormal condition, do not attempt to remove the gas burner taps. You must call an authorised service agent if it is necessary to change the taps.
	New injectors have their position marked on their packing or refer to the Injector table.

Gas conversion

	DANGER Risk of explosion or poisoning by unprofessional installation. Gas conversion must only be carried out by a registered installer.
	DANGER Risk of explosion! Before starting any work on the gas installation, shut off the gas supply.

In order to have the appliance's gas type changed, all the injectors must be changed and the flame adjustment for all valves must be set at the reduced flow rate position.

Changing the injectors

1. Take off burner cap and burner body.
2. Unscrew injectors by turning them counterclockwise.
3. Fit new injectors.
4. Check all connections for secure fitting and tightness.

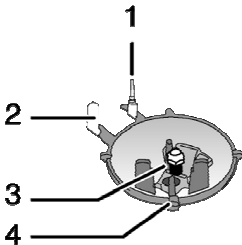

- 1 Flame failure device (model dependent)
- 2 Spark plug
- 3 Injector
- 4 Burner

Reduced gas flow rate setting for taps

1. Ignite the burner that is to be adjusted and turn the knob to the reduced position.
2. Remove the knob from the gas tap.
3. Use an appropriately sized screwdriver to adjust the flow rate adjustment screw. For LPG (Butane - Propane) turn the screw clockwise. For natural gas, you should turn the screw **counter-clockwise** once. The normal length of a straight flame in the reduced position should be 6-7 mm
4. If the flame is higher than the desired position, turn the screw clockwise. If it is smaller turn anticlockwise.
5. For the last control, bring the burner to both the high-flame and reduced positions and check whether the flame is on or off. Depending on the type of gas tap used in your appliance the adjustment screw position may vary.

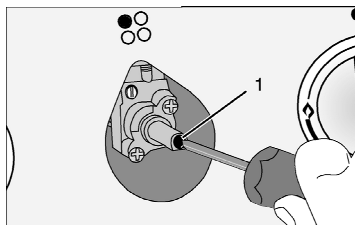
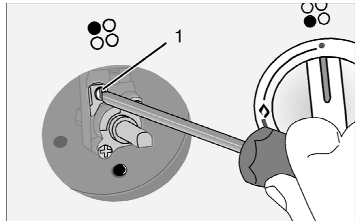

- 1 Flow rate adjustment screw

	If the gas type of the appliance is changed, then the rating plate that shows the gas type of the unit must also be changed.
---	--

	<p>IMPORTANT:</p> <p>If the gas type of the appliance is changed, then the sticker that is currently on the underside of the appliance that reads “Factory adjusted for LPG gas” must be replaced by the sticker “Adjusted for natural gas”.</p> <p>The new sticker can be found in the gas jet kit supplied with the appliance.</p>
---	---

Package information

Packaging materials are dangerous to children. Keep packaging materials in a safe place out of reach of children.

Packaging materials of the appliance are manufactured from recyclable materials.

Do not dispose of the packaging materials together with domestic or other wastes. Dispose of them in a responsible manner.

Future Transportation

Keep the appliances original carton and transport the appliance in it. Follow the instructions on the carton. If you do not have the original carton, pack the appliance in bubble wrap or thick cardboard and tape it securely.

Secure the caps and pan supports with adhesive tape.

Disposing of the old product

Dispose of the old appliance in an environmentally friendly manner.

Refer to your local dealer or solid waste collection centre in your area to learn how to dispose of your appliance.

Before disposing of the appliance, cut off the power cable plug and make the door lock (if any) unusable to avoid dangerous conditions to children.

	<p>Check the general appearance of your appliance for any damages that might have occurred during transportation.</p>
---	---

4 Preparation

Tips for energy saving

The following information will help you to use your appliance in an ecological way, and to save energy:

- Defrost frozen dishes before cooking them.
- Use pots/pans with cover for cooking. If there is no cover, energy consumption may increase up to 4 times.
- Select the burner which is most suitable for the bottom size of the pot to be used. Always select the correct pot size for your dishes. Larger pots require more energy.

Initial use

First cleaning of the appliance





The surface may get damaged by some detergents or cleaning materials.

Do not use aggressive detergents, cleaning powder/cream or any sharp objects.

1. Remove all packaging materials.
2. Wipe the surfaces of the appliance with a damp cloth or sponge and dry with a cloth.

5 How to use the hob

General information about cooking

	DANGER Risk of fire by overheated oil! When you heat oil, do not leave it unattended.
	Never try to extinguish a fire with water! When oil has caught fire, immediately cover the pot or pan with a lid. Switch off the hob if safe to do so and phone the fire service.

- Before frying foods, always dry them well and gently place into the hot oil. Ensure complete thawing of frozen foods before frying.
- Do not cover the pot or pan you use when heating oil.
- Place the pans and saucepans in a manner so that their handles are not over the hob to prevent heating of the handles. Do not place unbalanced and easily tilting cooking vessels on the hob.
- Do not place empty pots and saucepans on cooking zones that are switched on. They might get damaged.
- Operating a cooking zone without a pot, pan or saucepan on it will cause damage to the appliance. Turn off the cooking zones after cooking is complete.
- As the surface of the appliance can be hot, do not place plastic and aluminum vessels on it.
- Such vessels should not be used to keep foods in either.
- Use flat bottomed saucepans or cooking vessels only.
- Put only the appropriate amount of food in saucepans and pans. Doing so will assist in you not having to do any unnecessary cleaning as this will help prevent the dishes from overflowing.
- Do not put covers of saucepans or pans on the cooking zones.
- Place saucepans so that they are centered on the cooking zone. When moving the saucepan onto another cooking zone, lift and place it onto the cooking zone you want instead of sliding it.

Gas cooking

- The size of the cooking vessel and the flame must be suited to each other. Adjust the gas flames so that they do not extend past the bottom of the cooking vessel and ensure that the cooking vessel is centered on the saucepan carrier.

Using the hobs

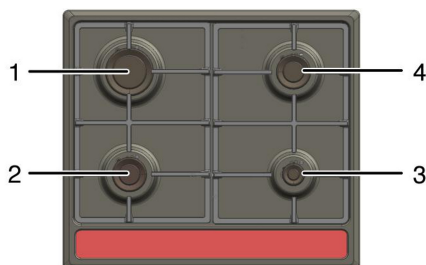

- 1 Rapid burner 20-26 cm
- 2 Normal burner 14-20 cm
- 3 Auxiliary burner 12-18 cm
- 4 Normal burner 14-20 cm
(Advised diameters of pots to be used on related burners).

The large flame symbol indicates the highest cooking power and the small flame symbol indicates the lowest cooking power.

In the turned off position (top), gas is not supplied to the burners.

Igniting the gas burners

1. Keep the burner knob pressed in.
2. Turn the knob counter clockwise to the large flame symbol.
The gas is ignited with the spark created.
3. Adjust the knob to the desired cooking power.

Turning off the gas burners

Turn the keep warm zone knob to off (upper) position.

Gas shut off safety system (in models with thermic component)

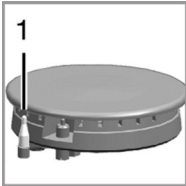

1. Gas shut off safety

As a counter measure against blow out due to fluid overflows at burners or should the flame extinguish for whatever reason, the flow of gas to the burner will automatically be terminated.

- Push the knob inwards and turn it counter clockwise to ignite.
- After the gas ignites, keep the knob pressed for 3-5 seconds more to engage the safety system.
- If the gas does not ignite after you press and release the knob, repeat the same procedure by keeping the knob pressed in for 15 seconds.



DANGER

Risk of deflagration incase of unburned gas!

Do not press the knob for longer than 15 seconds if there was no ignition.

Wait for one minute and then repeat the ignition process.

6 Maintenance and care

General information

The service life of the appliance will extend and the possibility of problems will decrease if the appliance is cleaned at regular intervals.



Service intervals

- Every twelve months the hob should be serviced by a Defy Service agent to ensure continued efficient and safe operation.
- Note: If required, the cleaning of the valves should only be carried out by a qualified Defy technician. i.e. Burner not functioning correctly.
- Removable burner parts should be washed weekly with hot water and detergent.
- Take care to remove any encrustations and ensure that the burner holes are clear.
- The condition of the gas hose and valve should be inspected for leaks every time the gas bottle is re-filled.

- Do not use cleaning agents that contain acid or chloride to clean the stainless or inox surfaces and the handle. Use a soft cloth with a liquid detergent (not abrasive) to wipe those parts clean, paying attention to sweep in one direction.
- Never use cleaning products containing abrasive materials as these could damage the decorative and informative paint applications.
- Remove the burners and wipe them with a thin damp cloth or a non-abrasive sponge. Use a neutral detergent. Dry afterward with a soft cloth and blow away any residual water in the gas outlet holes.

 The surface may get damaged by some detergents or cleaning materials.
Do not use aggressive detergents, cleaning powder/cream or any sharp objects.

 Do not use steam cleaners for cleaning.

	DANGER Risk of electric shock! Switch off the electricity before cleaning the appliance to avoid an electric shock.
	DANGER Hot surfaces may cause burns! Allow the appliance to cool down before you clean it.

Cleaning the hob

Gas hobs

1. Remove and clean the saucepan carriers and burner caps.
2. Clean the hob.
3. Install the burner caps and make sure that they are seated correctly.
4. When installing the upper grills, pay attention to place the saucepan carriers so that the burners are centered.

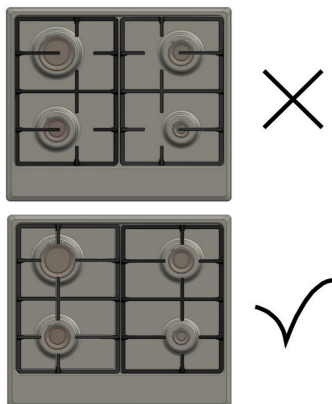

- Clean the appliance thoroughly after each use. In this way it will be possible to remove cooking residues more easily, thus avoiding these from burning the next time the appliance is used.
- No special cleaning agents are required for cleaning the appliance. Use warm water with washing liquid, a soft cloth or sponge to clean the product and wipe it with a dry cloth.
- Always ensure any excess liquid is thoroughly wiped off after cleaning and any spillage is immediately wiped dry.
- Never use high-pressure steam equipment or a water jet for cleaning.

Gas Jet Cleaning Procedure

- Every six months the gas jets on your hob should be cleaned to ensure continued efficient and safe operation.
- This may be done using a Gas Jet Cleaning Kit which may be purchased from your nearest Defy Service Centre.
- The kit comprises of a sliding T-bar (A) a socket (B) and a 'Classic pin' (C).
- **Fit the T-bar to the socket and remove the pot stands, burner caps and burner bodies.**

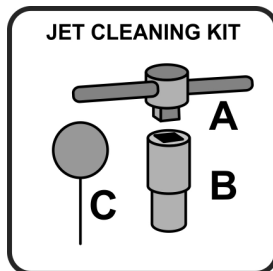

1. Insert the socket into the central tube of the burner so that it locates over the brass gas jet at the bottom of the tube.

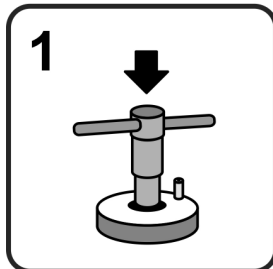

2. Gently loosen the brass gas jet by turning the socket in an anti-clockwise direction.

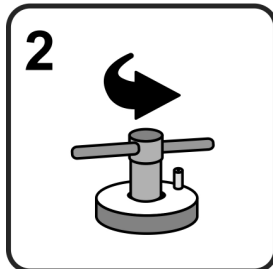

3. Carefully lift the socket and loosened brass gas jet from the central burner tube.

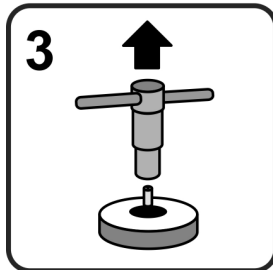

4. Insert the Classic pin into central hole of the jet and slide it up and down until the jet is free of accumulated dirt.
5. Re-assemble in reverse order.
6. Clean all the burner jets in the manner described above.

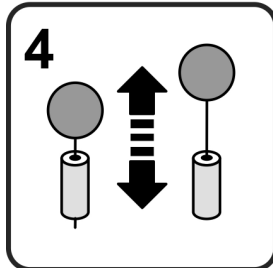

7 Troubleshooting

Problem solving guide—before calling for technical support

There is no gas:	
Main gas valve is closed.	<i>Open gas valve.</i>
Gas pipe is bent.	<i>Ensure the gas pipe has been properly fitted.</i>
There is no ignition spark:	
No current.	<i>Check fuses in the fuse box.</i>
Burners are not burning properly or not at all:	
Burners are dirty.	<i>Clean burner components.</i>
Burners are wet.	<i>Dry the burner components.</i>
Burner cap is not fitted correctly.	<i>Mount the burner cap correctly.</i>
Gas valve is closed.	<i>Open gas valve.</i>
Gas cylinder is empty (when using LPG).	<i>Replace gas cylinder.</i>
The burners will not light:	
The gas pipe is twisted, bent or kinked.	<i>Ensure the gas pipe has been properly fitted.</i>
The burners are dirty or wet.	<i>Clean / dry the burner components.</i>
The gas cylinder is empty.	<i>Replace gas cylinder.</i>
The burner caps are not fitted correctly.	<i>Fit burner caps correctly.</i>
The gas pressure regulator is closed.	<i>Check to see if the regulator is open.</i>
The lighting procedure has not been followed correctly.	<i>Follow the correct lighting procedure.</i>
The flame is yellow	
Pots and pans are stained:	
The burners are dirty or wet.	<i>Clean / dry the burner components.</i>
The gas is running out.	<i>Replace gas cylinder.</i>
The burner caps are not fitted properly.	<i>Fit burner caps properly.</i>
The gas pipe is twisted, bent or kinked.	<i>Ensure the gas pipe has been properly fitted.</i>
Smell of leaking gas:	
Are all the control knobs in the off position?	<i>Check to see the knobs are in the off position.</i>
The gas pipe is fitted incorrectly.	<i>Ensure the gas pipe has been properly fitted.</i>
The hose clamps require tightening or replacing.	<i>Have hose clamps tightened or replaced.</i>
The regulator is faulty and needs to be replaced.	<i>Have regulator checked and replaced.</i>
	If the problem cannot be remedied after following the troubleshooting problem solving guide, please consult with an authorised service agent or the dealer where you purchased the appliance. Never attempt to repair a defective appliance yourself.

8 Service Centres

BLOEMFONTEIN 160 Long Street, Hilton,
Bloemfontein 9301.
Tel. 051 400 3900
Bloemfontein.Service@defy.co.za

CAPE TOWN 5A Marconi Rd.
Montague Gardens, 7441.
Tel. 021 528 3000
CapeTown.Service@defy.co.za

DURBAN 35 Intersite Avenue,
Umgeni Business Park, Durban 4051.
Tel. 031 268 3300
Durban.Service@defy.co.za

EAST LONDON 16 Bowls Rd. Arcadia,
East London 5201.
Tel. 043 743 7100
EastLondon.Service@defy.co.za

JOHANNESBURG Cnr. Mimetes & Kruger Sts. Denver ext.12
Commercial Head Office,
Administration, Distribution, National Groups,
Tel. Sales, Contracts and Credit. Johannesburg. 2094.
Tel. 011 621 0200 or 011 621 0300
Gauteng.Service@defy.co.za

POLOKWANE 87 Nelson Mandela Drive.
Superbia 0699.
Tel. 0152 92 1166 / 7 / 8 / 9.
Polokwane.Service@defy.co.za

PORT ELIZABETH 112 Patterson Road,
North End, Port Elizabeth 6001.
Tel. 041 401 6400
PortElizabeth.Service@defy.co.za

PRETORIA. Block A1 Old Mutual Industrial Park.
Cnr. D.F.Malan Drive & Moot Str.
Hermanstad. 0082.
Tel. 012 377 8300
Pretoria.Service@defy.co.za

**OTHER AREAS ARE SERVICED BY OVER 200 AUTHORISED AGENTS.
FOR FURTHER DETAILS PLEASE CONSULT THE NEAREST REGIONAL
DEFY TECHNICAL SUPPORT CENTRE**

9 Warranty

This certificate is issued by DEFY APPLIANCES (PTY) LTD manufacturers of Defy and Ocean products, hereinafter the Company, to the original purchaser only, of the appliance described on the certificate and shall constitute the only warranty given in respect of this appliance.

The Company warrants to the original purchaser that for a period of TWO YEARS from date of purchase the appliance is free from defect under normal domestic use, both in workmanship and material, subject to the following conditions.

1. Repair or replacement of any part of this appliance, found by the Company to be defective, shall be at the election of the Company. The Company reserves the right to effect such service through any of its Service Divisions or Authorised Service Dealers. The cost of such service shall be borne by the Company in full, provided that the appliance is located no further than 50 km from a Company Service Centre or an Authorised Service Dealer. Where the appliance is located beyond the 50 km radius, the purchaser shall be liable for the standard travelling charges, as determined by the Company.
CARRY IN SERVICE Microwave ovens, Compact cookers and small appliances are repaired in our service centres and are not collected from the customers home. Faulty units should be delivered to the purchasing dealer or to the nearest Company Service Centre for warranty repairs.
2. Rusted or corroded plates, vitreous enamelware, fuses and lamps are specifically excluded from these warranties. It is an express condition of these warranties that the purchaser takes due care and attention in the use and maintenance of the appliance. Abuse, misuse in conflict with operating instructions, connection to incorrect voltages and subjection to commercial use shall release the Company from its obligations.
3. This warranty shall become void and cease to operate if the appliance is dismantled by, or any repairs to the appliance are effected by any persons not duly authorised by the Company, or if substitute parts not approved by the Company are used in the appliance, or if the serial number of the appliance is removed.
4. The Company shall not be responsible for damages resulting from fire, flood, civil disturbances or any Act of God. The Company shall not, in terms of these warranties be responsible nor held liable for any consequential loss or damage of any kind caused by or due to the failure or malfunction of the appliance.
5. The Company shall not be responsible for transportation or other costs other than those incurred within the provisions of Point 1 of this Certificate.
6. These warranties shall not apply to the appliance if it is purchased or used beyond the borders of the Republic of South Africa, Namibia, Botswana, Swaziland and Lesotho.
7. Where service is requested under warranty and no fault or defect can be found by the Company, all costs incurred will be for the purchaser's account.
8. This Certificate as well as your invoice will serve as proof of purchase. For the purpose of warranty, it will be essential to produce this Certificate and invoice. Failure to do so, will render the purchaser liable for service costs.

KEEP THIS CERTIFICATE AND SALES INVOICE AS PROOF OF PURCHASE FOR WARRANTY PURPOSES.

10 Installers Details

Installer's details to be recorded below

INSTALLER'S NAME AND COMPANY.....

.....

INSTALLER'S REGISTRATION NUMBER.....

.....

HAVE YOU RECEIVED A WRITTEN COMPLETION CERTIFICATE?.....

.....

HAS THE INSTALLER EXPLAINED THE OPERATIONAL DETAILS OF YOUR STOVE TO YOU?.....



DHG118
DHG119

You can rely on Defy. To simplify.

Please register your product at
www.defy.co.za

Free Manuals Download Website

<http://myh66.com>

<http://usermanuals.us>

<http://www.somanuals.com>

<http://www.4manuals.cc>

<http://www.manual-lib.com>

<http://www.404manual.com>

<http://www.luxmanual.com>

<http://aubethermostatmanual.com>

Golf course search by state

<http://golfingnear.com>

Email search by domain

<http://emailbydomain.com>

Auto manuals search

<http://auto.somanuals.com>

TV manuals search

<http://tv.somanuals.com>