



DGS162



You can rely on Defy. To simplify.

**PERMIT NUMBER
1037-37/1-RSA-12-A**

STOVE DEFY 5 GAS/ELECTRIC S

Users Manual

Record in the space below the listed information for future reference.

SERIAL NUMBER.....

DATE OF PURCHASE.....

PURCHASED FROM.....

.....

The manufacturer strives for continuous improvement. For this reason, the text and illustrations in this manual are subject to change without notice.

Dear Customer,

Your new Defy appliance was manufactured in a state of the art facility and has passed the strictest quality control procedures.

Please read this manual carefully before installing and using your hob for the first time and then store it within easy reach for future reference. Safety instructions must be strictly followed.

This User Manual may also be applicable for several other models. Differences between models are explicitly identified in the manual.

This manual will provide you with information on how to operate and care for your appliance to gain the maximum benefit from it.

We trust you will enjoy years of trouble free use.

EXPLANATION OF SYMBOLS

Throughout this User Manual the following symbols are used:

 Important information or useful hints about usage.

 Warning for hazardous situations with regard to life and property.

 Warning for electric shock.

 Warning for risk of fire.

 Warning for hot surfaces.

PLEASE REGISTER YOUR PRODUCT AT

www.defy.co.za

DEFY APPLIANCES (PTY) LTD

P.O.BOX 12004

JACOBS

DURBAN

4026

SOUTH AFRICA



Important: Read these instructions for use carefully so as to familiarize yourself with the appliance before connecting it to its gas container. Keep these instructions for future reference.

Table of contents

<u>1 General information</u>	<u>4</u>	<u>6 How to operate the oven</u>	<u>20</u>
Overview	4	General information on baking, roasting and grilling	20
Technical specifications	5	How to operate the electric oven	20
Injector table	5	Operating modes	21
Package contents	6	Using the oven clock	22
<u>2 Important safety instructions</u>	<u>7</u>	Cooking time table	24
General safety	7	How to operate the grill	24
Safety for children	8	Cooking time table for grilling	25
Safety when working with gas	8	<u>7 Maintenance and care</u>	<u>26</u>
If you smell gas	9	General information	26
Action to be taken in event of a burn back	9	Cleaning the hob	26
Intended use	9	Cleaning the oven	26
Safety when working with electricity	9	Removing the oven door	27
<u>3 Installation</u>	<u>10</u>	Removing the door inner glass	27
Before installation	10	Replacing the oven lamp	27
Room ventilation	11	Gas jet cleaning procedure	28
Important information for the installer	12	<u>8 Troubleshooting</u>	<u>29</u>
Important information for the user	12	<u>9 Service Centres</u>	<u>30</u>
Electrical connection	13	<u>10 Warranty</u>	<u>31</u>
Gas connection	13	<u>11 Installers details</u>	<u>32</u>
Leakage control	14		
Final check	15		
Gas conversion	15		
<u>4 Preparation</u>	<u>16</u>		
Tips for energy saving	16		
Initial use	16		
Time setting	16		
First cleaning of the appliance	17		
Initial heating	17		
Package information	17		
Future transportation	17		
Disposing of the old product	17		
<u>5 Using the hob</u>	<u>18</u>		
General information about cooking	18		
Using the hobs	18		

1 General Information

Overview

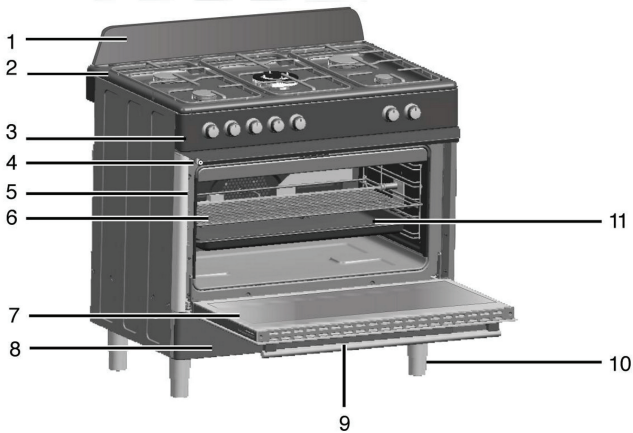

- | | | | |
|---|-----------------|----|-------------|
| 1 | Splashback | 7 | Front door |
| 2 | Burner plate | 8 | Bottom part |
| 3 | Control panel | 9 | Handle |
| 4 | Grill switch | 10 | Foot |
| 5 | Shelf positions | 11 | Tray |
| 6 | Wire shelf | | |

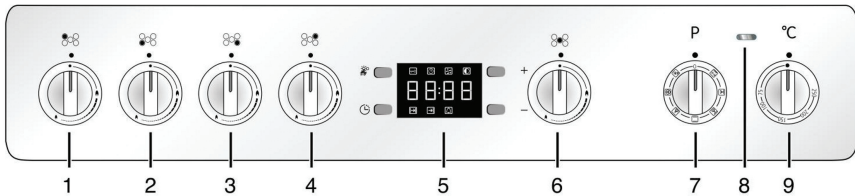

- | | | | |
|---|------------------------------|---|-------------------|
| 1 | Normal burner Rear left | 6 | Wok burner Middle |
| 2 | Normal burner Front left | 7 | Function knob |
| 3 | Auxiliary burner Front right | 8 | Thermostat lamp |
| 4 | Rapid burner Rear right | 9 | Thermostat knob |
| 5 | Digital timer | | |





The manufacturer strives for continuous improvement. For this reason, technical specifications, text and illustrations in this manual are subject to change without notice.



Figures in this manual are schematic and may not match your appliance exactly.

GENERAL	
External dimensions (height / width / depth)	865 mm (min) - 920 mm max//900 mm/655 mm
Voltage / frequency	220-240 V ~ 50 Hz
Total power consumption	2900 W
Fuse	min. 16 A
Cable type / section	H05VV-FG 3G x 1.5 mm ²
Cable length	max. 2 m
Gas type Liquid Petroleum Gas (LPG) / pressure	G30/2.8-3.0 kPa
Total gas consumption	11.5 kW
Converting the gas type Natural Gas (NG) / pressure	G20/2.0 kPa
BURNERS	
Rear left	Normal burner
Power	2000 W
Front left	Normal burner
Power	2000 W
Front right	Auxiliary burner
Power	1000 W
Rear right	Rapid burner
Power	2900 W
Middle	Wok burner
Power	3600 W
OVEN/GRILL	
Main oven	Multifunction oven
Energy efficiency class [#]	B
Inner lamp	15–25 W
Grill power consumption	2500 W

	Technical specifications may be changed without prior notice to improve the quality of the appliance.
	Figures in this manual are schematic and may not match your appliance exactly.

	Values stated on the appliance labels or in the documentation accompanying it are obtained in laboratory conditions in accordance with relevant standards. Depending on operational and environmental conditions of the appliance, these values may vary.
---	---

Injector table

Position hob zone	2000 W Rear left	2000 W Front left	1000 W Front right	2900 W Rear right	3600 W Middle
Gas type / Gas pressure					
G 20/2.0 kPa	103	103	72	115	147
G 30/2.8-3.0 kPa	72	72	50	87	96

Information on the energy label of electrical ovens is given in accordance with the EN 50304 standard. Those values are determined under standard load with bottom-top heater or fan assisted heating (if any) functions.

Package contents

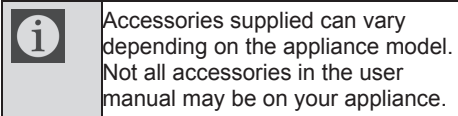

User manual and Oven tray

The oven tray is used for pastries, frozen foods and big roasts.



Wire Shelf

Used for roasting and for placing food to be baked, roasted or cooked in casserole dishes on to the desired rack.

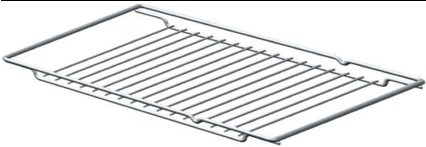
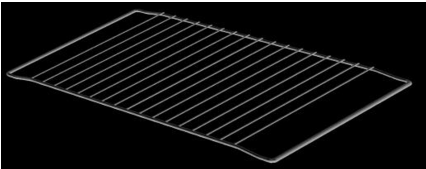

Placing the wire shelf and tray onto the wire racks properly. It is important to place the grill and/or tray onto the rack properly.

Slide the grill or tray between the 2 rails and make sure that it is properly fitted before placing any food on it. (Please see the following figure).

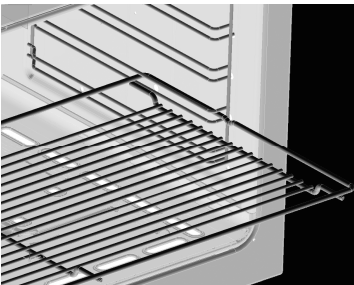

Splash back assembly

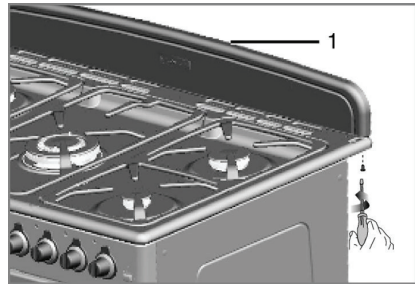

1 Splash back assembly

Remove the splash back assembly from the warmer drawer and remove the packaging taking care to retain the two nuts and bolts required for fixing the splash back to the product. Position the splash back assembly as indicated. Secure the splash back assembly to the hob with the nuts and bolts provided. Do not over tighten the bolts in order to avoid any damages to the hob or splash back assembly.

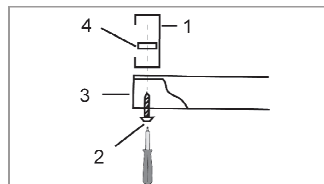
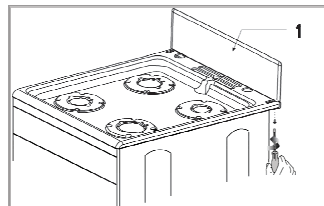

- 1 Splashback
- 2 Screw
- 3 Burner plate
- 4 Nut

If you do not want to install the splashback on to your cooker then place the fillers in the holes. Do not over tighten the screws as damage to the hob or splashback could occur.

2 Important safety instructions

This section contains safety instructions that will help you avoid risk of injury and damage. All warranties will become void if you do not follow these instructions.

General safety

- **This appliance is not intended for use by persons (including children) with reduced physical, sensory or mental capabilities, or lack of experience and knowledge, unless they have been given supervision or instruction concerning the use of the appliance by a person responsible for their safety.**
- **Children should be supervised to ensure that they do not play with the appliance.**
- Connect the appliance to an earthed outlet/line protected by a fuse of suitable capacity. Have the earth installation made by a qualified electrician. Our company shall not be liable for any problems arising due to the appliance not being earthed in accordance with the local regulations.
- If the supply cord is damaged, it must be replaced by the manufacturer, its service agent or similar qualified persons in order to avoid a hazard.
- Do not operate the appliance if it is defective or has any visible damage.
- Do not carry out any repairs or modifications on the appliance. However, some issues may be remedied that do not require any repairs or modifications. See *Troubleshooting*.
- Never wash down the appliance with water! There is the risk of electric shock!
- Never use the appliance when your judgment or coordination is impaired by the use of alcohol and/or drugs.
- The appliance must be disconnected from the mains during installation, maintenance, cleaning and repair procedures.
- Be careful when using alcoholic drinks in your dishes. Alcohol evaporates at high temperatures and may cause a fire since it can ignite when it comes into contact with hot surfaces.
- Do not heat closed tins and glass jars in the oven. The pressure that would build up in the tin/jar may cause it to burst.
- Do not place any flammable materials close to the appliance as the sides may become hot during use.
- Do not place baking trays, dishes or aluminium foil directly onto the bottom of the oven. The heat accumulation might damage the bottom of the oven.
- Keep all ventilation slots clear of obstructions.
- The appliance may be hot when it is in use. Never touch the hot burners, inner sections of the oven, heaters etc.
- Always use heat resistant oven gloves when putting in or removing dishes from the hot oven.
- Do not use the appliance with the front door glass removed or cracked.
- The rear surface of the oven gets hot when it is in use. Make sure that the gas/electrical connection does not come into contact with the rear surface as connections may get damaged.
- Do not trap the mains cable between the oven door and frame and do not route it over hot surfaces as the cable insulation may melt and cause a fire as a result of a short circuit.
- Make sure that the function knobs are switched off after every use.
- When using Gas, ensure that the room is well ventilated.
- Always keep children and infirm persons away from the appliance when it is in use.
- Only use the appliance for preparing food.
- Use a deep pan, large enough to cover the appropriate burner.
- Always dry food thoroughly before placing it in hot oil or fat. Frozen food in particular will spit and splatter if added too quickly.
- Never fill the pan more than one third full of fat or oil.
- Never heat fat or fry with a lid on the pan.
- Do not fry too much food at once. This lowers the temperature of the oil or fat and results in fatty foods.
- Do not leave hot fat or oil unattended. If overheating occurs, these could catch fire.

- Do not use or store inflammable products (alcohol, petrol, benzene etc.) near the appliance as these pose a fire risk.

Safety for children

- Packaging materials are dangerous to children. Keep packaging materials in a safe place out of reach of children.
- Electrical and/or gas products are dangerous to children. Keep children away from the appliance when it is operating and do not allow them to play with the appliance.
- Accessible parts of the appliance will become hot whilst the appliance is in use. Children should be kept away until the appliance has cooled down.
- "CAUTION: Accessible parts may be hot when the grill is in use. Young children should be kept away."
- Do not place any items above the appliance that children may reach for.
- When the door is open, do not load any heavy object on it and do not allow children to sit on it. It may overturn or the door hinges may be damaged.
- The packaging materials are a danger for children. Keep the packaging materials away from children. Please ensure that the packaging material is disposed of in a responsible manner.

Safety when working with gas

- Any work carried out on gas equipment and systems may only be done by authorised qualified persons who are **registered LPG Gas installers**.
- Prior to installation, ensure that the local distribution conditions (nature of the gas and gas pressure) and the adjustment of the appliance are compatible.
- This appliance shall be installed and connected in accordance with current installation regulations.

Particular attention shall be given to the relevant requirements regarding ventilation; See *Before installation*.

CAUTION: The use of gas cooking appliances results in the production of heat and moisture in the room in which it is installed. Ensure that the kitchen is well ventilated: keep natural ventilation holes open or install a mechanical ventilation device (mechanical extractor hood). Prolonged intensive use of the appliance may call for additional ventilation, for example increasing the level of the mechanical ventilation where present.

	<p>DANGER. Risk of explosion and poisoning! Put out all naked flames and do not smoke, strike matches or do anything that could cause ignition. Do not operate any electric switches (e.g. light switch, TV, computer, cooker or door bell). Do not use a telephone or mobile phone.</p>
---	---

- Gas appliances and systems must be regularly checked for proper functioning. The regulator, hose and its clamp must be checked regularly and replaced within the periods recommended by its manufacturer or when necessary.
- Clean the gas burners regularly. The flames should be blue and burn evenly.
- Good combustion is required in gas appliances. In case of incomplete combustion, carbon monoxide (CO) might develop. Carbon monoxide is a colourless, odourless and very toxic gas, which has a lethal effect even in very small doses.
- Request information about gas emergency telephone numbers and safety measures from your local gas provider in case of a gas smell .

In the event of a pan fire

- Switch off the Gas supply.
- Smother the flames with a blanket or damp cloth.
- Burns and injuries are usually caused by picking up the burning pan and rushing outside with it.
- **Do NOT use water to extinguish an oil or fat fire.**

SAVE THESE INSTRUCTIONS

If you smell gas

- Turn off all valves on gas appliances and gas meter at the main control valve, unless it's in a confined space or cellar.
- Extinguish all naked flames.
- Do not operate any electrical appliances.
- Ventilate the area. Open doors and windows.
- Check for leaks. Check all tubes and connections for tightness.
- If odour persists contact your nearest Defy Service Centre for assistance.
- If you still smell gas leave the property.
- Warn the neighbors.
- Call the fire-brigade. Use a telephone outside the house.
- If you have door or gates that are secured by an electric lock, or entry phone, please open these manually.
- Do not re-enter the property until you are told it is safe to do so.

Action to be taken in the event of a burn back

- In the event of a burn back (where the flame burns back into the jet) immediately turn off the control to the affected burner.
- Wait a few minutes and relight the burner in the normal manner.
- If the burn back occurs again, turn off the control knob to the affected burner, and consult the nearest Defy service technician, who will advise you.

Ventilation

- Room ventilation is vital for the efficient performance of the appliance and for the safety of the occupants in the room in which the appliance is installed.

Intended use

This appliance is designed for domestic use. Commercial use will void the warrantee.

CAUTION: This appliance is for cooking purposes only. It must not be used for other purposes.

This appliance should not be used for warming plates under the grill, drying towels, dish cloths etc. by hanging them on the oven door handles. This product should also not be used for room heating purposes.

The manufacturer shall not be liable for any damage caused by improper use or handling errors.

Safety when working with electricity

Defective electric equipment is one of the major causes of house fires.

- Any work on electrical equipment and systems should only be carried out by authorized and qualified persons.
- In case of any damage, switch off the appliance and disconnect it from the mains. To do this, turn off the fuse at home.
- Ensure that the fuse rating is compatible with the appliance.



IMPORTANT:

If the gas type of the appliance is changed, then the rating plate that shows the gas type of the unit must also be changed.



IMPORTANT:

If the gas type of the appliance is changed, then the sticker that is currently on the rear of the appliance that reads "**Factory adjusted for LPG gas**" must be replaced by the sticker "**Adjusted for natural gas**".

The new sticker can be found in the gas jet kit supplied with the appliance.

3 Installation

Installation is the buyer's responsibility. The manufacturer accepts no liability for this service. Any action that the manufacturer has to take as a result of an erroneous installation will not be covered by the warranty.

The necessary installation, including gas and electrical connections, must be carried out by qualified personnel in accordance with current and local regulations. An installation by an unqualified person may constitute a hazard.

Installations carried out by unauthorized persons will void the warranty.

The manufacturer shall not be held responsible for injury to persons or damages arising from procedures carried out by unauthorized persons or due to non compliance with these provisions.

	Preparation of location, electrical and gas installation for the appliance falls under the customer's responsibility.
--	---

	DANGER The appliance must be installed in accordance with all local gas and/or electrical regulations.
--	---

	DANGER Prior to installation, visually check if the appliance has any defects on it. If so, do not have it installed. Damaged appliances are a safety risk.
--	--

Before installation

Please note the appliance is packed without the feet fitted, therefore please ensure the feet are fitted as per the instructions; see Installation and connection, page 13 before the appliance is placed in its final position.

To ensure that critical air gaps are maintained under the appliance, we recommend that this appliance is mounted on a solid base and that the feet do not sink into any carpet or soft flooring.

The kitchen floor must be able to carry the weight of the appliance plus the additional weight of cookware, bakeware and food.

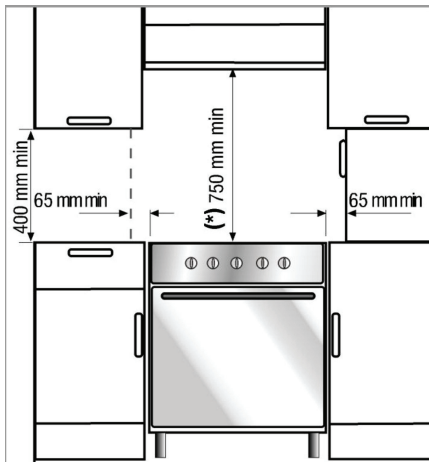

- The appliance can be used with cabinets on either side but in order to have a minimum distance of 400mm above hotplate level allow a side clearance of 65mm between the appliance and any wall, partition or tall cupboard.
- The appliance can also be used in a free standing position. Allow a minimum distance of 750 mm above the hob surface.
- (*) If a cooker hood is to be installed above the cooker, refer to cooker hood manufacturer' instructions regarding installation height (min 650 mm).
- Moving of the appliance is most easily achieved by lifting the front as indicated in the diagrams overleaf. Open the oven door sufficiently to allow a comfortable and safe grip on the underside of the oven roof avoid causing any damage to the grill element or any internal parts of the oven. Do not move by pulling on the door handle or knobs. Move the appliance a bit at a time until placed in the position required.

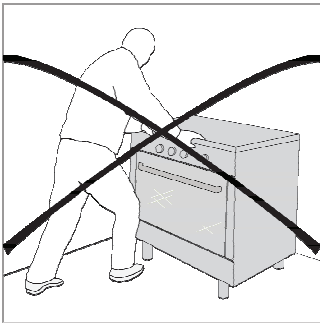
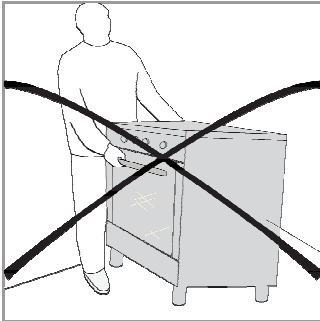
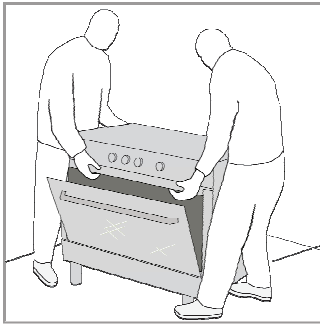

This appliance requires an operating pressure of 2.8-3.0 kPa. A suitable LPG regulator that complies with the requirements of SANS 1237 must be used.

The manufacturer and the seller do not accept responsibility for any damage due to incorrect installation or gas connection.

Gas bottles should be located outdoors in a suitable ventilated lock-up.

The connecting hose should not exceed 125 cm in length.

Room ventilation

All rooms require a window that can be opened, or equivalent, and some rooms will require a permanent vent in addition.

Air for combustion is drawn from the room and the exhaust gases are emitted directly into the room, therefore good room ventilation is essential for the safe operation of your appliance. If there is no window or door available for room ventilation, extra ventilation must be installed.

The appliance may be located in a kitchen, kitchen/diner or a bed-sitting room, but not in a room containing a bath or shower. The appliance must not be installed in a bed sitting room of less than 20m³.

Do not install this appliance in a room below ground level unless it is open to ground level on at least one side.

The appliance corresponds to device class 1, i.e. it may be placed with the rear and one side to kitchen walls, kitchen furniture or equipment of any size. The kitchen furniture or equipment on the other side may only be of the same size or smaller.

Any kitchen furniture next to the appliance must be heat-resistant (100 °C min.).

This appliance uses LPG (Liquid petroleum or bottle gas)

Room size	Ventilation opening
Smaller than 5 m ³	min. 100 cm ²
5 m ³ to 10 m ³	min. 50 cm ²
Greater than 10 m ³	not required
In the cellar or basement	min. 65 cm ²

Important information for the installer

This appliance may only be installed by a registered LPG Gas installer registered with the Liquefied Petroleum Gas Association of Southern Africa.

The appliance must be installed in accordance with the requirements of SANS 10087-1 or SANS 827 and any fire department regulations and/or local bylaws applicable to the area. If in doubt check with the relevant authority before undertaking the installation.

Upon completion of the installation you are required to fully explain and demonstrate to the user the operational details and safety practices applicable to the appliance and the installation including:

- a) The position of the isolation or shut-off valve in the gas supply line to the appliance.
- b) The requirements for safe operation of the appliance

Note. This appliance is supplied ex-factory with jets and air settings for use with LPG gas only.

Safety compliance with local requirements:

Installer's details are to be filled in on page 32 of this book

Temporary installation

Flexible hose connection from the gas appliance to the cylinder can be made. Ensure that pipe clamps are tightened correctly and are of a good quality.

- **Flexible hose** - Not supplied.
Any hose that is used to connect the stove to the gas system shall comply with SANS 1156-2 or BS 3212.
- **Gas cylinder** - Not supplied.
For best results we recommend that gas cylinders with a minimum capacity of 19kg be used.
- **Regulator** - Not supplied.
A 2.8-3.0 kPa LPG gas regulator which complies with SANS 1237 must be used.

Permanent installation

Important information for the user

This appliance may only be installed by a registered LP Gas installer. All registered installers are issued with a card carrying their registration number.

Ask to be shown this card before allowing the installation to commence and make a note of the installer QCC number on page 32 of this book.

Upon completion of the installation, the installer is required to explain the operational details of the appliance together with the safety instructions. You will be asked to sign acceptance of the installation and be provided with a completion certificate. You should only sign for acceptance when the installation is completed to your satisfaction.

Failure to comply with the above will render the warranty invalid.

**Note:
Your invoice is required in the event of you wishing to make a warranty claim.**

Installation and connection

This appliance can only be installed and connected in accordance with the statutory installation rules.



	Do not install the appliance next to refrigerators or freezers. The heat emitted by the appliance will lead to an increased energy consumption of cooling appliances.
--	---



Carry the appliance with at least two persons. The appliance must be placed directly on the floor. It must not be placed onto a base or a pedestal.

	Material damage! The door and/or handle must not be used for lifting or moving the appliance.
--	---



Electrical connection

Connect the appliance to a grounded outlet/line protected by a fuse of suitable capacity as stated in the "Technical specifications" table. Have the grounding installation made by a qualified electrician while using the product with or without a transformer. The manufacturer shall not be held responsible for damages arising from procedures carried out by unauthorized persons.

 	DANGER Risk of electric shock, short circuit or fire by unprofessional installation! The appliance may be connected to the mains supply only by an authorized qualified person and the appliance is only guaranteed after correct installation.
---	---

 	DANGER Risk of electric shock, short circuit or fire by damage of the mains lead! The mains lead must not be clamped, bent or trapped or come into contact with hot parts of the appliance. If the mains lead is damaged, it must be replaced by a qualified electrician.
--	---

- Connection must comply with national regulations.
- The mains supply data must correspond to the data specified on the type label of the appliance. The rating plate is either seen when the door or the lower cover is opened or it is located at the rear wall of the unit depending on the unit type.
- The power cable of your appliance must comply with the values in "Technical specifications" table.

 	DANGER Risk of electric shock! Before starting any work on the electrical installation, please disconnect the appliance from the mains supply.
--	--

	The power cable plug must be within easy reach after installation (do not route it above the stove)
---	---

- Plug the power cable into the socket.

Gas connection

	DANGER Risk of explosion or poisoning by unprofessional installation. The appliance may be connected to the gas distribution system only by a registered LPG installer.
---	---

	DANGER Risk of explosion! Before starting any work on the gas installation, please shut off the gas supply.
---	---

- Gas adjustment conditions and values are stated on labels (or on type label).

	Your appliance is adjusted for LPG gas.
---	---

After selecting a suitable location for the gas cylinder, interchange the sharp hose tip and the blind plug at the rear of your oven (if necessary) to suit the cylinder location.

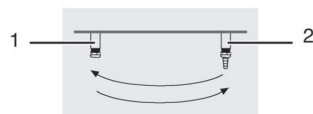

- 1 Blind plug
- 2 Hose tip

Connecting the gas hose

- Have your appliance connected so that it will be close to the gas connection. Ensure that there is no gas leakage.
- Gas bottles should be located outdoors in a suitable ventilated lock-up.
- The connecting hose to be used must not be longer than 125 cm in length.
- Fit the clamp to the hose. Soak one end of the hose (15 mm inner diameter) into hot water for 60 seconds to soften, then slip the softened end of the hose completely onto the sharp hose tip of the appliance.
- Secure the hose by tightening the hose clamp.
- Repeat the same procedure for the other end of the hose by securing it to the regulator on the gas bottle to complete the gas cylinder connection.
- Always check for gas leaks after installation and whenever a new or refilled gas bottle is used for the first time.

	DANGER Risk of explosion and suffocation! LPG bottles must not be stored in the house.
--	---

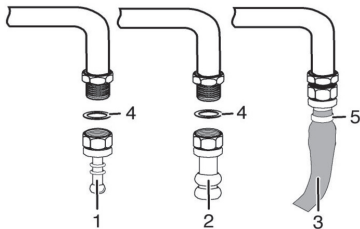

1. Hose tip-LPG
2. Hose tip-NG
3. Safety hose
4. O-ring (gasket)
5. Clamp

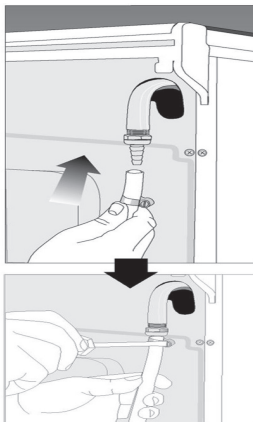

Leakage control at the connection point

- Ensure that the control knobs on the hob are in the OFF position.
- Open the valve on the Gas bottle.
- Using a small paint brush, apply some soapy water to all the connections.
- If there is a leak, bubbles will appear.
- If this occurs, close the gas bottle valve .
- Check and tighten the connections immediately.
- Repeat the procedure to ensure that there are no further leaks.

	Caution: Never use a naked flame to check for gas leaks
	DANGER Risk of explosion by damage of the safety tube! The safety tube must not be clamped, bent or trapped or come into contact with hot parts of the appliance.

- Push the product towards the kitchen wall.

Adjusting the feet of oven

Level the appliance to ensure stability of cooking vessels whilst cooking.

For your own safety please ensure the product is level by adjusting the four feet at the bottom by turning left or right and align level with the work top.

4 feet are supplied together with your oven. Each foot must be installed into its respective slot located at the 4 corners under the oven.

Screw the thread of the foot by turning in clockwise.

For your safety, make sure that all 4 feet are level when screwing in. An oven that is not level will have an adverse effect on cooking.

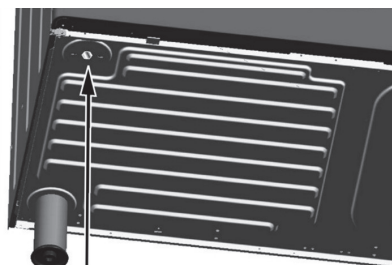



- 1 Foot
- 2 Foot slot



Final check

1. Open gas supply.
2. Check gas installations for secure fitting and tightness.
3. Ignite burners and check appearance of the flame.

	The flames should be blue and burn smoothly. If the flames appear yellowish, check that the burner cap is seated correctly or clean the burner. Switch off the gas and let burner cool before touching it.
--	--

	Unless there is an abnormal condition, do not attempt to remove the gas burner taps. You must call an authorised service agent if it is necessary to change the taps.
	New injectors have their position marked on their packing or refer to the Injector table.

Gas conversion

	DANGER Risk of explosion or poisoning by unprofessional installation. Gas conversion must only be carried out by a registered installer.
	DANGER Risk of explosion! Before starting any work on the gas installation, shut off the gas supply.

In order to have the appliance's gas type changed, all the injectors must be changed and the flame adjustment for all valves must be set at the reduced flow rate position.

Changing the injectors

1. Take off burner cap and burner body.
2. Unscrew injectors by turning them counterclockwise.
3. Fit new injectors.
4. Check all connections for secure fitting and tightness.

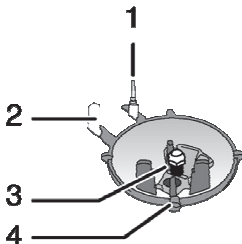

- 1 Flame failure device (model dependent)
- 2 Spark plug
- 3 Injector
- 4 Burner

Reduced gas flow rate setting for taps

1. Ignite the burner that is to be adjusted and turn the knob to the reduced position.
2. Remove the knob from the gas tap.
3. Use an appropriately sized screwdriver to adjust the flow rate adjustment screw. For LPG (Butane - Propane) turn the screw clockwise. For natural gas, you should turn the screw **counter-clockwise** once. The normal length of a straight flame in the reduced position should be 6-7 mm
4. If the flame is higher than the desired position, turn the screw clockwise. If it is smaller turn anticlockwise.
5. For the last control, bring the burner to both the high-flame and reduced positions and check whether the flame is on or off. Depending on the type of gas tap used in your appliance the adjustment screw position may vary.

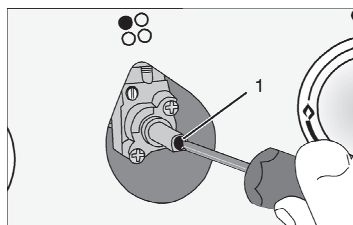
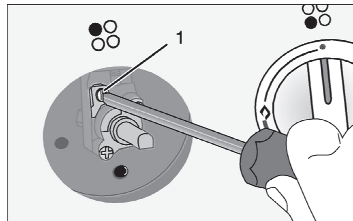

- 1 Flow rate adjustment screw

	If the gas type of the appliance is changed, then the rating plate that shows the gas type of the unit must also be changed.
---	--

4 Preparation

Tips for saving energy

The following information will help you to use your appliance in an ecological way, and to save energy:

- Use dark coloured or enamel coated cookware in the oven for better heat transmission.
- Before cooking your dishes, perform a preheating operation if it is advised in the user manual or cooking instructions.
- Do not open the door of the oven frequently during cooking.
- Try to cook more than one dish in the oven at the same time whenever possible. Two cooking vessels can be placed onto the wire shelf.
- Cook more than one dish one after another. The oven will already be hot.
- Save energy by switching off your oven a few minutes before the end of the cooking time. Do not open the oven door.
- Defrost frozen dishes before cooking them.
- Use pots and pans with covers for cooking. If there is no cover, energy consumption may increase by 4 times.
- Select the burner which is suitable for the bottom size of the pot that is to be used. Always select the correct pot size for your dishes. Larger pots require more energy.

Initial use

Time setting

	Before using the oven the clock time must be set. If the clock time is not set, the main oven will not work.
--	--

	While making any adjustment, related symbols on the clock will flash.
--	---

Press '-' or '+' (5/6) keys to set the time after the oven is energized for the first time

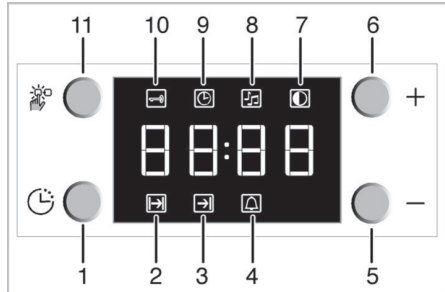

- 1 Program key
- 2 Cooking time
- 3 End of cooking time
- 4 Alarm
- 5 Minus key
- 6 Plus key
- 7 Screen brightness setting
- 8 Alarm volume
- 9 Current time
- 10 Keylock
- 11 Adjustment key

After setting the time, cooking can be started or ended by selecting the desired position with the temperature button and the function button.

	If the current time is not set, time setting will start increasing/moving up from the 12:00. clock symbol. '9' will be displayed to indicate that the current time has not been set. This symbol will disappear once the time is set.
--	---

	Time settings are cancelled in case of a power failure and will need to be reset.
---	---

Changing the time

To change the time that has been previously set:

1. Press (11) key to activate current time symbol '9'.
2. Press '-' or '+' (5/6) keys to set the current time.

Changing screen brightness adjustment

1. Press (11) key to activate screen brightness symbol '7' for screen brightness adjustment.
2. Press '-' or '+' (5/6) keys to set the desired brightness.
» Selected brightness level will appear as d-01, d-02 or d-03 on the display.



First cleaning of the appliance

	The surface of the appliance may be damaged by some detergents or cleaning materials. Do not use aggressive detergents, cleaning powder, cream or any sharp objects.
--	--

1. Remove all packaging materials.
2. Wipe the surfaces of the appliance with a damp cloth or sponge and dry with a cloth.

Initial heating

Heat up the appliance for about 30 minutes and then switch it off. This will ensure that any production residues or layers will be burnt off and removed.

	WARNING Hot surfaces may cause burns! Do not touch the hot surfaces of the appliance. Use oven gloves. Keep children away from the appliance.
	

Electric oven

1. Take all baking trays and the wire grill out of the oven.
2. Close the oven door.
3. Select the static position.
4. Select the highest grill power; See How to operate the electric oven, page 20.
5. Operate the oven for about 30 minutes.
6. Turn off your oven; See How to operate the electric oven, page 20.

Grill oven

1. Take all baking trays and the wire grill out of the oven.
2. Close the oven door.
3. Select the highest grill power; see How to operate the grill, page 24.
4. Operate the grill about 30 minutes.
5. Turn off your grill; see How to operate the grill, page 24

	Smell and smoke may emit during the first heating. This is not a fault and is quite normal and is due to any production residues or layers being burnt off and removed. Ensure that the room is well ventilated.
---	--

Package information



Packaging materials are dangerous to children. Keep packaging materials in a safe place out of reach of children. Packaging materials of the appliance are manufactured from recyclable materials. Do not dispose of the packaging materials together with domestic or other wastes. Dispose of them in a responsible manner.

Future Transportation

Keep the appliances original carton and transport the appliance in it. Follow the instructions on the carton. If you do not have the original carton, pack the appliance in bubble wrap or thick cardboard and tape it securely.

To prevent the wire grill and tray inside the oven from damaging the oven door, place a strip of cardboard onto the inside of the oven door that lines up with the position of the trays. Tape the oven door to the side walls. Secure the caps and pan supports with adhesive tape.

Do not use the door or handle to lift or move the appliance.

	Check the general appearance of your appliance for any damages that might have occurred during transportation.
	Do not place other items on the top of the appliance. The appliance must be transported upright.

Disposing of the old product



Dispose of the old appliance in an environmentally friendly manner.

Refer to your local dealer or solid waste collection centre in your area to learn how to dispose of your product.

Before disposing of the product, cut off the power cable plug and make the door lock (if any) unusable to avoid dangerous conditions to children.

5 Using the hob

General information about cooking

	DANGER Risk of fire by overheated oil! When heating oil, do not leave it unattended.
	Never try to extinguish a fire with water! When oil has caught fire, immediately cover the pot or pan with a lid. Switch off the hob if safe to do so and phone the fire service.

- Before frying foods, always dry them well and gently place into the hot oil. Ensure complete thawing of frozen foods before frying.
- Do not cover the pot or pan being used when heating oil.
- Place the pans and saucepans in a manner so that their handles are not over the hob to prevent heating of the handles. Do not place unbalanced and easily tilting cooking vessels on the hob.
- Do not place empty pots and saucepans on cooking zones that are switched on. They might get damaged.
- Operating a cooking zone without a pot, pan or saucepan on it may cause damage to the appliance. Turn off the cooking zones after cooking is complete.
- As the surface of the appliance can be hot, do not place plastic and aluminum vessels on it.
- Plastic and aluminum vessels should not be used to keep foods in.
- Use flat bottomed saucepans or cooking vessels only.
- Place only the appropriate amount of food in saucepans and pans. Doing so will assist with regards to not having to do any unnecessary cleaning as this will help prevent the dishes from overflowing.
- Do not put covers of saucepans or pans on the cooking zones.
- Place saucepans so that they are centered on the cooking zone. When moving the saucepan onto another cooking zone, lift and place it onto the other cooking zone instead of sliding it.

Gas cooking

- The size of the cooking vessel and the flame must be suited to each other. Adjust the gas flames so that they do not extend past the bottom of the cooking vessel and ensure that the cooking vessel is centered on the saucepan carrier.

Using the hobs

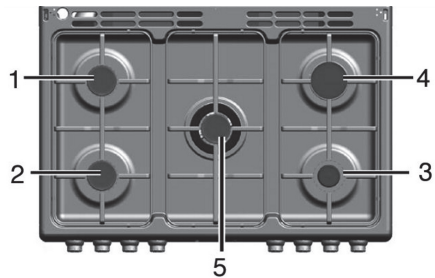

- 1 Normal burner 20–22 cm
- 2 Normal burner 20–22 cm
- 3 Auxiliary burner 12–14 cm
- 4 Rapid burner 20–22 cm
- 5 Wok burner 22-24 cm

The above list denotes the recommended diameters of pots to be used on related burners.

The large flame symbol indicates the highest cooking power and small flame symbol indicates the lowest cooking power. In the turned off position (top), gas is not supplied to the burners.

Igniting the gas burners

1. Keep the burner knob pressed in.
2. Turn the knob counter clockwise to the large flame symbol. Gas is ignited with the spark created.
3. Adjust the knob to the desired cooking power.

Turning off the gas burners

Turn the keep warm zone knob to the off (upper) position.

Gas shut off safety system (in models with thermic component)



1. Gas shut off safety

As a counter measure against blow out due to fluid overflows at burners or should the flame extinguish for whatever reason, the flow of gas to the burner will automatically be terminated.

- Push the knob inwards and turn it counter clockwise to ignite.
- After the gas ignites, keep the knob pressed for 3-5 seconds more to engage the safety system.
- If the gas does not ignite after you press and release the knob, repeat the same procedure by keeping the knob pressed in for 15 seconds.



DANGER

Risk of deflagration in case of unburned gas!

Do not press the knob for longer than 15 seconds if there was no ignition.

Wait for one minute and then repeat the ignition process.

Wok burner





Wok burners help you to cook faster. Wok, which is particularly used in Asian kitchens, is a kind of deep and flat fry-pan made of sheet metal. These are used to cook minced vegetables and meat in a short time using a strong flame.



Since meals are cooked using a strong flame and in a very short time, and as such fry-pans conduct heat rapidly and evenly, the nutritional value of the food is preserved and vegetables remain crispy.

The wok burner can be used for regular saucepans too.

6 How to operate the oven

General information on baking, roasting and grilling

 	WARNING Hot surfaces may cause burns! Do not touch the hot surfaces of the appliance. Use oven gloves. Keep children away from the appliance.
--	--

 	DANGER Risk of scalding by hot steam! Take care when opening the oven door as steam may escape.
--	--

Tips for baking



- Use non-sticky coated appropriate metal plates or aluminum vessels or heat resistant silicone moulds.
- Make best use of the space on the rack.
- Place the baking mould in the middle of the shelf.
- Select the correct rack position before turning the oven or grill on. Do not change the rack position when the oven is hot.
- Keep the oven door closed.

Tips for roasting

- Treating whole chicken, turkey and large pieces of meat with dressings such as lemon juice and black pepper before cooking will increase the cooking performance.
- It takes about 15 to 30 minutes longer to roast meat with bones when compared to roasting the same size of meat without bones.
- Each centimeter of meat thickness requires approximately 4 to 5 minutes of cooking time.
- Let meat rest in the oven for about 10 minutes after the cooking time is over. The juice is better distributed all over the roast and does not run out when the meat is cut.
- Fish should be placed on the middle or lower rack in a heat-resistant plate.

Tips for grilling

- When meat, fish and poultry are grilled, they quickly get brown and develop a crust and do not easily dry out. Flat cuts of meat, sausages and meat skewers are particularly suited for grilling as are vegetables with high water content such as tomatoes and onions.
- Distribute the pieces to be grilled on the wire shelf or in the baking tray in such a way that the area covered does not exceed the size of the heater.
- Slide the wire shelf or baking tray into the desired level in the oven. If you are grilling on the wire shelf, slide the baking tray to the lower rack to collect fats. Add some water in the tray for easy cleaning.

 	Fire danger due to food which is unsuitable for grilling! Only use food for grilling which is suitable for intensive grilling heat. Do not place the food too far in the back of the grill. This is the hottest area and fat food may catch fire
--	--

How to operate the electric oven

	Before using the oven the clock time must be set. If the clock time is not set, the main oven will not work.
---	--

Select temperature and operating mode

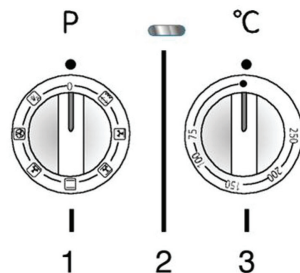

- 1 Function knob
- 2 Thermostat lamp
- 3 Thermostat knob

1. Set the Temperature knob to the desired temperature.
2. Set the Function knob to the desired operating mode.

The oven heats up to the adjusted temperature and maintains it. During heating, the temperature lamp stays on.

Switching off the electric oven

Turn the function knob and temperature knob to the off (upper) position.

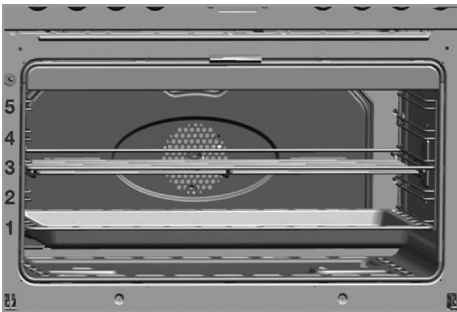

**Rack positions
(For models with wire shelf)**

Operating modes

The order of operating modes shown here may be different from the arrangement on your product.

Top and bottom heating



Top and bottom heating are in operation.

The food is heated simultaneously from the top and bottom. Top and bottom heating is suitable for cakes, pastries, or cakes and casseroles in baking moulds.

Cook with one tray only in this mode.

Fan supported bottom/top heating



Top heating, bottom heating plus fan (in the rear wall) are in operation. Hot air is evenly distributed throughout the oven rapidly by means of the fan.

Cook with one tray only in this mode.

Fan assisted top heating



Top heating and the fan (in the rear wall) are both in operation. Hot air is distributed better with the fan on when compared to having only the top heating in operation.

Fan assisted bottom heating



Bottom heating and the fan (in the rear wall) are both in operation. Hot air is distributed better with the fan on when compared to having only the bottom heating in operation.

Operating with fan



The oven is not heated. Only the oven lamp and the fan (in the rear wall) are in operation. Suitable for thawing frozen granular food slowly at room temperature and cooling down food that has just been cooked.

Thermofan



Warm air heated by the rear heater is evenly distributed throughout the oven rapidly by means of the fan. It is suitable for cooking your meals on different rack levels. Preheating is not required in most cases.

Suitable for cooking with multi trays.

Full grill



This mode is suitable for grilling.

Using the oven clock

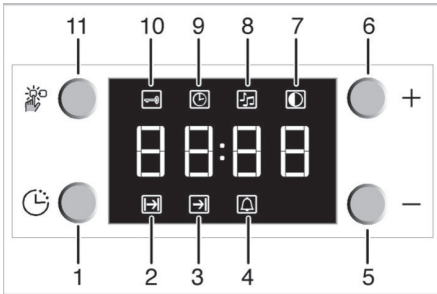

- 1 Program key
- 2 Cooking time
- 3 End of cooking time
- 4 Alarm
- 5 Minus key
- 6 Plus key
- 7 Screen brightness setting
- 8 Alarm volume
- 9 Current time
- 10 Keylock
- 11 Adjustment key

	The maximum time to be set for the end of the cooking process is 5 hours and 59 minutes. In case of a power cut, the program will be canceled. A reprogram will then be required.
	While making any adjustments, related symbols will flash on the display. Wait for a short period for the settings to take effect
	If no cooking setting is made, the time of the day cannot be set.
	The cooking time will display once the cooking starts.

Cooking by specifying the cooking time:

The oven can be set so that it will stop at the end of the specified time by setting the cooking time on the clock.

1. To adjust the cooking time, Press the program key (1) and activate the Cooking Time symbol (2).
2. Press '-' / '+' (5/6) keys to set the cooking time.

Once the cooking time is set, the cooking symbol will be displayed continuously.

Set the end of cooking time to a later time:

After setting the cooking time on the clock, the end of cooking time can be set to a later time.

1. To adjust the cooking time, press the program key (1) and activate the cooking time symbol (2).
2. Adjust the cooking time with minus (5) and plus (6) keys.

The cooking time symbol remains lit (displays continuously) after setting the cooking time.

3. To set the end of cooking time, press program key (1) and activate the cooking time symbol (3).
4. Press - (5) and + (6) keys to set the end of cooking time.

Once the end of cooking time is set, the end of cooking symbol and the cooking symbol will be displayed continuously. The end of cooking time symbol (3) will disappear as soon as the cooking starts.

5. Place your dish into the oven.
6. Select operation mode and temperature. The oven timer automatically calculates the startup time for cooking by using the end of cooking time and the cooking period you have set. The selected operation mode is activated when the startup time of cooking has come on and the oven is heated up to the set temperature. The oven maintains this temperature until the end of cooking time.

7. After the cooking process is completed, "End" appears on the display and the alarm will sound.
8. The alarm signal will sound for 2 minutes. To stop the alarm signal, simply press any key. The alarm will be silenced and the current time will be displayed.

	If the alarm is silenced by pressing any key, the oven will restart operating. If you press any button at the end of the alarm period, the oven will restart operating.
--	---

9. Turn off the oven with the Temperature knob and Function knob.

Using the keylock

Activating the keylock

Prevent the oven from being used by activating the Keylock function.

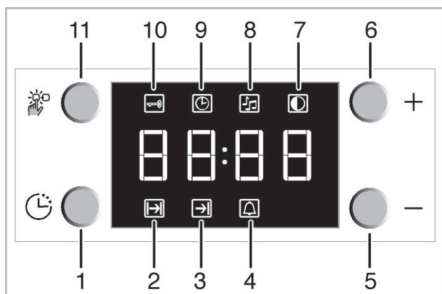

- 1 Program key
- 2 Cooking time
- 3 End of cooking time
- 4 Alarm
- 5 Minus key
- 6 Plus key
- 7 Screen brightness setting
- 8 Alarm volume
- 9 Current time
- 10 Keylock
- 11 Adjustment key

1. Press the key (11) to activate Keylock symbol (10).

"OFF" will appear on the display.

2. Press '+' key (6) to activate the keylock.

Once the keylock is activated, "On" appears on the display and the Keylock symbol (10) remains lit.



When the Keylock function is activated, the control panel buttons, excepting for the key (11), cannot be used.

Deactivating the keylock

1. Press the adjustment key (11) to activate the keylock symbol (10).

The "On" will appear on the display.

2. Press '-' (5) to deactivate the keylock.

The "OFF" will be displayed once the keylock is deactivated.

Using the clock as an alarm

You can use the clock of the appliance for any warning or reminder apart from the cooking programme.

The alarm clock has no influence on the functions of the oven. It is only used as a warning. For example, this is useful when you want to turn food in the oven at a certain point in time. The alarm clock will give a signal once the time you set is over.

Setting the alarm clock

1. Press the program key (1) to activate the alarm time symbol (4).



The maximum alarm time that can be set is 23 hours and 59 minutes

2. Adjust the alarm time using '-' or '+' (5/6) keys.

Alarm symbol will remain lit and the alarm time will appear on the display once the alarm time is set.

3. At the end of the alarm time, Alarm Time symbol (4) will start flashing and the alarm signal is heard.

Turning off the alarm

1. To stop the alarm, just press any key.

The alarm will be silenced and current time will be displayed.

If you want to cancel the alarm:

1. To reset the alarm time, press the program key (1) to activate the alarm time symbol (4).

2. Press and hold the '-' (5) key until "00:00" is displayed.



The alarm time will be displayed. If the alarm time and cooking time are set concurrently, the shortest time will be displayed.

Changing alarm tone

1. Press Setting key (11) to activate the Alarm Tone symbol (8).

2. Adjust the desired tone using '-' or '+' (5/6) keys.

» Selected alarm tone will appear as "b-01", "b-02" or "b-03" on the display.

Cooking times table

Cooking time table



The values indicated in the table overleaf are data indicative. They may vary according to the type of food as well as your cooking preferences.

Dish	Cooking level number	Mode	Rack position	Temperature (°C)	Cooking time (approx. in min.)
**Cakes in tray	One level		2-3	175	25 ... 35
**Cakes in mould	One level		2-3	180	40 ... 50
**Cakes in cooking paper	One level		2-3	175	25 ... 35
	2 levels		1-4	175	30 ... 45
**Sponge cake	One level		2-3	200	10 ... 15
	2 levels		1-4	175	20 ... 35
**Cookie	One level		2-3	175	25 ... 35
	2 levels		1-4	170 ... 190	30 ... 45
**Dough pastry	One level		2-3	200	30 ... 45
**Rich pastry	One level		2-3	200	30 ... 40
	2 levels		1-4	200	40 ... 50
**Leaven	One level		2-3	200	35 ... 50
**Lasagna	One level		2-3	200	30 ... 45
**Pizza (thick)	One level		2-3	200 ... 220	15 ... 20
**Pizza (thin)	One level		2-3	200	10 ... 15
Beef steak (whole) / Roast	One level		2-3	25 min. 250/max, then 180 ... 190	100 ... 120
Leg of Lamb (casserole)	One level		2-3	25 min. 250/max, then 190	70 ... 90
Roasted chicken	One level		2-3	15 min. 250/max, then 180 ... 190	55 ... 65
Turkey (5.5 kg)	One level		1	25 min. 250/max, then 180 ... 190	150 ... 210
Fish	One level		2-3	200	20 ... 30

When cooking with 2 trays at the same time, place the deeper tray on the upper rack and the other one on the lower rack.

Baking and roasting

	Level 1 is the bottom level in the oven.
--	--

How to operate the grill

	Before using the oven the clock time must be set. If the clock time is not set, the main oven will not work.
	Close oven door during grilling. Hot surfaces may cause burns!
	Do not use the upper level for grilling

Switching on the grill

1. Turn the Function knob to the desired grill symbol.
2. Select the desired grilling temperature.
3. If required, perform a preheating of about 5 minutes.

The temperature light turns on.

Switching off the grill

1. Turn the Function knob to the off (top) position.

	Food which is unsuitable for grilling may catch fire! Only use food suitable for intensive grilling heat. Do not place the food too far back on the grill. This is the hottest area and fatty food may catch fire
--	---

Cooking time table for grilling
Grilling with electric grill

Food	Insertion level	Grilling time (approx.)
Fish	3...4	20...25 min. #
Sliced chicken	3...4	15...20 min.
Lamb chops	3...4	12...15 min.
Roast beef	3...4	15...25 min. #
Veal chops	3...4	15...25 min. #
# depending on thickness		



7 Maintenance and care

General information

The service life of the appliance will extend and the possibility of problems will decrease if the appliance is cleaned at regular intervals.

Service intervals

- Every twelve months the appliance should be serviced by a Defy Service agent to ensure continued efficient and safe operation.
- Note: If required, the cleaning of the valves should only be carried out by a qualified Defy technician. i.e. Burner not functioning correctly.
- Removable burner parts should be washed weekly with hot water and detergent.
- Take care to remove any encrustations and ensure that the burner holes are clear.
- The condition of the gas hose and valve should be inspected for leaks every time the gas bottle is re-filled.

	DANGER Risk of electric shock! Switch off the electricity before cleaning the appliance to avoid an electric shock.
	
	DANGER Hot surfaces may cause burns! Allow the appliance to cool down before you clean it.

- Clean the appliance thoroughly after each use. In this way it will be possible to remove cooking residues more easily, thus avoiding these from burning the next time the appliance is used.
- No special cleaning agents are required for cleaning the appliance. Use warm water with washing liquid, a soft cloth or sponge to clean the product and wipe it with a dry cloth.
- Always ensure any excess liquid is thoroughly wiped off after cleaning and any spillage is immediately wiped dry.
- Never use high-pressure steam equipment or a water jet for cleaning.
- Do not use cleaning agents that contain acid or chloride to clean the stainless or inox surfaces and the handle.

- Use a soft cloth with a liquid detergent (not abrasive) to wipe those parts clean, paying attention to sweep in one direction.
- Never use cleaning products containing abrasive materials as these could damage the decorative and informative paint applications.
- Remove the burners and wipe them with a thin damp cloth or a non-abrasive sponge. Use a neutral detergent. Dry afterward with a soft cloth and blow away any residual water in the gas outlet holes.



The surface may be damaged by some detergents or cleaning materials. Do not use aggressive detergents, cleaning powder/cream or any sharp objects.



Do not use steam cleaners for cleaning.

Cleaning the hob Gas hobs

1. Remove and clean the saucepan carriers and burner caps.
2. Clean the hob.
3. Install the burner caps and make sure that they are seated correctly.
4. When installing the upper grills, pay attention to place the saucepan carriers so that the burners are centered.

Cleaning the control panel

Clean the control panel and knobs with a damp cloth and wipe them dry.



Damage of the control panel!
Do not remove the control knobs for control panel cleaning.

Cleaning the oven / oven door

To clean the oven door, use warm water with washing liquid, a soft cloth or sponge to clean the appliance and wipe it with a dry cloth.



Don't use any harsh abrasive cleaners or sharp metal scrapers for cleaning the oven door. They could scratch the surface and destroy the glass

Removing the oven door

1. Open the front door (1).
2. Open the clips at the hinge housing (2) on the right and left hand sides of the front door by pressing them down as illustrated in the figure.

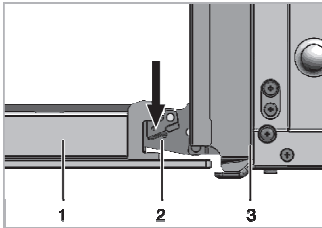

- 1 Front door
- 2 Hinge
- 3 Oven

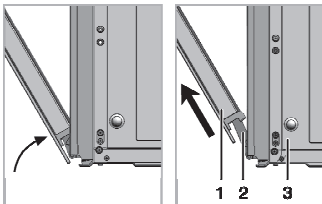

3. Move the front door to half-way.
4. Remove the front door by pulling it upwards to release it from the right and left hinges.

	Repeat removal steps in reverse order to refit the door. Do not forget to close the clips at the hinge housing when refitting the door.
--	---

Removing the door inner glass

The oven door inner glass panel can be removed for cleaning.

Open the oven door.

Remove the metal part (1) by removing three screws that secure it.

To remove the plastic holders (2), use a flat screwdriver, to free the fixing foot (5).

Push the fixing foot through the opening (6) in the direction of the arrow .

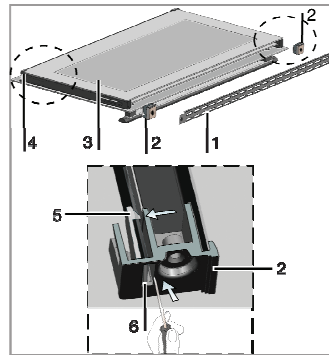

- 1 Metal part
- 2 Plastic carrier
- 3 Inner glass panel
- 4 Lower plastic slot
- 5 Fixing foot
- 6 Window

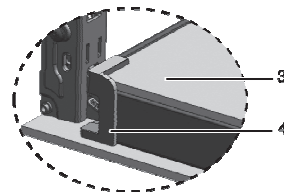

Pull the inner glass panel (3) towards yourself until it detaches from its slots (4). When refitting the glass panel, make sure that it is seated into the plastic slots.

Replacing the oven lamp

	DANGER Hot surfaces may cause burns! Make sure that the appliance is switched off and cooled down to avoid the risk of an electrical shock.
	The oven lamp is a special electric light bulb that can stand up to 300 °C. See Technical specifications for details. Oven lamps can be obtained from Authorised Service Agents.
	Position of lamp might vary from the figure.

If your oven is equipped with a round lamp:

1. Disconnect the product from the mains.
2. Turn the glass cover counter clockwise to remove it.

3. Refit the glass cover.

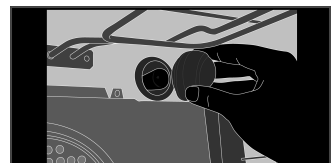

Gas Jet Cleaning Procedure

- Every six months the gas jets on your hob should be cleaned to ensure continued efficient and safe operation.
- This may be done using a Gas Jet Cleaning Kit which may be purchased from your nearest Defy Service Centre.
- The kit comprises of a sliding T-bar (A) a socket (B) and a 'Classic pin' (C).
- **Fit the T-bar to the socket and remove the pot stands, burner caps and burner bodies.**

1. Insert the socket into the central tube of the burner so that it locates over the brass gas jet at the bottom of the tube.

2. Gently loosen the brass gas jet by turning the socket in an anti-clockwise direction.

3. Carefully lift the socket and loosened brass gas jet from the central burner tube.

4. Insert the Classic pin into central hole of the jet and slide it up and down until the jet is free of accumulated dirt.

5. Re-assemble in reverse order.

6. Clean all the burner jets in the manner described above.

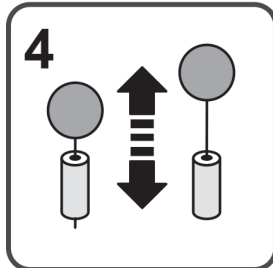
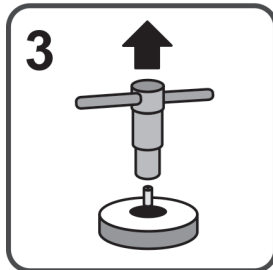
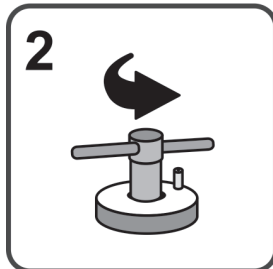
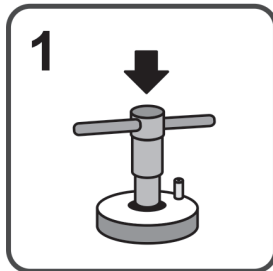
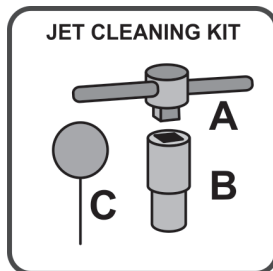

8 Troubleshooting

Problem solving guide—before calling for technical support

Oven emits steam when it is in use:	
<i>It is normal that steam escapes during operation. This is not a fault.</i>	
Water drops occur during cooking:	
<i>Steam that arises during cooking can condense and form water droplets when it comes into contact with cold surfaces of the appliance. This is not a fault.</i>	
Product does not operate:	
The mains fuse is defective or has tripped.	<i>Check fuses in the fuse box. If necessary, replace or reset them.</i>
The appliance is not plugged into the (grounded) socket.	<i>Check the plug connection.</i>
Buttons/knobs/keys on the control panel do not function.	<i>Keylock may be enabled. Please disable it. (See Using the keylock, page 23)</i>
Oven light does not work:	
Oven lamp is defective.	<i>Replace the oven lamp.</i>
Power is cut.	<i>Check if there is power. Check the fuses in the fuse box. If necessary, replace or reset the fuses.</i>
Oven does not heat:	
Function and/or Temperature are not set.	<i>Set the function and the temperature with the Function and/or Temperature knob/key.</i>
In models equipped with a timer, the timer is not adjusted. (In models with a microwave oven, the timer only controls the microwave oven.)	<i>Adjust the timer.</i>
Power is cut.	<i>Check if there is power. Check the fuses in the fuse box. If necessary, replace or reset the fuses.</i>
There is no gas:	
Main gas valve is closed.	<i>Open the gas valve.</i>
Gas pipe is bent.	<i>Ensure the gas pipe has been properly fitted.</i>
There is no ignition spark:	
No current.	<i>Check fuses in the fuse box.</i>
Timer is not set.	<i>Set the timer.</i>
Burners are not burning properly or at all:	
Burners are dirty.	<i>Clean burner components.</i>
Burners are wet.	<i>Dry the burner components.</i>
Burner cap is not mounted safely.	<i>Mount the burner cap properly.</i>
Gas valve is closed.	<i>Open gas valve.</i>
Gas cylinder is empty (when using LPG).	<i>Replace the gas cylinder.</i>
The burners will not light:	
The gas pipe is twisted, bent or kinked.	<i>Ensure the gas pipe has been properly fitted.</i>
The burners are dirty or wet.	<i>Clean / dry the burner components.</i>
The gas cylinder is empty.	<i>Replace the gas cylinder.</i>
The burner caps are not fitted correctly.	<i>Fit the burner caps correctly.</i>
The gas pressure regulator is closed.	<i>Check to see if the regulator is open.</i>
The lighting procedure has not been followed correctly.	<i>Follow the correct lighting procedure.</i>

The flame is yellow, pots and pans are stained:	
The burners are dirty or wet.	<i>Clean / dry the burner components.</i>
The gas is running out.	<i>Replace the gas cylinder.</i>
The burner caps are not fitted properly.	<i>Fit the burner caps properly.</i>
The gas pipe is twisted, bent or kinked.	<i>Ensure the gas pipe has been properly fitted.</i>
Smell of leaking gas:	
Are all the control knobs in the off position?	<i>Check to see the knobs are in the off position.</i>
The gas pipe is fitted incorrectly.	<i>Ensure the gas pipe has been properly fitted.</i>
The hose clamps require tightening or replacing.	<i>Have hose clamps tightened or replaced.</i>
The regulator is faulty and needs to be replaced.	<i>Have regulator checked and replaced.</i>
	If the problem cannot be remedied after following the troubleshooting problem solving guide, please consult with an authorised service agent or the dealer where you purchased the appliance. Never attempt to repair a defective appliance yourself.

9 Service Centres

Other areas are serviced by over 200 authorised agents. For further details please consult the nearest regional Defy Technical Support centre.

BLOEMFONTEIN 160 Long Street, Hilton,
Bloemfontein 9301.
Tel. 051 400 3900
Bloemfontein.Service@defy.co.za

CAPE TOWN 5A Marconi Rd.
Montague Gardens, 7441.
Tel. 021 528 3000
CapeTown.Service@defy.co.za

DURBAN 35 Intersite Avenue,
Umgeni Business Park, Durban 4051.
Tel. 031 268 3300
Durban.Service@defy.co.za

EAST LONDON 16 Bowls Rd. Arcadia,
East London 5201.
Tel. 043 743 7100
EastLondon.Service@defy.co.za

JOHANNESBURG Cnr. Mimetes & Kruger Sts. Denver ext.12
Commercial Head Office,
Administration, Distribution, National Groups, Tel. Johannesburg. 2094.
Sales, Contracts and Credit. Tel. 011 621 0200 or 011 621 0300
Gauteng.Service@defy.co.za

POLOKWANE 87 Nelson Mandela Drive.
Superbia 0699.
Tel. 0152 92 1166 / 7 / 8 / 9.
Polokwane.Service@defy.co.za

PORT ELIZABETH 112 Patterson Road,
North End, Port Elizabeth 6001.
Tel. 041 401 6400
PortElizabeth.Service@defy.co.za

PRETORIA. Block A1 Old Mutual Industrial Park.
Cnr. D.F.Malan Drive & Moot Str.
Hermanstad. 0082.
Tel. 012 377 8300
Pretoria.Service@defy.co.za

10 Warranty

This certificate is issued by DEFY APPLIANCES (PTY) LTD manufacturers of Defy and Ocean products, hereinafter the Company, to the original purchaser only, of the appliance described on the certificate and shall constitute the only warranty given in respect of this appliance.

The Company warrants to the original purchaser that for a period of TWO YEARS from date of purchase the appliance is free from defect under normal domestic use, both in workmanship and material, subject to the following conditions.

1. Repair or replacement of any part of this appliance, found by the Company to be defective, shall be at the election of the Company. The Company reserves the right to effect such service through any of its Service Divisions or Authorised Service Dealers. The cost of such service shall be borne by the Company in full, provided that the appliance is located no further than 50 km from a Company Service Centre or an Authorised Service Dealer. Where the appliance is located beyond the 50 km radius, the purchaser shall be liable for the standard travelling charges, as determined by the Company.
CARRY IN SERVICE Microwave ovens, Compact cookers and small appliances are repaired in our service centres and are not collected from the customers home. Faulty units should be delivered to the purchasing dealer or to the nearest Company Service Centre for warranty repairs.
2. Rusted or corroded plates, vitreous enamelware, fuses and lamps are specifically excluded from these warranties. It is an express condition of these warranties that the purchaser takes due care and attention in the use and maintenance of the appliance. Abuse, misuse in conflict with operating instructions, connection to incorrect voltages and subjection to commercial use shall release the Company from its obligations.
3. This warranty shall become void and cease to operate if the appliance is dismantled by, or any repairs to the appliance are effected by any persons not duly authorised by the Company, or if substitute parts not approved by the Company are used in the appliance, or if the serial number of the appliance is removed.
4. The Company shall not be responsible for damages resulting from fire, flood, civil disturbances or any Act of God. The Company shall not, in terms of these warranties be responsible nor held liable for any consequential loss or damage of any kind caused by or due to the failure or malfunction of the appliance.
5. The Company shall not be responsible for transportation or other costs other than those incurred within the provisions of Point 1 of this Certificate.
6. These warranties shall not apply to the appliance if it is purchased or used beyond the borders of the Republic of South Africa, Namibia, Botswana, Swaziland and Lesotho.
7. Where service is requested under warranty and no fault or defect can be found by the Company, all costs incurred will be for the purchaser's account.
8. This Certificate as well as your invoice will serve as proof of purchase. For the purpose of warranty, it will be essential to produce this Certificate and invoice. Failure to do so, will render the purchaser liable for service costs.

KEEP THIS CERTIFICATE AND SALES INVOICE AS PROOF OF PURCHASE FOR WARRANTY PURPOSES.

11 Installers Details

Installer's details to be recorded below

INSTALLER'S NAME AND COMPANY.....

.....

INSTALLER'S REGISTRATION NUMBER.....

.....

HAVE YOU RECEIVED A WRITTEN COMPLETION CERTIFICATE?.....

.....

HAS THE INSTALLER EXPLAINED THE OPERATIONAL DETAILS OF YOUR STOVE TO YOU?.....



DGS162

You can rely on Defy. To simplify.

Please register your product at
www.defy.co.za

Free Manuals Download Website

<http://myh66.com>

<http://usermanuals.us>

<http://www.somanuals.com>

<http://www.4manuals.cc>

<http://www.manual-lib.com>

<http://www.404manual.com>

<http://www.luxmanual.com>

<http://aubethermostatmanual.com>

Golf course search by state

<http://golfingnear.com>

Email search by domain

<http://emailbydomain.com>

Auto manuals search

<http://auto.somanuals.com>

TV manuals search

<http://tv.somanuals.com>