



DAW369
DAW370

You can rely on Defy. To simplify.

Washing Machine

Users Manual

Record in the space below the listed information for future reference. The serial number is on the serial label located on the inside of the door of the washing machine.

SERIAL NUMBER.....

DATE OF PURCHASE.....

PURCHASED FROM.....

.....

The manufacturer strives for continuous improvement. For this reason, the text and illustrations in this manual are subject to change without notice.

1 Introduction

Dear customer,

Your new Defy washing machine was manufactured in a state of the art facility and has passed the strictest quality control procedures.

Please read this manual carefully before using your washing machine for the first time and then store it within easy reach for future reference.

This manual will provide you with information on how to operate and care for your washing machine to gain the maximum benefit from it.

We trust you will enjoy years of trouble free use.

EXPLANATION OF SYMBOLS

 Important information

 Warning—Hazardous situations

 Warning—Electric shock

PLEASE REGISTER YOUR PRODUCT AT

www.defy.co.za

DEFY APPLIANCES (PTY) LTD

P.O.BOX 12004

JACOBS

DURBAN

4026

SOUTH AFRICA



2 Important safety instructions

2.1 General safety

- This washing machine is not intended for use by persons (including children) with reduced physical, sensory or mental capabilities or lack of experience and knowledge unless they have been given supervision or instruction concerning the use of the washing machine by a person responsible for their safety. Children should be supervised to ensure that they do not play with the washing machine.
- Never place the washing machine on a carpeted floor. Lack of airflow beneath the washing machine could cause overheating.
- In case of malfunction or maintenance work, disconnect the washing machine from the electrical mains immediately. Repairs must only be made by a qualified technician.
- This washing machine is designed to resume operating by powering on after a power interruption. If you wish to cancel the programme, see "Cancelling the programme" section.
- The washing machine must be earthed and the manufacturer and seller do not accept responsibility for any damage due to incorrect electrical connection.
- The washing machine should be plugged into a 16 Amp, 230 Volt 50 Hz earthed 3 pin wall socket.
- For safety reasons, the wall socket and the plug should be accessible after installation. If the power cord should ever need replacing, use only a genuine cord available from the nearest Defy Service Centre. Repairs should only be made by a qualified technician.
- The water supply and draining hoses must be securely fastened and remain undamaged to prevent water leakage.
- Never open the loading door or remove the filter while there is still water in the drum as there is a risk of flooding and injury from hot water.
- Do not force open the locked loading door. The loading door will be ready to open a few minutes after the washing cycle ends. The lock mechanism may be damaged if force is used to open the loading door.
- Unplug the product when not in use.
- Never wash the product by spreading or pouring water onto it! There is the risk of an electric shock!

- Never touch the plug with wet hands! Never unplug by pulling on the cable, always pull out by grabbing the plug.
- Use detergents, softeners and supplements suitable for automatic washing machines only.
- Follow the instructions on the textile tags and on the detergent package.
- The product must be unplugged during installation, maintenance, cleaning and repairing procedures.
- Always have the installation and repairing procedures carried out by the Authorized Service Agent. The Manufacturer shall not be held liable for damages that may arise from procedures carried out by unauthorized persons.
- If the power cable is damaged, it must be replaced by the manufacturer, after sales service or a similarly qualified person.

2.2 Intended use

- The washing machine must only be used domestically and for the purposes for which it was designed.

2.3 Children's safety

- Electrical products are dangerous for children. Keep children away from the washing machine when it is in use. Use child lock to prevent children from tampering with the washing machine controls.
- Close the loading door when leaving the room where the product is located.
- Store all detergents and additives in a safe place away from the reach of the children by closing the cover of the detergent container or sealing the detergent package.

2.4 Package information





- Please ensure that packaging material is disposed of in a responsible manner. Plastic bags should be cut up to prevent children playing with them and accidentally suffocating.

2.5 Disposing of the washing machine

- This product has been manufactured with high quality parts and materials which can be reused and are suitable for recycling. Do not dispose of the product with normal domestic waste at the end of its service life. Please consult your local authorities. Should you at any time in the future scrap the washing machine, cut the power cord and take measures to render the door lock inoperative thereby preventing children, when playing, getting trapped inside.

3 Installation

Refer to the nearest Authorised Service Agent for installation of the machine. Review the information in the user manual and ensure that the electricity, water supply and water drainage systems are appropriate before calling an Authorized Service Agent. If they are not, call a qualified technician and plumber to have any necessary arrangements carried out.

	Preparation of location, electrical, tap water and waste water installations of the machine are the customer's responsibility.
	Warning: Installation and electrical connections of the machine must be carried out by an Authorized Service Agent. The Manufacturer shall not be held liable for damages that may arise.
	Warning: Prior to installation, visually check if the machine has any defects on it. If so, do not have it installed. A damaged machine is a safety risk.
	Ensure that the water inlet and discharge hoses as well as the power cable are not folded, pinched or crushed, during or after installation or cleaning procedures.

3.1 Appropriate installation location



- Place the machine on a rigid floor that has sufficient load carrying capacity. Do not place it on a long pile rug or similar surfaces.
- Do not place machine on the power cable.
- Do not install the product at places where the temperature may fall below 0°C.
- Place the product at least 10 mm away from the edges of other furniture.

3.2 Removing packaging reinforcement

Tilt the machine backwards. Remove the packaging reinforcement by pulling on the ribbon.







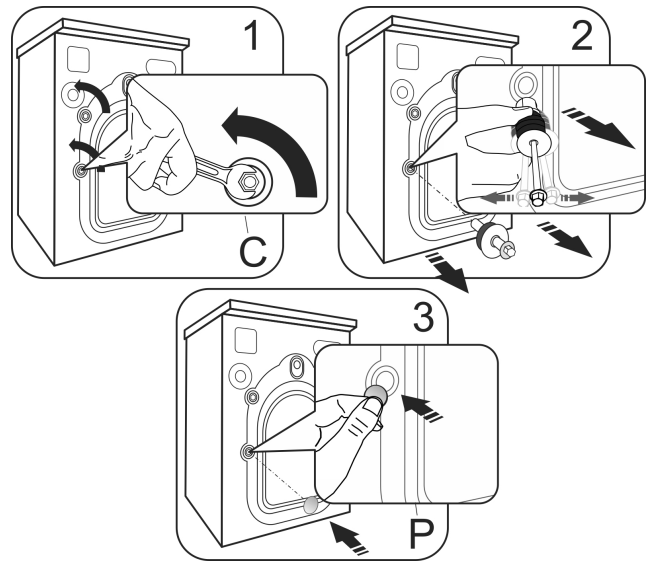

3.3 Removing the transportation locks

	Warning: Do not remove the transportation locks before taking out the packaging reinforcement.
	Warning: Remove the transportation safety bolts before operating the washing machine to avoid damaging the machine.

1. Loosen all the bolts with a suitable spanner until they rotate freely (C).
2. Remove transportation safety bolts by turning them gently.
3. Attach the plastic covers supplied in the User Manual bag into the holes on the rear panel. (P)



	Keep the transportation safety bolts in a safe place to reuse when the washing machine needs to be moved again in the future.
	Never move the product without the transportation safety bolts securely in place!

	The water supply pressure required to run the machine is between 1 - 10 bars (0.1 – 1 MPa). It is necessary to have 10 – 80 litres of water flowing from a fully open tap per minute to have your machine run smoothly. Attach a pressure reducing valve if water pressure is higher.
	If only the single (cold) water-inlet and not the hot water inlet is going to be used, the supplied stopper must be installed to the hot water valve before operating the machine. (Only applies to machines supplied with a blind stopper).
	Warning: Models with a single water inlet should not be connected to the hot water tap. In such a case the laundry will be damaged or the machine will switch to protection mode and will not operate.
	Warning: Do not use old or used water inlet hoses on the new product. It may cause stains on your laundry.

3.4 Connecting the water supply

1. Connect the special hoses supplied with the product to the water inlets on the product. Red hose (left) (max. 90 °C) is for hot water inlet, blue hose (right) (max. 25 °C) is for cold water inlet.

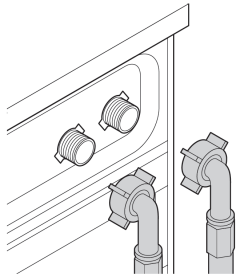

	Warning: Ensure that the cold and hot water connections are made correctly when installing the product, to prevent your laundry from coming out hot at the end of the washing process resulting in undue wear.
--	---

2. Tighten all hose nuts by hand. Never use a tool when tightening the nuts.

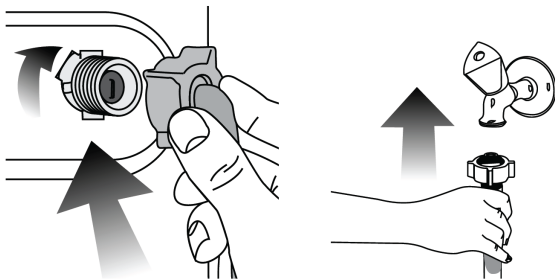

3. Open the taps completely after finishing the hose connection and check for water leaks. If there are any leaks, turn off the tap and remove the nut. Retighten the nut carefully after checking the seal. To prevent water leakages and damages caused by them, keep the taps closed when the machine is not in use.

3.5 Connecting to the drain

•The end of the drain hose must be directly connected to the wastewater drain or to the washbasin.

	Warning: Ensure that the end of the discharge hose is securely fixed into its housing to ensure the smooth flow of water and to avoid any risk of flooding and injury from hot water.
--	--

The hose should be attached to a height of at least 40 cm, and 100 cm at the most.

• Incorrect hose height results in water discharge from the machine being more difficult and the laundry may come out excessively wet.

Ensure that the heights in the figure are followed.

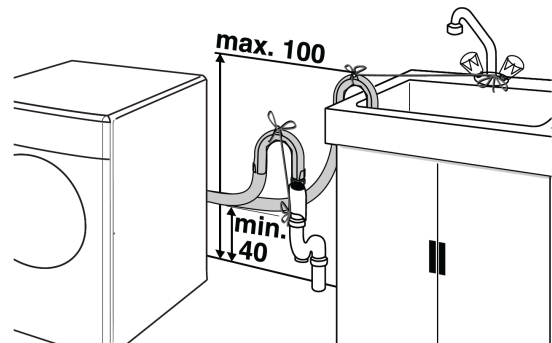

To prevent flowing of dirty water back into the machine and to allow for easy discharge, do not immerse the hose end into dirty water and do not insert it more than 15 cm into the drain. If it is too long, carefully cut it shorter.

- The hose should not be twisted, bent or squeezed shut and must not be stepped on.
- If the length of the hose is too short, add an original extension hose. The length of the hose may not be longer than 3.2 m. To avoid water leaks, the connection between the extension hose and the drain hose of the product must be securely fitted with an appropriate clamp.

3.6 Adjusting the feet

	Warning: To ensure that the machine operates efficiently and vibration-free, it must be level on its feet. Level the machine by adjusting the feet. Failure to level and balance the machine may result in machine movement and vibration problems.
--	--

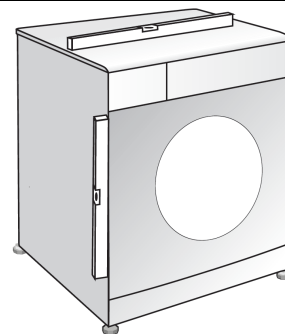

1. Loosen the lock nuts on the feet by hand.
2. Adjust the feet until the machine stands level and balanced.
3. Tighten all lock nuts again by hand.

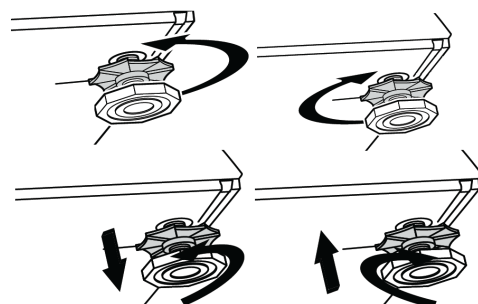



Warning: To prevent the lock nuts from being damaged, do not use tools to loosen them.

3.7 Electrical connection

- The washing machine must be earthed and the manufacturer and seller do not accept responsibility for any damage due to incorrect electrical connection.
- Connection must comply with national regulations.
- Power cable plug must be within easy reach after installation.
- The washing machine should be plugged into a 16 Amp, 230 Volt 50 Hz earthed 3 pin wall socket.
- If the current value of the fuse or breaker in the house is less than 16 Amps, have a qualified electrician install a 16 Amp fuse.
- The voltage specified in the "Technical specifications" section must be equal to your mains voltage.
- Do not make connections via extension cables or multi-plugs.



Warning: Damaged power cables must be replaced by an Authorized Service Agent.

Transportation of the product

1. Unplug the product before transporting it.
2. Remove water drain and water supply connections.
3. Drain all water that has remained in the product.
4. Install transportation safety bolts in the reverse order of removal procedure.



Never move the product without the transportation safety bolts properly fixed in place!



Warning: Packaging materials are dangerous to children. Keep packaging materials in a safe place away from reach of the children.

4 Preparation

4.1 Sorting the laundry

- Sort laundry according to type of fabric, colour, and degree of soiling and allowable water temperature.
- Always obey the instructions given on the garment tags.

4.2 Preparing laundry for washing

- Laundry items with metal attachments such as, underwired bras, belt buckles or metal buttons will damage the machine.

Remove the metal pieces or wash the clothes by putting them in a laundry bag or pillow case.

- Remove all items in pockets such as coins, pens and paper clips, and turn pockets inside out and brush pockets. Such objects may damage the machine and cause noise.
 - Put small size clothes such as infant's socks and nylon stockings in a laundry bag or pillow case.
 - Place curtains in without compressing them. Remove curtain attachment items.
 - Fasten zippers, sew loose buttons and mend rips and tears.
 - Wash "machine washable" or "hand washable" labelled products with an appropriate programme only.
 - Do not wash colours and whites together. New, dark coloured cottons release a lot of dye. Wash them separately.
 - Tough stains must be treated properly before washing. If unsure, check with a dry cleaner.
 - Use only dyes/colour changers and limescale removers suitable for machine wash. Always follow package instructions.
 - Wash trousers and delicate laundry turned inside out.
 - Keep laundry items made of Angora wool in the freezer for a few hours before washing. This will reduce pilling.
 - Laundry that has been soiled with flour, lime dust, milk powder, etc. must be shaken off before placing into the machine. Dusts and powders on the laundry may build up on the inner parts of the machine in time and can cause damage.
- ### 4.3 Things to be done for energy saving
- Operate the machine in the highest capacity allowed by the programme you have selected, but do not overload; see "Programme and consumption table" (5.10).
 - Always follow the instructions on the detergent packaging.
 - Wash slightly soiled laundry at low temperatures.
 - Use faster programmes for small quantities of lightly soiled laundry.
 - Do not use prewash and high temperatures for laundry that is not heavily soiled or stained.
 - If you plan to dry laundry in a dryer, select the highest spin speed recommended during the washing process.
 - Do not use detergent in excess of the amount recommended on the detergent package.

4.4 Initial use

Before first use of the machine, ensure that all preparations are made in accordance with the instructions in sections “Important safety instructions” and “Installation”.

To prepare the machine for washing laundry for the first time, run the Drum Cleaning programme. If your product is not equipped with the Drum Cleaning programme, perform the Initial Use procedure in accordance with the methods described under “6.2 Cleaning the loading door and the drum” section of the user manual.

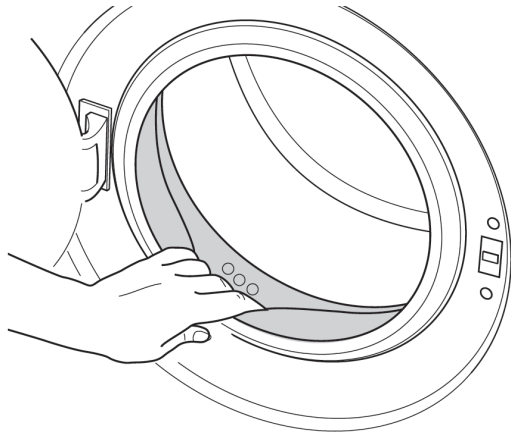

i Use an anti-limescale suitable for washing machines.

i Some water might have remained in the machine due to the quality control processes in the production. It is not harmful for the product.

4.5 Correct load capacity

The maximum load capacity depends on the type of laundry, the degree of soiling and the washing programme desired.

The machine automatically adjusts the amount of water according to the weight of the loaded laundry.

! **Warning:** Follow the information in the “Programme and consumption table”. When overloaded, the machine’s washing performance will drop. Moreover, noise and vibration problems may occur.

4.6 Loading the laundry

1. Open the loading door.
2. Place laundry items loosely into the machine.
3. Push the loading door to close until you hear a locking sound. Ensure that no items are caught in the door.

i The loading door is locked while a programme is running. The door can only be opened a while after the programme comes to an end.

! **Warning:** If loading of the laundry has been incorrectly done, noise and vibration problems may occur in the machine.

Laundry type	Weight (g)
Dressing gown	1200
Serviette	100
Duvet cover	700
Bed Sheet	500
Pillowcase	200
Tablecloth	250
Towel	200
Hand towel	100
Evening gown	200
Underwear	100
Men’s overalls	600
Men’s shirt	200
Men’s pyjamas	500
Blouses	100

4.7 Using detergent and softener

i When using detergent, softener, starch, fabric dye, bleach or limescale remover read the manufacturer’s instructions on the package carefully and follow the dosage values. Use a measuring cup if available.

Detergent Drawer

The detergent drawer is composed of three compartments:

- (1) For prewash
 - (2) For main wash
 - (3) For softener
- (*) in addition, there is a siphon piece in the softener compartment.

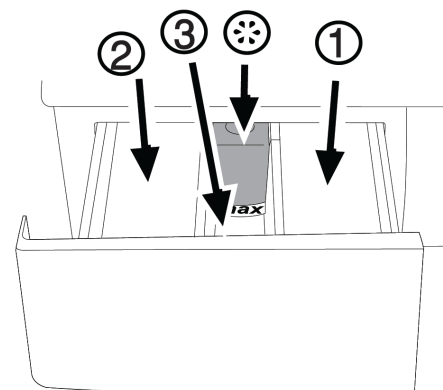

Detergent, softener and other cleaning agents

- Add detergent and softener before starting the washing programme.
- Never leave the detergent drawer open while the washing programme is running.
- When using a programme without prewash, do not put any detergent into the prewash compartment (compartment no. "1").
- In a programme with prewash, do not put liquid detergent into the prewash compartment (compartment no. "1").
- Do not select a programme with prewash if you are using a detergent bag or dispensing ball. Place the detergent bag or the dispensing ball directly among the laundry in the machine.
- If you are using liquid detergent, do not forget to place the liquid detergent cup into the main wash compartment (compartment no. "2").

Choosing the detergent type

The type of detergent to be used depends on the type and colour of the fabric.

- Use different detergents for coloured and white laundry.
- Wash your delicate clothes with special detergents only (liquid detergent, wool shampoo, etc.) used solely for delicate clothes.
- When washing dark coloured clothes and quilts, it is recommended to use a liquid detergent.
- Wash woollens with special detergent made specifically for woollens.



Warning: Use only detergents manufactured specifically for washing machines.

Adjusting detergent amount

The amount of washing detergent to be used depends on the amount of laundry, the degree of soiling and water hardness.

- Do not use amounts exceeding the dosage quantities recommended on the detergent package to avoid problems of excessive foam and poor rinsing. Using the correct amount will also save you money and help the environment.
- Use less detergent for small amounts or lightly soiled clothes.

Using softeners

Pour the softener into the softener compartment of the detergent drawer.

- Do not exceed the (>max<) level marking in the softener compartment.
- If the softener has lost its "fluidity", dilute it with water before pouring it into the detergent drawer.

Using liquid detergents

If the machine has a liquid detergent cup:

- Make sure that you have placed the liquid detergent cup in compartment no. "2".
- If the liquid detergent has lost its "fluidity", dilute it with water before pouring it in the detergent cup.

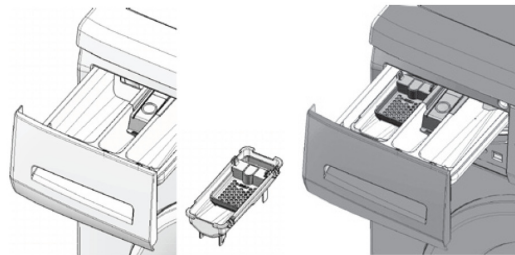

If the product does not have a liquid detergent cup

- Do not use liquid detergent for prewashing in a programme with prewash.
- Liquid detergent stains clothes when used with the Delayed Start function. If you are going to use the Delayed Start function, do not use liquid detergent.

Using gel and tablet detergent

Apply the following instructions when using tablet, gel and similar detergents.

- If the gel detergent thickness is fluidal and your machine does not have a dedicated liquid detergent cup, pour the gel detergent into the main wash detergent compartment during the first water intake. If your machine has a liquid detergent cup, pour the detergent into the cup before starting the programme.
- If the gel detergent thickness is not fluidal or it is a capsule liquid tablet, place it directly into the drum before washing.
- Place tablet detergents into the main wash compartment (compartment no. "2") or directly into the drum before washing.



Tablet detergents may leave residues in the detergent compartment. If this should occur, place the tablet detergent in amongst the laundry near the lower part of the drum for future washes.



Use the tablet or gel detergent without selecting the prewash function.

Using starch

- Add liquid starch, powder starch or fabric dye into the softener compartment.
- Do not use softener and starch together in a washing cycle.
- Wipe the inside of the machine with a damp and clean cloth after using starch.

Using bleaches

- Select a programme with prewash and add the bleaching agent at the beginning of the prewash. Do not put detergent in the prewash compartment. As an alternative application, select a programme with extra rinse and add the bleaching agent while the machine is taking in water from the detergent compartment during the first rinsing step.
- Do not use bleaching agents and detergents by mixing them.

Use only a little amount (approx. 50 ml) of bleaching agent and rinse the clothes very well to avoid skin irritation. Do not pour the bleaching agent onto the clothes and do not use it for coloured clothes.

- When using oxygen based bleaches, select a programme that washes at a lower temperature.

Oxygen based bleaches can be used together with detergents; however, if its thickness is not the same as the detergents, first put the detergent into compartment no. "2" in the detergent drawer and wait until the detergent is washed away while the machine is taking in water. Add the bleaching agent afterwards from the same compartment while the machine is taking in water.

Using limescale remover

- When required, use limescale removers manufactured specifically for washing machines only.

4.8 Tips for efficient washing

		Clothes			
		Light colours and whites	Colours	Dark colours	Delicates/ Woollens/Silks
		(Recommended temperature range based on soiling level: 40-90°C)	(Recommended temperature range based on soiling level: cold-40°C)	(Recommended temperature range based on soiling level: cold-40°C)	(Recommended temperature range based on soiling level: cold-30°C)
Soiling Level	Heavily Soiled (difficult stains such as grass, coffee, fruits and blood)	It may be necessary to pre-treat the stains or perform prewash. Powder and liquid detergents recommended for whites can be used at dosages recommended for heavily soiled clothes. It is recommended to use powder detergents to clean clay and soil stains and the stains that are sensitive to bleaches.	Powder and liquid detergents recommended for colours can be used at dosages recommended for heavily soiled clothes. It is recommended to use powder detergents to clean clay and soil stains and stains that are sensitive to bleaches. Use detergents without bleach.	Liquid detergents suitable for colours and dark colours can be used at dosages recommended for heavily soiled clothes.	Preferably use liquid detergents produced specifically for delicate clothes. Woollen and silk clothes must be washed with special woollen detergents.
	Normally Soiled (For example, stains caused by body on collars and cuffs)	Powder and liquid detergents recommended for whites can be used at dosages recommended for normally soiled clothes.	Powder and liquid detergents recommended for colours can be used at dosages recommended for normally soiled clothes. Use detergents without bleach.	Liquid detergents suitable for colours and dark colours can be used at dosages recommended for normally soiled clothes.	Preferably use liquid detergents produced specifically for delicate clothes. Woollen and silk clothes must be washed with special woollen detergents.
	Lightly Soiled (No visible stains)	Powder and liquid detergents recommended for whites can be used at dosages recommended for lightly soiled clothes.	Powder and liquid detergents recommended for colours can be used at dosages recommended for lightly soiled clothes. Use detergents without bleach.	Liquid detergents suitable for colours and dark colours can be used at dosages recommended for lightly soiled clothes.	Preferably use liquid detergents produced specifically for delicate clothes. Woollen and silk clothes must be washed with special woollen detergents.

5 Operating the product

5.1 Control panel

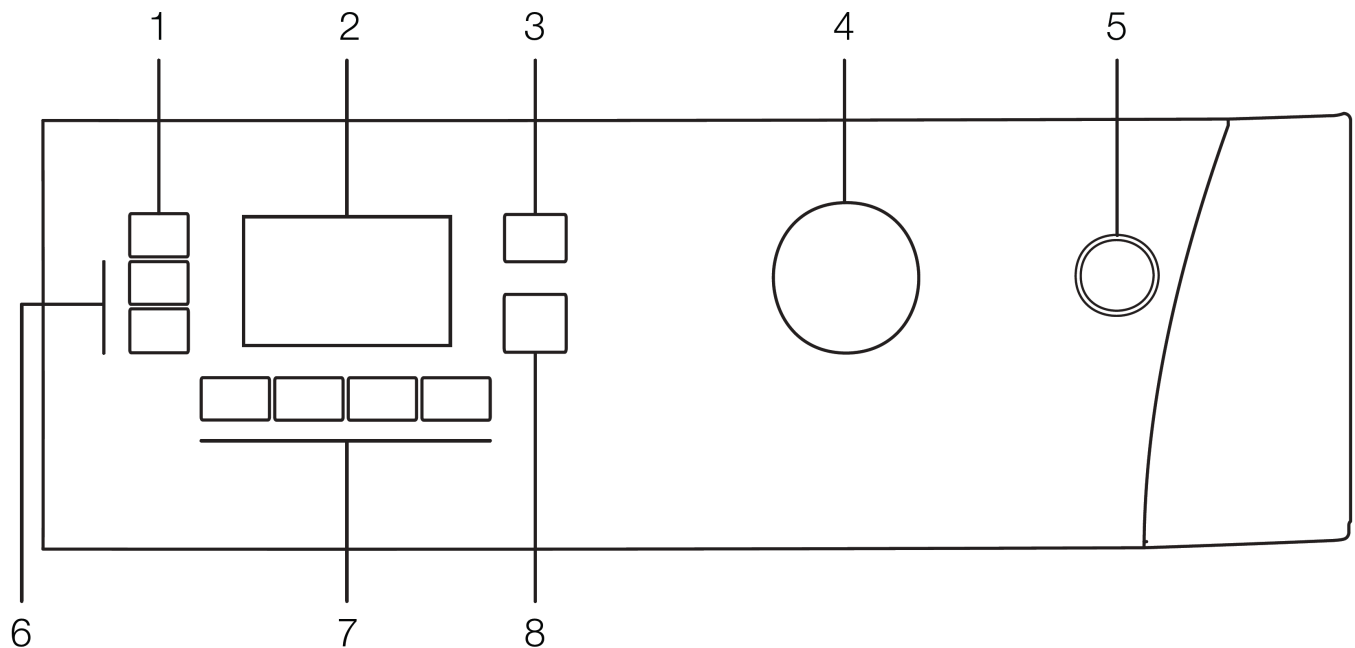

- 1 - Spin Speed Adjustment button
- 2 - Display
- 3 - Temperature Adjustment button
- 4 - Programme Selection knob

- 5 - On / Off button
- 6 - Delayed Start buttons (+ / -)
- 7 - Auxiliary Function buttons
- 8 - Start / Pause / Cancel button

i Figures represented in this instruction manual are schematic and may not correspond exactly with your washing machine. If the parts are not included in the washing machine you have purchased, they may be model specific and therefore only valid for certain models.

5.2 Display symbols

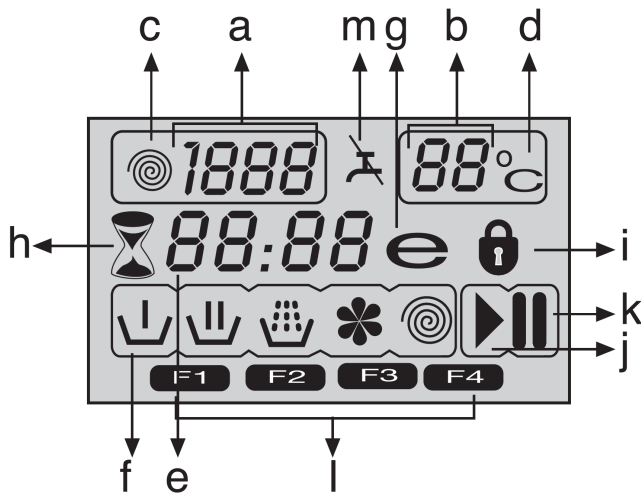

- a - Spin Speed indicator
- b - Temperature indicator
- c - Spin symbol
- d - Temperature symbol
- e - Remaining Time and Delayed Start indicator
- f - Programme Indicator symbols (Prewash / Main Wash / Rinse / Softener / Spin)
- g - Economy symbol
- h - Delayed Start symbol
- i - Door Locked symbol
- j - Start symbol
- k - Pause symbol
- l - Auxiliary Function symbols
- m - No Water symbol

5.3 Preparing the machine

Make sure that the hoses are securely connected. Plug in your machine. Open the tap completely. Place the laundry in the machine. Add detergent and fabric softener.

5.4 Programme selection

Select the programme suitable for the type, quantity and soiling degree of the laundry in accordance with the "Programme and consumption table" (5.10) and the temperature table below.

90°C	Heavily soiled white cottons and linens. (coffee table covers, tablecloths, towels, bed sheets, etc.)
60°C	Normally soiled, coloured, fade proof linens, cottons or synthetic clothes (shirts, dressing gowns, pyjamas, etc.) and lightly soiled white linens (underwear, etc.)
40°C- 30°C- Cold	Mixed laundry including delicate textile (net curtains, etc.), synthetics and wool.

Select the desired programme with the Programme Selection button.

	Programmes are limited according to the highest spin speed appropriate for particular types of fabric.
	When selecting a programme, always consider the type of fabric, colour, degree of soiling and permissible water temperature.
	Always select the lowest required temperature. Higher temperature means higher power consumption.
	For further programme details, see "programme and consumption table"

5.5 Main programmes

Depending on the type of fabric, use the following main programmes.

• Cotton

Use this programme for cotton laundry (such as bed sheets, duvet and pillowcase sets, towels, bathrobes, underwear, etc.). Laundry will be washed with a vigorous washing action and for a longer washing cycle.

• Synthetics

Use this programme to wash synthetic clothes (shirts, blouses, synthetic/cotton blends, etc.). This programme washes with a gentle action and has a shorter washing cycle compared to the Cottons programme. For curtains and tulle, use the Synthetic 40°C programme with prewash and anti-creasing functions selected. As their meshed texture causes excessive foaming, wash the veils/tulle by putting a little amount of detergent into the main wash compartment. Do not put detergent in the prewash compartment.

• Wool

Use this programme to wash your woollen clothes. Select the appropriate temperature complying with the tags of your clothes. Use appropriate detergents for wool.

5.6 Additional programmes

For special cases, additional programmes are available on the machine.



Additional programmes may differ according to the model of the machine

• Cotton Eco

Wash normally soiled, durable cotton and linen laundry in this programme with the highest energy and water saving compared to all other wash programmes suitable for cottons. Actual water temperature may differ from the declared cycle temperature. Programme duration may automatically be shortened during later stages of the programme if you wash a lesser amount (e.g. ½ capacity or less) of laundry. In this case energy and water consumption will be further decreased giving a more economical wash. This feature is only available on models having remaining time display.

• Child care

Use this programme to wash baby laundry, and laundry for persons with sensitive skin or allergies. A longer heating time and an additional rinsing step provide a higher level of hygiene.

• Hand wash

Use this programme to wash your woollen/delicate clothes that do not have “not machine-washable” tags and for which hand washing is recommended. This programme washes laundry with a very gentle washing action so not as to damage clothes.

• Quick Wash

Use this programme to wash your lightly soiled cotton clothes in a short time.

If not all the detergent has been dissolved in the Quick Wash programme

Use a lesser dosage of detergent if the Quick Wash programme is used frequently. Ensure that you do not overdose with detergent as the Quick Wash programme may not dissolve all the detergent.

• Xpress 14 min

Use this programme to wash a little amount of lightly soiled cotton clothes in a short time.

• Dark Colours

Use this programme to wash dark coloured laundry or laundry that you do not want to fade. Washing is performed with little mechanical action and at low temperatures. It is recommended to use liquid detergent or woollen shampoo for dark coloured laundry.

• Mix 40

Use this programme to wash your cotton and synthetic clothes together without having to sort them.

• Shirts

Use this programme to wash shirts made of cotton, synthetic and synthetic blended fabrics together.

• Refresh

Use this programme to remove the odour on laundry that has been worn only once and does not have any stains.

• Eco Wash 20

Use this environmentally friendly programme to wash lightly soiled and unstained cotton laundry (max. 3 kg) economically and in a short time. Defy recommends the use of a good quality liquid detergent when using the ECO wash programme - these dissolve rapidly and rinse out easily from the clothes.

If not all the detergent has been dissolved in the Eco Wash 20 programme

Use a lesser dosage of detergent if the ECO Wash 20 programme is used frequently. Ensure that you do not overdose with detergent as the ECO Wash 20 programme may not dissolve all the detergent.

• Self Clean



It is recommended to use liquid detergent or gel washing detergent for this programme.

Use this programme regularly (once in every 1-2 months) to clean the drum. Run the programme without any laundry in the machine allowing the machine to run through the full cycle. Dose your machine with a standard dose of detergent, or use 100 grams of dishwasher detergent, NOT WASHING SODA or put powder limescale remover for washing machines into the detergent compartment no. “2”. When the programme is over, leave the loading door ajar so that the inside of the machine can dry.



This is not a washing programme. It is a maintenance programme.



Do not run the programme when there is something in the machine. If you try to do so, the machine detects that there is a load inside and aborts the programme.

5.7 Special programmes

For specific applications, select any of the following programmes.

• Rinse

Use this programme when you want to rinse or starch separately.

• Spin + Drain

Use this programme to apply an additional spin cycle for your laundry or to drain the water in the machine.

Before selecting this programme, select the desired spin speed and press the Start / Pause / Cancel button. The machine will spin the laundry at the set spin speed and drain the water from the clothes.

If you wish to drain the water only without spinning the laundry, select the Pump+Spin programme and then select the No Spin function along with the Spin Speed Adjustment button. Press Start / Pause / Cancel button.

	Use a lower spin speed for delicate laundry
---	---

5.8 Temperature selection

Whenever a new programme is selected, the maximum temperature for the selected programme appears on the temperature indicator.

To decrease the temperature, press the Temperature Adjustment button. Temperature decreases with increments of 10° and finally, the “-” symbol indicating the cold wash option appears on the display.

	If you scroll to the cold wash option and press Temperature Adjustment button again, the recommended temperature for the selected programme appears on the display. Press the Temperature Adjustment button again to decrease the temperature.
---	--

Economy symbol

Indicates the programmes and temperatures that provide energy savings.

	The Economy symbol can not be selected in Intensive and Hygiene programmes since washing is performed for long time periods and at high temperatures in order to provide for a hygienic wash. Similarly, the Economy symbol can not be selected in the Child care Refresh, Drum Cleaning, Spin and Rinse programmes.
---	--

5.9 Spin speed selection

Whenever a new programme is selected, the recommended spin speed of the selected programme is displayed on the spin speed indicator.

To decrease the spin speed, press the Spin Speed Adjustment button. The spin speed decreases gradually. Then, depending on the model of the product, "Rinse Hold" and "No Spin" options appear on the display. See the "Auxiliary function selection" section for explanations of these options. (5.11).

	Rinse Hold option is indicated with “_” symbol and No Spin option is indicated with “_” symbol.
---	---

5.10 Programme and consumption table

EN						Auxiliary functions					
Programme (°C)		Max. Load (kg)	Water Consumption (l)	Energy Consumption (kWh)	Max. Speed***	Prewash	Quick Wash	Rinse Plus	Anti-Creasing	Rinse Hold	Selectable temperature range °C
Cotton	90	6	65	1.90	1600	•	•	•	•	•	90-Cold
Cotton	60	6	63	1.30	1600	•	•	•	•	•	90-Cold
Cotton	40	6	63	0.70	1600	•	•	•	•	•	90-Cold
Child care	90	6	60	2.00	1600			*		•	90-30
Cotton Eco	60**	6	44	1.01	1600					•	60-Cold
Cotton Eco	60**	3	37	0.82	1600					•	60-Cold
Cotton Eco	40**	3	37	0.64	1600					•	60-Cold
Cotton Eco	40	6	65	0.66	1600					•	60-Cold
Synthetics	60	2.5	40	0.90	1200	•	•	•	•	•	60-Cold
Synthetics	40	2.5	40	0.40	1200	•	•	•	•	•	60-Cold
Eco Wash 20	20	3	35	0.16	1600					•	20
Mix40	40	3	40	0.40	1200	•	•	•	•	•	40-Cold
Shirts	40	2.5	40	0.45	800	•	•	•	*	•	60-Cold
Xpress 14 min	30	2	35	0.10	1400			•		•	30-Cold
Quick Wash	90	3	60	1.70	1400			•		•	90-Cold
Quick Wash	60	3	60	1.00	1400			•		•	90-Cold
Quick Wash	30	3	70	0.20	1400			•		•	90-Cold
Wool	40	1.5	40	0.20	1200			•		•	40-Cold
Hand wash	30	1	30	0.15	1200						30-Cold
Dark Colours	40	2.5	30	0.40	1200			*		•	40-Cold
Self Clean	70	-	90	2.20	800			*			70
Refresh	-	2	20	0.03	1200					•	-

• : Selectable



* : Automatically selected, no cancelling.

** : Energy Label programme (EN 60456 Ed.3)

*** "Cotton Eco 40°C and Cotton Eco 60°C are standard programmes." These programmes are referred to as 'standard 40°C cotton programme' and 'standard 60°C cotton programme'

*** If the maximum spin speed of the machine is lower then this, only the maximum spin speed can be selected.

- : See the programme description for maximum load.

	The auxiliary functions in the table may vary according to the model of your machine.
	Water and power consumption may vary subject to the changes in water pressure, water hardness and temperature, ambient temperature, type and amount of laundry, selection of auxiliary functions and spin speed, and changes in the mains voltage.
	You can see the washing time of the programme you have selected on the display of the machine.

5.11 Auxiliary function selection

Select the desired auxiliary functions before starting the programme. Auxiliary functions suitable to the running programme may also be selected or cancelled by pressing the Start / Pause / Cancel button whilst the machine is operating.

Depending on the programme, press a, b, c or d buttons to select the desired auxiliary function. The symbol of the selected auxiliary function appears on the display.

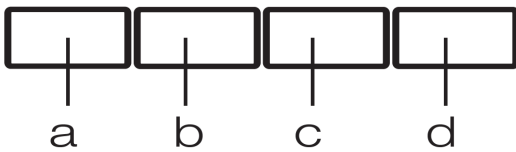

	Some functions cannot be selected together. If a second auxiliary function conflicting with the first one is selected before starting the machine, the function selected first will be cancelled and the second auxiliary function selection will remain active. For example, if you want to select Quick Wash after you have selected the Prewash, Prewash will be cancelled and Quick Wash will remain active.
	An auxiliary function that is not compatible with the programme cannot be selected. (See "Programme and consumption table")
	Auxiliary Function buttons may vary according to the model of the machine.

Prewash

A Prewash is only worthwhile for heavily soiled laundry. Not using Prewash will save energy, water, detergent and time.

F1 appears on the display when you select this function (a).

• Quick Wash

This function can be used for Cottons and Synthetics programmes. It decreases washing times and also the number of rinsing steps for lightly soiled laundry.

F2 appears on the display when you select this function (b).

	When you select this function, load your machine with half of the maximum laundry specified in the programme table.
--	---

• Rinse Plus

This function enables the machine to rinse

again in addition to the rinse already performed after the main wash. Detergent remnants on the laundry can be reduced in this way. (Babies clothing etc.).

F3 appears on the display when you select this function (c).

• Anti-Creasing

Drum movement is reduced and the spinning speed is limited to help prevent creasing on clothes being washed. Washing is done with a higher water level. F4 appears on the display when this function is selected (d).

• Rinse Hold

If clothes are not going to be unloaded immediately after the programme completes, use the rinse hold function to keep laundry in the final rinsing water to help prevent wrinkling. Press the Start / Pause / Cancel button after this process to drain the water without spinning your laundry. The programme will resume and complete after draining the water. To spin the laundry held in the water, adjust the Spin Speed and press the Start / Pause / Cancel button.

The programme resumes, water is drained, laundry is spun and the programme completes.

• Rinse Plus

This function helps to remove pet hair on your garments. When selecting this function, Prewash and Extra Rinse steps are added to the normal programme. Washing is performed with more water (30%) thus removing pet hair more effectively.

	Never wash your pets in the washing machine.
--	--

5.12 Time display

The remaining time to complete the programme appears on the display while the programme is running. Time is displayed as "01:30" in an hours and minutes format.

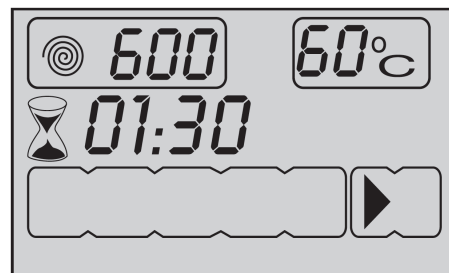

	Programme time may differ from the values in the "Programme and consumption table" depending on water pressure, water hardness and temperature, ambient temperature, amount and type of laundry, auxiliary functions selected and changes in the mains voltage.
--	---

Delayed start

With the Delayed Start function the start-up of the programme may be delayed up to 24 hours. The Delayed start time can be increased by increments of 30 minutes.

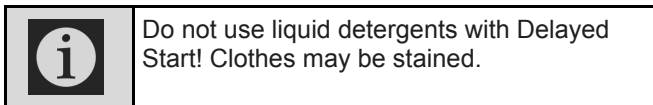

Open the loading door, place the laundry and add detergent etc. Select the washing programme, temperature, spin speed and, if required, the auxiliary functions. Set the desired delayed start time by pressing the Delayed Start + or - buttons. The Delayed Start symbol flashes. Press the Start / Pause / Cancel button. The Delayed start countdown begins. The Delayed Start symbol illuminates. The Start symbol appears. The “:” sign on the display starts to flash.

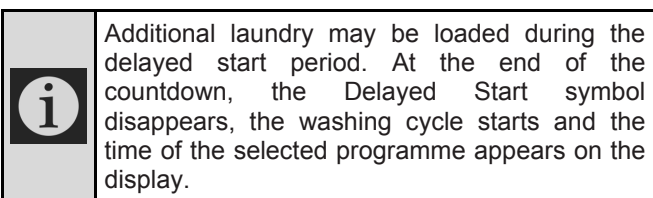

Changing the delayed start period

To change the time during countdown: Press Start / Pause / Cancel button. The “:” sign on the display stops flashing. The Pause symbol appears. The Delayed Start symbol flashes. The Start symbol disappears. Set the desired delayed start time by pressing the Delayed Start + or - buttons. Press Start / Pause / Cancel button. The Delayed Start symbol illuminates. The Pause symbol disappears. The Start symbol appears. The “:” sign on the display starts flashing.

Cancelling the Delayed Start function

To cancel the delayed start countdown and start the programme immediately: Press Start / Pause / Cancel button. The “:” sign on the display stops flashing. The Start symbol disappears. The Pause symbol and Delayed Start symbol flashes. Decrease the delayed start time by pressing the Delayed Start - button. Programme duration appears after 30 minutes. Press the Start / Pause / Cancel button to start the programme.

5.13 Starting the programme

Press the Start / Pause / Cancel button to start the programme. The Start symbol showing the start-up of the programme will show. The loading door is locked and Door Locked symbol appears on the display. The symbol of the step from which the programme has started appears on the display (Prewash, Main Wash, Rinse, Softener and Spin).

5.14 Progress of programme

Progress of a running programme is indicated on the display with a set of symbols.

The relevant symbol appears on the display at the beginning of each programme step and all symbols remain lit at the end of the programme. The farthest right symbol indicates the current programme step.

Prewash

If the Prewash auxiliary function is selected, the Prewash symbol appears on the display indicating that the prewash step has started.

Main Wash

The Main Wash symbol indicating that the main wash step has started appears on the display.

Rinse

The Rinse symbol indicating that the rinsing step has started appears on the display.

Softener

The Softener symbol indicating that the softener step has started appears on the display.

Spin

Appears at the beginning of the final spin step and remains lit during Spin and Pump special programmes.

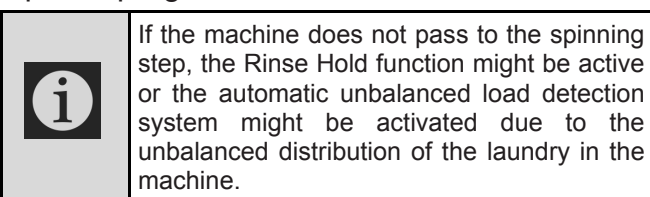

5.15 Loading door lock

There is a locking system on the loading door of the machine that prevents the opening of the door in cases when the water level is not suitable for the door to be opened.

The Door Locked symbol appears when the loading door is locked. This symbol will flash until the loading door is ready to be opened, either when programme completes or when the machine is paused. Do not force open the loading door. The Symbol will disappear when the door is ready to open. Only open the door when the symbol disappears.

5.16 Changing the selections after programme has started

Switching the machine to pause mode
Press the Start / Pause / Cancel button to switch the machine to pause mode. The Pause symbol appears on the display indicating that the machine is paused. The Start symbol disappears.

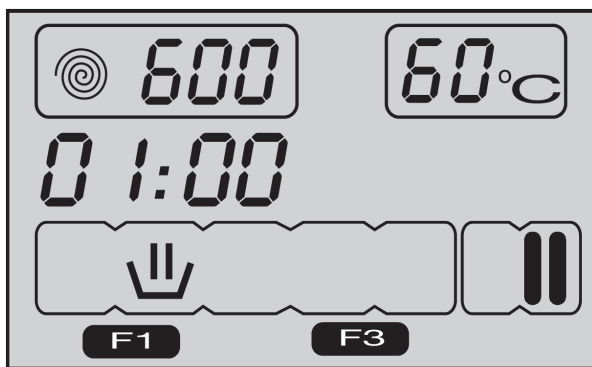

Changing the speed and temperature settings for auxiliary functions

Depending on the step the programme has reached, you may cancel or activate the auxiliary functions; see, "Auxiliary function selection".

You may also change the speed and temperature settings; see, "Spin speed selection" and "Temperature selection".

Adding or taking out laundry

Press the Start / Pause / Cancel button to switch the machine to pause mode. The programme follow-up light of the relevant step during which the machine was switched into during the pause mode will flash. Wait until the Loading Door can be opened. Open the Loading Door and add or take out the laundry. Close the Loading Door. Make changes in auxiliary functions, temperature and speed settings if necessary. Press the Start / Pause / Cancel button to start the machine.

i The loading door will not open if the water temperature in the machine is high or the water level is above the door opening.

5.17 Child Lock

Use the Child Lock function to prevent children from tampering with the machine, thus preventing any changes being made to a running programme.

i Switch the machine on and off with the On / Off button when the Child Lock is active. When you switch the machine on again, the programme will resume from where it has stopped.

To activate the Child Lock

Press and hold the 2nd and 4th Auxiliary Function buttons for 3 seconds. "Con" appears on the display.

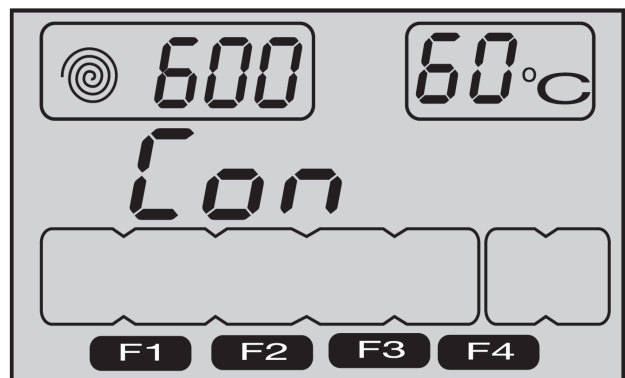

i The same phrase will appear on the display if you press any button when Child Lock is enabled.

To deactivate the Child Lock:

Press and hold 2nd and 4th Auxiliary Function buttons for 3 seconds. "COFF" appears on the display.

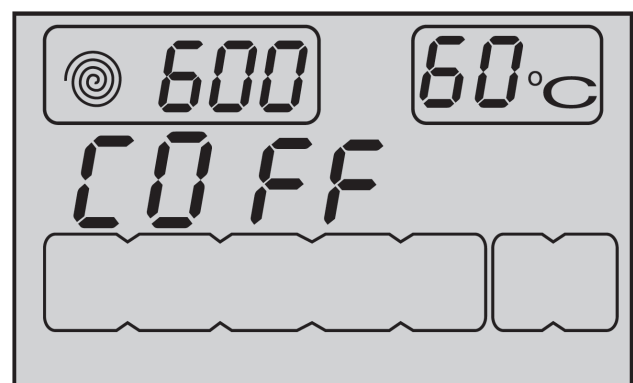

i Do not forget to disable the child lock at the end of the programme if it was enabled before. If the child lock is not disabled the machine will not allow you to select a new programme.

5.18 Cancelling the programme

Press and hold the Start / Pause / Cancel button for 3 seconds. The Start symbol flashes. The symbol of the step at which the programme was cancelled remains lit. "End" appears on the display and the programme is cancelled.

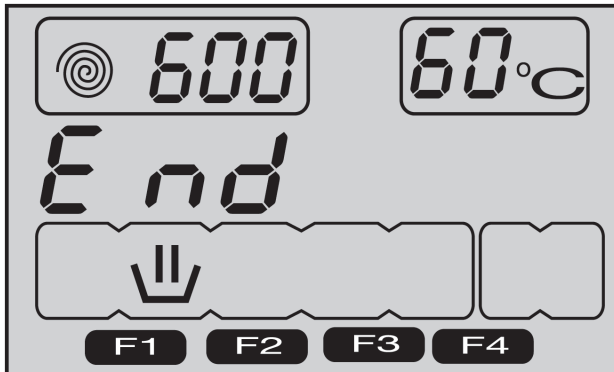

To open the loading door after you have cancelled a programme and the water level in the machine is above the loading door opening, first turn the Programme Selection knob to the Pump+Spin programme and discharge the water in the machine.

5.19 Machine is in Rinse Hold mode

The Spin symbol flashes and the Pause symbol illuminates when the machine is in Rinse Hold mode.

If you want to spin your laundry when the machine is in this mode:

Adjust the spin speed and press the Start / Pause / Cancel button. The Pause symbol disappears and the Start symbol appears. The programme resumes, discharges the water and spins the laundry.

If you only want to drain the water without spinning:

Press the Start / Pause / Cancel button. The Pause symbol disappears. The Start symbol appears. The programme resumes and discharges the water only.

5.20 End of programme

"End" appears on the display at the end of the programme. The symbols of the programme steps remain lit. The auxiliary function, spin speed and temperature that were selected at the beginning of the programme remain selected.

6 Maintenance and cleaning

The service life of the machine can be extended if it is cleaned at regular intervals. Regular cleaning also helps to alleviate possible problems.

6.1 Cleaning the detergent drawer

Clean the detergent drawer at regular intervals (every 4-5 washing cycles) as shown below in order to prevent the accumulation of powder detergent over time.

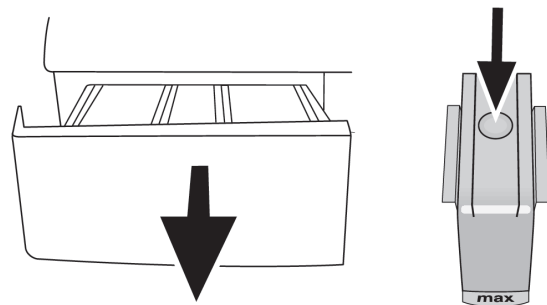

1. Press the dotted point on the siphon in the softener compartment and pull it towards yourself until the compartment is removed from the machine.



If an excess amount of water and softener mixture starts to accumulate in the softener compartment, the siphon must be cleaned.

2. Wash the detergent drawer and the siphon with plenty of lukewarm water in a wash basin. Wear protective gloves or use an appropriate brush to avoid skin contact with the residues in the drawer whilst cleaning.

3. Insert the drawer back into its place after cleaning and make sure that it is properly seated.

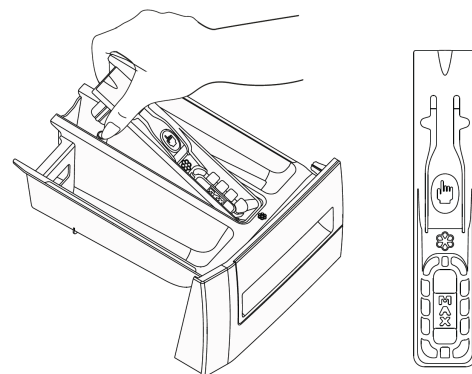

The detergent drawer of models in the range may differ.



Lift the rear part of the siphon to remove it as illustrated. After performing the above mentioned cleaning procedures, replace the siphon back into its seating and push its front section downwards and ensure that the locking tab engages.

6.2 Cleaning the loading door and the drum

Residues of softener, detergent and dirt may accumulate in your machine in time and may cause unpleasant odours and a deterioration in washing quality. To avoid this, use the **Drum Cleaning programme**. If your machine is not featured with the Drum Cleaning programme, use the Cottons-90 programme and select **Additional Water** or the Extra Rinse auxiliary functions as well. Run the Drum cleaning programme before starting the programme, put max. 100 g of powder anti-limescale into the main wash detergent compartment (compartment no. "2"). If the anti-limescale is in tablet form, put only one tablet into compartment no. "2". Dry the inside of the bellow with a clean piece of cloth after the programme has come to an end.

	Repeat the Drum Cleaning process every 2 months.
	Use an anti-limescale suitable for the washing machines.

After every wash make sure that no foreign substances are left in the drum.

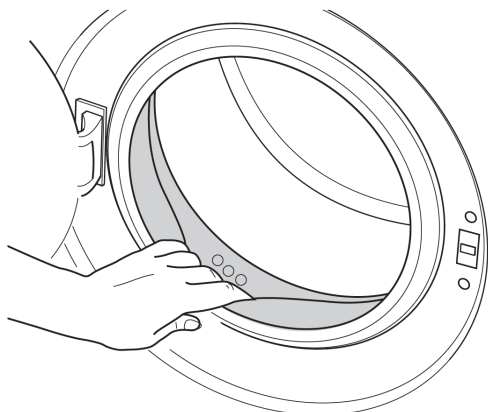

If the holes on the bellow (shown in the figure) are blocked, carefully open the holes using a toothpick.

	Foreign metal substances will cause rust stains in the drum. Clean the stains on the drum surface by using cleaning agents suitable for stainless steel. Never use steel wool or wire wool.
---	---

	Warning: Never use sponge or scrub materials. These will damage the painted and plastic surfaces.
---	--

6.3 Cleaning the body and control panel

Wipe the body of the machine with soapy water or non-corrosive mild gel detergents as necessary, and dry with a soft cloth. Use only a soft and damp cloth to clean the control panel.

6.4 Cleaning the water intake filters

There is a filter at the end of each water intake valve at the rear of the machine and also at the end of each water intake hose where they are connected to the tap. These filters prevent foreign substances and dirt in the water from entering the washing machine. Filters should be cleaned regularly as they do get dirty.

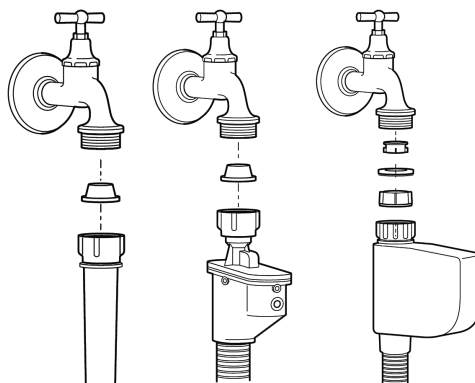

1. Close the taps.
2. Remove the nuts of the water intake hoses to access the filters on the water intake valves. Clean them with an appropriate brush. If the filters are very dirty, remove them with the aid of a pair of pliers and then clean them.
3. Take out the filters on the flat ends of the water intake hoses together with the gaskets and clean thoroughly under running water.
4. Correctly replace the gaskets and filters carefully and tighten the hose nuts by hand.

6.5 Draining remaining water and cleaning the pump filter

The filter system in your machine prevents solid items such as buttons, coins and fabric fibre's clogging the pump impeller during the discharge of washing water. Thus, the water will be discharged without any problems and the service life of the pump will extend.

If the machine fails to drain water, the pump filter is clogged. The filter must be cleaned whenever it is clogged or every 3 months. Water must first be drained off in order to clean the pump filter.

Water may have to be drained completely, prior to transporting the machine (e.g., when moving to another house) and in case of water freezing.

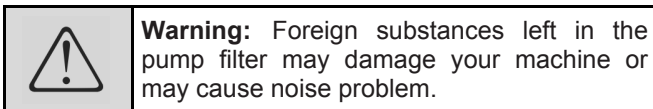

In order to clean the dirty filter and discharge the water:

1. Unplug the machine to cut off the power supply.

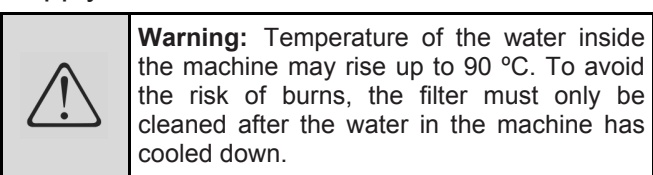

2. Open the filter cap.

If the filter cap is composed of two pieces, press the tab on the filter cap downwards and pull the piece out towards yourself.

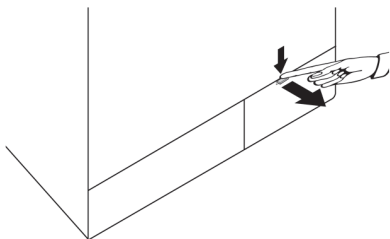

If the filter cap is one piece, pull the cap from both sides at the top to open.

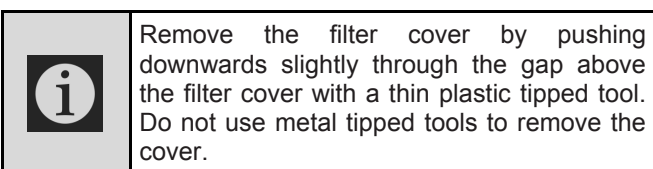
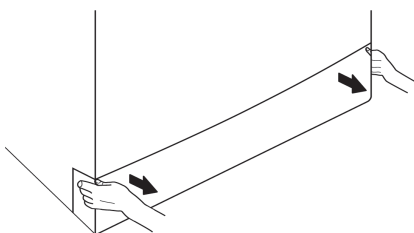

3. The emergency draining hose is model specific and may not be on your machine. Follow the steps to discharge the water:

Discharging the water when the product has an emergency draining hose:

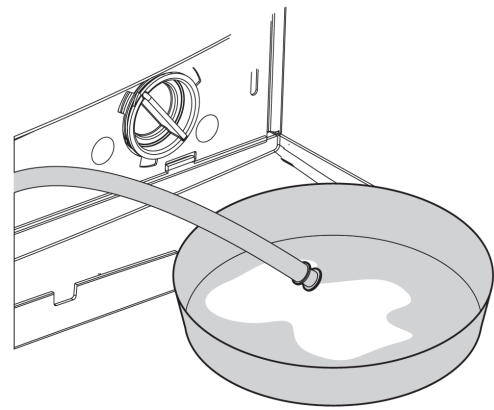

a. Pull the emergency draining hose out from its seat

b. Place a large container at the end of the hose. Drain the water into the container by pulling out the plug at the end of the hose. When the container is full, block the inlet of the hose by replacing the plug. After the container is emptied, repeat the above procedure to drain the remaining water in the machine completely.

c. When the draining of the water has completed, close the end with the plug and fix the hose in its place.

Discharging the water when the machine does not have an emergency draining hose

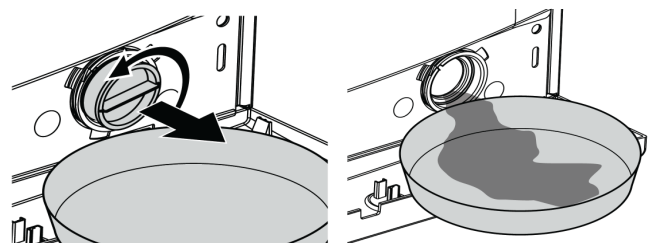

a. Place a large container in front of the filter to catch water from the filter.

b. Loosen the pump filter (anticlockwise) until water starts to flow. Drain the flowing water into the container placed in front of the filter. Always keep a piece of cloth handy to absorb any spilled water.

c. When there is no more water left inside the machine, remove the filter completely by turning it.

4. Clean any residues inside the filter as well as fibre's, if any, around the pump impeller region.



5. Reinstall the filter.

6. If the filter cap is composed of two pieces, close the filter cap by pressing on the tab. If it is one piece, first seat the tabs in the lower part into their places, then press the upper part to close.

7 Technical specifications

Models (EN)	DAW 369	DAW 370
Maximum dry laundry capacity (kg)	6	6
Height (cm)	84	84
Width (cm)	60	60
Depth (cm)	48	48
Net weight (±4 kg.)	59	59
Electrical input (V/Hz)	220 V / 50Hz	220 V / 50Hz
Total current (A)	10	10
Total power (W)	2000	2000
Spin speed (rpm max.)	1000	1000
Stand-by mode power (W)	1.40	1.40
Off-mode power (W)	0.20	0.20
Single water inlet/Double water inlet	• / -	• / -

• Available

	The manufacturer strives for continuous improvement. For this reason, technical specifications, text and illustrations in this manual are subject to change without notice.
	Figures in this manual are schematic and may not match your machine exactly.
	Values stated on the machine labels or in the documentation accompanying it are obtained in laboratory conditions in accordance with the relevant standards. Depending on operational and environmental conditions of the product, these values may vary.

8 Trouble shooting

Programme cannot be started or selected.

- Washing machine has switched to self protection mode due to a supply problem (line voltage, water pressure, etc.). >>> *Press and hold Start / Pause button for 3 seconds to reset the machine to factory settings. (See "Cancelling the programme")*

Water in the machine.

- Some water might have remained in the product due to the quality control processes in production. >>> *This is not a failure; water is not harmful to the machine.*

Machine vibrates or makes noise.

- Machine might not be levelled. >>> *Adjust the feet to level the machine.*
- A hard substance might have entered into the pump filter. >>> *Clean the pump filter.*
- Transportation safety bolts are not removed. >>> *Remove the transportation safety bolts.*
- Laundry quantity in the machine might be too little. >>> *Add more laundry to the machine.*
- Machine might be overloaded with laundry. >>> *Take out some of the laundry from the machine or distribute the load by hand to balance it homogenously in the machine.*
- Machine might be resting on a rigid item. >>> *Make sure that the machine is not resting on any obstructions or rigid items.*

Machine stopped shortly after the programme started.

• Machine might have stopped temporarily due to low voltage. >>> *It will resume running when the voltage restores to the normal level.*

Programme time does not countdown. (On models with display)

• Timer may stop during water intake. >>> *Timer indicator will not countdown until the machine takes in an adequate amount of water. The machine will wait until there is a sufficient amount of water to avoid poor washing results due to lack of water. Timer indicator will resume countdown after this.*

• Timer may stop during heating step. >>> *The Timer indicator will not countdown until the machine reaches the selected temperature.*

• Timer may stop during the spinning step. >>> *The automatic unbalanced load detection system might be activated due to the unbalanced distribution of the laundry in the drum.*

 The machine does not switch to the spinning step when the laundry is not evenly distributed in the drum to prevent any damage to the machine and to its surrounding environment. Laundry should be rearranged and re-spun.

Foam is overflowing from the detergent drawer.

Too much detergent is used. >>> *Mix 1 tablespoonful softener and ½ l water and pour into the main wash compartment of the detergent drawer.*

 Only use detergent in the machine suitable for the programmes and refer to maximum loads indicated in the “Programme and consumption table”. When using additional chemicals (stain removers, bleaches etc.), reduce the amount of detergent.

Laundry remains wet at the end of the programme.

Excessive foam might have occurred and automatic foam absorption system might have been activated due to too much detergent usage. >>> *Use recommended amount of detergent.*

 The machine does not switch to spinning step when the laundry is not evenly distributed in the drum to prevent any damage to the machine and to its surrounding environment. Laundry should be rearranged and re-spun

If not all the detergent has been dissolved in the programme:

Use a lesser dosage of detergent if the ECO Wash 20 or Quick Wash programmes are used frequently. Ensure that you do not overdose with detergent as the ECO Wash 20 and Quick wash programmes may not dissolve all the detergent.



Warning: If the problem cannot be eliminated, even after the instructions have been followed, consult with your dealer or Authorized Service Agent. Never try to repair a non-functional machine yourself.

9 Owner's responsibility

SINCE THE FOLLOWING ARE NOT FACTORY FAULTS, THEY ARE THE OWNER'S RESPONSIBILITY

- Damage to the exterior finish, breakage of components, damage through improper use or installation of the washing machine or damage caused by moving the washing machine.

Before calling a Service technician or your dealer, please check the following:

- Is the machine plugged into the wall socket? Is the house circuit breaker on?
- Is the machine switched on? Has the machine door been closed properly?
- Is the detergent dose correct? Is the filter clean? Is the tap open?
- Is there a water supply to the home? Have any of the hoses been twisted or kinked?

10 Service Centres

BLOEMFONTEIN 160 Long Street, Hilton,
Bloemfontein 9301.
Tel. 051 400 3900
Bloemfontein.Service@defy.co.za

CAPE TOWN 5A Marconi Rd.
Montague Gardens, 7441.
Tel. 021 528 3000
CapeTown.Service@defy.co.za

DURBAN 35 Intersite Avenue,
Umgeni Business Park, Durban 4051.
Tel. 031 268 3300
Durban.Service@defy.co.za

EAST LONDON 16 Bowls Rd. Arcadia,
East London 5201.
Tel. 043 743 7100
EastLondon.Service@defy.co.za

JOHANNESBURG Cnr. Mimetes & Kruger Sts. Denver ext.12
Commercial Head Office,
Administration, Distribution, National Groups,
Tel. Sales, Contracts and Credit.
Johannesburg. 2094.
Tel. 011 621 0200 or 011 621 0300
Gauteng.Service@defy.co.za

POLOKWANE 87 Nelson Mandela Drive.
Superbia 0699.
Tel. 0152 92 1166 / 7 / 8 / 9.
Polokwane.Service@defy.co.za

PORT ELIZABETH 112 Patterson Road,
North End, Port Elizabeth 6001.
Tel. 041 401 6400
PortElizabeth.Service@defy.co.za

PRETORIA. Block A1 Old Mutual Industrial Park.
Cnr. D.F.Malan Drive & Moot Str.
Hermanstad. 0082.
Tel. 012 377 8300
Pretoria.Service@defy.co.za

**OTHER AREAS ARE SERVICED BY OVER 200 AUTHORISED AGENTS.
FOR FURTHER DETAILS PLEASE CONSULT THE NEAREST REGIONAL
DEFY TECHNICAL SUPPORT CENTRE**

11 Warranty

This certificate is issued by DEFY APPLIANCES LIMITED manufacturers of Defy and Ocean products, hereinafter the Company, to the original purchaser only, of the appliance described on the certificate and shall constitute the only warranty given in respect of this appliance.

The Company warrants to the original purchaser that for a period of TWO YEARS from date of purchase the appliance is free from defect under normal domestic use, both in workmanship and material, subject to the following conditions.

1. Repair or replacement of any part of this appliance, found by the Company to be defective, shall be at the election of the Company. The Company reserves the right to effect such service through any of its Service Divisions or Authorised Service Dealers. The cost of such service shall be borne by the Company in full, provided that the appliance is located no further than 50km from a Company Service Centre or an Authorised Service Dealer. Where the appliance is located beyond the 50km radius, the purchaser shall be liable for the standard travelling charges, as determined by the Company.
2. Vitreous enamelware, fuses and lamps are specifically excluded from these warranties. It is an express condition of these warranties that the purchaser takes due care and attention in the use and maintenance of the appliance. Abuse, misuse in conflict with operating instructions, connection to incorrect voltages and subjection to commercial use shall release the Company from its obligations.
3. This warranty shall become void and cease to operate if the appliance is dismantled by, or any repairs to the appliance are effected by any persons not duly authorised by the Company, or if substitute parts not approved by the Company are used in the appliance, or if the serial number of the appliance is removed.
4. The Company shall not be responsible for damages resulting from fire, flood, civil disturbances or any Act of God. The Company shall not, in terms of these warranties be responsible nor held liable for any consequential loss or damage of any kind caused by or due to the failure or malfunction of the appliance.
5. The Company shall not be responsible for transportation or other costs other than those incurred within the provisions of Point 1 of this Certificate.
6. These warranties shall not apply to the appliance if it is purchased or used beyond the borders of the Republic of South Africa, Namibia, Botswana, Swaziland and Lesotho.
7. Where service is requested under warranty and no fault or defect can be found by the Company, all costs incurred will be for the purchaser's account.
8. This Certificate as well as your invoice will serve as proof of purchase. For the purpose of warranty, it will be essential to produce this Certificate and invoice. Failure to do so, will render the purchaser liable for service costs.

**KEEP THIS CERTIFICATE AND SALES INVOICE AS
PROOF OF PURCHASE FOR WARRANTY PURPOSES.**

Free Manuals Download Website

<http://myh66.com>

<http://usermanuals.us>

<http://www.somanuals.com>

<http://www.4manuals.cc>

<http://www.manual-lib.com>

<http://www.404manual.com>

<http://www.luxmanual.com>

<http://aubethermostatmanual.com>

Golf course search by state

<http://golfingnear.com>

Email search by domain

<http://emailbydomain.com>

Auto manuals search

<http://auto.somanuals.com>

TV manuals search

<http://tv.somanuals.com>