

## INDEX

2. Introduction and special features
  - Installation
  - Unpacking
  - Transport fittings
3. Positioning the machine
  - Connection to the cold water supply
  - Connecting the drain hose
  - Electrical connection
4. Know your machine
  - Exterior
  - Accessories
  - Detergent drawer
5. Safety notes
  - Preparing clothes before washing
6. The control panel
  - Button descriptions
7. Safety Lock
  - Operating the machine
8. Wash programme guide
9. Cotton programme
10. Eco programme
11. Synthetic programme
12. Delicate programme
13. Wool programme
14. Hand wash programme
15. Quick wash
  - Spin only
16. Maintenance
17. Cleaning
  - International fabric care labels
18. Stain removal guide
19. Problem washing
  - Trouble shooting
20. Specifications
  - Wiring diagram
  - Owner's responsibility
21. Defy Service Centres
22. Warranty
23. Notes
24. Purchase details



You can rely on Defy. To simplify

## OWNER'S MANUAL

### **MAXIMAID 800 DAW 327(Metallic) DAW 328 (White)**

smart drive

**Automatic Washing Machine**



[www.defy.co.za](http://www.defy.co.za)

# Thank you for choosing Defy

Congratulations, you have purchased one of the finest and most modern washing machines that today's technology can produce. This manual will tell you all you need to know about your machine, what it will do and how to do it.

**Please read all the instructions carefully before operating the machine.**

Your machine is fitted with a smart drive directly driven motor the advantages of which are:

- **High torque at low rpm.**
- **Increased efficiency:** The power is not wasted in friction (from a drive belt or gearbox.)
- **Reduced noise:** Being a simpler device, a directly-driven mechanism has fewer parts which could vibrate, and the overall noise emission of the system is consequentially lower.
- **Longer life:** Having fewer moving parts also means having fewer parts prone to failure.

Other features are:

- **“A” Energy rated.**
- **Advanced electronics:** Sensors determine the optimum water level and wash duration.
- **Perforated drum paddles:** “Rain” action completely dissolve detergents thereby improving both the wash and rinsing performance.
- **Safety lock:** Prevents unintentional opening of the machine

## Installation

### UNPACKING

- Carefully remove all packaging from the machine and accessories.
- Please ensure that packaging material is disposed of in a responsible manner.
- Plastic bags should be cut up to prevent children playing with them and accidentally suffocating.
- If the appliance is damaged in any way, do not use it. Report the damage to your dealer, who will take the necessary corrective action.

### TRANSPORT FITTINGS

- The wash drum is secured by three bolts to prevent damage during transport .
- If these bolts and associated rubber sleeves are not removed before use, it will result in excessive vibration, noise and possible malfunction.
- To remove the transport fittings proceed as follows:

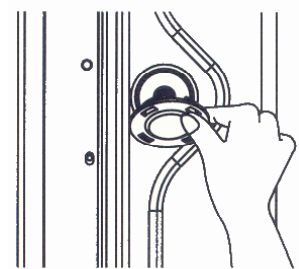
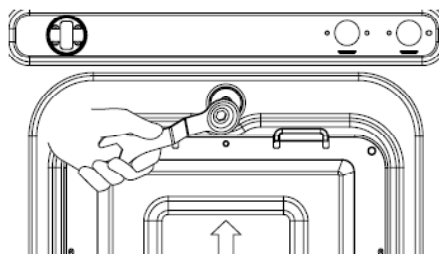
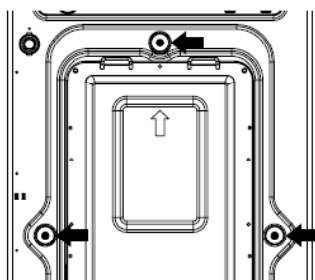

- Unscrew the 3 bolts at the back of the machine using a spanner.
  - Remove the bolts and rubber grommets.
  - Keep the transport fittings for future use.
  - To prevent damage, the machine should be transported with the transport fittings securely in place.
- Insert the 3 plastic plugs, supplied with the machine, into the holes vacated by the transport fittings.

## POSITIONING THE MACHINE

- The machine must stand firmly on the floor. Any instability will negatively effect its performance.
- To level the machine, loosen the lock nuts on the adjustable feet. Rotate the feet until the machine stands firm and level. Tighten the lock nuts firmly. Never remove the lock nuts and feet from the machine.
- Do not place the washing machine outdoors or in an area where the temperature could drop to below freezing. Residual water in the pipes could freeze and damage the machine.
- Adequate ventilation is important. Leave a space of 20mm to the left and right of the machine and 100mm at the back.
- Never place the machine on a carpet. This could prevent air circulation and cause electrical components in the machine to overheat.
- Do not place or store anything on top of the machine.

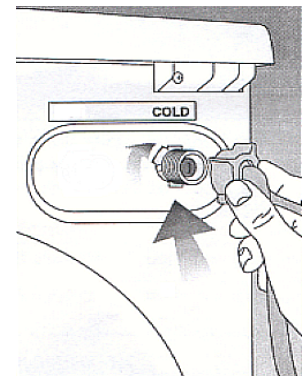
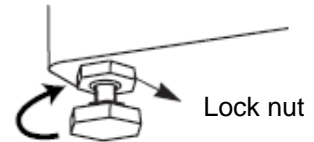
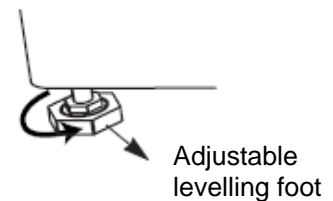

## CONNECTING TO THE COLD WATER SUPPLY

- The washer should be connected to the mains using a new hose an old hose should not be re-used
- The water supply should deliver 8 to 80 litres per minute.
- Sealing washers are supplied and these should be fitted at either end of the inlet hose.
- Secure one end of the inlet hose to the water inlet at the rear of the machine and the other end to a 3/4 inch BSP cold water tap.
- Tighten both connections. Open the tap and check for leaks.
- We recommend that the tap be closed when the machine is not in use.

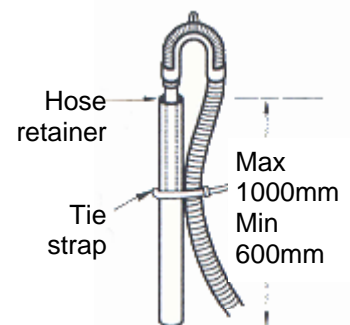

## CONNECTING THE DRAIN HOSE

### Draining into a dedicated outlet pipe

- The outlet pipe must have an inside diameter of at least 40 mm.
- The end of the pipe must be positioned between 600 mm. and 1000 mm. above floor level.
- Secure the hooked end of the drain hose into the outlet pipe.

### Draining into a sink or bath

- The drain hose may be hooked over the edge of a sink or bath in such a way that the end can not be immersed in the collected waste water.
- The outlet end of the hose must be between 600 mm. and 1000 mm. above floor level.
- **Please note:** The outlet hose must be kept free of kinks or restrictions as these will hinder the operation of the machine.

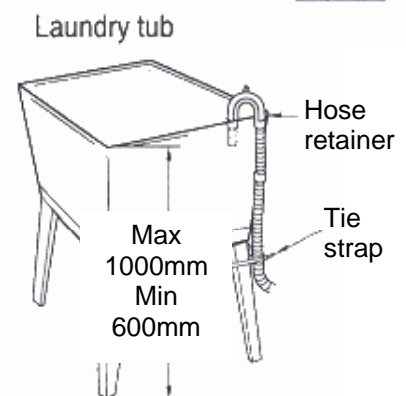

## ELECTRICAL CONNECTION

- **The appliance must be earthed and the manufacturer and seller do not accept responsibility for any damage due to incorrect electrical connection.**
- The three pin plug, attached to the power cord, must be inserted into a 15 Amp earthed wall socket.
- Do not connect the machine through a double adaptor. It requires a dedicated power point
- If the power cord should ever need replacing, use only a genuine cord ( Type 'X' ) available from the nearest Defy Service Centre.

# Know your machine

## EXTERIOR

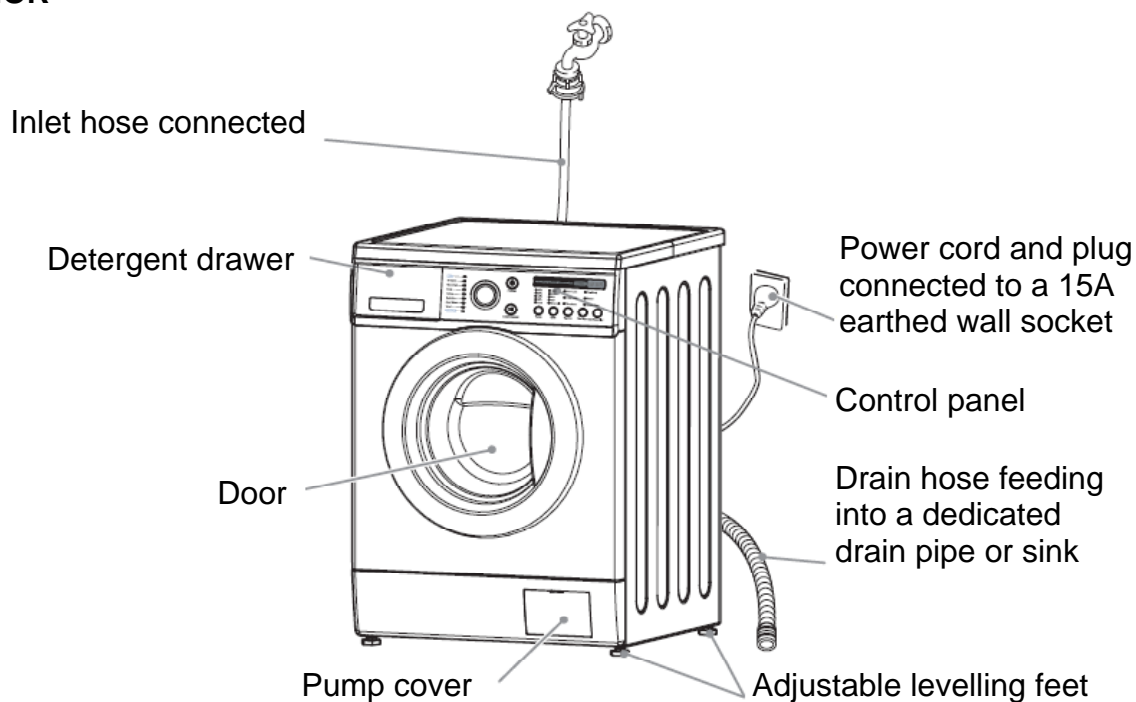

## ACCESSORIES



Inlet hose



Manual



Plugs

## DETERGENT DRAWER

- Open the drawer.
- Place detergent and softener in the appropriate compartment, in accordance with the instructions on the manufacturer's pack.
- Detergent and softener will automatically be released at the appropriate time during the wash.
- **Use only low foam detergents specifically designed for front loading washing machines.**
- **Over dosing may result in excessive foam, overload the motor and effect performance.**

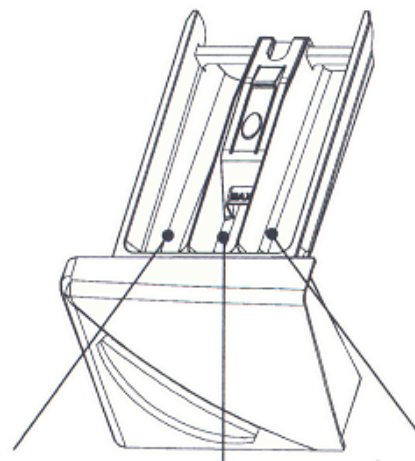

Main wash

Fabric softener

Pre-wash

## Safety notes

- The appliance must be installed and connected in accordance with the manufacturer's instructions.
- The appliance must only be used domestically and for the purposes for which it was designed.
- This appliance is not intended for use by persons (including children) with reduced physical, sensory or mental capabilities, or lack of experience and knowledge, unless they have been given supervision or instruction concerning use of the appliance by a person responsible for their safety. Children should be supervised to ensure that they do not play with the appliance.
- Flammable fluids (dry-cleaning solvents paraffin, petrol etc) should not be used in or stored near your washing machine.
- Do not use chlorine bleach, ammonia, rust remover, vinegar or acid in the machine.
- Do not wash fiberglass material as small particles could dislodge and cause skin irritation
- Do not spray water over the control panel as it could damage the electronic circuits.
- Do not reach into the machine until all motion stops
- Switch off and unplug the machine before cleaning, or servicing it.
- If the power cord is damaged it must be replaced by a qualified service technician.
- Do not operate the machine using an electrical extension cord.

## Preparing clothes before washing

- Sort washing by material type.
- Adhere to garment label washing instructions.
- Fasten zips to prevent them snagging other articles.
- Mend loose seams and tears before washing.
- Secure all loose buttons, tie strings and sashes.
- Empty all pockets of coins and loose objects.
- Secure or remove brassiere wires.
- Wash small articles such as socks, handkerchiefs, synthetic knits and delicate underwear in a wash bag or pillow slip. This will prevent tangling and avoid piling.
- Turn synthetic knits inside out to prevent piling
- Treat any stains before washing.
- Test fabrics for colourfastness before washing.
- Wash new denim separately as colours may run.
- Wash new bulky articles such as quilts and sleeping bags individually. For best results use the WOOL programme.
- Do not wash articles which have been soaked in paint, petrol, thinners, or other flammable liquids.
- Do not wash rubberised articles such as rain coats and training shoes.

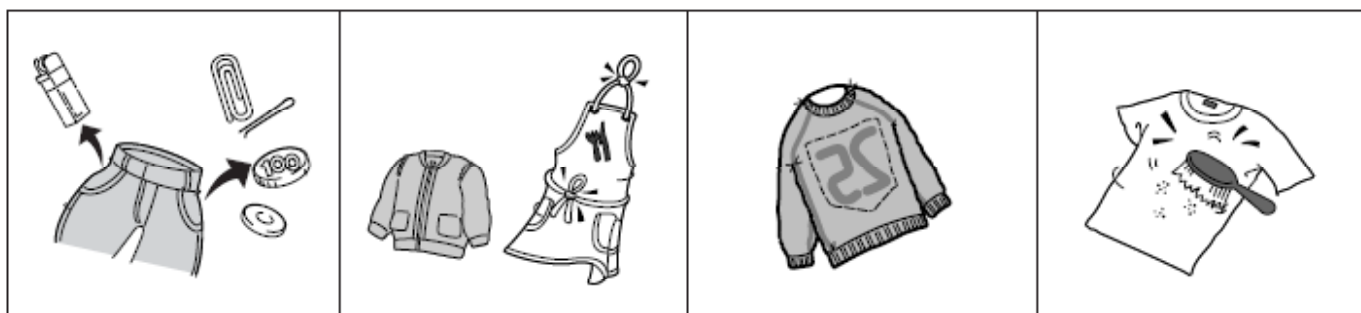

# The Control Panel

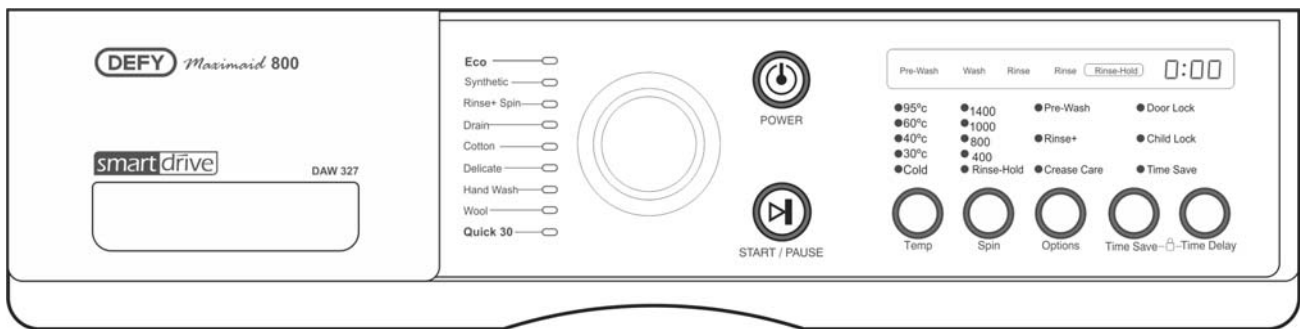

POWER

## POWER ON / OFF

- Press this button to switch the power ON or OFF.



START / PAUSE

## START / PAUSE

- Press this button to start the selected operation. Pressing it once more stops the machine temporarily, allowing changes to a programme to be made. Select the programme, make the changes and press the start / pause button once more to resume operation.

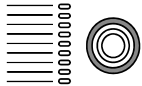

## PROGRAMME SELECTION

- Turn the knob to select the desired programme as indicated by the relevant light.
- See programme guide.



TEMP

## TEMPERATURE SELECTION

- Press the button repeatedly to select the required temperature.
- Sequential lights will confirm your selection.
- Cold > 30°C > 40°C > 60°C > 95°C > Cold.....



SPIN

## SPIN SPEED SELECTION

- Press the button repeatedly to select the required temperature.
- Sequential lights will confirm your selection.
- Rinse and hold > 400rpm > 800rpm > 1000 rpm > 1400rpm > Rinse and hold.....
- Rinse and hold leaves laundry suspended in water after a rinse cycle.
- To proceed after the Rinse and hold function, press the spin button once more.



OPTIONS

## CREASE CARE.

- Press this button together with spin speed to minimise creasing.

## RINSE+

- Press this button to add an extra rinse to the programme.

## PRE-WASH

- Press this button to add one additional wash and spin before the main wash.



TIME SAVE

## TIME SAVE

- Pressing this button decreases the wash time by 10 minutes.
- Time save may be used on Cotton, Eco and Synthetic programmes
- Pressing the button once more cancels the time save function.



TIME DELAY

## TIME DELAY

- By pressing this button repeatedly, you may delay the start time of your wash by 1 to 12 hours . The clock in the display window will confirm your selection.

# Safety lock

## SAFETY LOCK

- When activated, the Safety lock prevents accidental operation of the machine.
- **Activating the lock:**
- Press Time Save and Time Delay buttons simultaneously.
- In Safety Lock mode, no other button will function except the Power ON / OFF button.
- The Safety lock is cancelled when the power is switched off.
- **De-activating the Safety lock while there is power to the machine.**
- Press Time Save and Time Delay buttons simultaneously once more.

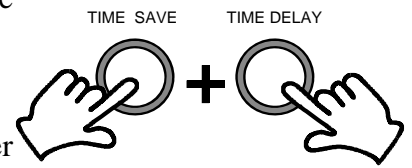

- **To change a programme while the safety lock is on.**
- Press both the Time save and Time delay buttons simultaneously .
- Press the Start hold button
- Set the desired programme.
- Press the Start hold button once more.

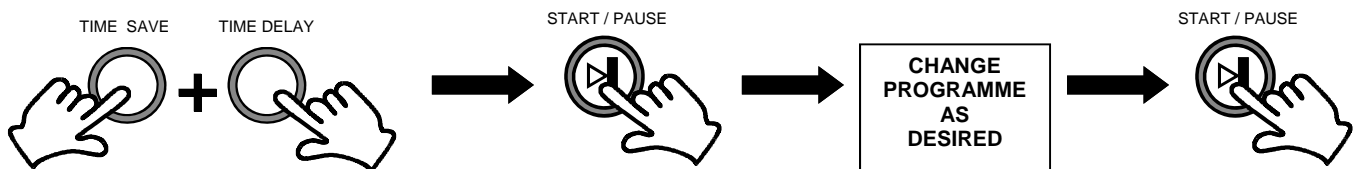

# Operating the machine

## SORTING THE LAUNDRY

Sort the laundry in one of the following groups:

- White cotton and linen as well as robust colourfast fabrics.
- Synthetics and synthetic blends as well as non colourfast fabrics.
- Delicate fabrics such as silks and rayon.
- Wool

## GETTING READY

- Open the cold water tap.
- Switch the power on at the wall socket.

## LOADING THE MACHINE

- Open the door and load the laundry into the drum. It is important not to overload the machine as this will prevent it from washing properly. You should be able to fit a hand between the top of the drum and the wash load in the drum. Items should be able to move easily through the wash water for best cleaning and wrinkle-free results
- Close the door.
- Add detergent as required for Pre-wash, and or Main wash.
- Add Softener to just below the MAX level.

## TIME DELAY

**This allows a programme to start later in the day. The start may be delayed by 2 to 12 hours**

1. Switch the water tap on , add detergent and load the washing. Close the door.
2. Select a programme
3. Press the Time Delay button
4. Adjust the time . Each press of the Time Delay button delays the start time by 1 hour
5. Press the Start/Hold button
6. The machine will start the selected programme at the selected (delayed ) time
7. To cancel the Time Delay, press the Power button.

# Wash programme guide

PROGRAMME	FABRIC TYPE	TEMP °C	SELECTABLE OPTIONS*	MAX. LOAD Kg
COTTON	MACHINE WASHABLE WHITE COTTON, LINEN, TOWLING AND BED SHEETS	60°C (95°C)	PRE-WASH RINSE+ CREASE CARE	8
	COLOURFAST GARMENTS. SHIRTS, NIGHT DRESSES, LIGHTLY SOILED COTTON AND UNDERWEAR	40°C (COLD 30°C) (60°C)	PRE-WASH RINSE+ CREASE CARE	8
ECO	SAME AS FOR COTTON	60°C	PRE-WASH RINSE+ CREASE CARE	8
SYNTHETIC	NYLON, ACRYLIC, POLYESTER	40°C (COLD 30°C) (60°C)	PRE-WASH RINSE+ CREASE CARE	2
DELICATE	DELICATE, EASILY DAMAGED LAUNDRY SUCH AS SILK	COLD (30°C ,40°C)	RINSE+ CREASE CARE	2
WOOL	MACHINE WASHABLE PURE NEW WOOL ONLY.	COLD (30°C ,40°C)	RINSE+ CREASE CARE	2
HAND WASH	LAUNDRY MARKED "HAND WASH" AND WOOL BLENDS	COLD (30°C)	RINSE+ CREASE CARE	2
QUICK WASH	LIGHTLY SOILED COLOURFAST FABRICS UP TO 2KG DEPENDING ON SOILING.	30°C (COLD, 40°C)	RINSE+ CREASE CARE	2

- **Pre-Wash:** A Pre-Wash programme is recommended if laundry is heavily soiled. The Pre-Wash option is available for Cotton, Eco and Synthetic programmes.
- **Rinse+:** Use the Rinse+ option to add an additional rinse to the wash cycle. This will assist in removing any residual traces of detergent.
- **Eco:** Selecting the Eco option will lower the wash temperature and increase the washing time. A meaningful saving in electricity consumption is hereby achieved.
- **Quick Wash:** The Quick Wash option reduces the wash time and is only suitable for lightly soiled clothing which needs freshening.



# Programmes

## COTTON PROGRAMME

1	Place the laundry in the wash drum and close the door. Add detergent and softener to the detergent compartment as required. Should you wish to use bleach, add the bleach to the main wash compartment of the detergent drawer.
2	Open the water tap. Press the Power button. The display shows '—' and all the programme lights switch on
3	The Cotton programme may be selected using the programme selector knob. Wash temperature (40°C), Spin speed (800rpm) and 3 rinses are selected automatically. Should you wish to change the temperature, the spin speed, or add wash options, press the relevant button.
4	Press the start /hold button. (If you omitted step3, pressing the Start /Hold button would automatically select the default cotton programme). The door locks and the machine will then complete the selected wash cycle.

### NOTE

- Should you wish to change the setting during operation, press the Start/Hold button to hold the operation and then press the relevant button for the changes you wish to make.
- COLD, 40°C, 60°C and 95°C wash temperatures are selectable with the Cotton programme.
- Pre-Wash, Rinse+, and Crease Care are selectable wash options with the Cotton programme.

### AUTOMATIC SELECTION

**The cotton programme is automatically selected when the machine is switched on.**

### For MANUAL SELECTION which allows the customisation of programmes:

1. Switch the water tap on , add detergent and load the washing. Close the door.
2. Press the Power on button to start
3. Select the programme, temperature, spin speed and any option buttons you desire.
4. Press the Start/Hold button
5. The selected programme is displayed.

### CAUTION

- If you select 95°C, the machine will add some cold water before draining the main wash. This lowers the wash temperature and protects the user from touching a wash load that is too hot to handle.

# Programmes

## ECO PROGRAMME

1	Place the laundry in the wash drum and close the door. Add detergent and softener to the detergent compartment as required. Should you wish to use bleach, add the bleach to the main wash compartment of the detergent drawer.
2	Open the water tap. Press the Power button. The display shows '—' and all the programme lights switch on
3	The ECO programme may be selected using the programme selector knob. Wash temperature (60°C), Spin speed (800rpm) and 3 rinses are selected automatically. Should you wish to change the spin speed, or add wash options, press the relevant button.
4	Press the start /hold button. The door locks The machine will now sense the weight of the wash load and start washing accordingly.

### NOTE

- Should you wish to change the setting during operation, press the Start/Hold button to hold the operation and then press the relevant button for the changes you wish to make.
- Only 60°C wash temperatures is selectable with the ECO programme.
- Only Rinse+, and Crease Care are selectable wash options with the ECO programme.
- Use a lesser dosage of detergent if the ECO programme is used frequently. Ensure that you do not overdose with detergent as the ECO programme may not dissolve all the detergent. It is advisable to do a maintenance wash or "boil out" once a month if you use your machine frequently. If you use your machine less frequently then a maintenance wash 3 to 4 times a year should be sufficient. Please proceed as follows:

- 1) Dose your machine with a standard dose of detergent, or use 100 grams of Sunlight Dishwasher detergent, NOT WASHING SODA
- 2) Programme the machine to the longest, hottest wash.
- 3) Without loading any washing, allow the machine to run through the full cycle.

Defy recommends the use of Skip or Omo Auto concentrated liquid detergent when using the ECO programme - these dissolve rapidly and rinse out easily from the clothes.

# Programmes

## SYNTHETIC PROGRAMME

1	Place the laundry in the wash drum and close the door. Add detergent and softener to the detergent compartment as required. Should you wish to use bleach, add the bleach to the main wash compartment of the detergent drawer.
2	Open the water tap. Press the Power button. The display shows '—' and all the programme lights switch on
3	The Synthetic programme may be selected using the programme selector knob. Wash temperature (40°C), Spin speed (800rpm) and 3 rinses are selected automatically. Should you wish to change the temperature, the spin speed, or add wash options, press the relevant button.
4	Press the start /hold button. The door locks The machine will now sense the weight of the wash load and start washing accordingly.

### NOTE

- Should you wish to change the setting during operation, press the Start/Hold button to hold the operation and then press the relevant button for the changes you wish to make.
- Only COLD, 40°C, and 60°C wash temperatures are selectable with the Synthetic programme.
- Pre-Wash, Rinse+, and Crease Care are selectable wash options with the Synthetic programme.

# Programmes

## DELICATE PROGRAMME

1	Place the laundry in the wash drum and close the door. Add detergent and softener to the detergent compartment as required. Should you wish to use bleach, add the bleach to the main wash compartment of the detergent drawer.
2	Open the water tap. Press the Power button. The display shows '—' and all the programme lights switch on
3	The Delicate programme may be selected using the programme selector knob. Wash temperature (COLD), Spin speed (400rpm) and 2 rinses are selected automatically. Should you wish to change the spin speed, or add wash options, press the relevant button.
4	Press the start /hold button. The door locks and the machine will then complete the selected wash cycle.

### NOTE

- Should you wish to change the setting during operation, press the Start/Hold button to hold the operation and then press the relevant button for the changes you wish to make.
- Only COLD, 30°C, and 40°C wash temperatures are selectable with the Delicate programme.
- 1000rpm and 1400 rpm spin speeds are not available for selection with the Delicate programme
- Only Rinse+, and Crease Care are selectable wash options with the Cotton programme.

# Programmes

## WOOL PROGRAMME

1	Place the laundry in the wash drum and close the door. Add detergent and softener to the detergent compartment as required. Should you wish to use bleach, add the bleach to the main wash compartment of the detergent drawer.
2	Open the water tap. Press the Power button. The display shows '—' and all the programme lights switch on
3	The Wool programme may be selected using the programme selector knob. Wash temperature (COLD), Spin speed (400rpm) and 2 rinses are selected automatically. Should you wish to change the spin speed, or add wash options, press the relevant button.
4	Press the start /hold button. The door locks and the machine will then complete the selected wash cycle.

### NOTE

- Should you wish to change the setting during operation, press the Start/Hold button to hold the operation and then press the relevant button for the changes you wish to make.
- Only COLD, 30°C and 40°C wash temperatures are selectable with the Wool programme.
- Only Rinse+, and Crease Care are selectable wash options with the Wool programme.

### CAUTION

- Use only a detergent formulated for wool washing in automatic washing machines
- These detergents generate a large amount of soap suds so reduce the normal amount accordingly.

# Programmes

## HAND WASH PROGRAMME

1	Place the laundry in the wash drum and close the door. Add detergent and softener to the detergent compartment as required. Should you wish to use bleach, add the bleach to the main wash compartment of the detergent drawer.
2	Open the water tap. Press the Power button. The display shows '—' and all the programme lights switch on
3	The Hand Wash programme may be selected using the programme selector knob. Wash temperature (COLD), Spin speed (400rpm) and 3 rinses are selected automatically. Should you wish to change the spin speed, or add wash options, press the relevant button.
4	Press the start /hold button. The door locks and the machine will then complete the selected wash cycle.

### NOTE

- Should you wish to change the setting during operation, press the Start/Hold button to hold the operation and then press the relevant button for the changes you wish to make.
- Only COLD, and 30°C wash temperatures are selectable with the Hand Wash programme.
- 1000rpm and 1400 rpm spin speeds are not available for selection with the Hand Wash programme
- Only Rinse+, and Crease Care are selectable wash options with the Hand Wash programme.

### CAUTION

- Use the Hand Wash programme for garments marked "HAND WASH ONLY"

# Programmes

## QUICK 30 PROGRAMME

1	Place the laundry in the wash drum and close the door. Add detergent and softener to the detergent compartment as required. Should you wish to use bleach, add the bleach to the main wash compartment of the detergent drawer.
2	Open the water tap. Press the Power button. The display shows '—' and all the programme lights switch on
3	The Quick programme may be selected using the programme selector knob. Wash temperature (30°C ), Spin speed (800rpm) and 2 rinses are selected automatically. Should you wish to change the washing temperature, spin speed, or add wash options, press the relevant button.
4	Press the start /hold button. The door locks and the machine will then complete the selected wash cycle.

### NOTE

- Should you wish to change the setting during operation, press the Start/Hold button to hold the operation and then press the relevant button for the changes you wish to make.
- Only COLD, 30°C and 40°C wash temperatures are selectable with the Quick programme.
- 1000rpm and 1400 rpm spin speeds are not available for selection with the Quick programme
- Only Rinse+, and Crease Care are selectable wash options with the Quick programme.

### CAUTION

- Use the Quick programme for garments that are only slightly soiled and only require freshening.

## SPIN ONLY

1	Place the laundry in the wash drum and close the door.
2	Open the water tap. Press the Power button. The display shows '—' and all the programme lights switch on
3	Select the spin speed by pressing the Spin speed button
4	Press the start /hold button. The door locks and the machine will then complete the selected Spin cycle.

# Maintenance

## CLEANING THE DETERGENT DRAWER

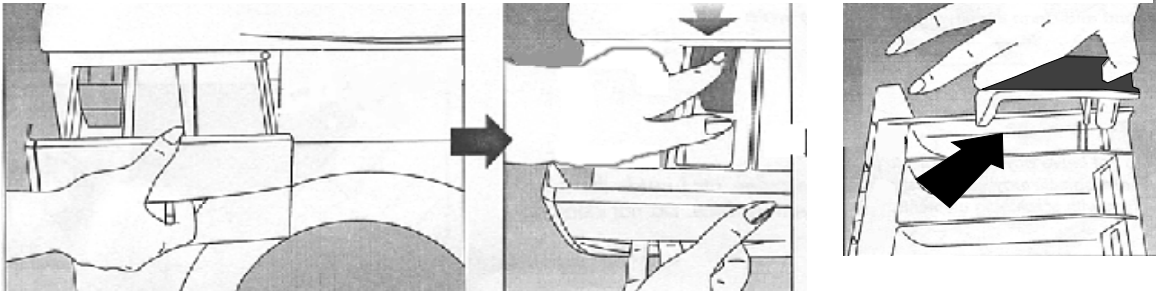

- To remove residual detergent, pull the dispenser drawer outward, press on the marked area of the siphon, and pull the drawer free.
- To facilitate cleaning, the upper part of the fabric softener compartment may be removed.
- Wash the dispenser in warm water.
- Remove any accumulated detergent from the housing recess using a small brush.
- Replace the drawer.

## CLEANING THE WATER INLET FILTER

- Water intake filters are located at the machine inlet valve and at the tap end of the inlet hose. These filters prevent dirt from entering the machine and should be cleaned periodically. (every 30 to 40 washes.)
- Close the tap and disconnect the inlet hose.
- Clean the filters with a bristle brush.
- If the filter is very dirty it may have to be pried loose with a pair of pliers.

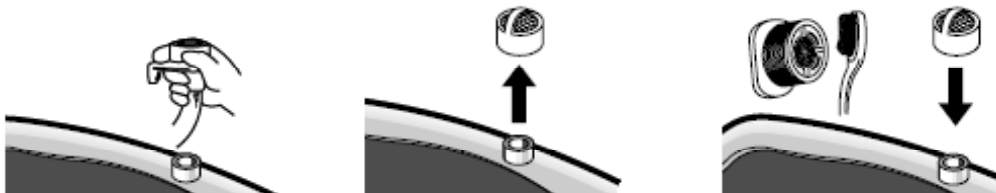

## CLEANING THE PUMP FILTER

- The filter prevents foreign objects from entering and damaging the pump. This filter should be cleaned after every 30-40 washes.
- First disconnect the machine from the power supply.
- Using a coin, open the filter cover located at the lower front of the machine.
- Pull the small hose partially out, remove the small plug at the end of the hose and empty the drain water into a suitable receptacle placed on the floor below the hose. When all the drain water has discharged, replace the plug and feed the hose back into the machine.
- Unscrew and remove the filter. Some residual water may leak onto the filter cover.
- Remove any debris and clean the filter before replacing it.
- Mop up any spillage and close the filter cover.

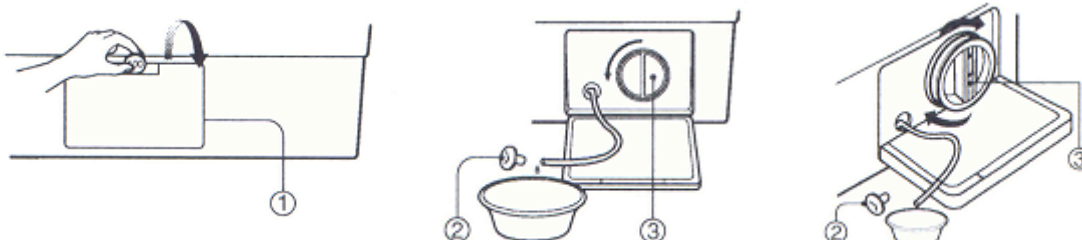



# Cleaning

## CLEANING THE EXTERIOR

- Wipe up any residual detergent , bleach and other spills as they occur.
- Periodically wipe the outside of the machine with a damp soft cloth.

## CLEANING THE INTERIOR

- Clean the interior with 250ml of chlorine bleach mixed with 500ml of detergent.
- Run the machine through a complete cycle.
- Repeat if necessary.

## HOLIDAY STORAGE

- If you are going to be away from home for some time:
- Close the tap
- Remove the power plug from the wall socket
- Disconnect the drain and inlet hoses
- Leave the door slightly open to prevent unpleasant odours from forming.

## International fabric care labels



**Recommended washing temp.**



**No dry cleaning**



**Bleach can be used**



**No spin**



**Do not use bleach**



**May be washed in**



**Wash by hand only**

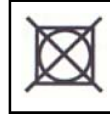

**Do not wash in centrifuge**

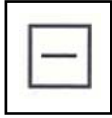

**Dry on horizontal surface**



**Line dry**



**Do not wash**

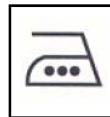

**Ironing is permitted**



**Dry clean**

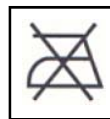

**Do not iron**



**Chemicals can be used**



**Use a warm iron only**

# Stain removal guide

- Stained, heavily soiled or greasy laundry may need to be pre-washed or soaked.
- Pre-washing helps loosen soil before washing.
- Soaking helps remove protein type stains like blood, milk or grass.
- Hot water can set stains and should not be used .
- Pre-clean the stain if possible by placing the garment face down on a paper towel or clean cloth. Apply a recommended stain remover to the back of the stain to force the stain away from the garment and not through it.
- Ascertain the type and age of the stain before attempting to clean it.
- Always check the garment care label to confirm that the chosen cleaning method is compatible.
- Washing and drying can set some stains.
- Only use bleach if it is recommended for the fabric type.
- Most stains are easier to remove if they are fresh.

STAIN	REMOVAL METHOD
<b>Blood.</b>	Rinse immediately and then soak in cold water with an enzyme based detergent before washing in cold water.
<b>Cocoa , Chocolate.</b>	Rinse immediately and then soak in cold water with an enzyme based detergent before washing in cold water.
<b>Chewing gum.</b>	Use ice to harden the gum scrape off and clean the remainder with white spirits.
<b>Coffee.</b>	Blot up and rinse in cold water. Rub a little liquid detergent on the stain and wash at the maximum temperature allowed for that fabric.
<b>Cream, Milk, Ice cream.</b>	Rinse in cold water and wash normally. If the stain persists, sponge with white spirits.
<b>Deodorant.</b>	Rub the affected area with vinegar and rinse under running cold water. Sponge with white spirits. Treat stiffened areas with an enzyme based pre-wash.
<b>Egg.</b>	Soak in an enzyme based pre-wash, rinse and wash normally.
<b>Fruit stains.</b>	Blot up and rinse in cold water. Rub a little liquid detergent on the stain and wash normally.
<b>Grass.</b>	Sponge with white spirits. Rub a little liquid detergent on the stain and wash normally.
<b>Grease, Oil.</b>	Lay affected area face down on an absorbent cloth and work from the back of the fabric. Sponge with white spirits or dry cleaning fluid. Wash normally.
<b>Iron rust.</b>	Apply lemon juice and salt. Lay face up in the sun to dry.. Wash normally.
<b>Lipstick.</b>	Sponge with white methylated spirits and wash normally.
<b>Mildew.</b>	Moisten area with lemon juice. Lay face up in the sun to dry. Wash normally using a little bleach if stain has persisted.
<b>Mud.</b>	Brush off any dry mud. Rinse in cold water. Rub a little detergent on the stain and wash normally.
<b>Paint , oil based.</b>	Scrape off any fresh paint and sponge with a non flammable dry cleaning fluid. Wash normally.
<b>Paint, water based.</b>	Treat while still wet, rinse in warm water and wash normally.
<b>Scorch marks.</b>	Dampen a cloth with hydrogen peroxide and lay it over the affected area. Press with a fairly hot iron.
<b>Fabric softener.</b>	Rub affected area with a bar of soap and wash normally.

# Problem washing—Check list

## GREASY STAINS ON WASHING

- Use more detergent if washing is heavily soiled.
- Use both pre-wash and main wash programmes.
- Check that the machine is not overloaded.

## GREY DIRTY LOOKING WASHING

- Use more detergent if the washing is heavily soiled or if the machine is located in a hard water area.
- Use pre-wash and main wash programmes.
- Check that the machine is not overloaded.

## POOR WASH RESULTS

- Read the instruction book carefully.
- Follow the manufacturer's instructions on the detergent pack.
- Sort out fabric types and separate natural from synthetic fabrics.
- Select the appropriate wash programme.
- Use fabric softeners for extra softness.
- Check that the machine is not overloaded.

## DISCOLOURING

- This could be caused by natural body oils or iron deposits in the water supply.
- Select the correct programme at the correct temperature.
- Use the correct detergent dosage.
- Wash the garment to the manufacturer's directions.
- Check that the machine is not overloaded.

## UNDISSOLVED DETERGENT IN THE ECO PROGRAMME

Use a lesser dosage of detergent if the ECO programme is used frequently. Ensure that you do not overdose with detergent as the ECO programme may not dissolve all the detergent. (See page 10)

# Trouble shooting

Most problems are easily solved if the cause is understood.

The machine has a self diagnostic capability and will, where possible display an error code if a problem is detected. Please check the following before calling a service technician to assist.

The washer will not operate at all.

Is there a power supply to the machine? Check the socket with another appliance such as a kettle Did you press the 'Start / Pause' button?

Has the machine been loaded with the correct amount of laundry?

Water is not supplied  
Error display is...



Is the tap open, the inlet hose connected and the filters clean?

Is the water frozen in the tap or hose?

Has the water supply been shut off?

Is the inlet hose blocked or kinked?

The washer will not drain  
Error display is...



Is the drain hose blocked, kinked or deformed?

Is the end of the drain hose immersed in water?

Has the pump filter been cleaned?

The washer will not spin.  
Error display is...



Is the wash load evenly distributed in the drum?

Is the door open ? The error code **UE** will be displayed.

The machine vibrates or is  
excessively noisy

Has the machine been levelled?

Have the transport fittings been removed?

Error display is...



Contact the nearest service centre.

The machine stops during the spin cycle or  
the spinning result is unsatisfactory.

Error display is



Are the filters or the drain pump clogged?

Is the drain pump operating?

Was the correct amount of detergent used?

Is the drain hose outlet higher than 1 metre above the floor?

To cancel the error display **PFE**, press the POWER OFF button, press the POWER ON button press the SPIN button and lastly press the START/HOLD button.

# Specifications

Model	DAW327
Dimensions (mm)	595 x 610 x 850 (W x D x H)
Maximum load ( textiles)	8.0
Machine Weight (Kg.)	54 (Net) / 58 (Gross)
Standard water consumption (l)	52
Spin Speed (RPM)	400 / 800 / 1000 / 1400
Operating water pressure	0.03MPa—0.8MPa

# Wiring Diagram

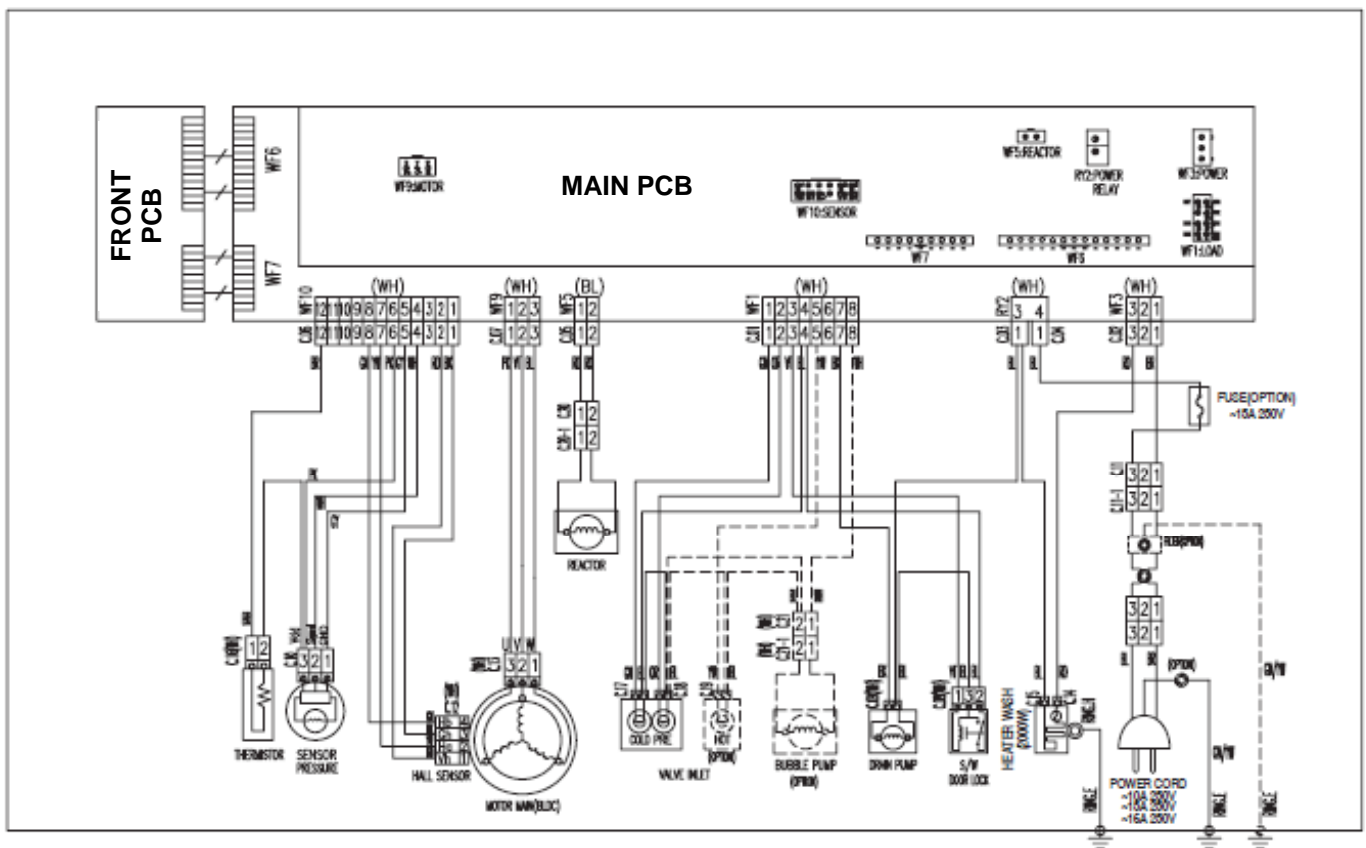

# Owner's responsibility

Please note that the following are not covered by the warranty.

- Damage to exterior finish.
- Breakage of the door glass.
- Damage through improper installation.
- Damage caused through improper use of the appliance.
- Damage caused by moving or transporting the appliance.

## Service centres

If you have followed the instructions and still have a problem, contact the nearest Defy Service Centre. They will be able to advise you on any aspect of the product or send a qualified technician to repair it.

**BLOEMFONTEIN** 160 Long Street, Hilton,  
Bloemfontein 9301.  
Tel. 051 400 3900  
[Bloemfontein.Service@defy.co.za](mailto:Bloemfontein.Service@defy.co.za)

**CAPE TOWN** 5A Marconi Rd.  
Montague Gardens, 7441.  
Tel. 021 526 3000  
[CapeTown.Service@defy.co.za](mailto:CapeTown.Service@defy.co.za)

**DURBAN** 35 Intersite Avenue,  
Umgeni Business Park, Durban 4051.  
Tel. 031 268 3300  
[Durban.Service@defy.co.za](mailto:Durban.Service@defy.co.za)

**EAST LONDON** 16 Bowls Rd. Arcadia,  
East London 5201.  
Tel. 043 743 7100  
[EastLondon.Service@defy.co.za](mailto:EastLondon.Service@defy.co.za)

**JOHANNESBURG** Cnr. Mimetes & Kruger Sts. Denver ext.12  
Commercial Head Office,  
Administration, Distribution, National  
Groups, Tel. Sales, Contracts and Credit. Johannesburg. 2094.  
Tel. 011 621 0200 or 011 621 0300  
[Gauteng.Service@defy.co.za](mailto:Gauteng.Service@defy.co.za)

**POLOKWANE** 87 Nelson Mandela Drive.  
Superbia 0699.  
Tel. 0152 92 1166 / 7 / 8 / 9.  
[Polokwane.Service@defy.co.za](mailto:Polokwane.Service@defy.co.za)

**PORT ELIZABETH** 112 Patterson Road,  
North End, Port Elizabeth 6001.  
Tel. 041 401 6400  
[PortElizabeth.Service@defy.co.za](mailto:PortElizabeth.Service@defy.co.za)

**PRETORIA.** Block A1 Old Mutual Industrial Park.  
Cnr. D.F.Malan Drive & Moot Str.  
Hermanstad. 0082.  
Tel. 012 377 8300  
[Pretoria.Service@defy.co.za](mailto:Pretoria.Service@defy.co.za)

**OTHER AREAS ARE SERVICED BY OVER 200 AUTHORISED SERVICE AGENTS.  
PLEASE CONSULT THE NEAREST REGIONAL DEFY SERVICE CENTRE FOR DETAILS.**

# Warranty

This certificate is issued by DEFY APPLIANCES (PTY) LIMITED manufacturers of Defy and Ocean products, hereinafter the Company, to the original purchaser only, of the appliance described on the certificate and shall constitute the only warranty given in respect of this appliance.

The Company warrants to the original purchaser that for a period of **TWO YEARS** from date of purchase the appliance is free from defect under normal domestic use, both in workmanship and material, subject to the following conditions.

**1.** Repair or replacement of any part of this appliance, found by the Company to be defective, shall be at the election of the Company. The Company reserves the right to effect such service through any of its Service Divisions or Authorised Service Dealers. The cost of such service shall be borne by the Company in full, provided that the appliance is located no further than 50 km. from a Company Service Centre or an Authorised Service Dealer. Where the appliance is located beyond the 50 km. radius, the purchaser shall be liable for the standard travelling charges, as determined by the Company.

**CARRY IN SERVICE** Microwave ovens, Compact cookers and small appliances are repaired in our service centres and are not collected from the customers home. Faulty units should be delivered to the purchasing dealer or to the nearest Company Service Centre for warranty repairs.

**2.** Vitreous enamelware, fuses and lamps are specifically excluded from these warranties. It is an express condition of these warranties that the purchaser takes due care and attention in the use and maintenance of the appliance. Abuse, misuse in conflict with operating instructions, connection to incorrect voltages and subjection to commercial use shall release the Company from its obligations.

**3.** This warranty shall become void and cease to operate if the appliance is dismantled by, or any repairs to the appliance are effected by any persons not duly authorised by the Company, or if substitute parts not approved by the Company are used in the appliance, or if the serial number of the appliance is removed.

**4.** The Company shall not be responsible for damages resulting from fire, flood, civil disturbances or any Act of God. The Company shall not, in terms of these warranties be responsible nor held liable for any consequential loss or damage of any kind caused by or due to the failure or malfunction of the appliance.

**5.** The Company shall not be responsible for transportation or other costs other than those incurred within the provisions of Point 1 of this Certificate.

**6.** These warranties shall not apply to the appliance if it is purchased or used beyond the borders of the Republic of South Africa, Namibia, Botswana, Swaziland and Lesotho.

**7.** Where service is requested under warranty and no fault or defect can be found by the Company, all costs incurred will be for the purchaser's account.

**8.** This Certificate as well as your invoice will serve as proof of purchase. For the purpose of warranty, it will be essential to produce this Certificate and invoice. Failure to do so, will render the purchaser liable for service costs.

**KEEP THIS CERTIFICATE AND SALES INVOICE AS PROOF OF PURCHASE FOR WARRANTY PURPOSES.**

# Notes





You can rely on Defy. To simplify

## OWNER'S MANUAL

**MAXIMAID 800**  
**DAW 327(Metallic)**  
**DAW 328 (White)**



**Automatic Washing Machine**

The Manufacturer strives for continuous improvements.  
The content of this book is therefore subject to change without notice.

Record in the space below the listed information for future reference. The Serial number may be found on the rating label at the rear of the machine

SERIAL No.....

DATE OF PURCHASE.....

PURCHASED FROM.....





## Free Manuals Download Website

<http://myh66.com>

<http://usermanuals.us>

<http://www.somanuals.com>

<http://www.4manuals.cc>

<http://www.manual-lib.com>

<http://www.404manual.com>

<http://www.luxmanual.com>

<http://aubethermostatmanual.com>

Golf course search by state

<http://golfingnear.com>

Email search by domain

<http://emailbydomain.com>

Auto manuals search

<http://auto.somanuals.com>

TV manuals search

<http://tv.somanuals.com>