

dbx[®] *PROFESSIONAL PRODUCTS*

DriveRack[®]

Powered Speaker Optimizer

PX



Featuring



Powered Speakers

User Manual

IMPORTANT SAFETY INFORMATION



CAUTION

RISK OF ELECTRIC SHOCK
DO NOT OPEN



ATTENTION: RISQUE DE CHOQUE ELECTRIQUE - NE PAS OUVRIR

WARNING: TO REDUCE THE RISK OF FIRE OR ELECTRIC SHOCK DO NOT EXPOSE THIS EQUIPMENT TO RAIN OR MOISTURE

The symbols shown above are internationally accepted symbols that warn of potential hazards with electrical products. The lightning flash with arrowpoint in an equilateral triangle means that there are dangerous voltages present within the unit. The exclamation point in an equilateral triangle indicates that it is necessary for the user to refer to the owner's manual.

These symbols warn that there are no user serviceable parts inside the unit. Do not open the unit. Do not attempt to service the unit yourself. Refer all servicing to qualified personnel. Opening the chassis for any reason will void the manufacturer's warranty. Do not get the unit wet. If liquid is spilled on the unit, shut it off immediately and take it to a dealer for service. Disconnect the unit during storms to prevent damage.

SAFETY INSTRUCTIONS

NOTICE FOR CUSTOMERS IF YOUR UNIT IS EQUIPPED WITH A POWER CORD.

WARNING: THIS APPLIANCE SHALL BE CONNECTED TO A MAINS SOCKET OUTLET WITH A PROTECTIVE EARTHING CONNECTION.

The cores in the mains lead are coloured in accordance with the following code:

GREEN and YELLOW - Earth BLUE - Neutral BROWN - Live

As colours of the cores in the mains lead of this appliance may not correspond with the coloured markings identifying the terminals in your plug, proceed as follows:

- The core which is coloured green and yellow must be connected to the terminal in the plug marked with the letter E, or with the earth symbol, or coloured green, or green and yellow.
- The core which is coloured blue must be connected to the terminal marked N or coloured black.
- The core which is coloured brown must be connected to the terminal marked L or coloured red.

This equipment may require the use of a different line cord, attachment plug, or both, depending on the available power source at installation. If the attachment plug needs to be changed, refer servicing to qualified service personnel who should refer to the table below. The green/yellow wire shall be connected directly to the units chassis.

CONDUCTOR		WIRE COLOR	
		Normal	Alt
L	LIVE	BROWN	BLACK
N	NEUTRAL	BLUE	WHITE
E	EARTH GND	GREEN/ YEL	GREEN

WARNING: If the ground is defeated, certain fault conditions in the unit or in the system to which it is connected can result in full line voltage between chassis and earth ground. Severe injury or death can then result if the chassis and earth ground are touched simultaneously.

WARNING FOR YOUR PROTECTION PLEASE READ THE FOLLOWING:

KEEP THESE INSTRUCTIONS

HEED ALL WARNINGS

FOLLOW ALL INSTRUCTIONS

THE APPARATUS SHALL NOT BE EXPOSED TO DRIPPING OR SPLASHING LIQUID AND NO OBJECT FILLED WITH LIQUID, SUCH AS VASES, SHALL BE PLACED ON THE APPARATUS

CLEAN ONLY WITH A DRY CLOTH.

DO NOT BLOCK ANY OF THE VENTILATION OPENINGS. INSTALL IN ACCORDANCE WITH THE MANUFACTURER'S INSTRUCTIONS.

DO NOT INSTALL NEAR ANY HEAT SOURCES SUCH AS RADIATORS, HEAT REGISTERS, STOVES, OR OTHER APPARATUS (INCLUDING AMPLIFIERS) THAT PRODUCE HEAT.

ONLY USE ATTACHMENTS/ACCESSORIES SPECIFIED BY THE MANUFACTURER.

UNPLUG THIS APPARATUS DURING LIGHTNING STORMS OR WHEN UNUSED FOR LONG PERIODS OF TIME.

Do not defeat the safety purpose of the polarized or grounding-type plug. A polarized plug has two blades with one wider than the other. A grounding type plug has two blades and a third grounding prong. The wide blade or third prong are provided for your safety. If the provided plug does not fit your outlet, consult an electrician for replacement of the obsolete outlet.

Protect the power cord from being walked on or pinched particularly at plugs, convenience receptacles, and the point where they exit from the apparatus.

Use only with the cart stand, tripod bracket, or table specified by the manufacture, or sold with the apparatus. When a cart is used, use caution when moving the cart/apparatus combination to avoid injury from tip-over.



Refer all servicing to qualified service personnel. Servicing is required when the apparatus has been damaged in any way, such as power-supply cord or plug is damaged, liquid has been spilled or objects have fallen into the apparatus, the apparatus has been exposed to rain or moisture, does not operate normally, or has been dropped.

MAINS DISCONNECT: The plug shall remain readily operable. For rack-mount or installation where plug is not accessible, an all-pole mains switch with a contact separation of at least 3 mm in each pole shall be incorporated into the electrical installation of the rack or building.

FOR UNITS EQUIPPED WITH EXTERNALLY ACCESSIBLE FUSE RECEPTACLE: Replace fuse with same type and rating only.

MULTIPLE-INPUT VOLTAGE: This equipment may require the use of a different line cord, attachment plug, or both, depending on the available power source at installation. Connect this equipment only to the power source indicated on the equipment rear panel. To reduce the risk of fire or electric shock, refer servicing to qualified service personnel or equivalent.

IMPORTANT SAFETY INFORMATION

ELECTROMAGNETIC COMPATIBILITY

This unit conforms to the Product Specifications noted on the **Declaration of Conformity**. Operation is subject to the following two conditions:

- this device may not cause harmful interference, and
- this device must accept any interference received, including interference that may cause undesired operation.

Operation of this unit within significant electromagnetic fields should be avoided.

- use only shielded interconnecting cables.

U.K. MAINS PLUG WARNING

A molded mains plug that has been cut off from the cord is unsafe. Discard the mains plug at a suitable disposal facility.

NEVER UNDER ANY CIRCUMSTANCES SHOULD YOU INSERT A DAMAGED OR CUT MAINS PLUG INTO A 13 AMP POWER SOCKET.

Do not use the mains plug without the fuse cover in place. Replacement fuse covers can be obtained from your local retailer. Replacement fuses are 13 amps and **MUST** be ASTA approved to BS1362.



If you want to dispose this product, do not mix it with general household waste. There is a separate collection system for used electronic products in accordance with legislation that requires proper treatment, recovery and recycling.

Private household in the 25 member states of the EU, in Switzerland and Norway may return their used electronic products free of charge to designated collection facilities or to a retailer (if you purchase a similar new one).

For Countries not mentioned above, please contact your local authorities for a correct method of disposal.

By doing so you will ensure that your disposed product undergoes the necessary treatment, recovery and recycling and thus prevent potential negative effects on the environment and human health.

DECLARATION OF CONFORMITY

Manufacturer's Name: dbx Professional Products
Manufacturer's Address: 8760 S. Sandy Parkway
Sandy, Utah 84070, USA

declares that the product:

Product name: DriveRack PX
Note: Product name may be suffixed by the EU.

Product option: None

conforms to the following Product Specifications:

Safety: IEC 60065 (7th ed. 2001)

EMC: EN 55013 (2001+A1)
EN 55020 (1998)

Supplementary Information:

The product herewith complies with the requirements of the Low Voltage Directive 72/23/EEC and the EMC Directive 89/336/EEC as amended by Directive 93/68/EEC.

Director of Engineering - dbx
8760 S. Sandy Parkway
Sandy, Utah 84070, USA
Date: January 23, 2008

European Contact: Your local dbx Sales and Service Office or

Harman Music Group
8760 South Sandy Parkway
Sandy, Utah 84070, USA
Ph: (801) 566-8800
Fax: (801) 568-7583

Section 1- Introduction	1	Section A - Appendix.....	33
0.1 Defining the DriveRack PX.....	1	A.1 Factory Reset.....	33
0.2 Service Contact Info.....	2	A.2 Power Up Quick Key Options.....	33
0.3 Warranty.....	3	A.3 Specifications	35
Section 2- Getting Started	4	A.4 Auto-EQ Optimization Tips.....	36
2.1 Rear Panel Connections	4	A.5 Crossover Diagrams	36
2.2 Front Panel Connections	4	A.6 Block Diagram.....	37
2.3 Quick Start	6	A.7 Preset List / Supported Speakers	38
2.4 DriveRack PX Wizard.....	8	A.8 System Setup and Gain Structure.....	39
Section 3 - Editing Functions.....	15		
3.1 Basic Navigation Modes	15		
3.2 Button Array Overview.....	15		
3.3 Navigating the High-pass and Bandpass Filter (SETUP) Section	16		
3.4 Navigating the Subharmonic Section.....	16		
3.5 Navigating the Comp/Limiter Section.....	17		
3.6 Navigating the EQ Section	17		
3.7 Navigating the AFS Section	18		
3.8 Navigating the Utility Section	18		
3.9 Navigating the Wizard Section.....	18		
3.10 Navigating the Recall Section	19		
3.11 Navigating the Store Section	19		
Section 4 - Operating Functions.....	20		
4.1 Preset Definition	20		
4.2 Navigating Factory Presets	20		
4.3 Editing Factory Presets.....	21		
Section 5 - Detailed Parameters	23		
5.1 Stereo Input Graphic EQ	23		
5.2 AFS (Automatic Feedback Suppression).....	23		
5.3 Subharmonic Synthesizer	25		
5.4 Compressor/Limiter.....	26		
5.5 Filter (SETUP)	28		
5.6 Output Parametric EQ (3-band)	28		
Section 6 - Application Guide	29		
6.1 Mains-Only Setup (No Subs)	29		
6.2 Two Mains/One Subwoofer Setup.....	30		
6.3 Two Mains/Two Subwoofers Setup	31		
6.4 Sub with Satellites Setup.....	32		

Section 1- Introduction

The dbx DriveRack® PX Powered Speaker Optimizer has everything you need to get the most out of your stereo powered speaker system. It even includes stereo or mono subwoofer support. With the included dbx M2 measurement mic, Auto-EQ corrects for audible deficiencies in the room environment. Our patented Advanced Feedback Suppression (AFS™) kills nasty feedback, allowing problem-free operation at higher sound levels, while our patented Subharmonic Synthesizer™ extends bass response for enhanced bottom end. With all that, you also get classic dbx compression and the protection offered by our graceful PeakPlus™ limiting. Your ears, your audience, and your powered speakers will forever thank you.

0.1 Defining the DriveRack PX

The dbx DriveRack PX is the most effective way to manage all aspects of powered loudspeaker management for public address system applications. The DriveRack PX essentially becomes the only device that you will need between the mixer and the powered speakers. The following are just some of the features of the DriveRack PX.

DriveRack® PX features:

- Stereo Feedback Elimination with 12 feedback notch filters
- Stereo 28-band Graphic EQ
- Classic dbx® Compressor
- 120A Subharmonic Synthesizer
- Stereo Multi-band Parametric EQ
- Stereo PeakPlus™ Limiters
- Pink Noise Generator
- Auto-EQ™ with 28-Band RTA
- JBL® and other popular powered speakers included in Setup Wizard
- JBL® preset speaker combinations
- dbx M2 Measurement Mic and zippered pouch included
- Front panel RTA-Mic XLR input with phantom power
- 25 User Programs / 25 Factory Programs
- 2 Channel XLR Input
- 2 Channel XLR Output
- 2 Channel XLR Sub Output
- 24-Bit ADC/24-Bit DAC, >110 dB Dynamic Range
- dbx Type IV™ Conversion System
- Full Graphic LCD Display

By including every form of processing necessary to drive the signal from the mixer to the power amp, the DriveRack® PX allows you to eliminate all other processing devices normally found in large and cumbersome traditional drive rack systems of the past.

The DriveRack PX Powered Speaker Optimizer includes two balanced XLR inputs and two balanced XLR outputs, as well as two balanced XLR subwoofer output connectors.

0.2 Service Contact Info

If you require technical support, contact dbx Customer Service. Be prepared to accurately describe the problem. Know the serial number of your unit - this is printed on a sticker attached to the bottom panel. If you have not already taken the time to fill out your warranty registration card and send it in, please do so now.

Before you return a product to the factory for service, we recommend you refer to the manual. Make sure you have correctly followed installation steps and operation procedures. If you are still unable to solve a problem, contact our Customer Service Department at (801) 568-7660 for consultation. If you need to return a product to the factory for service, you **MUST** first contact Customer Service to obtain a Return Authorization Number.

No returned products will be accepted at the factory without a Return Authorization Number.

Please refer to the Warranty information on the following page, which extends to the first end-user. After expiration of the warranty, a reasonable charge will be made for parts, labor, and packing if you choose to use the factory service facility. In all cases, you are responsible for transportation charges to the factory. dbx will pay return shipping if the unit is still under warranty.

Use the original packing material if it is available. Mark the package with the name of the shipper and with these words in red: DELICATE INSTRUMENT, FRAGILE! Insure the package properly. Ship prepaid, not collect. Do not ship parcel post.

0.3 Warranty

This warranty is valid only for the original purchaser and only in the United States.

1. The warranty registration card that accompanies this product must be mailed within 30 days after purchase date to validate this warranty. Proof-of-purchase is considered to be the burden of the consumer.
2. dbx warrants this product, when bought and used solely within the U.S., to be free from defects in materials and workmanship under normal use and service.
3. dbx liability under this warranty is limited to repairing or, at our discretion, replacing defective materials that show evidence of defect, provided the product is returned to dbx WITH RETURN AUTHORIZATION from the factory, where all parts and labor will be covered up to a period of two years. A Return Authorization number must first be obtained from dbx by telephone. The company shall not be liable for any consequential damage as a result of the product's use in any circuit or assembly.
4. dbx reserves the right to make changes in design or make additions to or improvements upon this product without incurring any obligation to install the same additions or improvements on products previously manufactured.
5. The foregoing is in lieu of all other warranties, expressed or implied, and dbx neither assumes nor authorizes any person to assume on its behalf any obligation or liability in connection with the sale of this product. In no event shall dbx or its dealers be liable for special or consequential damages or from any delay in the performance of this warranty due to causes beyond their control.

Section 2- Getting Started

2.1 Rear Panel Connections

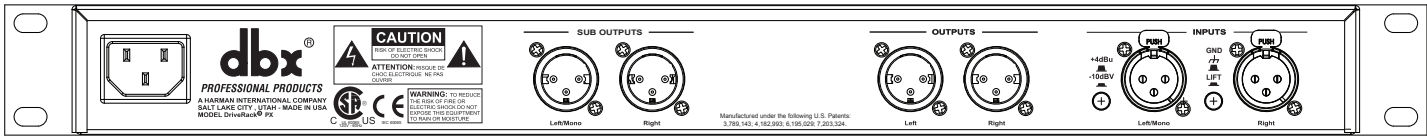

IEC Power Cord Receptacle

The DriveRack® PX comes with a power supply that will accept voltages ranging from 100V-120V at frequencies from 50Hz-60Hz. An IEC cord is included. EU versions accept 220V-240V at frequencies from 50Hz-60Hz.

Sub Outputs Left/Mono and Right

Connect your subwoofer(s) here (optional).

Outputs Left and Right

Connect your main speakers here.

Inputs Left/Mono and Right

The input section of the DriveRack PX offers two electronically balanced XLR connectors.

Ground Lift Switch

The ground lift switch lifts the pin 1 chassis ground of both input XLR connectors.

+4dBu / -10dBV Switch

This switch selects between -10dBV and +4dBu nominal operating levels. When the switch is in the "in" position, the -10dBV operating level is selected. When the switch is in the "out" position, +4dBu is selected.

2.2 Front Panel Connections

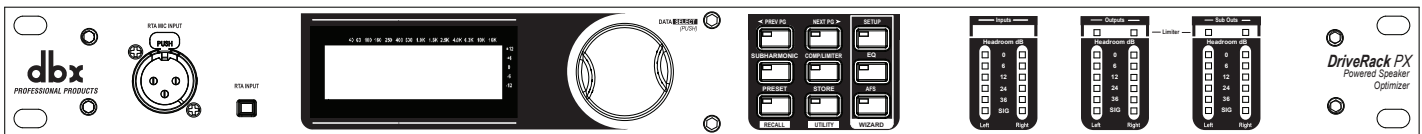

RTA Mic Input Jack

This balanced XLR input is used for the connection of the dbx M2 RTA microphone, which allows the user to optimize the powered speaker settings and the EQ settings of any room through the use of the System Setup and Auto-EQ Wizards.

RTA MIC Input Selector

Pressing the RTA MIC input button will engage the front panel RTA input XLR connector and start the Auto-EQ wizard.

Data Wheel

The Data wheel of the DriveRack® PX is used to scroll through the preset menu, load presets, select parameters and edit parameter values.

LCD Display

The backlit LCD display of the DriveRack® PX provides the user with all of the vital processing information of the DriveRack® PX including: signal routing, effect block editing and Wizard functions. The display will also notify the user if any internal clipping is taking place within the unit. The following message will appear: CLIP.

Function Buttons

The function buttons of the DriveRack® PX allow direct access to all editing and navigating functions of the DriveRack® PX. The functions of the aforementioned buttons are as follows:

<PREV PG> - Moves to the previous page in the currently selected menu.

<NEXT PG> - Moves to the next page in the currently selected menu.

<SETUP> - Press and release to enter the high-pass and bandpass filter editor. Press and hold to enter the first page of the Powered Speaker Setup Wizard.

<SUBHARMONIC> - Press and release to enter the dbx 120A Subharmonic Synthesizer editor.

<COMP/LIMITER> - Press and release to cycle through the compressor editor and output limiter processing editor.

<EQ> - Press and release to cycle through the graphic EQ and parametric EQ editors. Press and hold to enter the first page of the Auto-EQ Wizard.

<PRESET/[RECALL]> - Press and release to return to the preset view, showing preset number, preset bank (user or factory), preset name, and signal path. Press and hold to activate the [RECALL] button function which allows the selection and loading of a new preset.

<STORE/[UTILITY]> - Press and release to enter the Store menu, which allows the user to store the current state to a user preset. Press and hold to enter the UTILITY menu to adjust LCD contrast, Auto-EQ plot selection (RTA or GEQ), and Sales Banner on/off.

<AFS> - Press and release to enter the AFS editor. Press and hold to enter the first page of the AFS Wizard.

Stereo Input Meters

The DriveRack® PX provides the user with two independent six segment input meters that range from Signal Present (-48 dBFS) to 0 dBFS (maximum output). These meters monitor the signal level right after the input module.

Stereo Output Meters

The DriveRack® PX provides the user with two independent six-segment output meters that range from Signal Present to 0 dBFS (maximum output).

Mono/Stereo Subwoofer Output Meters

The DriveRack® PX provides the user with two independent six-segment subwoofer output meters that range from Signal Present to 0 dBFS (maximum output).

Threshold Meters

The threshold meters indicate that the threshold level has been exceeded within the Limiter section, and gain reduction may be taking place within the specific output channel.

2.3 Quick Start

For those of you that wish to jump right in, the following information has been provided to act as a quick start guide for optimizing performance of the DriveRack® PX.

Signal Path Block Diagram

The following diagram shows the logical and intuitive signal path of the input, signal processing modules, and output of the DriveRack® PX.

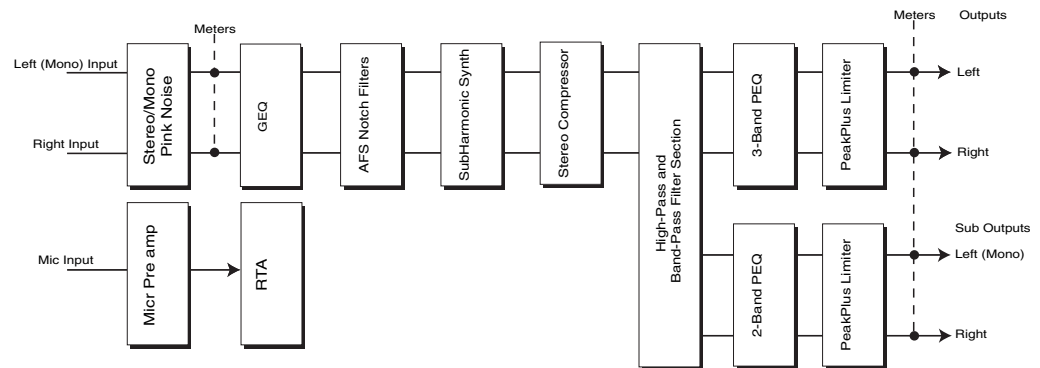

Connections

- When setting up the DriveRack® PX, make connections as follows:
- Always make connections prior to applying power to the unit.
- Connect the output from the sending device (mixer) to one or both of the two XLR input connectors shown below.
- Make output connections from “Outputs” XLR connectors shown below to the inputs of the powered speakers.
- If a subwoofer or subwoofers are to be used, make output connections from “Sub Outputs” XLR connectors shown below to the inputs of the subwoofers.

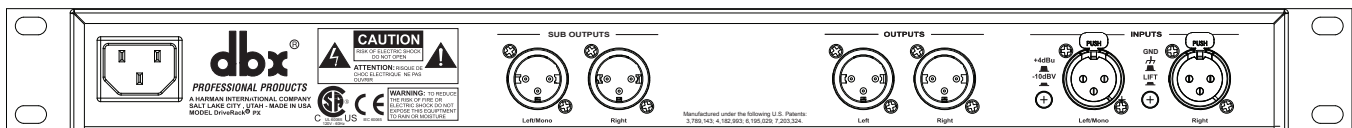

- If you will be “pinking” the room through the use of the RTA, connect the dbx M2 RTA microphone to the front-panel XLR input.
- **IMPORTANT- It is imperative that the powered speakers are turned off prior to applying power to the DriveRack® PX. Always make sure that your powered speakers are the last item turned on and the first turned off.**

Once all of the connections have been made and the unit is powered up, you can navigate through the entire signal path of the DriveRack PX from the front panel of the unit. The display provides you with a clear and concise overview of each aspect of the signal path from the input to the output section.

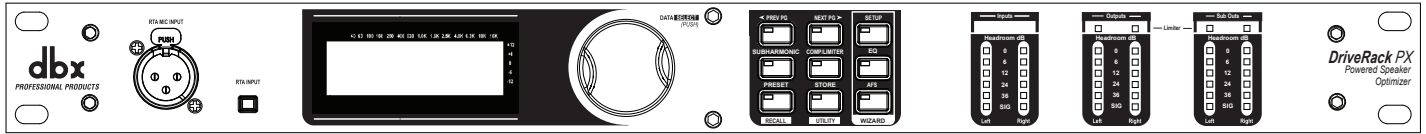

The features of the front panel of the DriveRack® PX are as follows from left to right.

RTA MIC Input - This XLR input is used for the connection of the dbx M2 RTA microphone (included). The RTA MIC input button is used to engage the RTA input connector.

LCD Display - All operational information of the DriveRack® PX is displayed here. The display will also notify the user if any internal clipping is taking place within the unit. The following message will appear: CLIP.

Data Wheel - The data wheel is used to scroll through the preset menu of the DriveRack® PX. The Data Wheel is also used to perform editing functions to signal processing and utility menu features.

Button Array - Operational editing is done using this 9 button array. A complete description of each button's functionality is listed on page 5.

Input meters - These two 6-segment LED meters monitor the input level of the DriveRack® PX directly after the input mixer.

Output Meters - These two 6-segment meters monitor the output levels of the DriveRack® PX directly after the output gain stage.

Subwoofer Output Meters - These two 6-segment meters monitor the subwoofer output levels of the DriveRack® PX directly after the output gain stage.

Threshold Meters - These four 1-segment meters indicate when the threshold levels of the limiters have been exceeded.

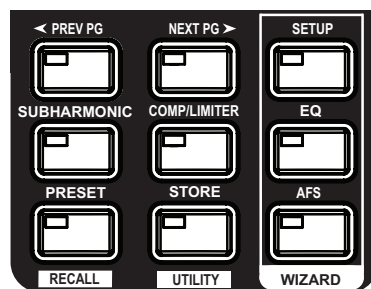

2.4 DriveRack PX Wizard

Now that you have made all of your audio connections and have made yourself familiar with the front-panel navigation of the unit, you can easily optimize your system through the use of the DriveRack® PX Wizards. These allow for quick and accurate venue setups. There are three wizards: Setup, EQ, and AFS. Press hold any button in the Wizard section of the front panel to access them. The wizards are designed to be used in sequence (from top to bottom), but can be used individually as well.

Before you use the wizards, make sure the controls on your powered speakers are set the same on both speakers. For example, if you're using subs, and they have a polarity setting, make sure they're both set to the same polarity. Also, if your powered speakers have a Mic/Line setting, make sure they're both set to Line, and if they have their own EQ settings, disable the EQ settings on the powered speakers.

The following section walks you through each of the wizards.

SETUP WIZARD

- From preset mode, press and hold the <SETUP> button and the display will appear as follows:

```

DriveRack PX
System Setup WIZARD
<NEXT PG> to advance
  
```

Press the <Next PG> button to continue.

- The display will appear as follows:

```

Input Setup
Select Input as MONO
or STEREO.
▶STEREO
  
```

- Simply rotate the <Data> wheel to select either a Mono or Stereo input configuration. Once you have selected your input option, press the <NEXT PG> button and the display will appear as follows:

```

Main Speakers
Select Speakers
JBL EON
▶EON10G2
  
```



- Rotate the <Data> wheel to select any one of the numerous MAIN speaker options available. If the speaker being used is not specified in the menu, select CUSTOM. (Note that you can scroll by category by pressing the Select knob and placing the arrow next to the category heading above the speaker name. Press the Select knob again to place the arrow next to the speaker name to scroll by speaker name.) Once you have selected your Main speaker option, press the <NEXT PG> button and the display will appear as follows:



- Rotate the <Data> wheel to select any one of the numerous SUB speaker options available. (Note that you can scroll by category by pressing the Select knob and placing the arrow next to the category heading above the speaker name. Press the Select knob again to place the arrow next to the speaker name to scroll by speaker name.) Once you have selected your SUB speaker option, press the <NEXT PG> button.
- You will now be given the option of optimizing your main speakers' levels with the DriveRack PX. The page will appear something like this:

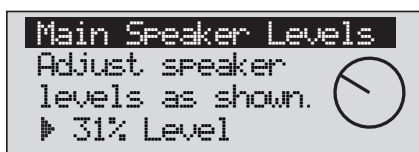

- Turn the volume (level) knob on each of your main powered speaker(s) to the position shown in this screen. When you've done this, press the <NEXT PG> button.
- If you're using sub speaker(s), you will now be given the option of optimizing your sub speakers' levels with the DriveRack PX. The page will appear something like this:

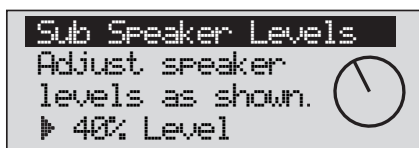

- Turn the volume (level) knob on each of your sub speakers to the position shown in this screen. When you've done this, press the <NEXT PG> button. (If you're not using sub speakers, this step will be skipped.)
- The display will now prompt you to load the preset you've just created.

```

Load New Preset
Press Select to Load

▶ New Preset

```

- Press the <Data> wheel to load the new preset. The display will look like this:

```

Auto Level
Connect mic to RTA
input. Press RTA
input button.

```

- The display is prompting you to connect an RTA-specific microphone to the front-panel RTA XLR input, and press the <RTA Input> button. It is recommended that you use the included dbx M2 RTA microphone, placed somewhere close to the middle of where your audience will be. (If you wish to manually balance the individual speaker levels by ear, you can skip the Auto Level portion of this wizard, by pressing the <Preset> button.) Once you've connected the RTA microphone and pressed the <RTA Input> button, the display will look like this:

```

Auto Level
Mic Level ██████████
Turn Up Level
Pink Level ▶ 18dB

```

- You will now proceed to "Pink" the room by adjusting the Pink level. The range of bar graph is -Inf dB to +20dB. Be certain to raise the pink noise level to the level of loudness intended during the performance. Once the Pink level has been adjusted to the desired volume, press the <Next Pg> button and the Auto Level sequence will begin. The DriveRack PX will adjust balance levels for your main speakers (and your subs, if you have them). Note that you may be prompted to readjust the your speaker knob settings. When the Auto Level sequence is finished, the display will look like this:

```

Auto Level Complete
Release RTA INPUT
button to exit.

```

- After you press the <RTA Input> button to release it, the display will look something like this:

```

EQN1092wSub Loaded
and levels balanced.
<NEXT PG>-Auto EQ
<PRESET>-Exit Wizard

```

Press the <Next PG> button to start the Auto-EQ wizard.

AUTO-EQ WIZARD

- Once you have completed the Setup wizard, you can now proceed to EQ your system. The Auto-EQ Wizard automatically adjusts the response of the system by producing pink noise and adjusting the Graphic EQ until the RTA matches a selected response. (The Auto-EQ™ Wizard can be initialized at any time by pressing and holding the <EQ> button.) The display will look like this:

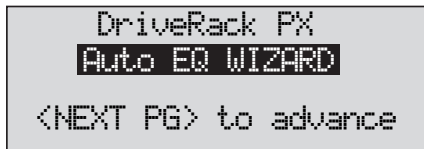

- Press the <NEXT PG> button and the display will read:



- The display is prompting you to connect an RTA-specific microphone to the front-panel RTA XLR input, and press the <RTA Input> button. It is recommended that you use the included dbx M2 RTA microphone. The display will appear something like this:

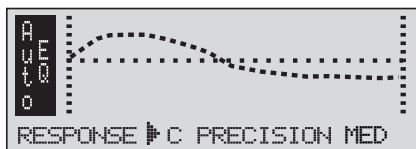

- You can now select any one of the several different Frequency responses for the Auto-EQ. The options are: Flat (0), and Responses A-D. You can also select Low, Medium and High Precision. Press the <Data Wheel> to toggle between selecting Response and Precision. Turn the <Data Wheel> to scroll through the available options. Once you have selected your desired EQ Frequency response, press the <Next pg> button and the display will appear as follows:



- You will now proceed to “Pink” the room by adjusting the Pink level. The range of bar graph is -INF to +20dBu. Be certain to raise the pink noise level to the level of loudness intended during the performance. Once the Pink level has been adjusted to the desired volume, press the <Next pg> button and the Auto-EQ sequence will begin. The display will

either show the graphic EQ or the RTA. Rotating the <Data> wheel clockwise and counter clockwise will toggle between the two modes. You can also select either mode as the default in the Utility menu. Regardless, the display will appear something like this:

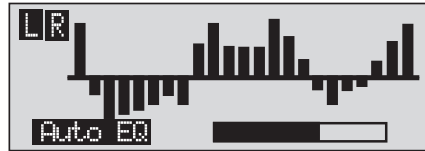

- At this point, the DriveRack® PX will automatically EQ to compensate for the room. Auto-EQ can be aborted at any point in the process by pressing the <PREV PG> button. Upon completion of the Auto-EQ Wizard, you can continue on to the AFS wizard by releasing the <RTA Input> button and pressing the <Next PG> button.

For more information regarding the Auto-EQ section, please refer to the Auto-EQ Optimization Tips information located in the Appendix section.

AFS WIZARD

- The DriveRack® PX also offers its exclusive patented AFS (Advanced Feedback Suppression) module. This unique feature makes unwanted feedback in a PA system a thing of the past. Once you have completed the Auto-EQ™ wizard, the AFS wizard will lead you through the setup of the fixed filters of the AFS module. (The AFS wizard can be initiated at any time by pressing and holding the <AFS> button.) The display will look like this:

```

DriveRack PX
  AFS WIZARD
<NEXT PG> to advance
  
```

- Press the <NEXT PG> button and the display will read:

```

AFS
Please turn down the
mixer gain. Press
NEXT PG when done.
  
```

- Once the gain level of the mixer has been turned down, press the <NEXT PG> button and the display will read:

```

AFS
Select Number of
fixed filters. ▶ 6
F F F F F F L L L L L L
  
```

- You will now use the <DATA> wheel to select the number of fixed filters. This will range from values 0-12. The total number of filters will stay at 12, and the number of live filters will be = Total Num Filters – Num Fixed. Live and Fixed filter types differ in that FIXED mode filters are automatically assigned to a frequency creating feedback, thus remaining at that frequency until cleared by the user. In LIVE mode, live filters automatically detect and remove feedback frequencies in the presence of audio (music or speech). When all of the live filters have been used, they begin to round robin. Essentially this means that the first filter set is replaced where a new feedback is detected and notched out. This mode is useful because feedback frequencies may change as the microphone is moved, and/or as the characteristics of the venue change.

The Fixed/Live filter usage will be indicated at the bottom of each page of the AFS menu. 'F' indicates an available fixed filter, and 'L' indicates an available live filter. A blocked out F or L indicates a filter that is set, or in use. Once the desired number of fixed filters has been selected, press the <NEXT PG> and the display will read:

```

AFS
Select fixed type
▶ Music High
  Ultra Narrow Notch

```

- These types pertain to the Q, sensitivity, and algorithm type. The filter is established by using the formula: $Q = \text{Freq} / \text{Bandwidth}$. This means that a higher Q will produce a filter that is more narrow. Values are: Speech (Bandwidth = 1/5 octave and $Q=7.25$), Music Low (Narrow notch filter, Bandwidth = 1/10 octave and $Q=14.5$), Music Medium (Very Narrow notch filter, Bandwidth = 1/20 octave and $Q=29$), Music High (Ultra Narrow notch filter, Bandwidth = 1/80 octave and $Q=116$). To guarantee that feedback is suppressed at lower frequencies, the AFS may place wider notch filters at these lower frequencies (below 700 Hz). Once the desired fixed type has been selected, press the <NEXT PG> button and the display will read:

```

Slowly Increase the
mixer gain to
desired level.
F F F F F L L L L L L

```

- You are now prompted to raise the output gain of the mixer to the level of the performance. Once the desired level has been set and all of the fixed filters have been assigned, the unit will automatically move you to the page that indicates the fixed filter setup has been completed. If you have reached the performance level setting and all of the fixed filters have not been used, you may want to return to the page that selects the number of fixed filters and re-adjust the number of fixed in order to provide you with additional live filters. Regardless, once you have completed the setup, the display will read:

```
AFS  
Fixed Filter Setup  
Done. In LIVE mode.  
FFFFFFFFLLLLLL
```

- To return to preset mode, simply press the <PRESET> or <NEXT PG> button. For more information regarding feedback elimination, please see the AFS parameters of the Detailed parameters section.







Section 3 - Editing Functions

The DriveRack® PX has been carefully designed and engineered to ensure that all aspects of operation are intuitive and logical. Simply stated, the DriveRack® PX operating system was designed with the user's best interest in mind.

3.1 Basic Navigation Modes

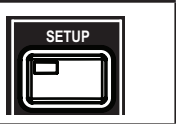
Navigational aspects of the DriveRack® PX are clear, concise and more important: flexible. The DriveRack® PX provides you with essentially three different modes of navigation when performing preset edits. 1. EDIT buttons - This array of 5 edit buttons is your primary mode of directly accessing any signal processing module. 2. NEXT PG & PREV PG page buttons - Successive presses of the NEXT PG or PREV PG page buttons will move the user from one page to the next in a signal processing editor. 3. Data Wheel - The Data Wheel is used to move through the preset menu of the DriveRack® PX. The Data wheel is also used to change the values of the selected parameter by simply rotating the wheel. Pressing the Data wheel will toggle between the available parameters on any selected page of the currently selected editor.

3.2 Button Array Overview

	<p>PREVIOUS PAGE - Moves to the previous page in the currently selected menu.</p>
	<p>NEXT PAGE - Moves to the next page in the currently selected menu.</p>
	<p>SETUP - Press and release to enter the high-pass and bandpass filter editor. Press and hold to enter the first page of the Powered Speaker Setup Wizard.</p>
	<p>SUBHARMONIC - Selects the Subharmonic Synthesizer editor.</p>
	<p>COMP/LIMITER - Press to cycle through the compressor editor and output limiter editors.</p>
	<p>EQ - Press and release to cycle through the graphic EQ and parametric EQ editors. Press and hold to enter the first page of the Auto-EQ Wizard</p>
	<p>PRESET/RECALL - Press and release to return to the preset view, showing preset number, preset bank (user or factory), preset name, and signal path. Press and hold to activate the [RECALL] button function which provides for selection and loading of a new preset.</p>

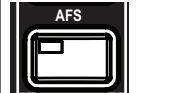
	<p>STORE/UTILITY - Press and release to enter the Store menu, which allows the user to store the current state to a user preset. Press and hold to adjust LCD contrast, Auto-EQ plot selection (RTA or GEQ), and Sales Banner on/off.</p>
	<p>AFS - Press and release to enter the Feedback processing editor. Press and hold to enter the first page of the AFS Wizard.</p>

3.3 Navigating the High-pass and Bandpass Filter (SETUP) Section

To edit the parameters of the high-pass and bandpass filter used in a selected preset, simply use the following procedure. From preset mode, press the SETUP button. Once you have reached the high-pass and bandpass filter module, navigate through the pages of the selected high-pass and bandpass filter module by pressing the "Next Page" or "Prev Page" buttons successively until arriving at the desired Page.

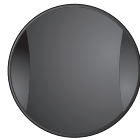
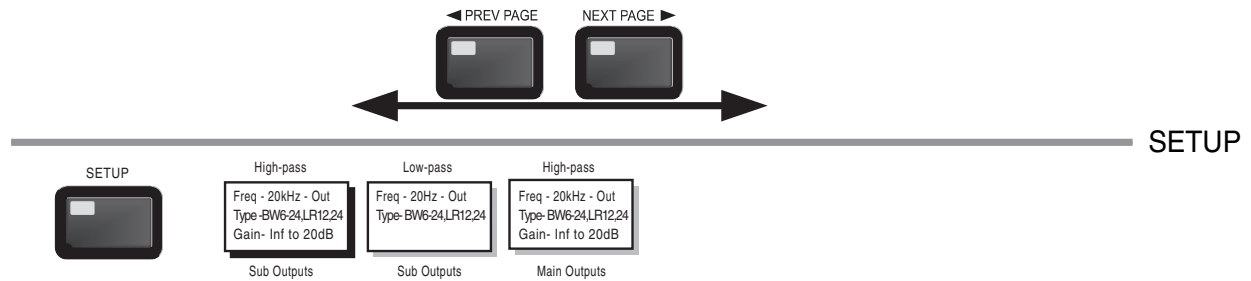

Successive presses of the Data wheel will select effect parameters within the currently selected page.

3.4 Navigating the Subharmonic Section

From preset mode, press the SUBHARMONIC button. Pressing the Data Wheel will select the parameter to be edited.

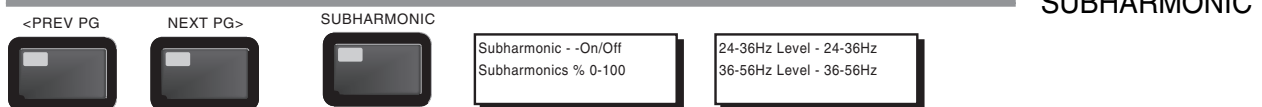

The NEXT and PREV buttons scroll through the pages of selected module.



Successive presses of the Data wheel will select parameters within the currently selected page.

3.5 Navigating the Comp/Limiter Section

From preset mode, press the comp/limiter button to move to either the Compressor or Limiter module(s). Successive presses of COMP/LIMITER button will toggle between the Compressor and Limiter modules. Navigate through the Pages of the Compressor module by pressing the "Next Page" or "Prev Page" buttons successively until you arrive at the desired Page.

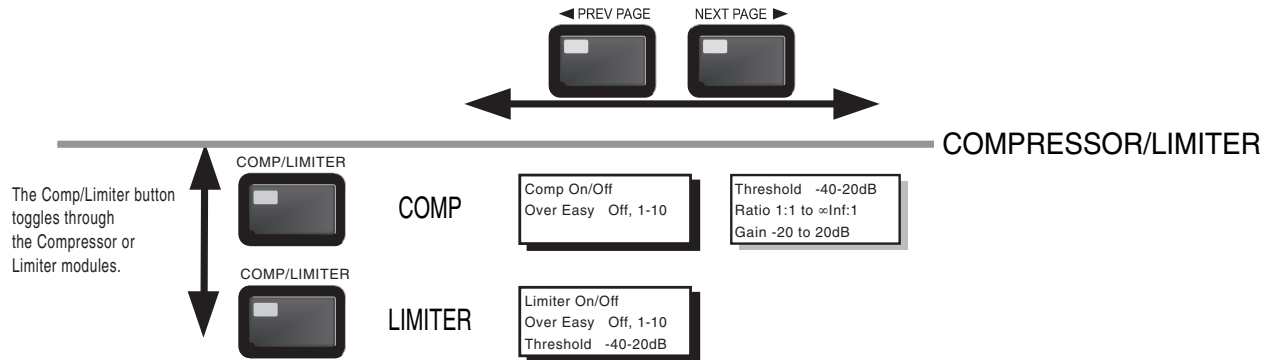

Successive presses of the Data wheel will select effect parameters within the currently selected page.

3.6 Navigating the EQ Section

To edit the parameters of the EQs used in a selected preset, simply use the following procedure. From preset mode, press the EQ button to reach the EQ module to be edited. Successive presses of the EQ button toggle between the GEQ and the PEQ. Navigate through the Pages of the selected EQ section by depressing "Next Page" or "Prev Page" successively until arriving at the desired Page.

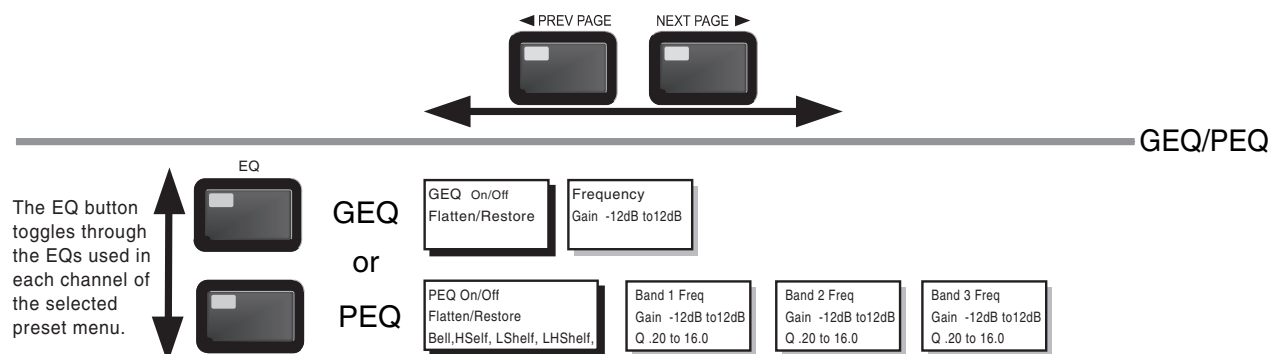

Successive presses of the Data wheel will select parameters within the currently selected page.

3.7 Navigating the AFS Section

From preset mode, press the AFS button. Pressing the Data Wheel will select the parameter to be edited.

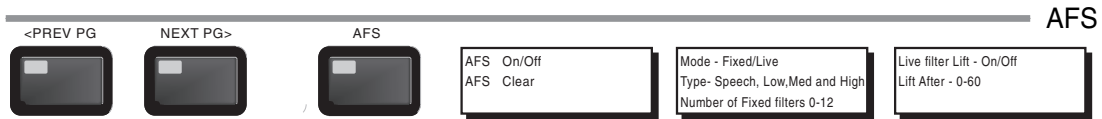

The NEXT and PREV buttons scroll through the pages of selected module.



Successive presses of the Data wheel will select parameters within the currently selected page.

3.8 Navigating the Utility Section

From preset mode, press and hold the UTILITY button. Pressing the Data Wheel will select the parameter to be edited.



Successive presses of the Data wheel will select parameters within the currently selected page.

3.9 Navigating the Wizard Section

From preset mode, press and hold one of the WIZARD buttons (Setup, EQ, or AFS).

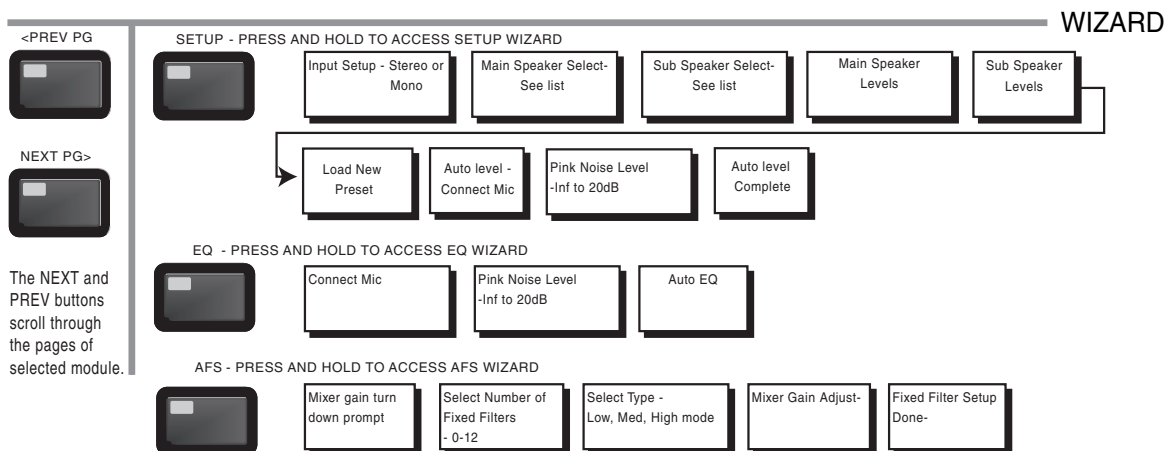

The NEXT and PREV buttons scroll through the pages of selected module.



Successive presses of the Data wheel will select parameters within the currently selected page.

3.10 Navigating the Recall Section

From preset mode, press and hold the RECALL button. Turn the Data wheel to select a preset; press the Data wheel to load the preset.

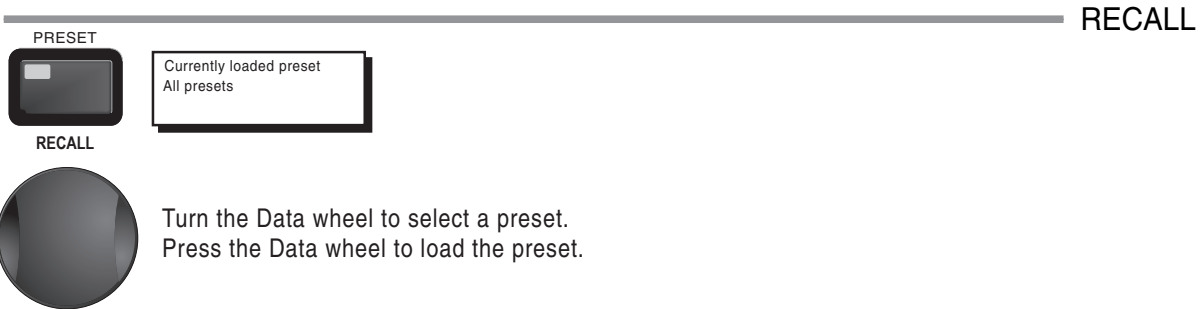

3.11 Navigating the Store Section

From preset mode, press the STORE button. Press the NEXT and PREV buttons to select characters in the preset name. Turn the Data wheel to change the selected character. Press the Data wheel to toggle between uppercase, lowercase, punctuation, and numeric characters. Press the Store button to save the name and advance to preset location screen. Turn the Data wheel to select a preset location; press the Store button to save the preset to that location. Press the PRESET button to escape without storing.

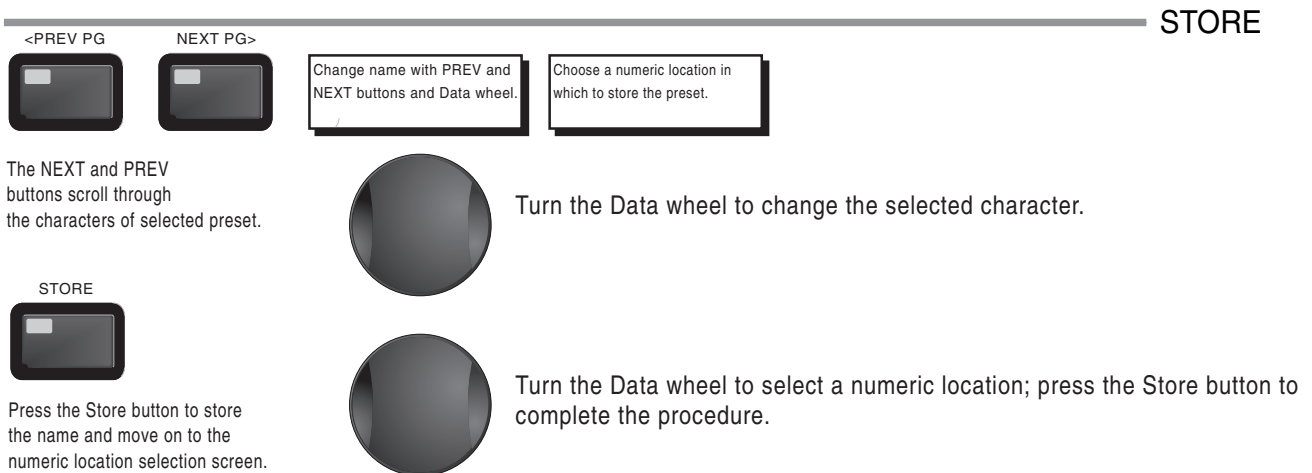

Section 4 - Operating Functions

The Operation section of the DriveRack® PX will be your key to successful navigation of the operation of the DriveRack® PX. The following information provides descriptions about preset functions and operating functions of the DriveRack® PX.

4.1 Preset Definition

The first step in understanding the capabilities of the DriveRack® PX is to understand the elements involved, that when combined, define a complete “preset.” Within an individual preset, there are several levels of editing that make up the complete preset. After turning the unit on, you will be at the “preset” mode level. This level supplies the user with current preset information such as: current signal path, signal processing, and preset name. From this point, the DriveRack® PX gives you the option of entering subsequent levels of operation that are dedicated to preset editing. The Utility menu mode is accessed via the utility menu, and is not part of a single preset.

4.2 Navigating Factory Presets

From the factory, the DriveRack® PX is shipped with 25 factory presets that utilize various constructed routing configurations that have been designed to accommodate common sound reinforcement and installation applications. The factory presets offer explanatory titles to help get you up and running in a timely manner. These presets can also be used as templates or starting points for the user to create custom user presets.

Selecting Presets:

The quickest way to get up and running with the DriveRack® PX is to use any one of the factory presets that are available in the box. When you reach the factory preset, a FACT icon (meaning “factory”) will appear above the factory preset name. From recall mode, use the <Data> wheel to scroll through the various presets. As each factory preset is selected, the title of each factory preset is indicated on the bottom line of the LCD to the left. You will see that each of these titles are directly related to a specific application. Once a preset is selected, press the <Data> wheel to load the preset. The display will appear something like this:

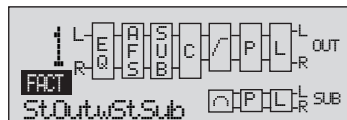

Navigation Modes

The function buttons of the DriveRack® PX allow direct access to all editing and navigating functions of the DriveRack® PX. The functions of the aforementioned buttons are as follows:

- <PREV PG> - Moves to the previous page in the currently selected menu.
- <NEXT PG> - Moves to the next page in the currently selected menu.
- <SETUP> - Press and release to enter the high-pass and bandpass filter editor. Press and hold to enter the first page of the Powered Speaker Setup Wizard.
- <SUBHARMONIC> - Press to enter the dbx 120A Subharmonic Synthesizer editor.
- <COMP/LIMITER> - Press to cycle through compressor editor and output limiter editors.
- <EQ> - Press and release to cycle through the graphic EQ and output parametric EQ. Press and hold to enter the first page of the Auto-EQ Wizard.
- <PRESET/[RECALL]> - Press and release to return to the preset view, showing preset number, preset bank (user or factory), preset name, and signal path. Press and hold to activate the [RECALL] button function which provides for the selection and loading of presets.
- <STORE/[UTILITY]> - Press and release to enter the Store menu, which allows the user to store the current state to a user preset. Press and hold to adjust LCD contrast, Auto-EQ plot selection (RTA or GEQ), and Sales Banner on/off.
- <AFS> - Press and release to enter the AFS editor. Press and hold to enter the first page of the AFS Wizard.

4.3 Editing Factory Presets

Once you have reached the module that you wish to edit, simply use the <PREV PG> and <NEXT PG> buttons to move through the pages within the module. The <DATA> wheel is used to edit parameter values. The following illustration shows an example of the Comp module in edit mode:

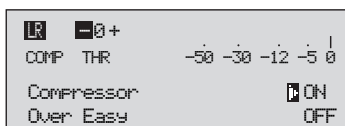

Note that the arrow indicates the currently selected parameter for editing. To select parameters to edit from the current page, simply press the <DATA> wheel until the arrow is pointing to the parameter that you wish to edit.

Once you are satisfied with the changes that have been made to a factory or user preset, the DriveRack® PX allows you to save these changes as a custom USER preset by pressing the <STORE> button, and the display will appear as follows:

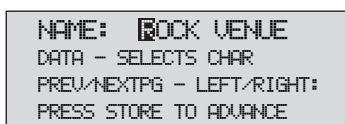

- Rotating the <DATA> wheel will change the characters on the currently selected position.
- Pressing the <DATA> wheel will toggle between upper and lowercase letters, numbers or symbols.
- Use the <PREV PG> and <NEXT PG> button to move character positions.
- Once the desired title has been written, press the <STORE> button again and the display will now appear something like this:

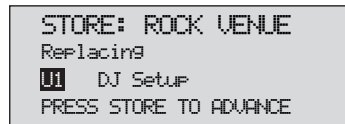

```
STORE: ROCK VENUE
Replacing
U1 DJ Setup
PRESS STORE TO ADVANCE
```

- Rotate the <DATA> wheel to select the user preset number to be replaced and press the <STORE> button again and the existing preset will be replaced with the new preset.

The DriveRack® PX will store 25 user presets in addition to the 25 factory presets.

Note: Factory presets cannot be over-written. When storing changes to a Factory preset, you must replace an existing User preset.

Note that the USER icon indicates a custom user preset, as opposed to the FACT icon.

Section 5 - Detailed Parameters

The DriveRack® PX offers complete editing flexibility, by offering in-depth control over every parameter within each signal processing module. The following section will provide you with descriptions and explanations of all parameters within the DriveRack® PX.

5.1 Stereo Input Graphic EQ

EQ On/Off

Turns the GEQ on and off.

Flatten/Restore

This parameter either flattens the GEQ or restores the GEQ to the last setting before flattening. The DriveRack PX unit allows you to leave the EQ edit window and return without losing the edited EQ settings.

Frequency (F) 31.5Hz to 16.0kHz

This parameter allows you to select any one of the 28 available frequencies.

Gain (G) -12 to +12 dB

This parameter allows you to adjust the level of any one of the 28 bands of the GEQ in 0.5 dB increments.

5.2 AFS (Automatic Feedback Suppression)

Feedback is caused when a microphonic signal such as a guitar pickup or microphone is reproduced by amplification and is repeatedly picked up by the guitar pickup or microphone in phase. AFS uses Precision Frequency Detection and state-of-the-art processing to determine the exact portions of a given frequency of your feedback that need to be removed (instead of taking out large sections of your sound). The AFS module of the DriveRack® PX allows the user to optimize the elimination of feedback. In the past, graphic equalizers were used to eliminate feedback from a system. This was an acceptable method for eliminating feedback, but when this method was precision tested, the result clearly showed that a single 1/3 octave EQ slider was removing approximately half of the signal power. With the AFS, the module removes the feedback automatically and the proprietary, precision AFS filters remove only a fraction of the frequency spectrum. The following diagram shows AFS as opposed to competitive feedback eliminators and conventional graphic EQs. The widest filter shown is a typical 1/3 octave EQ band. The narrower filter indicates the typical bandwidth of competitors' filters. The narrowest filter is the dbx AFS filter. The narrow filter results in highly effective feedback suppression without compromising the sound.

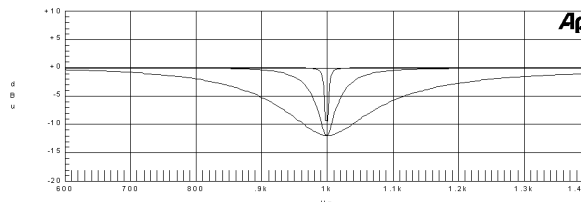

AFS On/Off

Turns the AFS module on and off. If AFS is Off, the filters are bypassed, and the algorithm is halted (the filters are not updated). If AFS is On, the filters are active, and they are updated according to the current selected mode (Fixed or Live).

Clear Live/All

This parameter clears the filters. If Clear Live is selected, then (if invoked) the live filters are reset. If Clear All is selected, then (if invoked) all of the filters are reset. When either Clear Live or Clear All is selected, the third parameter row displays "Start w/ Data Wheel." If Clear (none) is selected, then nothing is displayed on this row. When the user moves to this third row and turns the Data Wheel (when Clear Live or Clear All is selected) then the filter reset is invoked.

Mode - Live or Fixed

When the mode is Fixed, the algorithm updates only the fixed filters. When the mode is Live, the algorithm updates only the live filters. In FIXED mode, the filters are automatically assigned to a frequency creating feedback, thus remaining at that frequency until cleared by the user. Fixed mode is used before the performance without any input signal. In LIVE mode, the live filters automatically detect and remove feedback during the performance. When all of the live filters have been used, they begin to round robin. Essentially this means that the first filter set is replaced where a new feedback is detected and notched out. This mode is useful because feedback frequencies may change as the microphone is moved, and/or as the characteristics of the venue change.

Type - Speech, Low Music, Medium Music and High Music

If Fixed or Live mode is chosen, the text will read "Type." The options will be Speech, Music Low, Music Medium and Music High. These types pertain to the Q, sensitivity, and algorithm type. Values are: Speech (Bandwidth = 1/5 octave and Q=7.25), Music Low (Bandwidth = 1/10 octave and Q=14.5), Music Medium (Bandwidth = 1/20 octave and Q=29), and Music High (Bandwidth = 1/80 octave and Q=116). Note: To guarantee that feedback is suppressed at lower frequencies, the AFS may place wider notch filters at these lower frequencies (below 700 Hz).

Number Fixed - 0-12

This will range from values 0-12. The total number of filters will stay at 12, and the number of live filters will be = Total Num Filters – Num Fixed. If this is changed before the filters are reset, then the filters will be reset one by one as the number changes. For example, if

the number of Fixed filters goes down, then the last fixed filter set will be reset. Likewise, if the number of Fixed filters goes up (and thus the number of live filters goes down), then the last live filter set will be reset. The Fixed/Live filter usage will be indicated at the bottom of each page of the feedback elimination effect. 'F' indicates an available fixed filter, and 'L' indicates an available live filter. A blocked out F or L indicates a filter that is set, or in use.

Live Filter Lift (On/Off)

This parameter turns the Live Filter Lift on and off.

Lift After - 5 sec to 60 min

This parameter allows the user to setup the box so that the Live filters will automatically be removed after a set time (as indicated by the "Lift After" parameter). It ranges from 5 seconds to 60 minutes. This feature is useful if the microphone being used is moved or the characteristics of the venue change over time. As an example, a filter placed minutes ago will not likely be presently preventing feedback. This feature removes unnecessary filters from the spectrum to ensure sonic quality. If the feedback is still there (after the filter is removed), it will catch it and notch it out again.

5.3 Subharmonic Synthesizer

The Subharmonic Synthesizer module has been specifically optimized to enhance Bass audio material for use in a variety of professional applications, including nightclub and dance DJ mixing, theatre and film sound, music recording, live music performance and broadcasting. The Subharmonic Synthesizer module's two separate bands of subharmonic synthesis provide the best combination of smoothness and control, and the independent low frequency boost circuit is designed to get the most out of high-performance low frequency speaker systems.

Sub-Harmonic Synth - On/Off

Turns the Subharmonic Synth module on and off.

Sub-Harmonics Synth - 0 to 100%

This parameter sets the overall level of the Subharmonic Synthesizer.

24-36Hz and 36-56Hz (Subharmonic Synthesis) Level - 0 to 100%

These controls individually let you customize the amount of the respective synthesized frequencies to be added in, tuning the ultimate bass response of your system to taste. For example, if the sound is too woofy or growly, try turning down the 36Hz-56Hz level. If your woofers are bottoming out (making a ticking, popping sound), try turning down the 24Hz-36Hz level. You may find that a setting produces fine results in one room, but produces too much boominess in another. If this occurs, adjust the controls as needed. Experimentation will pay off with smooth, full, deeply extended bass. Remember, you are not selecting a frequency. You are controlling the overall level of each band.

IMPORTANT! The Subharmonic Synthesis process creates very low frequency audio material that your powered speakers may not be designed to reproduce. Attempting to achieve

enhanced bottom end with these systems may not be possible and may result in over-stressing or even damaging your speakers. It is generally not a good idea to use this feature without a subwoofer. In any case, please refer to your powered mains and powered subwoofer speakers' frequency response specifications, and avoid forcing them to reproduce low frequencies that they are not designed to reproduce.

5.4 Compressor/Limiter

The DriveRack® PX also offers legendary dbx OverEasy® Compression with VariKnee™, and proprietary dbx PeakPlus™ Limiter modules. The Compressor is a full bandwidth Stereo Compressor located prior to the high-pass and bandpass filters. The Compressor is the perfect tool for tightening uneven signal sources such as vocals and guitars. The PeakPlus Limiters are located on each stereo output channel and have been strategically placed for powered speaker protection. Note that Compressor/Limiter threshold metering can be observed on page two of the Utility section. The parameters for the Compressor/Limiter are as follows and are user adjustable.

COMPRESSOR

Compressor On/Off

Turns the Compressor module on and off.

OverEasy (O) Off to 10

There are ten levels of OverEasy® that can be used for the limiters. The point when the compressor starts to compress is the "knee." When the compressor starts to reduce the level of a signal abruptly as it passes over the threshold, this is called "hard knee" compression. OverEasy® (soft knee as it is sometimes called) is when the volume of the sound is compressed gradually. OverEasy® compression starts to compress before the level of the signal reaches the threshold and reaches full compression after the level has gone above the threshold. OverEasy® compression, by its very nature, sounds much smoother and more natural and will be used for most applications. When it is gentle (natural sounding or light) compression that you are looking for, the compressor offers VariKnee™. VariKnee™ gives you ten levels of OverEasy® compression to choose from (1 being almost hard knee and 10 being the most OverEasy®). This lets you choose the exact knee that is needed for the dynamic effect you are looking for.

Threshold (T) -40 to +20dBu

Threshold is the signal level at which the unit starts to compress the signal. If the level is set to -10 dBu, than any signal larger than -10 dBu is compressed while any signal that has a level that is lower than -10dBu is left at the same signal level. Light compression is where only the loudest parts of the signal go over the threshold. Very heavy compression can be achieved by setting the threshold low enough that almost the entire signal content is over the threshold. For most signals the most natural compression is achieved when most of the signal content remains just below the threshold and only the peaks cross the threshold.

Ratio (R) 1.0 to Inf:1

Ratio is the amount the unit reduces the signal level of the sound that is above the threshold. A 2:1 ratio means that if the incoming signal is 2dB over the threshold the unit will compress the signal, and outputs a signal that only goes 1dB over the threshold. For light compression choose a lower ratio, while a heavy compression requires a higher ratio. A setting of Inf:1 makes the compressor act more like a limiter.

Gain (G) -20 to +20 dB

This parameter is used to compensate for the gain lost during compression. By using heavy compression on a signal and then boosting the signal with the output gain, the user can create a signal that sounds much louder than it actually is.

LIMITER**Limiter On/Off**

Turns the PeakPlus™ Limiter module on and off.

OverEasy (O) Off to 10

There are ten levels of OverEasy® that can be used for the limiters. The point when the limiter starts to limit is the “knee.” When the limiter starts to reduce the level of a signal abruptly as it passes over the threshold this is called “hard knee” limiting. OverEasy® (soft knee as it is sometimes called) is when the volume of the sound is limited gradually. OverEasy® limiting starts to limit before the level of the signal reaches the threshold and reaches full limiting after the level has gone above the threshold. This OverEasy® limiting, by its very nature sounds much smoother and more natural. When it is gentle (natural sounding or light) limiting that you are looking for, the limiter offers VariKnee™. VariKnee™ gives you ten levels of OverEasy® limiting to choose from (1 being almost hard knee and 10 being the most OverEasy®). This lets you choose the exact knee that is needed for the type of limiting you are looking for.

Threshold (T) -40 to +20dBu

Threshold is the signal level at which the unit starts to limit the signal. If the level is set to -10 dBu, any signal larger than -10 dBu is limited while any signal that has a level that is lower than -10dBu is left at the same signal level. Light limiting is where only the loudest parts of the signal go over the threshold. Very heavy limiting can be achieved by setting the threshold low enough that almost the entire signal content is over the threshold. For most signals, the most natural limiting is achieved when most of the signal content remains just below the threshold and only the peaks cross the threshold.

5.5 Filter (SETUP)

The Filters are used to divide the input signal into two frequency bands. This allows the user to drive the speaker in its optimum frequency range and send each output separately for more efficient use of amplifier power. Appendix A.5 illustrates each of the available Filters. The signal present at the Main (OUT) outputs can be adjusted using a High-Pass filter. The signal present at the Subwoofer (SUB) outputs can be adjusted using Band Pass filters consisting of Low-Pass and High-Pass filters. When editing Filter parameters the frequency band is indicated by the highlighted OUT or SUB in the top left corner of the screen. The High-Pass or Low-Pass filter being edited is indicated by the highlighted edge in the graphics area.

For each High Pass filter there are three parameters:

Frequency

Adjusts the frequency of the High Pass filter from OUT (below 20Hz) to 20KHz.

Type

Selects the filter type. Selections are BW 6,12,18,24 for Butterworth type filter with slope of 6, 12, 18 or 24 dB/Octave and LR12, 24 for Linkwitz-Riley type with slope of 12 or 24 dB/Octave.

Gain

Sets the gain of the selected output band. (-INFdB to +20dB)

For each Low-Pass filter there are two parameters:

Frequency

Adjusts the frequency of the Low Pass filter from 20Hz to OUT (greater than 20kHz).

Type

Selects the filter type. Selections are BW 6,12,18,24 for Butterworth type filter with slope of 6, 12, 18 or 24 dB/Octave and LR12, 24 for Linkwitz-Riley type with slope of 12 or 24 dB/Octave.

5.6 Output Parametric EQ (3-band)

EQ On/Off

Turns the PEQ on and off.

Flatten/Restore

This parameter either flattens or restores all bands to their original settings

Type

This parameter selects the PEQ type. Types include:

1. Bell - All three parametrics are bell-shaped
2. HShelf - One shelf is High, while the other two are bell
3. LShelf - One shelf is Low, while the other two are bell
4. LHSshelf - One shelf is High, one is Low, and the other one is bell.

F1 - F3 (Frequency)

Selects the frequency of the selected band of the parametric EQ. (20Hz to 20kHz)

G (Level)

Sets the gain of the selected parametric EQ band. (-12dB to 12dB)

Q (Bandwidth)

Sets the Q (a measurement of Bandwidth) of the selected Parametric EQ. (0.20 to 16)

Section 6 - Application Guide

This Application guide section is provided to offer suggested installation applications of the DriveRack® PX that will allow you to optimize peak performance of the units. Note that the 25 included application presets represent the flexibility of the DriveRack® PX. These applications can be used verbatim, or as sample reference guide templates for designing numerous audio applications.

6.1 Mains-Only Setup (No Subs)

Hardware

1. Make sure that the mixer and powered speakers are turned off prior to powering up the DriveRack® PX.
2. Connect the outputs from the mixer to the inputs of the DriveRack® PX.
3. Connect the main outputs of the DriveRack® PX to the main powered speakers.

Software

1. Use the Wizard to set up a specific preset. Press and hold the <SETUP> button to begin. See page 8 for more information.

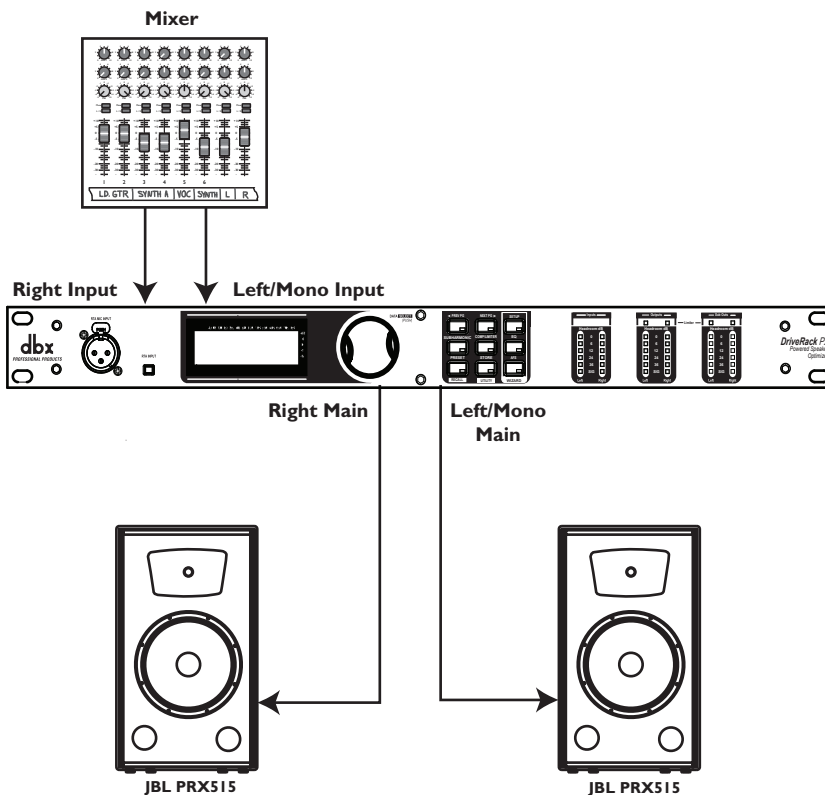

6.2 Two Mains/One Subwoofer Setup

Hardware

1. Make sure that the mixer and powered speakers are turned off prior to powering up the DriveRack® PX.
2. Connect the outputs from the mixer to the inputs of the DriveRack® PX.
3. Connect the main outputs of the DriveRack® PX to the main powered speakers.
4. Connect the Left/Mono sub output of the DriveRack® PX to the sub powered speaker.

Software

1. Use the Wizard to set up a specific preset. Press and hold the <SETUP> button to begin. See page 8 for more information.

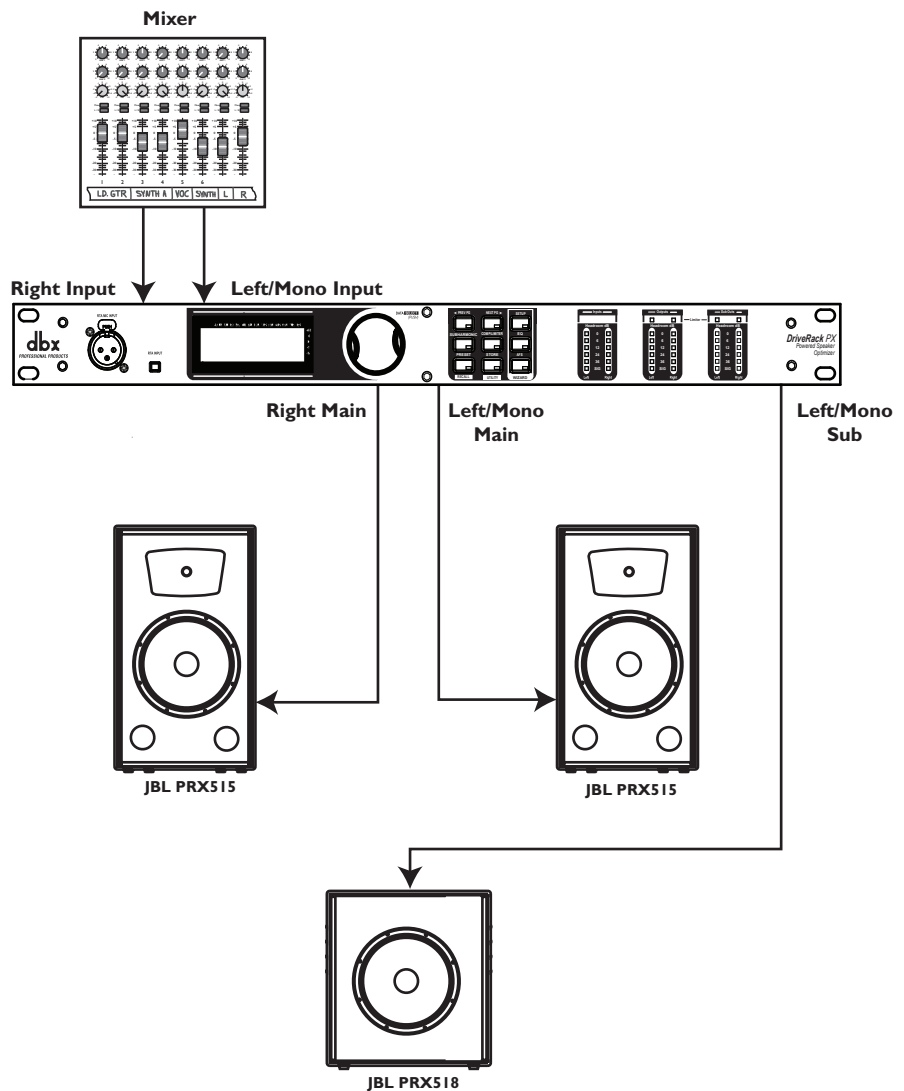

6.3 Two Mains/Two Subwoofers Setup

Hardware

1. Make sure that the mixer and powered speakers are turned off prior to powering up the DriveRack® PX.
2. Connect the outputs from the mixer to the inputs of the DriveRack® PX.
3. Connect the main outputs of the DriveRack® PX to the main powered speakers.
4. Connect the sub outputs of the DriveRack® PX to the sub powered speakers.

Software

1. Use the Wizard to set up a specific preset. Press and hold the <SETUP> button to begin. See page 8 for more information.

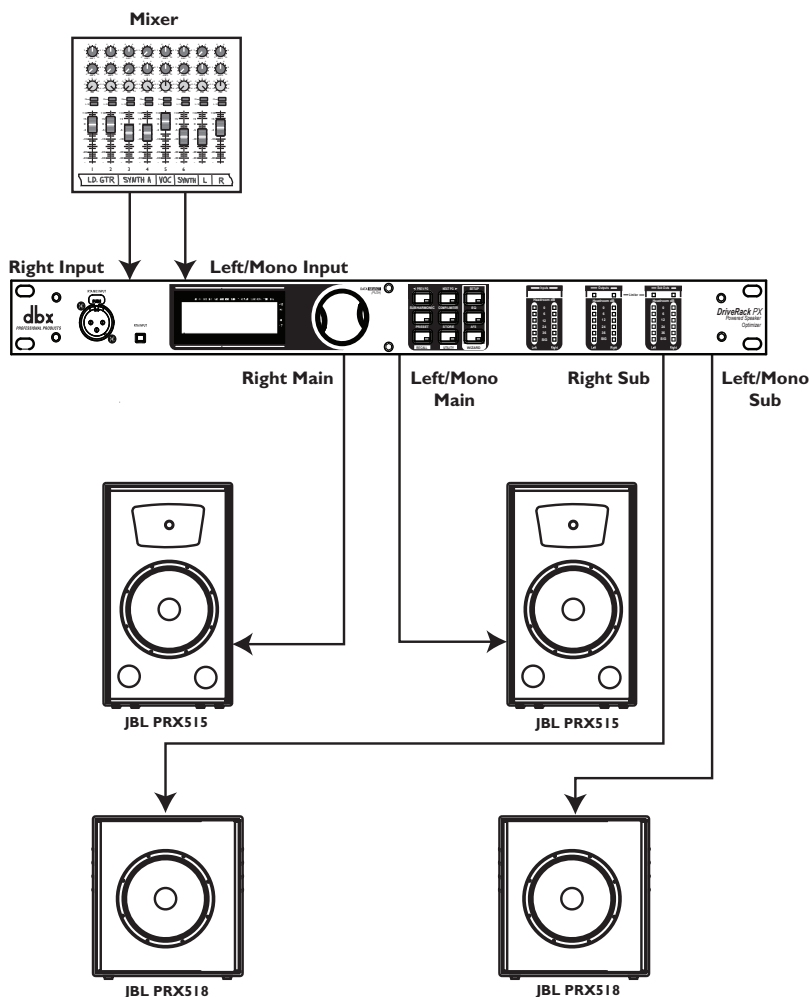

6.4 Sub with Satellites Setup

Hardware

1. Make sure that the mixer and powered speakers are turned off prior to powering up the DriveRack® PX.
2. Connect the outputs from the mixer to the inputs of the DriveRack® PX.
3. Connect the main outputs of the DriveRack® PX to the sub powered speaker.
4. Connect the outputs of the sub speaker to the satellite speakers.

Software

1. Use the Wizard to set up a specific preset. Press and hold the <SETUP> button to begin. See page 8 for more information.

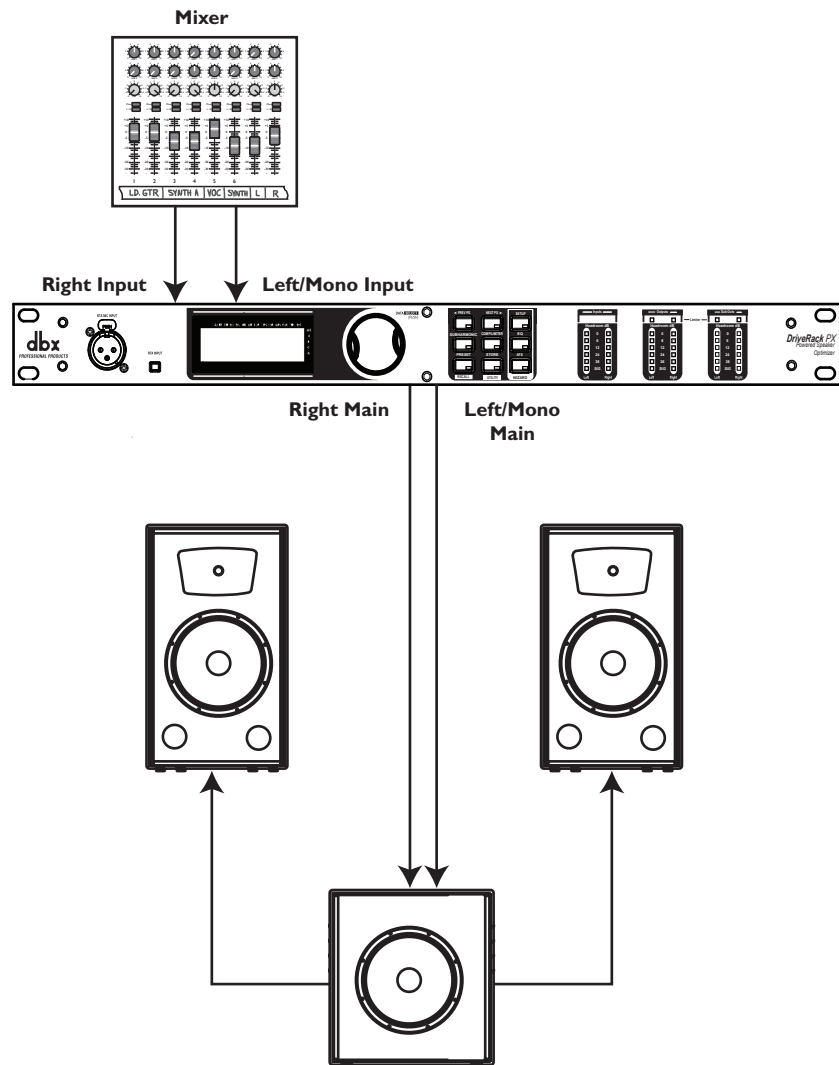

Section A - Appendix

A.1 Factory Reset

In the event that a reset is required, the DriveRack® PX offers you the option of performing a “Soft” or “Hard” reset. The Soft Reset resets all operating parameters except user presets. The Hard Reset Procedure will reset all preset information back to the factory defaults.

All Power-Up Functions require a button(s) to be pressed and held as the unit power is turned on.

DriveRack PX Power-Up Button Functions

Factory (“Hard”) Reset.

Press and hold the <STORE> button at power-up until the following message appears:

“! HARD RESET?”
“Yes <PREV PAGE>”
“No <PRESET>”

- Pressing the <PREV PAGE> button will start a Factory Reset (All User Presets will become copies of the Factory Presets, all Utility settings will be defaulted, and all Security settings will be defaulted).
- Pressing the <Preset> button will abort the Factory Reset sequence and the unit will reset normally.

System (“SOFT”) Reset

• Press and hold the <COMP/LIMITER> button at power-up until the following message appears:

“! SOFT RESET?”
“Yes <PREV PAGE>”
“No <PRESET>”

- Pressing the <PREV PAGE> button will start a System Reset (All Utility settings will be defaulted.)
- Pressing the <Preset> button will abort the System Reset sequence and the unit will reset normally.

A.2 Power Up Quick Key Options

The DriveRack® PX offers several “Quick Key” options for initial power up and are as follow:

Change Initial Preset Number

• To change the initial power preset number, Press and hold the <PRESET> button at power-up until the following message appears:

“Use Wheel to Change Restart Preset Number”

- Turning the <Data> wheel will select the preset you wish to load at initial reset.
- Press the <PRESET> button again when the selection is complete. Normal resetting will continue.

System Lock Out

- Press and hold <AFS> at power-up until one of the following messages appears (depending on the current state of system lockout):

System Unlocked All user input will be accepted <AFS> to exit

or

System Locked! No user input will be accepted <AFS> to exit

or

Filter Unlocked. Filter clear will be accepted <AFS> to exit

- Use the <DATA WHEEL> to select the desired state and then press the <AFS> button to continue booting in the selected state.
- The “System Unlocked” state allows normal operation.
- The “System Locked” state is the complete lockout state. No user button input of any kind will be acted upon.
- The “Filter Unlocked” state is the same as the “System Locked” state except that the <PRESET> and <AFS> buttons are accepted. Pressing <AFS> once will go to the AFS edit page with the “Clear” parameter set to “LIVE” and the cursor on the third parameter “Clear w/ <AFS>”. Pressing and holding the <AFS> button will enable a filter clear. After the clear, the DriveRack PX will return to the preset screen.
- Locked operations will cause a “LOCKED” icon to appear in the upper right corner of the screen for a few seconds.

A.3 Specifications

ANALOG INPUTS:

Number of Inputs:	2 (Stereo) Line inputs 1 RTA Mic input
Connectors:	2 Female XLR line inputs 1 XLR RTA Mic input
Type:	Electronically balanced, RF filtered
Impedance:	>40k Ω
Max Input Line level:	+20dBu
Input CMRR:	>45dB
RTA Mic Phantom Voltage:	+15VDC
RTA Mic EIN:	<-110dBu, 22Hz-22kHz, 150 Ω

ANALOG OUTPUTS:

Number of Outputs:	2 (Stereo) Line outputs 2 Sub outputs (mono or stereo)
Connectors:	2 Male XLR XLR line outputs 2 Male XLR Sub outputs
Type:	Electronically balanced, RF filtered
Impedance:	120 Ω
Max Output Level:	+20dBu

A/D PERFORMANCE:

Type:	dbx Type IV™ conversion system
Dynamic Range:	110dB A-weighted 107dB unweighted
Type IV dynamic range:	123dB with transient material, A-weighted, 22kHz BW 121dB with transient material, unweighted, 22kHz BW 115dB typical with program material, A-weighted, 22kHz BW
Sample Rate:	48kHz

D/A PERFORMANCE:

Dynamic Range:	112dB A-weighted 110dB unweighted
----------------	--------------------------------------

SYSTEM PERFORMANCE:

Dynamic Range:	110dB A-unweighted, >107dB unweighted, 0.002% typical at +4dBu, 1kHz, 0dB input gain
----------------	--

THD+N:

Frequency Response:	20Hz – 20kHz, +/- 0.5dB
Interchannel Crosstalk:	<-110dB, 120dB typical
Crosstalk input to output:	<-100dB

A.4 Auto-EQ Optimization Tips

By using the setup wizard, output gains and output limiter settings are set to match your system. The Auto-EQ can be used to adjust your system to compensate for room effects, and to adjust the response of the entire system to your liking. After allowing Auto-EQ to “pink the room,” your system will sound tighter. The low end will have more definition, the mids will be more intelligible, and the highs can be tamed. Here are two things to look for to get the best performance from the Auto-EQ.

Look out for “Modes”

Some speaker and RTA microphone positions will result in certain frequencies canceling out. The resulting “modes” cannot be corrected with equalization. The Auto-EQ does not detect modes in the frequency response, so it may try to boost a band to compensate for a mode without positive affect. You may be able to see if a lifted band is a mode by manually adjusting a lifted EQ band - if no change in the EQ is perceived, you probably are seeing a mode in your frequency response. To reduce the effect of this mode, try different microphone positions and adjust the location of your speakers, then repink the room for a more effective Graphic EQ adjustment.

Adjust Output Gains

If your system setup or the response you have chosen results in the Auto-EQ lifting or cutting a number of consecutive bands of the Graphic EQ, you can adjust the level of either the main (OUT) gain, or the subwoofer (SUB) gain, depending on which frequencies the Auto-EQ is applying excessive lifting or cutting, then re-pink your room. This time, the adjustment of the Graphic EQ bands will be less “heavy handed” and the system will sound better having fewer phase problems and a lower noise floor than a more aggressively adjusted Graphic EQ. With the rest of your system properly adjusted, the Auto-EQ can compensate for room resonance and adjust to suit personal taste without large excursions in the Graphic EQ bands.

A.5 Crossover Diagrams

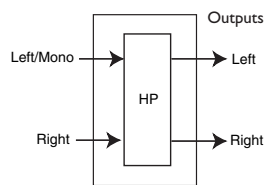

Powered mains only, or sub with satellite system

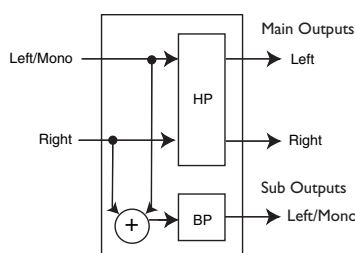

Powered mains, Mono sub

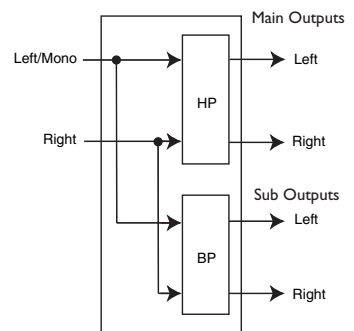

Powered mains, stereo subs

HP - High Pass Filter BP - Band Pass Filter

A.6 Block Diagram

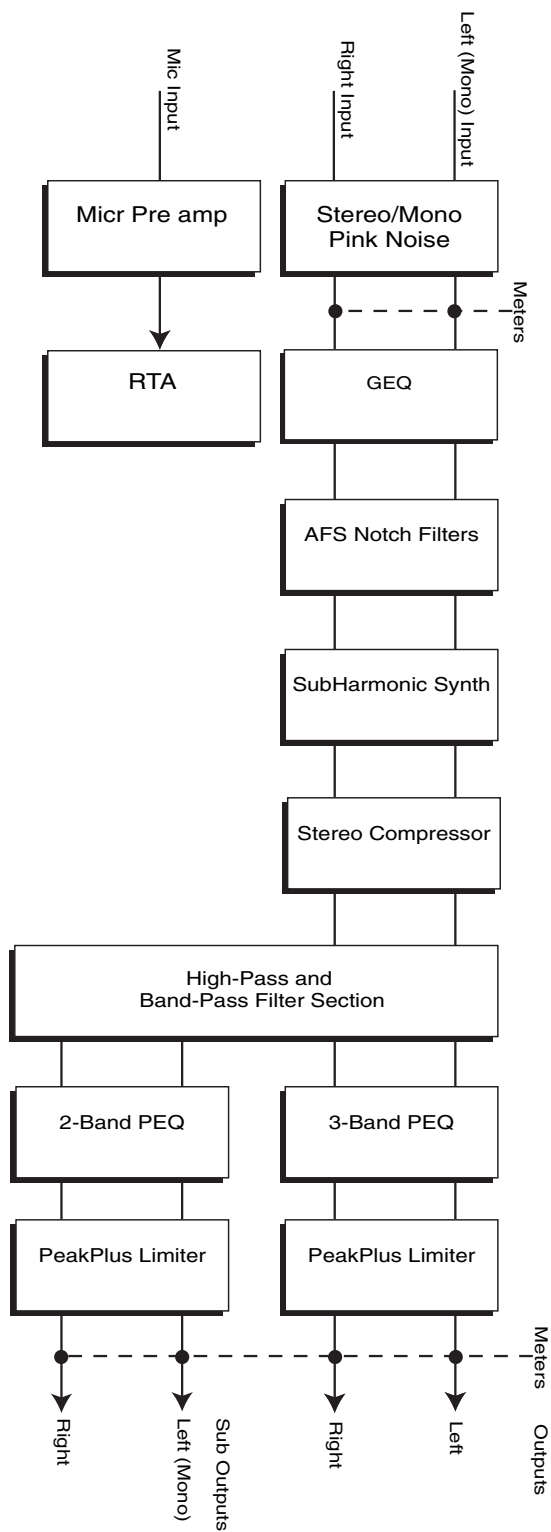

A.7 Preset List / Supported Speakers

PRESET LIST

StereoMains	Stereo powered full-range speakers.
StMainsMSub	Stereo powered full-range speakers with a mono powered subwoofer.
StMainsSSub	Stereo powered full-range speakers with stereo powered subwoofers.
Sub wSats	Sub with Satellite System
PRX515	2 JBL PRX515 full-range speakers
PRX515M518	2 JBL PRX515 powered full-range speakers with 1 JBL PRX518 powered subwoofer.
PRX515S518	2 JBL PRX515 powered full-range speakers with 2 JBL PRX518 powered subwoofers.
EON15G2	2 JBL EON15G2 full-range speakers
EON15G2MSub	2 JBL EON15G2 powered full-range speakers with 1 JBL EONSUB-G2 powered subwoofer.
EON15G2SSub	2 JBL EON15G2 powered full-range speakers with 2 JBL EONSUB-G2 powered subwoofers.
EON10G2	2 JBL EON10G2 full-range speakers
EON10G2MSub	2 JBL EON10G2 powered full-range speakers with 1 JBL EONSUB-G2 powered subwoofer.
EON10G2SSub	2 JBL EON10G2 powered full-range speakers with 2 JBL EONSUB-G2 powered subwoofers.
PRX515M118	2 JBL PRX515 powered full-range speakers with 1 JBL JRX118 powered subwoofer.
PRX515S118	2 JBL PRX515 powered full-range speakers with 2 JBL JRX118 powered subwoofers.
EON10G2M518	2 JBL EON10G2 powered full-range speakers with 1 JBL PRX518 powered subwoofer.
EON10G2S518	2 JBL EON10G2 powered full-range speakers with 2 JBL PRX518 powered subwoofers.
EON10G2M118	2 JBL EON10G2 powered full-range speakers with 1 JBL JRX118 powered subwoofer.
EON10G2S118	2 JBL EON10G2 powered full-range speakers with 2 JBL JRX118 powered subwoofers.
EON15G2M518	2 JBL EON15G2 powered full-range speakers with 1 JBL PRX518 powered subwoofer.
EON15G2S518	2 JBL EON15G2 powered full-range speakers with 2 JBL PRX518 powered subwoofers.
EON15G2M118	2 JBL EON15G2 powered full-range speakers with 1 JBL JRX118 powered subwoofer.
EON15G2S118	2 JBL EON15G2 powered full-range speakers with 2 JBL JRX118 powered subwoofers.
EON15G2 DJ	2 JBL EON15G2 powered full-range speakers with 2 JBL EONSUB-G2 powered subwoofers. Full Range Overlaps sub.
EON10G2 DJ	2 JBL EON10G2 powered full-range speakers with 2 JBL EONSUB-G2 powered subwoofers. Full Range Overlaps sub.

SUPPORTED SPEAKERS

Main Speakers

JBL EON 10G2
 JBL EON 15G2
 JBL PRX515
 dB Technologies Opera Live 202
 dB Technologies Opera Live 205
 dB Technologies Opera Live 402
 dB Technologies Opera Live 405
 Mackie SRM350
 Mackie SRM450
 Peavey PR15P
 QSC HPR 122i
 QSC HPR 153i
 RCF ART 310-A
 RCF ART 312-A
 RCF ART 315-A
 RCF ART 325-A
 Sampson dB500A
 Yamaha MSR400
 Yorkville NX55P

Subwoofers

JBL JRX118SP
 JBL EON Sub G2
 JBL PRX518S
 dB Technologies Opera SUB12
 Mackie SWA1501
 Yorkville NX720S

Sub/Satellite Systems

HK Audio Lucas Impact
 HK Audio Lucas Smart

A.8 System Setup and Gain Structure

The DriveRack PX offers a wide range of tools for sound system design and setup. These tools can make your system more efficient and better sounding, but to get the best possible sound it is important to use these tools properly. In the DriveRack PX we have included a Wizard setup tool to help in system setup. If you use the Wizard to set up your DriveRack PX it will automatically set the limiters for some powered speaker selections. If your powered speakers are not available in the Wizard, you should choose the Custom setting. The following section explains how to maximize system gain and how to use the limiters to protect your powered speakers from clipping.

In traditional system design, the output of your mixer would be routed to a system EQ, a compressor, and a crossover with output level control. From the crossover, there may be additional filters that are employed to improve the response of your speakers. There may also be limiters set up to keep your powered speakers from going into clipping and protect your speakers from the hazards of a clipped signal. Your powered speakers play a vital role in system setup, because they are last item in the chain and offer the greatest amount of gain (that is their job after all). If your powered speakers are incorrectly setup you will not be using your system to its fullest potential.

One thing that is critical to system setup is maximizing gain structure. Gain structure refers to aligning the gain of each device so that they all clip at the same point; and the noise floor of the entire system is at its absolute minimum. Quite often PA systems are setup with the amplifier input controls turned all the way up in the incorrect assumption that this is the only way to get the maximum output level. Amplifiers are fixed gain devices, turning down the amplifier input levels does not change the potential output of the amplifier; it only requires more input voltage to get full output power. Many amplifiers will clip with an input level greater than +6 dBu when the input controls are turned all the way up. Most mixing mixers can deliver over +18 dBu of output level before clipping. This means that with your amps tuned all the way up you are sacrificing 12 dB of headroom, resulting in poorer noise performance and the potential of system clipping. By adjusting the amplifier controls properly, you can maximize your system performance.

A way to set up your system for maximum gain structure is to use the clip indicators and level meters of the mixer, DriveRack PX, and the powered speakers. To do this, hookup the output of the mixer to the input of the DriveRack PX and the outputs of the DriveRack PX into the inputs of your powered speakers. Set up the DriveRack PX for your particular powered speakers. Make sure that the output limiters are turned off on the DriveRack PX. Run a continuous signal (pink noise or sine wave – many test CDs are available that have these types of signals) through your mixer. Turn up the output of the mixer until it begins clipping. If there is no clip indicator on the mixer then use the output meters; most reputable mixer manufacturers use red LEDs at the top of the meters to show the onset of clipping. Once the mixer is clipping, back the output gain down slightly until the clip indicator on the mixer turns off. Turn up the level control on the powered speaker until the clip indicator begins to turn on. Turn the level control down slightly, so the clip indicator no longer is on. If the top red LED lights on the input meters on the DriveRack PX, then you must reduce the level of the mixer feeding the DriveRack PX. If the top red LED lights on the output meters on the DriveRack PX, then you must reduce the level

of that output (refer to section 5.5 -- Also note that if you turn the outputs down on the DriveRack PX, you should turn up the level on the powered speaker until the clip LED lights again). You have just maximized the gain through your system. These setting should give you maximum gain without clipping, another way of say this is that when the output of your mixer is clipping you will also be at the clip point of your powered speakers.

Once you have found the clip point of your powered speakers, you can mark this position and turn the powered speakers back up to the point where they are clipping. You can now use the output limiters in the DriveRack PX to protect the powered speaker from clipping no matter what you do at the mixer. With the powered speakers clipping, now go to the Limiter page of the DriveRack PX and turn on the limiter for each output. Make sure that the threshold is all the way up to +20dB. Now slowly reduce the threshold until the clip indicator of the powered speaker turns off. You have successfully set the output limiter up and the powered speaker will not be able to go into clipping no matter what the input is. You should now proceed to the next output and go through the same process. If you are using a sine wave to create clipping in your powered speaker you should make sure that the sine wave is within the frequency range of the output band that you are working with. Once all the limiters are set up you can now turn the powered speakers back down to the gain maximized position. The Wizard will automatically set your limiters based on your choice of powered speaker. Because of component variances within the powered speaker circuitry, you may need to adjust the limiter settings by a few dB after running the Wizard to ensure that they are set correctly.



PROFESSIONAL PRODUCTS

8760 South Sandy Parkway • Sandy, Utah 84070

Phone: (801) 568-7660 • Fax (801) 568-7662

Int'l Fax: (801) 568-7583

E-mail us at: customer@dbxpro.com

or visit us on the web at: www.dbxpro.com

H A Harman International Company

Free Manuals Download Website

<http://myh66.com>

<http://usermanuals.us>

<http://www.somanuals.com>

<http://www.4manuals.cc>

<http://www.manual-lib.com>

<http://www.404manual.com>

<http://www.luxmanual.com>

<http://aubethermostatmanual.com>

Golf course search by state

<http://golfingnear.com>

Email search by domain

<http://emailbydomain.com>

Auto manuals search

<http://auto.somanuals.com>

TV manuals search

<http://tv.somanuals.com>