

# NanoTrace Moisture Analyzer

## DF-745

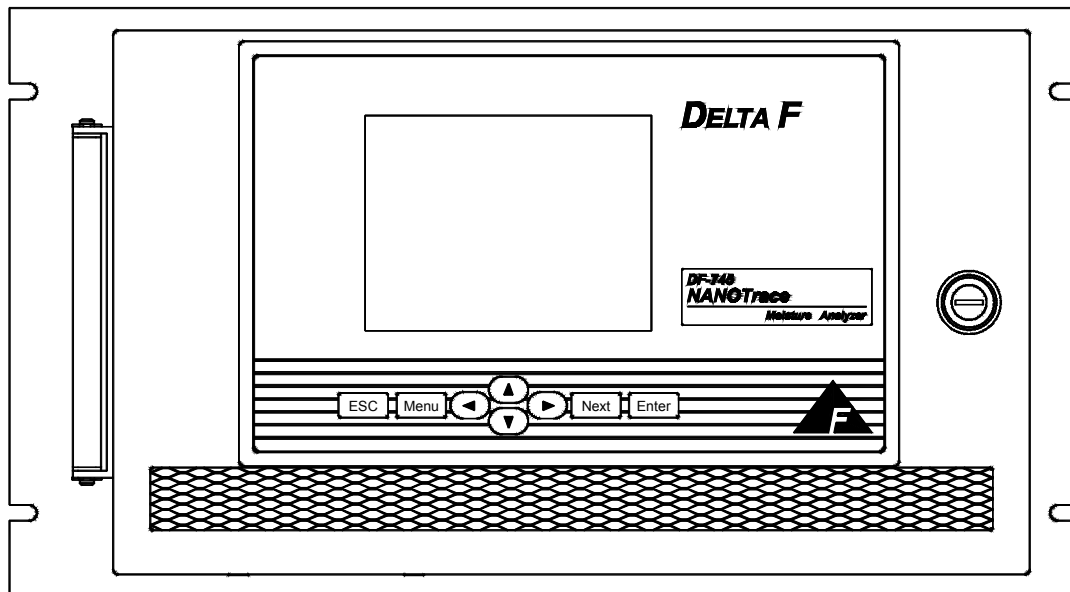

## Instruction Manual

Firmware Version 3.1.5



**DELTA F CORPORATION**  
4 Constitution Way, Woburn, MA 01801-1087  
Telephone: (781) 935-4600 FAX: (781) 938-0531

P/N 99000041  
082510

## The Delta F Difference

Your NanoTrace Moisture Analyzer has been designed, manufactured and is supported under the tightest of controls, thus helping to insure the highest possible standards of quality.

Every analyzer that Delta F manufactures is tested and operated on a variety of gas concentrations to insure that it functions properly when you receive it.

The certificate of calibration assures your analyzer has been calibrated on gases that are traceable to NIST standards. With proper maintenance, your analyzer should remain calibrated for years.

For a fast and successful startup, please read this manual carefully. There are important cautions and a number of helpful hints to help you to optimize the operation of your analyzer.

If you have questions, please do not hesitate to call the Delta F Service Line at (781) 935-5808, use our Service FAX Line at (781) 932-0053 or e-mail us at [Service@Delta-F.com](mailto:Service@Delta-F.com).

Copyright 2004 - 2010 by Delta F Corporation

No part of this publication may be reproduced, stored in a retrieval system or transmitted in any form, or by any means including electronic, mechanical, photocopying, recording or otherwise without prior written permission of Delta F Corporation.

NanoTrace Moisture Analyzer™ is a trademark of Delta F Corporation. VCR® is a registered trademark of the Cajon Company.

# Read Me First...

## Unpacking Procedure

Follow the procedure below to unpack your NanoTrace Moisture Analyzer

1. Examine the condition of the packaging and its contents. If any damage is apparent, immediately notify the carrier and Delta F. Do not proceed with the installation.
2. Check the contents against the packing slip to make sure the shipment is complete. Unattached equipment may be shipped with the analyzer in supplemental packaging. Shortages should be reported to Delta F immediately.
3. All NanoTrace Moisture Analyzers are shipped with the following:

Item	Delta F Part Number
Power cord with 115 VAC connector NOTE: No power cord is supplied with 220 VAC units	P/N 59017237
USB Memory Stick, Flash Drive (SONY USM512J)	P/N 49600512
VCR Filter Gasket	P/N 60300268
Aspirator	P/N 14241410
Instruction Manual	P/N 99000041

4. Open the analyzer door, remove any shipping materials and verify that nothing has come loose during transit.
5. The analyzer is set at the factory to operate on 120 VAC or 240 VAC. Examine the voltage indicator on the rear panel to verify that the voltage is set as ordered.
6. Save the original container in the event you may need to ship the analyzer to another location or back to the factory (see Shipping in the Service section).

## Installation and Maintenance

The NanoTrace Moisture Analyzer provides years of accurate and dependable service if it is set up, operated and maintained properly. It is essential to make a careful and complete installation as outlined in the *Installation and Start Up* section of this manual. It is assumed that NanoTrace Moisture Analyzer users are familiar with the techniques and precautions associated with Ultra-High Purity (UHP) gas, its plumbing, and devices such as UHP regulators and gas purifiers, and that the analyzer is used as designed and intended.

Unlike much UHP analytical equipment, NanoTrace Moisture Analyzer does not require constant maintenance. However the maintenance intervals for zero and span calibrations, must be determined and followed carefully.

### **Thank You**

Thank you for selecting the NanoTrace Moisture Analyzer. Delta F designs, manufactures, exhaustively tests, and supports every analyzer under the tightest quality controls. You should expect every Delta F analyzer to arrive in perfect working order and, with good maintenance, provide years of trouble-free service. Please call the Service Phone Line at (781) 935-5808 if you need assistance or if you have suggestions, or use our Service Fax Line at (781) 932-0053 or e-mail us at [Service@Delta-F.com](mailto:Service@Delta-F.com).

# 1 Table of Contents

<b>1</b>	<b>Table of Contents .....</b>	<b>1</b>
1.1	Table of Figures.....	3
<b>2</b>	<b>Cautions.....</b>	<b>7</b>
2.1	Symbols and Explanations.....	7
2.2	Important Warnings .....	7
<b>3</b>	<b>Specifications .....</b>	<b>9</b>
3.1	Moisture.....	9
3.2	General.....	9
<b>4</b>	<b>Installation, Start Up and Shut Down .....</b>	<b>13</b>
4.1	Analyzer Installation .....	14
4.1.1	Vacuum Source .....	14
4.1.2	Pneumatic Pressure Line Connection - Optional .....	15
4.1.3	Sample Gas Connections .....	15
4.1.4	Electrical Connections.....	17
4.1.5	Hydrogen Service Safety System .....	17
4.2	Analyzer Start Up.....	19
4.2.1	Gas Delivery System.....	19
4.2.2	Gas Pressure and Flow Settings .....	20
4.2.3	Download System Data.....	21
4.3	Analyzer Shut Down .....	21
<b>5</b>	<b>Options .....</b>	<b>25</b>
5.1	Key Lock.....	25
5.2	Operating Voltage .....	25
5.3	Serial Communications.....	25
5.4	Analog Voltage Output.....	25
5.5	Hydrogen Service Safety System .....	25
5.6	Vacuum Pump.....	25
5.6.1	Installation of the Vacuum Pump.....	26
5.6.2	Moisture Sample Gas Outlet Connection to Vacuum Pump.....	28
5.6.3	Electrical Connections.....	28
<b>6</b>	<b>Connecting to External Devices .....</b>	<b>31</b>
6.1	Serial Communication Port – J5 .....	31
6.2	Analog Signal Outputs – J4 .....	32
6.3	4-20 mA Outputs – J4.....	32
6.4	Relay Ports – J8, J9.....	33
<b>7</b>	<b>User Interface .....</b>	<b>35</b>
7.1	Data Display Screen .....	35
7.2	Keypad.....	35
7.3	Menu Structure.....	36
7.4	Main Menu.....	36
7.4.1	Isolate Analyzer – Optional .....	37
7.4.2	Restore Sample Gas Flow – Optional .....	38

7.4.3	Calibrate Menu.....	38
7.4.4	Data History Routine .....	42
7.4.5	Data Downloader Routine.....	44
7.4.6	View Logs Menu .....	46
7.4.7	Analyzer Setup .....	49
7.4.8	Analog Output Setup .....	55
7.4.9	Graph Setup .....	56
7.4.10	Diagnostics Menu .....	56
7.4.11	Adjust Contrast.....	62
7.4.12	Power Up Default – Optional .....	63
7.4.13	Date/Time.....	64
7.4.14	Communications.....	65
7.4.15	Download System Data .....	65
7.4.16	System Info.....	67
<b>8</b>	<b>Sample Gas Preparation and Delivery .....</b>	<b>69</b>
8.1	Introduction.....	69
8.2	Sample Flow Rate and Pressure .....	69
8.3	Flow Rate Effects on Sensor Performance.....	69
8.4	Sample Gas Scale Factor .....	69
8.4.1	Background Gas Effects on Indicated Flow Rate .....	69
8.5	Flammable Sample Gas .....	70
<b>9</b>	<b>Service.....</b>	<b>71</b>
9.1	Return Material Authorization number .....	71
9.2	Maintenance.....	71
9.2.1	Storage Conditions .....	71
9.2.2	Moisture Cell Maintenance.....	71
9.2.3	Vacuum Pump Maintenance.....	71
9.3	Replaceable Parts List.....	73
9.4	Troubleshooting the DF-745 NanoTrace Analyzer .....	75
<b>10</b>	<b>Theory of Operation .....</b>	<b>77</b>
10.1	The Moisture Measurement.....	77
10.1.1	Moisture and the IR Spectrum.....	77
10.1.2	Absorption Spectroscopy.....	78
<b>11</b>	<b>Safety.....</b>	<b>79</b>
11.1	General Warnings.....	79
<b>12</b>	<b>Warranty .....</b>	<b>81</b>
<b>13</b>	<b>Index .....</b>	<b>83</b>
<b>14</b>	<b>Appendix A – User Menu Screens.....</b>	<b>85</b>
<b>15</b>	<b>Appendix B – Hydrogen Service Safety System.....</b>	<b>89</b>
15.1	Instrument .....	89
15.2	Vacuum Pump .....	89
15.3	Installation.....	89
15.4	Operation.....	90

# 1.1 Table of Figures

Figure 1: Overall View.....	11
Figure 2: Major Internal Components.....	13
Figure 3: Aspirator Installation .....	14
Figure 4: Rear Gas Connections .....	16
Figure 5: Rear Gas Connections and Controls with Optional Gas Panel.....	16
Figure 6: AC Power Connections .....	17
Figure 7: AC Power Connections with Optional Gas Panel.....	18
Figure 8: Data Display Screen .....	19
Figure 9: Block Diagram of Gas Flow Path and Aspirator .....	22
Figure 10: Block Diagram of Gas Flow Path with Optional Valves and Aspirator.....	23
Figure 11: Vacuum Pump Assembly.....	26
Figure 12: Vacuum Pump Mount Dimensions .....	27
Figure 13: Vacuum Pump Dimensions .....	27
Figure 14: Vacuum Pump Power Connections and Controls .....	28
Figure 15: Block Diagram of Gas Flow Path and Optional Vacuum Pump.....	29
Figure 16: Block Diagram of Gas Flow Path with Optional Valves and Vacuum Pump .....	29
Figure 17: Rear Panel Electrical Connectors.....	31
Figure 18: Data Display Screen .....	35
Figure 19: Keypad.....	36
Figure 20: Main Menu .....	36
Figure 21: Main Menu (without valve option) .....	37
Figure 22: Isolate Analyzer .....	37
Figure 23: Isolate Warning.....	38
Figure 24: Restore Sample Gas Flow .....	38
Figure 25: Calibrate Menu .....	39
Figure 26: Check/Adjust Zero Menu.....	39
Figure 27: Check/Adjust Zero Screen .....	40
Figure 28: User Zero Offset.....	40
Figure 29: Manual Zero Screen .....	41
Figure 30: Data History Menu .....	42
Figure 31: Data History Screen.....	43
Figure 32: Install Media .....	43
Figure 33: Example of Data Download.....	43
Figure 34: Data Downloader Menu.....	44
Figure 35: Data Downloader Screen .....	44
Figure 36: View Location Screen.....	45
Figure 37: Keyboard Display.....	45
Figure 38: Delete Selection.....	46
Figure 39: View Zero Log Menu .....	46
Figure 40: Zero Log Screen .....	47
Figure 41: View System Error Code Log Menu .....	47
Figure 42: System Error Code Screen .....	48
Figure 43: Pump Capacity Test Log Menu.....	48
Figure 44: Pump Capacity Test Log.....	49
Figure 45: Sample GSF Menu .....	49
Figure 46: Sample GSF Setup Screen .....	50
Figure 47: GSF Pressure Setting.....	50
Figure 48: Fan Failure Alarm.....	50

Figure 49: Alarm Setup Menu .....	51
Figure 50: Alarm Setup Screen .....	52
Figure 51: Temperature Alarm Setup .....	53
Figure 52: Pressure Alarm Setup .....	53
Figure 53: System Alarm Setup .....	54
Figure 54: Analog Output Setup Menu .....	55
Figure 55: Analog Output Setup Screen .....	55
Figure 56: Graph Setup Menu .....	56
Figure 57: Graph Setup Screen .....	56
Figure 58: Active Zero On/Off Menu .....	57
Figure 59: Test Relays Menu .....	58
Figure 60: Test Alarm Relays Screen .....	58
Figure 61: Test Analog Outputs Menu .....	59
Figure 62: Test Analog Voltage Output Screen .....	59
Figure 63: Signal Monitor Menu .....	60
Figure 64: Signal Monitor Screen .....	60
Figure 65: Pump Capacity Test Menu .....	61
Figure 66: Pump Capacity Test Screen .....	61
Figure 67: Pump Pressure Failure .....	61
Figure 68: Pump Capacity Test Log .....	62
Figure 69: Adjust Contrast Menu .....	62
Figure 70: Adjust Display Contrast Screen .....	62
Figure 71: Power Up Default Menu .....	63
Figure 72: Power Up Default Screen .....	63
Figure 73: Date/Time Menu .....	64
Figure 74: Date/Time Setup Screen .....	64
Figure 75: Communications Menu .....	65
Figure 76: Communications Setup Screen .....	65
Figure 77: Download System Data Menu .....	66
Figure 78: Insert Media .....	66
Figure 79: Media Warning .....	66
Figure 80: Download Time Line .....	67
Figure 81: System Info Menu .....	67
Figure 82: System Info Screen .....	68
Figure 83: Software Upgrade Screen .....	68
Figure 84: Schematic of Moisture Cell .....	77
Figure 85: Hydrogen Service Safety System .....	93
Figure 86: Pump Purge Option .....	94



# Table of Tables

Table 1: Recommended Sample Outlet Vacuum Pressure .....	21
Table 2: Pin-out of Serial Comm Connector J5 .....	32
Table 3: Serial Communications Connections .....	32
Table 4: Pin-Out of Moisture Signal Output Connector J4 .....	32
Table 5: Pin-Out of Relay Connectors J8 and J9 .....	33
Table 6: Alarm Codes .....	51
Table 7: Sample Outlet Pressure.....	69
Table 8: Replaceable Parts List.....	73



# 2 Cautions

There are a number of warnings and cautions that must be observed to avoid damage to the analyzer as well to insure the safety of its users. The analyzer must be operated in a manner specified in this manual. Delta F cannot be responsible for direct or consequential damages that result from installing or operating the analyzer in a manner not described in this manual. Importantly, the analyzer has been designed for use with inert, non-toxic, non-combustible sample gases only. Delta F cannot be responsible for direct or consequential damages that result from using the analyzer with these gases.

## 2.1 Symbols and Explanations

Following is a list of the various symbols used throughout this manual and their definitions.

### CAUTION



*This symbol alerts the user to the presence of physically hazardous conditions that may be dangerous to individuals or equipment.*

### NOTE



*This symbol alerts the user to the presence of important operations and/or maintenance information.*

## 2.2 Important Warnings

### CAUTION



*Potentially hazardous AC voltages are present within this instrument. Leave all servicing to qualified personnel. Disconnect the AC power source when installing or removing: external connections, the sensor, or the electronics.*

### CAUTION



*Do not setup or operate this analyzer without a complete understanding of the instructions in this manual. Do not connect this Analyzer to a power source until all signal and plumbing connections are made.*

### CAUTION



*This analyzer must be operated in a manner consistent with its intended use and as specified in this manual.*

### EMI DISCLAIMER



*This Analyzer generates and uses small amounts of radio frequency energy. There is no guarantee that interference to radio or television signals will not occur in a particular installation. If interference is experienced, turn-off the analyzer. If the interference disappears, try one or more of the following methods to correct the problem:*

- Reorient the receiving antenna.
- Move the instrument with respect to the receiver.
- Place the analyzer and receiver on different AC circuits.

# 3 Specifications

## 3.1 Moisture

**Lowest Detection Level (LDL):** 2 ppb @ Constant Conditions

**Resolution:** Analytical (Smallest Detectable Change): .5 ppb

Display: 100 ppt

**Accuracy:** Greater of  $\pm 3\%$  of reading or  $\pm 1$  ppb @ Constant Conditions

**Speed of Response:** Typically 10 minutes to reach 90 percent of an upward step change

**Upset Recovery Time:** Typically less than 5 minutes from a high ppb upset to within 10 ppb of the previously stable reading.

**Range:** 0-20 ppm

**Background Gas Compatibility:** All inert and passive gases including N<sub>2</sub>, H<sub>2</sub>, He, Ar and O<sub>2</sub>

## 3.2 General

**Warranty:** One year from ship date on the entire instrument. See *Warranty* section on page 81.

**Power Requirements:** 100 to 120 VAC, 50/60 Hz, standard, 5 Amps  
200 to 240 VAC, 50/60 Hz (optional), 2.5 Amps

**Display:** 7.4 inch VGA Color (640X480)

**Ambient Operating Temperature:** 10° C to 40° C (50° F to 105° F)

**Output Signals:**

Analog Output: User Scalable: 0-2 ppb to 0-20 ppm Moisture

0-1, 0-2, 0-5, or 0-10 VDC (minimum load resistance 1K)

Isolated 4-20 mA DC, 1K ohm loop resistance max (28V Compliance voltage provided)

**Digital Communications:** Two-way RS-232 or RS-485 set at the time of order

**Operating Inlet Pressure:** 5 to 30 psig (0.3 to 2 bar)

**Flow Rate:** 0.5 – 4.0 slpm N<sub>2</sub>

**Sample Temperature:** 10° C to 80° C (50° F to 176° F)

**EMI Sensitivity:** Tested to standards EN61000-3-3 and EN61326-1

**Audible/Visual Alarm Status Indicators:** Four Moisture levels, Temperature, Moisture cell Diagnostic, Zero Verification or Calibration in Process, Moisture Analyzer off-line, Analog output freeze during calibration.

**Alarm Relays:** Four non-latching, independently assignable to moisture alarms or to moisture calibration-in-process indicator. SPDT contacts rated at 1 Amp @ 30 VDC. Fail safe action upon loss of power to alarm condition. Not designed to switch AC power.

**Storage Temperature:** Not to exceed 50° C (122° F)

**Construction:** NEMA 1, 19 inch rack mount

**Dimensions:** 19 inch (48.3cm) wide x 10.5 inch (26.7 cm) high x 22.5 inch (57.2 cm) deep

**Weight:** 70 pounds (31.8 kg)

**Gas Path Construction Materials:**

300 series stainless steel electro-polished

1/4-inch VCR-type compatible sample inlet fitting

1/8-inch compression sample outlet fitting

1/4-inch compression vacuum fitting

Kel-f valve seats

PTFE Vacuum tubing

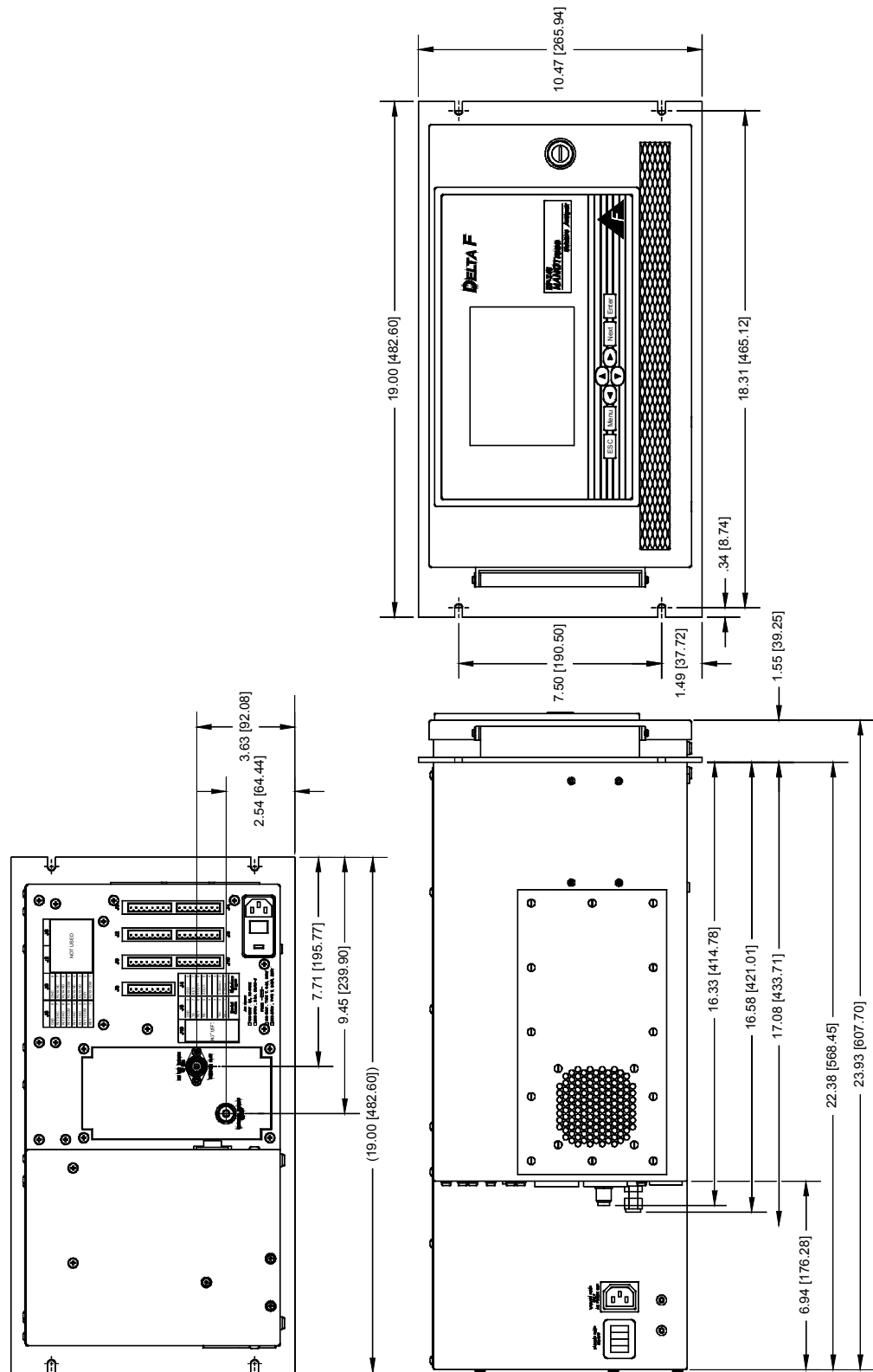

Figure 1: Overall View





# 4 Installation, Start Up and Shut Down

Installation of the analyzer requires the following steps be followed:

- Connecting the N<sub>2</sub>/Air supply to the aspirator
- Connecting an exhaust tube to the aspirator outlet, if needed
- Connecting the pneumatic pressure service to the pneumatic inlet fitting
- Connecting the sample gas line to the analyzer inlet fitting
- Making the power connection to the analyzer

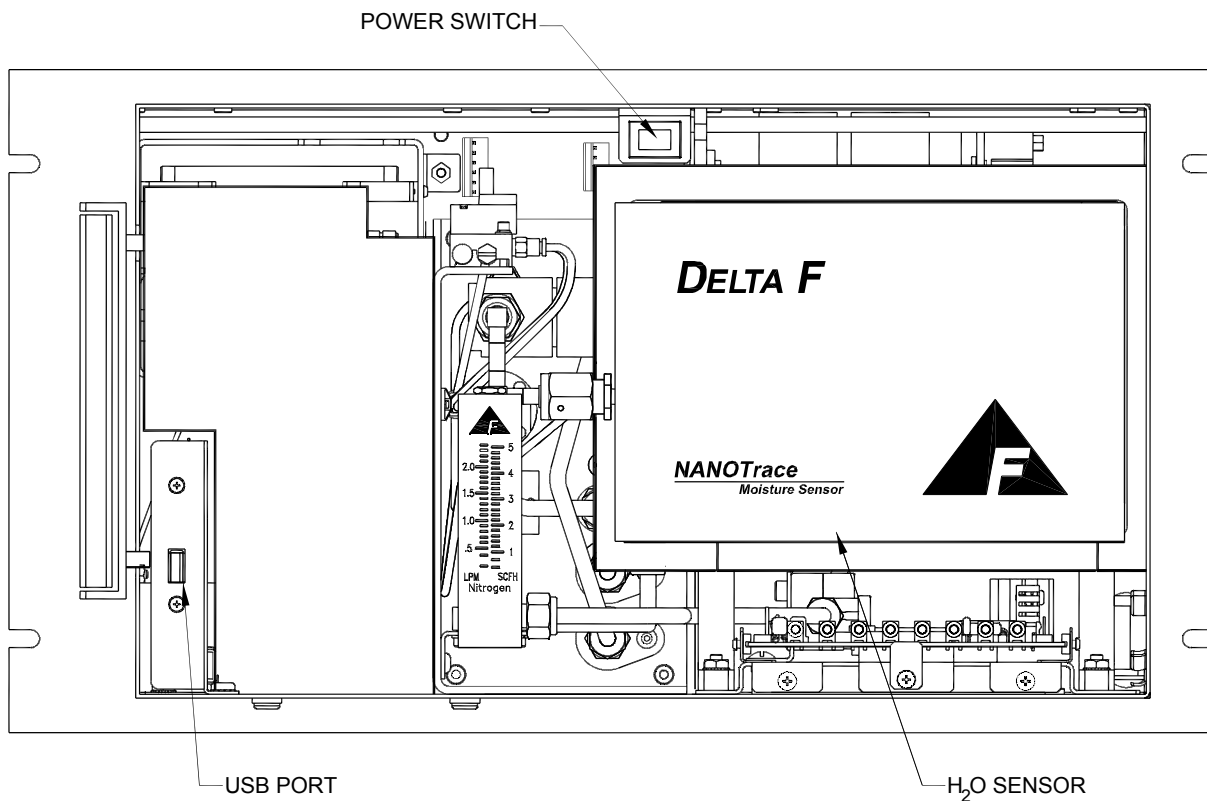

Figure 2: Major Internal Components

## 4.1 Analyzer Installation

### 4.1.1 Vacuum Source

#### 4.1.1.1 Aspirator

The standard vacuum source provided with the DF-745 analyzer is a factory installed aspirator as shown in Figure 3. Aspirator installation with the optional gas panel is identical.

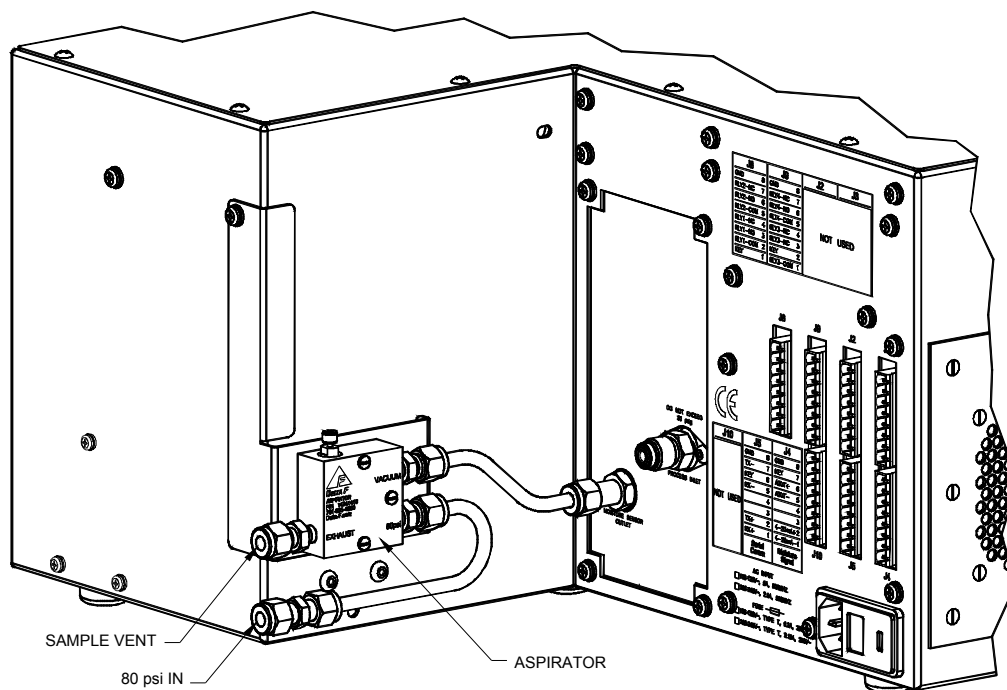

Figure 3: Aspirator Installation

A regulated source of dry compressed gas (either N<sub>2</sub> or air) is required at 80psi and a flow rate of approximately 15 slpm. Connection is made to the aspirator by way of a ¼ inch compression fitting labeled “80 psi IN”. It is very important to note that the diameter of the gas supply line must be a minimum of ¼ inch to provide sufficient flow. If operation in Helium background is anticipated, a shut off valve should be installed at the inlet to the aspirator.

For ease of installation, the aspirator source can also supply the pneumatic gas inlet by way of a 1/8 inch adapter.

The gas at the sample vent port is comprised of the analyzer sample gas and the compressed gas, and any noise can be mitigated by simply installing a ¼ inch tube of approximately 3 ft in length. Backpressure should be minimized at this port (max 2.0 psi) and if the exhaust must be vented for safety reasons it must be done to a header of greater diameter.

The aspirator needle valve should be opened (CCW) completely.



Be sure to use a backup wrench when making all connections to the aspirator.

#### 4.1.1.2 Vacuum Pump

An optional vacuum pump can be purchased for those cases where there is insufficient gas pressure or flow to operate the aspirator, or when the analyzer is installed in a portable cart and connection to a continuous gas supply is inconvenient. See page 25 for information on the installation of the optional vacuum pump.

### 4.1.2 Pneumatic Pressure Line Connection - Optional

The pneumatic gas connection (required for the optional gas panel) is a 1/8 inch compression fitting as shown in Figure 5 and requires 70 – 125 psig air or N<sub>2</sub> pressure. For ease of installation, the pneumatic feed line can be connected directly to the 1/4 inch aspirator source by way of a 1/8 inch adapter.

### 4.1.3 Sample Gas Connections

#### 4.1.3.1 Sample Gas Inlet Connection

Sample gas is connected to the analyzer via a 1/4 inch male swivel VCR fitting labeled Process Inlet at the rear of the instrument as shown in Figure 4. Sample pressure of 30 – 150 psig is required and is regulated internally.

Pre-purge the line by connecting to the analyzer (with a new VCR *filter* gasket) only finger tight and flowing gas for 15 minutes. Then tighten the inlet fitting.

NOTE: A VCR *filter* gasket (supplied) should always be used to protect the gas delivery system from any particulate matter that may have collected in the line.

When power is applied to the analyzer, the internal gas control valves will automatically go to a state as determined by the user. See the section on Power Up Defaults on page 63 for additional information.

NOTE: When received from the factory, if equipped with internal gas valves, the moisture cell will be isolated with pressure in the system. See the sections on Moisture Gas Valves Control on pages 38 for instructions on starting the gas flow through either sensor.

See Figure 9 for an overview of the gas flow through the analyzer.

See the section on Gas Pressure and Flow Settings on page 20 for important information on plumbing and powering up the analyzer.

#### 4.1.3.2 Sample Gas Outlet Connection

The sample gas outlet connection is a 1/4 inch compression fitting labeled Moisture Sensor Outlet as shown in Figure 4. A 1/4 inch stainless tube is connected from the analyzer sample outlet to the Aspirator assembly. See Figure 3. **Open the needle control valve (CCW) on the top of the aspirator assembly completely.** NOTE: If the Hydrogen Service Safety System is included, the sample outlet line must be made of steel. See page 89 for additional information.

See page 25 for information on the installation of the optional vacuum pump.

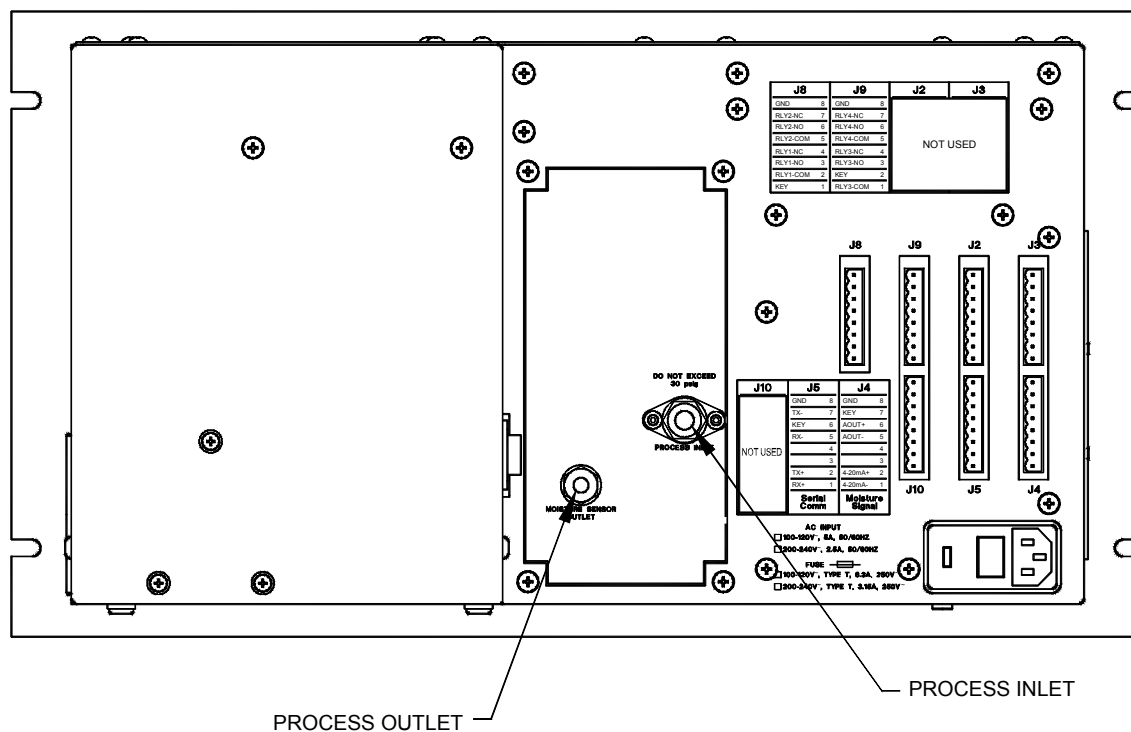

Figure 4: Rear Gas Connections

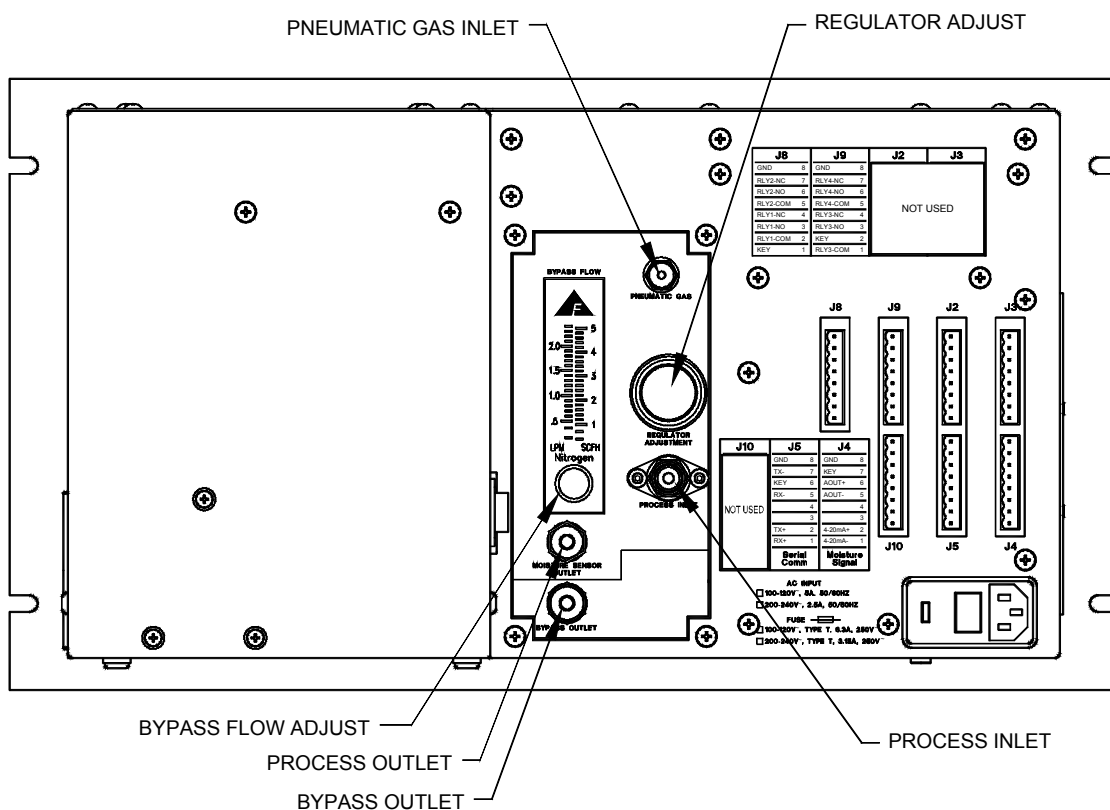

Figure 5: Rear Gas Connections and Controls with Optional Gas Panel

## 4.1.4 Electrical Connections

Open the door and locate the power switch in the center of the upper rail. Be sure it is in the OFF position. Plug the line cord (supplied with 110VAC units only) into the receptacle at the back of the analyzer. Verify the operating voltage is proper according to the label on the rear and connect the line cord to the power source. See Figure 6 and Figure 7.

## 4.1.5 Hydrogen Service Safety System

This optional system is designed to safeguard the DF-745 from explosion hazards when operating on hydrogen sample gas under normal pressure and flow conditions as detailed in the Operating Instruction Manual. The instrument chassis and the remote pump, if equipped, are both protected by maintaining a safe condition within their respective enclosures. If installed, this option impacts the electrical wiring, gas plumbing and operation of the analyzer. See page 89 for additional installation and operation information.

NOTE, if equipped with the Hydrogen Safety Service System, when shipped from the factory the analyzer will be configured through the GSF screen to measure hydrogen. As a result, the Hydrogen Safety Service System will be enabled out of the box.

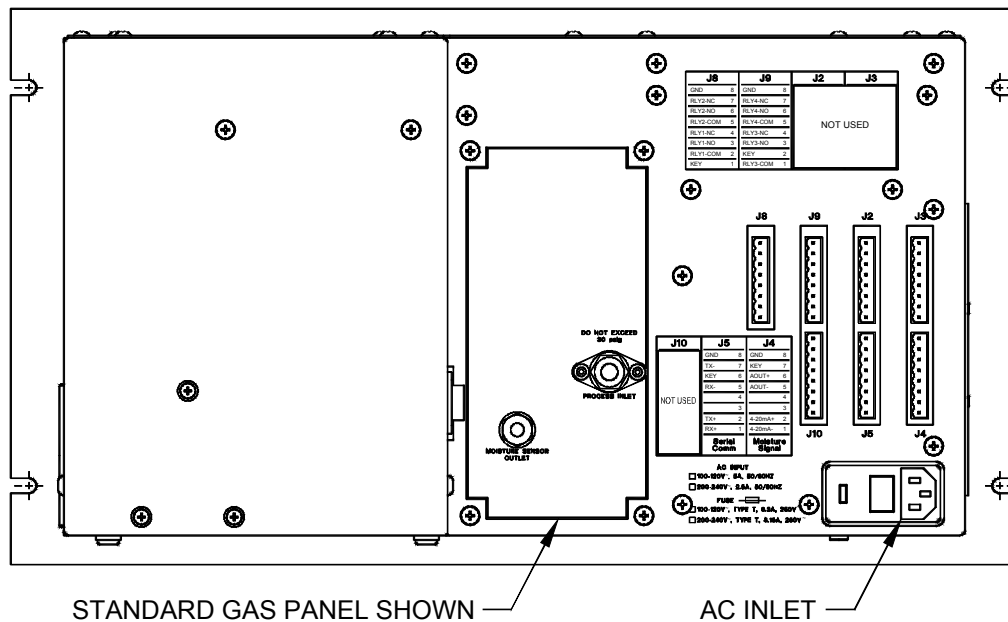

Figure 6: AC Power Connections

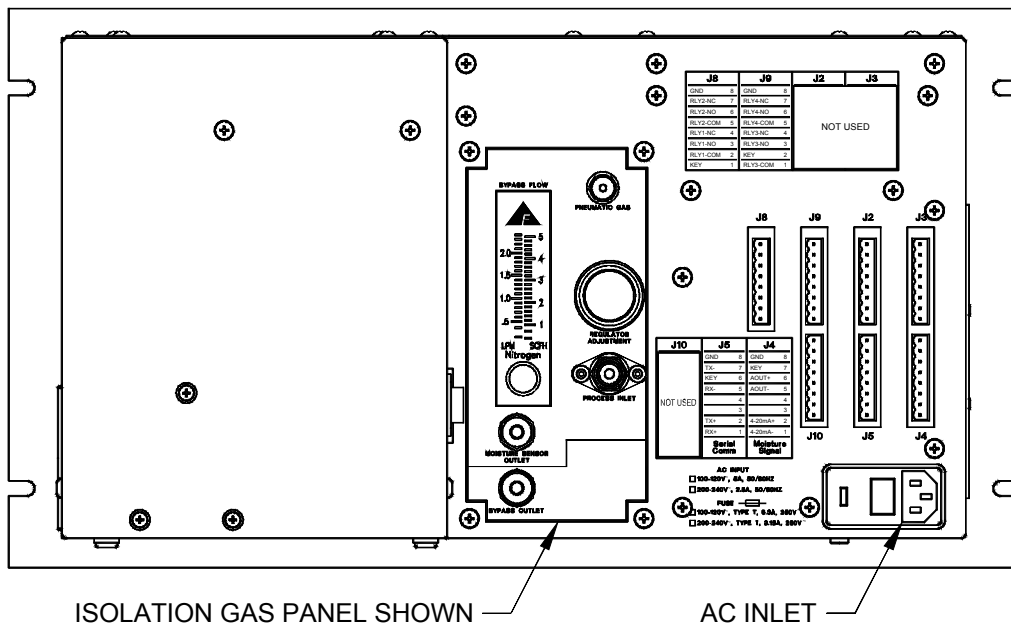

Figure 7: AC Power Connections with Optional Gas Panel

## 4.2 Analyzer Start Up

It is important to note that, if equipped with automatic gas valves, the moisture cell is isolated from gas flow while the analyzer is off power.

Open the door and turn on the power using the main power switch inside the analyzer. See Figure 2. The pump, if equipped, should turn on (see page 17) and the analyzer will undergo a series of Diagnostic Procedures while the various startup screens are displayed. Next, the Delta F Corporation logo is briefly displayed and then the data display appears with the “Warming Up” screen flashing. The warm up process takes approximately six to ninety minutes after which the display will look similar to Figure 8 (values shown are only representative).

During the Warm Up process the gas valves (if equipped) can be opened and gas flow started. See the section on Gas Pressure and Flow Settings on page 20 for important information on the gas delivery system and setting proper pressures and flow rates.

### NOTE



During the warm up period all analog and digital outputs are held to an artificial 0.011 ppb reading to avoid the reporting of false readings.

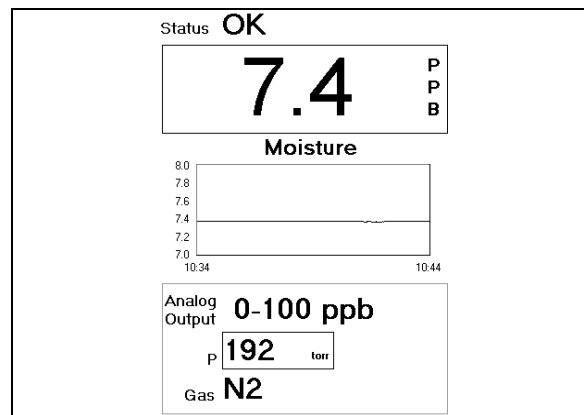

Figure 8: Data Display Screen

### 4.2.1 Gas Delivery System

The gas delivery system as shown in Figure 9 is designed to deliver a gas flow rate of 2 liters per minute to the moisture cell while maintaining the highest standards of gas purity and delivery for ultra-trace analysis. Features include a single inlet line and flow meter for the gas sample, and optional bypass loop to maintain constant purging, and essentially dead-leg free delivery.

The connections at the rear of the gas delivery system include a 1/4" VCR swivel connection for the process inlet, a 1/4" compression outlet for the moisture cell, an optional pneumatic gas connection (1/8" compression), and an optional 1/4" compression outlet for the bypass loop. Also on the rear of the gas delivery system, if equipped, are a sample gas regulator to adjust the internal sample pressure and a bypass flow meter.

The moisture cell outlet will be connected to the supplied aspirator or, if equipped, to the vacuum pump.

The sample inlet to the moisture analyzer, as well as the zero gas inlet, are heated to 60 C. This is done to mitigate any effects of adsorption-desorption of trace moisture on the walls of the tubing.

## 4.2.2 Gas Pressure and Flow Settings

Attention to the setting of gas pressure and flow is critical to proper operation of the analyzer. If all steps are followed carefully at the time of start up, subsequent changes to flow or background gas will be made easier. The following procedure assumes all electrical and plumbing connections have been made according to instructions in this manual. In addition, this procedure assumes a Nitrogen gas background unless otherwise noted.

1. Power up the unit. See page 19. If the unit is equipped with a Hydrogen Safety System, no flow will enter the system until the unit is on power.
2. Ensure that the needle valve on the aspirator is fully open.
3. For a basic analyzer with no cell isolation valves installed,
  - a. simply provide sufficient pressure (5-30 psi), resulting in a flow of 1 slpm (2 scfh) as indicated on the flow meter located behind the front door. NOTE: The flow rate will directly impact the overall system speed of response.
  - b. Turn on the vacuum source (aspirator) by applying gas to the high pressure inlet. See Figure 3. (Except when measuring in Helium background which is not run under vacuum but at ambient) NOTE: Once the vacuum source is connected and running, proper flow is indicated by a full scale reading on the flowmeter.
  - c. Go to step 5.
4. For analyzers equipped with optional cell isolation valves:
  - a. Completely open (turn fully clockwise) the inlet regulator on the rear of the analyzer. For operation in Nitrogen, Argon and Oxygen the regulator is closed (turned counter clockwise) to the approximate middle, or 50% of its range. For operation in Helium and Hydrogen it should be closed to 80-90% of its range resulting in a flow of 1 slpm (2 scfh) as indicated on the flow meter located behind the front door. NOTE: The flow rate will directly impact the overall system speed of response.
  - b. Open the flowmeter bypass valve on the rear of the analyzer and flow in the bypass loop will be indicated on the flowmeter. Adjust the flowmeter bypass valve to 0.5 slpm. See Figure 5.
  - c. Purge for 15 minutes before opening gas valves to the moisture cell.
  - d. The state of the gas control valves is indicated on the main display. The default state of a factory-shipped instrument is isolation. This can be adjusted in the Power Up Default section. If the moisture cell is isolated, establish process flow via the Main menu. See page 38.



- e. Use the regulator to adjust the flow through the cell to 1 slpm (2 scfh) as shown on the flowmeter behind the front door. NOTE: This flow rate may be reduced to minimize gas consumption but the flow rate will directly impact the overall system speed of response.
  - f. Confirm that the needle valve on the vacuum source (aspirator) is fully open (CCW).
  - g. Turn on the vacuum source (aspirator) by applying gas to the high pressure inlet. See Figure 3. (Except when measuring in Helium background which is not run under vacuum but at ambient)
5. At this point, some adjustment of the aspirator needle valve may be necessary to achieve the necessary operating cell pressures for each gas (except Helium where there is no vacuum operation). The proper pressure ranges listed in Table 1 will automatically appear on the display when the GSF is selected.

Background Gas	Pressure	Vacuum Source
N2	150 - 250 Torr	ON
Ar	280 - 380 Torr	ON
He	740 - 780 Torr	OFF*
H2	300 - 400 Torr	ON
O2	300 - 400 Torr	ON

\*A shut off valve must be installed at the inlet to the aspirator to disable the vacuum.

Table 1: Recommended Sample Outlet Vacuum Pressure

### 4.2.3 Download System Data

The final step of the installation, after a couple days of dry down, should be to download the system data (see page 65), and send them by e-mail to [service@delta-f.com](mailto:service@delta-f.com) for review. This will allow the factory to confirm that the analyzer is working properly by comparison with data stored at the time of shipment, and in addition will set a baseline for comparison with future downloads, if any.

## 4.3 Analyzer Shut Down

In order to minimize the time required for the analyzer to re-achieve a zero baseline on start up, the following steps should be followed when shutting the analyzer down.

**Short Term Shut Down** - A short-term shut down, for example to move and restart the analyzer, can be accomplished by simply shutting off the power switch behind the front door. This action initiates the standard isolation process (for analyzers equipped with gas control valves) and computer shut down which takes approximately 40 seconds.

**Long Term Shut Down** – For analyzers with gas control valves, from the Main Menu go to System, and select Isolate Analyzer. A routine automatically starts that closes the downstream valve and allows pressure to build in the moisture cell after which an upstream

valve closes as well. Throughout this process a message appears over the display instructing the user to wait 40 seconds. Once complete, the message disappears and the user may shut the power off with the switch behind the front door that initiates the computer shut down sequence that takes an additional 40 seconds.

Additional long-term isolation security can be achieved by closing the valve on the rotameter on the rear of the instrument as well as completely closing the sample inlet regulator.

If the analyzer is being disconnected from gas, be sure to tightly cap all gas connections.

On analyzers that have no gas control valves:

1. Remove the vacuum source.
2. Wait a few minutes to allow positive pressure to build in the moisture cell and monitor the pressure on the Main Display.
3. Be sure to tightly cap all connections.

NOTE: See the section on Power up Default on page 63 for setting user selectable preferences at the time of power up.

Loss of power will result in automatic valve closure and the following restoration of power will result in the “Scan Disk” function occurring before system start-up.

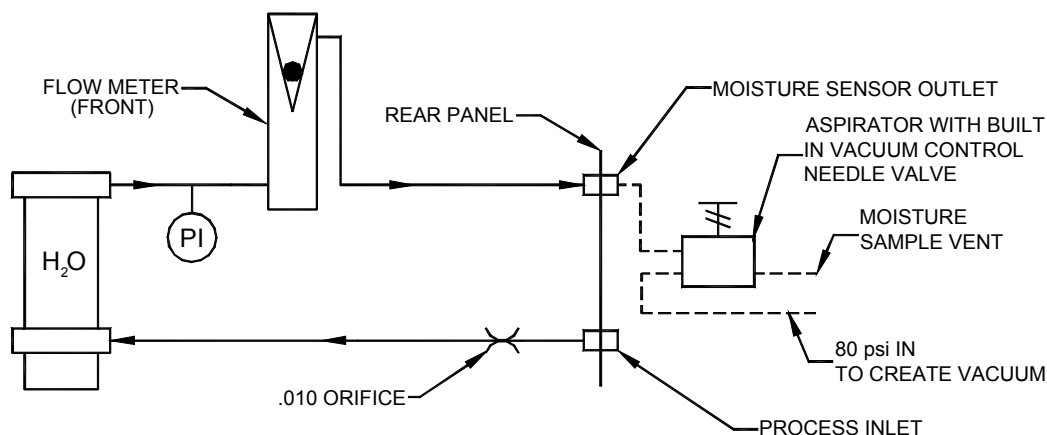

Figure 9: Block Diagram of Gas Flow Path and Aspirator

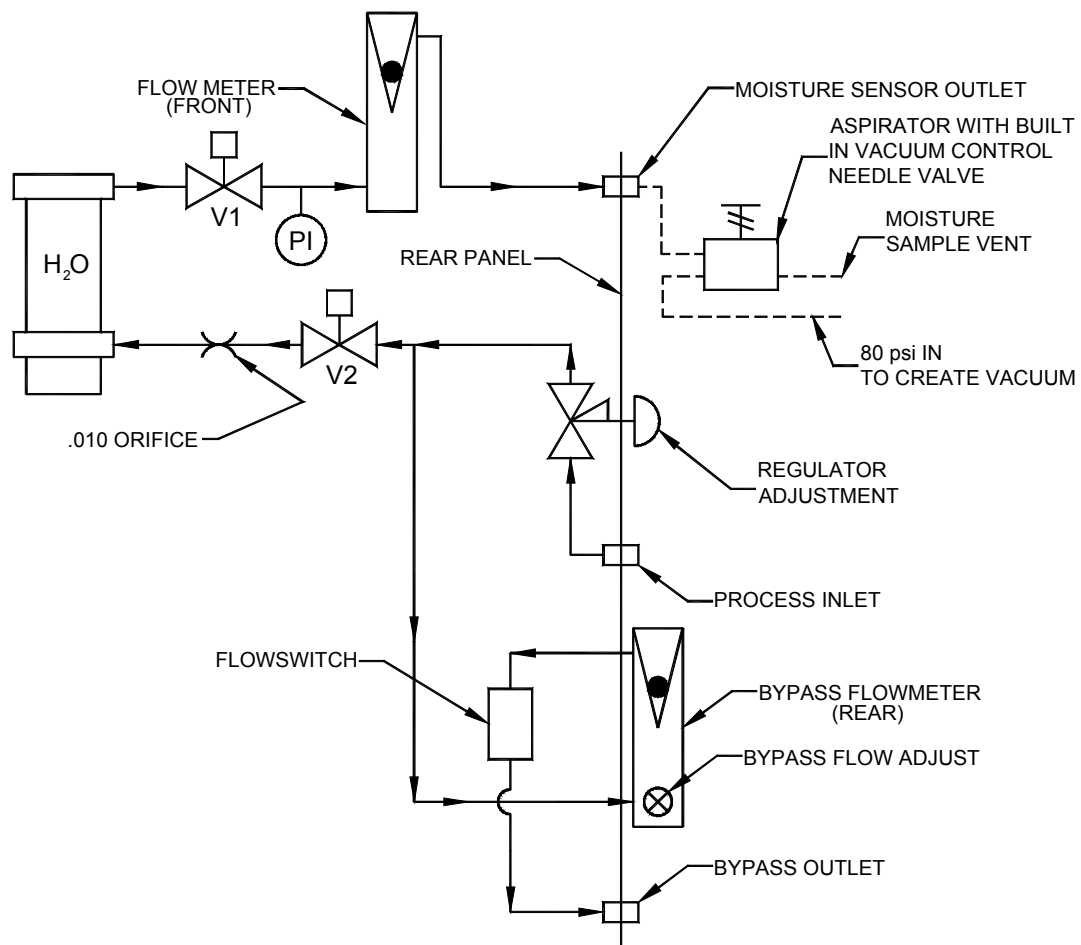

Figure 10: Block Diagram of Gas Flow Path with Optional Valves and Aspirator



# 5 Options

The following options to the DF-745 are available at the time of order.

## 5.1 Key Lock

An optional key lock can be installed in the door of the analyzer to prevent access to the power switch and other internal components. The lock is supplied with two keys.

If the analyzer is operating, the key lock does not prevent adjustments from the front panel.

## 5.2 Operating Voltage

The analyzer can be wired for operation at either 100-120 Volts AC or 200-240 Volts AC.

The operating voltage is not adjustable in the field.

## 5.3 Serial Communications

The analyzer can be set for communications by RS-232 or RS-485.

The serial communications option is not adjustable in the field.

See page 31, 65 and 67 for additional information.

## 5.4 Analog Voltage Output

The maximum analog voltage output can be set at the factory for 0-1, 0-2, 0-5 or 0-10 Volts DC.

The maximum analog voltage output is not adjustable in the field.

See page 32 and 55 for additional information.

## 5.5 Hydrogen Service Safety System

This option enables the analyzer to be safely used in a hydrogen background application.

See page 89 for additional information.

## 5.6 Vacuum Pump

An optional pump can be purchased to replace the aspirator in cases where there is insufficient gas flow for the aspirator or when the analyzer is installed in a portable cart and connection to an air supply is inconvenient.

NOTE: If a pump is being retrofitted to an analyzer configured with an aspirator, then the aspirator assembly must be removed completely to uncover the pump power connector and

breaker switch. The pump connection should be made directly to the Moisture Sample Outlet as described in section 5.6.2.

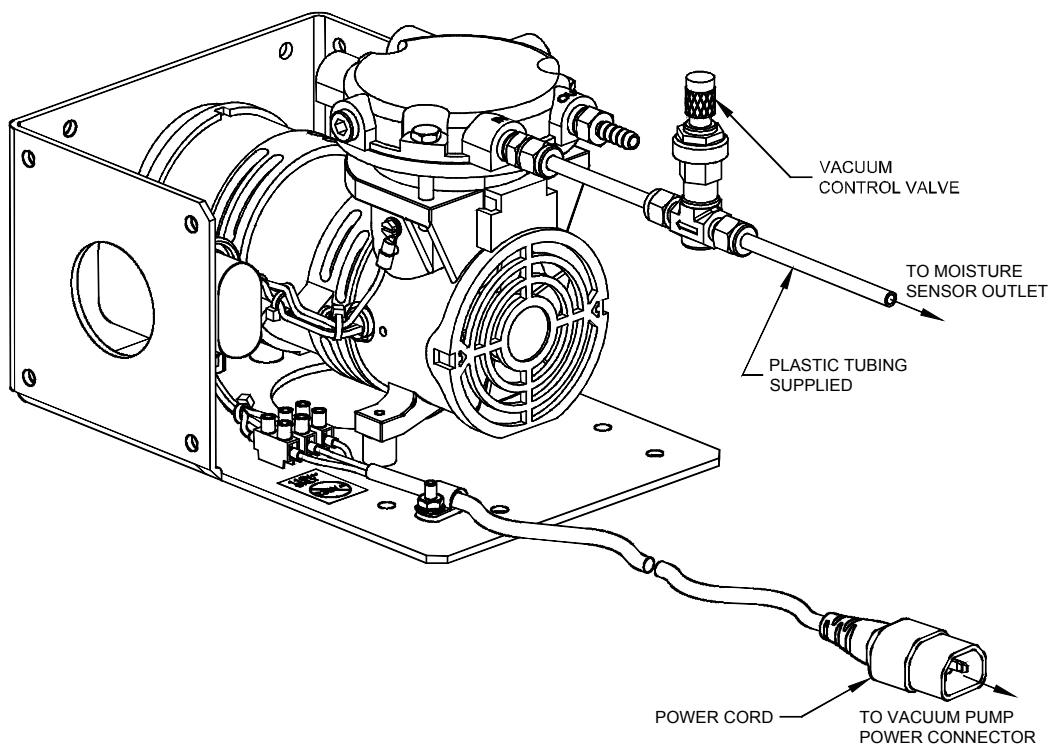

Figure 11: Vacuum Pump Assembly

### 5.6.1 Installation of the Vacuum Pump

- Mount the vacuum pump to the bracket
- Connect the line from the moisture sample outlet to the needle control valve and vacuum pump
- Make the electrical power connection to the vacuum pump

#### 5.6.1.1 Vacuum Pump Mounting

Mount the vacuum pump within 8 feet of the analyzer. Refer to Figure 12 and Figure 13 for mounting hole and pump dimensions.

#### CAUTION



Be sure the pump outlet is at atmospheric pressure before starting. The pump is not designed to start against any backpressure.

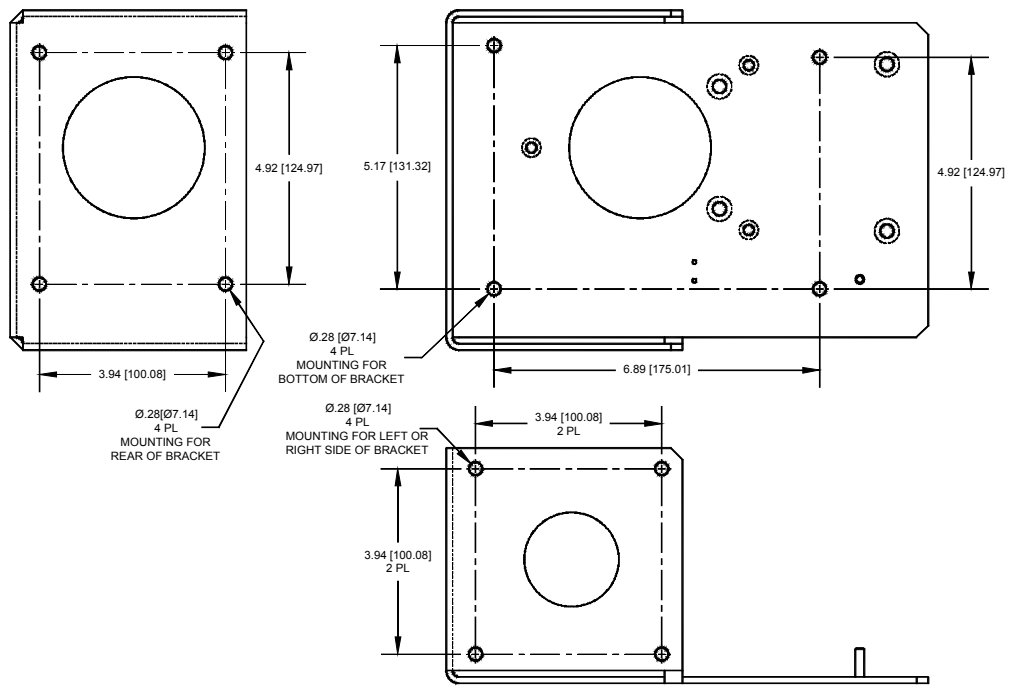

Figure 12: Vacuum Pump Mount Dimensions

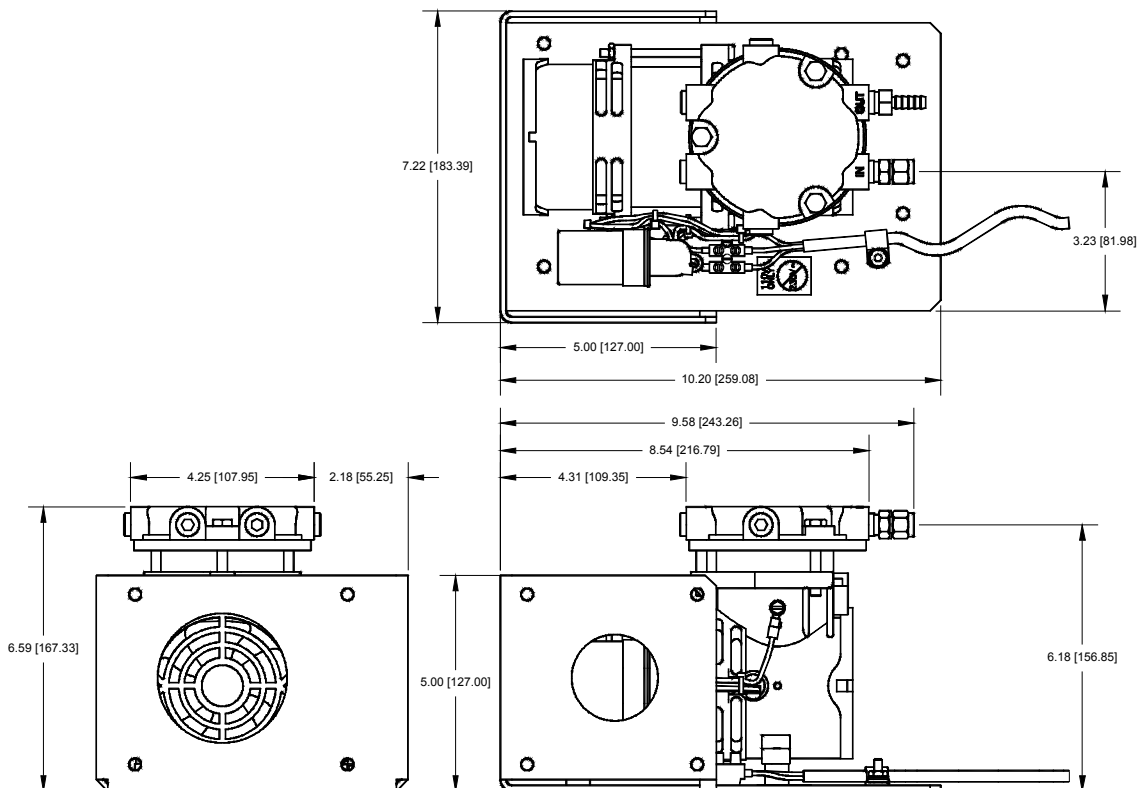

Figure 13: Vacuum Pump Dimensions

## 5.6.2 Moisture Sample Gas Outlet Connection to Vacuum Pump

The sample gas outlet connection is a ¼ inch compression fitting labeled Moisture Sensor Outlet as shown in Figure 4 and Figure 5. Use the polyethylene tubing provided with the analyzer to connect between the outlet fitting and the ¼ inch fittings on the needle control valve and vacuum pump (included separately). See Figure 11. **Open the needle control valve completely.**

NOTE: If the Hydrogen Service Safety System is included, the sample outlet line must be made of steel. See page 89 for additional information.

## 5.6.3 Electrical Connections

Plug the vacuum pump power cord into the vacuum pump power receptacle on the rear of the analyzer. Turn on the vacuum pump power breaker that is adjacent to the receptacle. The pump will not turn on until the main analyzer power switch is turned on. See Figure 14.

NOTE: The voltage supplied at the vacuum pump power connector is the same as the input voltage to the analyzer. For example, if 110VAC is supplied to the analyzer then 110VAC is supplied to the pump.

### CAUTION



Be sure the pump outlet is at atmospheric pressure before starting.  
The pump is not designed to start against any backpressure.

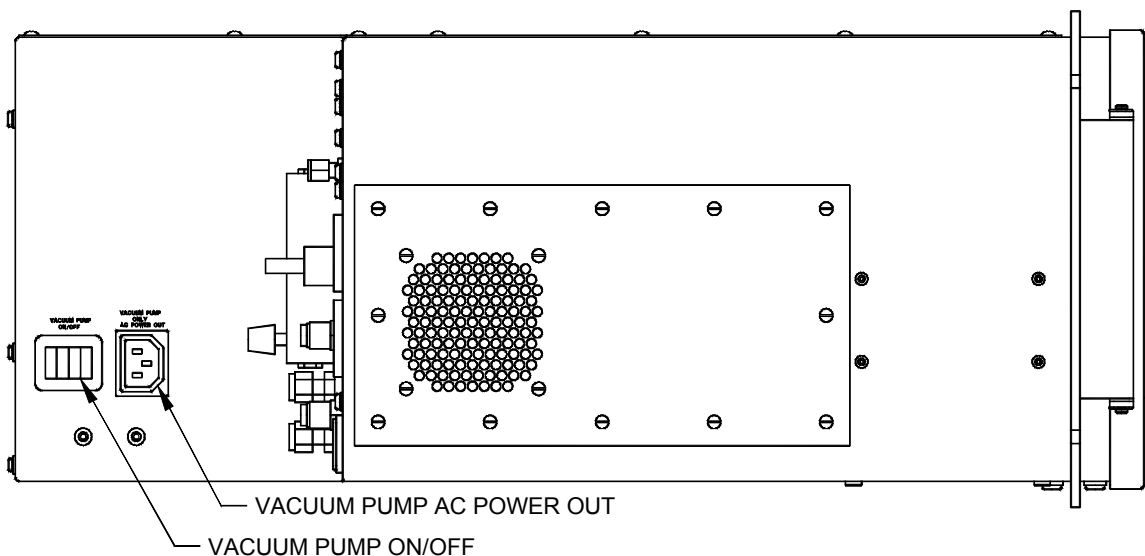
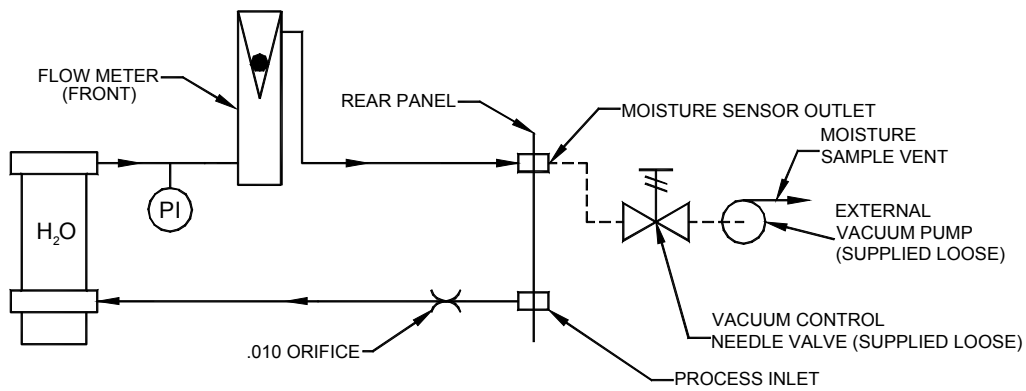
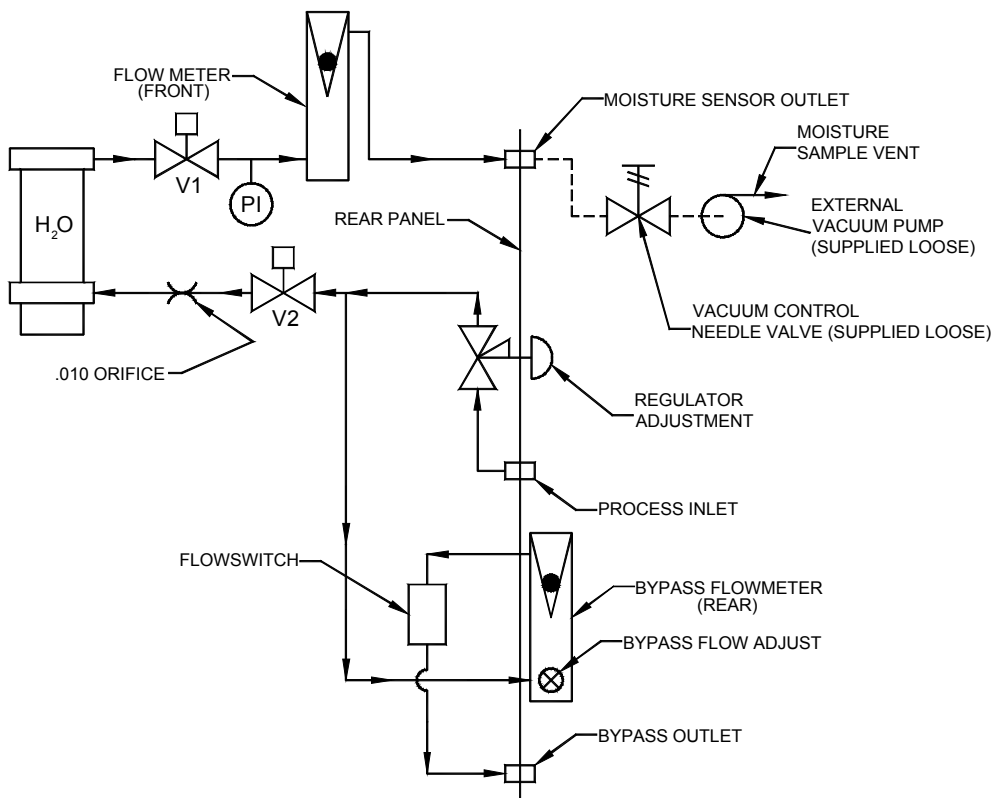

Figure 14: Vacuum Pump Power Connections and Controls





**Figure 15: Block Diagram of Gas Flow Path and Optional Vacuum Pump**



**Figure 16: Block Diagram of Gas Flow Path with Optional Valves and Vacuum Pump**



# 6 Connecting to External Devices

The analyzer can be interfaced to a variety of external devices via the ports on the rear panel. Alarm contacts, voltage, and current outputs, and serial communications are supported. All outputs, analog or digital, are fully isolated from earth ground.

## NOTE



During the six minute warm up period all analog and digital outputs are held to an artificial 0.011ppb reading to avoid the reporting of false readings.

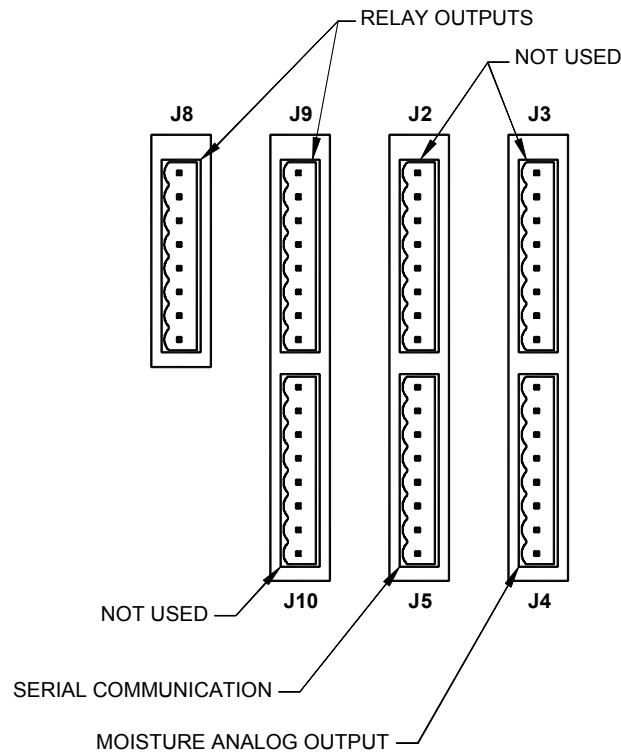

Figure 17: Rear Panel Electrical Connectors

## 6.1 Serial Communication Port – J5

Either of two serial communication ports are available at the time of order: RS232C or RS485 which enable interface between the analyzer and other operating systems.

Up to 32 units may be accessed via RS-485. Operating parameters are 8 bits, no parity, and one stop bit. Baud rate may be selected from the menu on the display.

See Table 2 on page 32 for wiring information.

See the chapter on Communications on page 65 for additional information on setting unit ID's and baud rates.

A program to facilitate serial communications is available from Delta F.

Pin #	Signal	Description
J5-8	GND	Ground
J5-7	TX-	4 wired 485 paired with TX+
J5-6	Key	Unused
J5-5	RX-	4 wire 485 paired with RX+
J5-4		Unused
J5-3		Unused
J5-2	TX+	Data transmitted by the analyzer via RS-232 or RS-485
J5-1	RX+	Data received by the analyzer via RS-232 or RS-485

Table 2: Pin-out of Serial Comm Connector J5

Pin assignments			
DF-760/750	PC-DB9/RS-232	PC-DB25/RS-232	PC/RS-485 converter
1: RX+	3: TD	2: TD	TX+
2: TX+	2: RD	3: RD	RX+
8: Gnd	5: Gnd	7: Gnd	
5: RX-			TX-
7: TX-			RX-

Table 3: Serial Communications Connections

## 6.2 Analog Signal Outputs – J4

The analog voltage output correlating to the front panel display reading is provided on the rear of the analyzer through connector J4. The full scale voltage is set at the factory at the time of order to: 0 to 1 VDC, 0 to 2 VDC, 0 to 5 VDC, or 0 to 10 VDC. The output is electrically isolated from all other analyzer outputs, and from chassis (Earth) ground. See page 55 for additional information on setting the Analog Output. The output may be tested with the use of the analog voltage test routine found on page 59.

## 6.3 4-20 mA Outputs – J4

J4 Pin #	Moisture Signal	Description
J4-8	GND	Ground
J4-7	Key	
J4-6	A Out +	Analog Voltage Output (+)
J4-5	A Out -	Analog Voltage Output (-)
J4-4		Unused
J4-3		Unused
J4-2	4-20 mA +	4-20 mA Output (+)
J4-1	4-20 mA -	4-20 mA Output (-)

Table 4: Pin-Out of Moisture Signal Output Connector J4

The 4-20 mA analog output correlating to the front panel display reading is provided on the rear of the analyzer through connector J4. This output is electrically isolated from all other analyzer outputs, and from chassis (Earth) ground.

The maximum load resistance for each is 1K Ohms and the analyzer provides a compliance voltage of approximately 28 VDC.

## 6.4 Relay Ports – J8, J9

Four form C (SPDT) relays (contact closures) are provided to assign to the various alarms. The contacts are rated at 30 VDC, 1A. They are not designed to switch AC power.

The relay contacts can be programmed through the user interface for up to four moisture levels, temperature, moisture cell diagnostics, zero calibration in progress, analyzer off line, freeze of analog outputs during calibration.

The relays are wired for Fail Safe operation such that a Normally Open (No alarm) contact connects to common when an alarm occurs or when power to the instrument is lost.

The relay wiring can be tested with the Relay test routine found on page 57.

Pin #	Moisture Relay	Description
J8-8	GND	Ground
J8-7	RLY2-NC	Relay 2 Normally Closed
J8-6	RLY2-NO	Relay 2 Normally Open
J8-5	RLY2-COM	Relay 2 Common
J8-4	RLY1-NC	Relay 1 Normally Closed
J8-3	RLY1-NO	Relay 1 Normally Open
J8-2	RLY1-COM	Relay 1 Common
J8-1	KEY	Unused
J9-8	GND	Ground
J9-7	RLY4-NC	Relay 4 Normally Closed
J9-6	RLY4-NO	Relay 4 Normally Open
J9-5	RLY4- COM	Relay 4 Common
J9-4	RLY3-NC	Relay 3 Normally Closed
J9-3	RLY3-NO	Relay 3 Normally Open
J9-2	Key	Unused
J9-1	RLY3-COM	Relay 3 Common

Table 5: Pin-Out of Relay Connectors J8 and J9



# 7 User Interface

## 7.1 Data Display Screen

The front panel display consists of the Graphical User Interface (GUI), as displayed on the view screen in Figure 18 below.

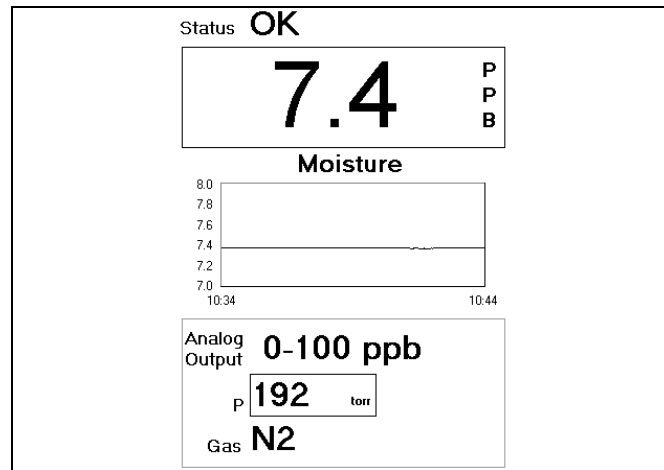

Figure 18: Data Display Screen

The various elements of the main data display screen are as follows:

- Alarm status indicator – ‘1, etc.’ denotes an alarm condition (if enabled), ‘OK’ denotes no alarm conditions (if enabled).
- The Data Line, providing the most recent concentration measurement in the large number display. This box will also provide indication of abnormal operating conditions for each sensor.
- A strip chart history of concentration measurements.
- A ppb output range, for the analog outputs, as designated by the user.
- Gas pressure within the moisture cell.
- Background gas as set by the user

The digital readout of moisture concentration will be over written with a warning if any of the four moisture level or system alarms are tripped.

## 7.2 Keypad

The keypad allows the user to control all of the features of the analyzer. The layout of the keypad on the front panel is represented in Figure 19.

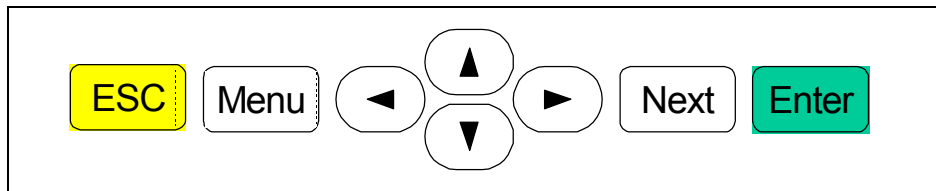

Figure 19: Keypad

The 'Menu' key activates the menu structure along the top of the GUI interface on the view screen.

Once in the menu, the arrow keys (▲ and ▼) highlight the various menu features. When the desired selection is highlighted, the right arrow will access the submenu if available (denoted by a right arrow next to the menu text). The 'Next' key and the 'Enter' key will do this as well. The arrows also enable the entry of numerical parameters as will be described below.

The 'Enter' key will call up dialogue boxes from the menu (denoted by the sequence ... next to the menu text). It will also enter numerical values within dialogue boxes.

The 'Next' key allows the user to change between active inputs within a dialogue box. The down arrow key will also accomplish this activity.

The 'ESC' key allows the user to exit numerical entry boxes within dialogue boxes without any user changes, dialogue boxes without any user changes, and the menu bar.

## 7.3 Menu Structure

A bar along the top of the GUI interface on the view screen is reserved for the menu control of the instrument. The NanoTrace Moisture Analyzer menu tree consists of main menus, sub-menus and screens and is depicted below. See Appendix A on page 85 for a summary of the available menus.

## 7.4 Main Menu



Figure 20: Main Menu



The Main Menu is accessed by pressing the Menu key on the front panel. Use the arrow keys (▲ and ▼) to navigate up and down through the list. Select the highlighted item with the Enter key on the front panel.

If a menu item is grayed out as shown in Figure 21, then the option is not installed, and as a result the item is not available.



Figure 21: Main Menu (without valve option)

### 7.4.1 Isolate Analyzer – Optional



Figure 22: Isolate Analyzer

Isolate Analyzer allows the internal gas lines and the moisture sensing cell volume to be isolated in the case of an impending break in the external delivery lines. It is also considered the first step in the shut down procedure. Highlight this item and hit the Enter key to initiate the isolation process. The Isolate Warning shown in Figure 23 will appear for 40 seconds.

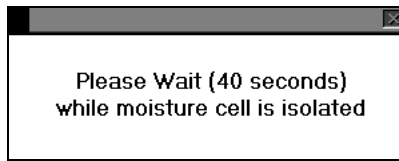

Figure 23: Isolate Warning

While the moisture cell is isolated from gas flow, a warning will appear at the bottom of the main display indicating “Isolated”.

## 7.4.2 Restore Sample Gas Flow – Optional



Figure 24: Restore Sample Gas Flow

This command allows the user to return the analyzer gas flow to normal after isolation.

## 7.4.3 Calibrate Menu

“Calibration” of the moisture analyzer is somewhat of a misnomer. Because of the nature of absorption measurements, instrumental drift has minimal effect on the quantitative moisture content result. Once operating parameters are in place from the factory, no other *SPAN* “calibration” is necessary.

However, line contributions to offsets in ppb measurements, especially at the sub-ppb level, are difficult to remove even with a correctly operating system. The moisture analyzer has an array of zeroing features that enable the user to establish performance near 0.0 ppb.

Any zero action whether completed or aborted is recorded in the **Zero Cal Log** as shown in Figure 40.

Use the arrow keys (▲ and ▼) to scroll up and down through the list. Pressing ESC will return to the main display.



Figure 25: Calibrate Menu

### 7.4.3.1 Check/Adjust Zero

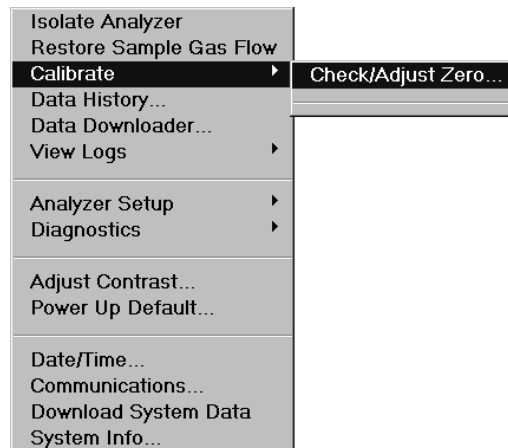

Figure 26: Check/Adjust Zero Menu

The Check/Adjust Zero screen displays many pieces of information including a live reading of moisture in ppb (or ppm) and the state of the zero gas control valves. Also depicted are Zero Reference and Zero Offset values.

The Zero Reference value is a reflection of the deviation of the instrument's baseline from what was set at the factory. The zero reference of an instrument from the factory will be 0.00. After a manual or auto zero is performed, this value may change slightly.

If the moisture cell has been previously calibrated by the user, Restore Factory Zero will be enabled on this screen. Enacting this will erase any user zero and restore the factory set point.

The User Zero Offset and Active Zero Offset are two mechanisms to modify the zero baseline. When the Active Zero feature is turned on, the User Zero Offset display is inactive and Active Zero Offset will be displayed instead. See page 57 for additional information on the Active Zero feature.

A relay is available on the Analog Output Setup Screen (see page 55) to signal that a zero calibration is taking place, and the analog output signal can also be frozen or allowed to update during the calibration process.

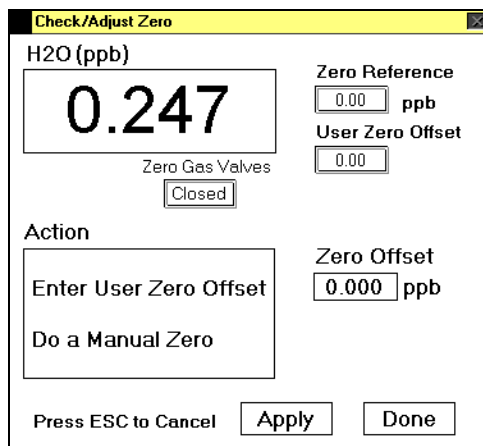

Figure 27: Check/Adjust Zero Screen

#### 7.4.3.1.1 User Zero Offset

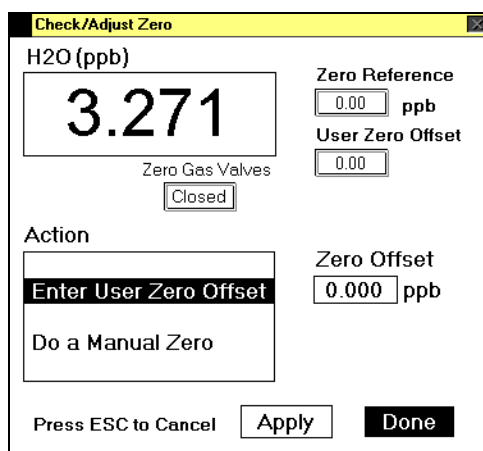

Figure 28: User Zero Offset

The User Zero Offset function enables the user to add a given moisture ppb value to the displayed concentration. This can be useful in preventing negative readings to be displayed should the baseline drift below the calibrated zero point. The value does not affect zero calibration, it is simply added to the calibrated zero. For example, an offset of 1.0 ppb could be put into a system reading 0.0 ppb to allow a chart recorder attached to the output to read slightly above zero. Under this condition, the moisture reading would be 1.0 ppb.

Use the arrow keys (▲ and ▼) to highlight Enter User Zero Offset in the Check/Adjust Zero screen, Figure 27, hit the Enter key on the front panel, and the zero offset box will appear on the screen as shown in Figure 28. With the left and right arrow keys move the cursor to the right of the digit you want to change. With the up and down arrow keys set the number to the desired value. When done hit the Enter key which will move the highlighted area to the Apply button and hit Enter to set the value. Use the Next key to go

back and change the value or move to the Done button, followed by hitting the Enter key to leave the screen. Using the ESC key at any time will exit the screen making no changes and return to the main display.

#### 7.4.3.1.2 Do A Manual Zero

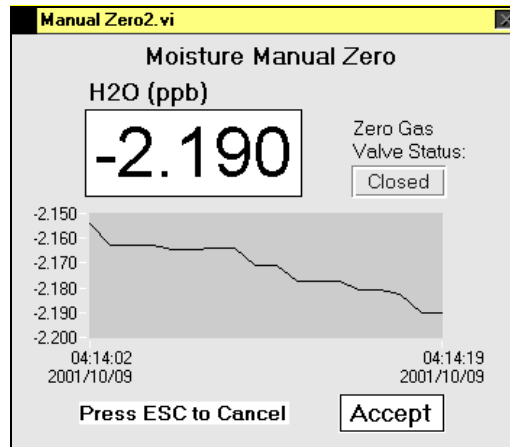

Figure 29: Manual Zero Screen

The manual zero command enables the user to zero the moisture cell in an interactive manner.

For this purpose, it is necessary to ensure that moisture free gas (sub ppb) is entering the sensor through the process inlet. When switching to a gas that is moisture free, it is important to wait a period necessary to allow the reading to re-stabilize.

It is extremely important to note that moisture is inherently slow to move and as a result the process of doing a zero action can take many hours before the reading is at baseline. A premature zero, although acceptable, will ultimately result in a negative reading as the plumbing and analyzer continue to dry out requiring another zero action. See the section on Active Zero on page 57 for additional information.

After selecting Do a Manual Zero, a screen will appear which displays a trace of the recent moisture reading. See Figure 29. Observe the trace until the reading is stable and then press Enter. This action will accept the present value as the new zero setting for the moisture cell and the Zero Reference field will be updated. After this action, the user will be brought back to the Check/Adjust Zero screen.

Pressing ESC during the calibration process will abort the action and return to the main display. Whether the calibration is complete or aborted, pressing Done from the previous screen will allow the user to return to the main display.

Once complete the gas source must be returned to the original state with process gas going directly through the sensor.

A relay is available on the Analog Output Setup Screen (see page 55) to signal that a zero calibration is taking place, and the analog output signal can also be frozen or allowed to update during the calibration process.

## 7.4.4 Data History Routine



Figure 30: Data History Menu

The Data History Screen (Figure 31) enables the user to see the data history displayed in strip chart form on the front display. By default, the data history screen displays data for the most recent 24 hour period sampled at 1 point per minute (fixed) and the y-axis is auto-scaling.

The **Next** button can be used to toggle the X axis from 1 day (default), to 1 hour, to 1 week and then to 3 weeks.

The **Next** button can also toggle the cursor to the max and min values on the Y axis and the arrow keys can then be used to adjust the values, and the display will actively update.

The data history may be downloaded to a USB memory stick, by using the **Next** key to move to the **Download** box and hitting **ENTER**. A screen will appear, requesting that a memory stick can be placed in the external USB socket. The socket is located behind the front door on the left side of the chassis.

The downloaded file will be in tab delimited form and will be all moisture data in the system up to 3 weeks old if available. The download process will take up to 15 seconds and the display will indicate downloading is in progress. Once the download is complete, control of the analyzer is returned to the operator. See Figure 33 for an example of a portion of a download taken between the dates of May 1 and May 22. The complete file covers three full weeks.

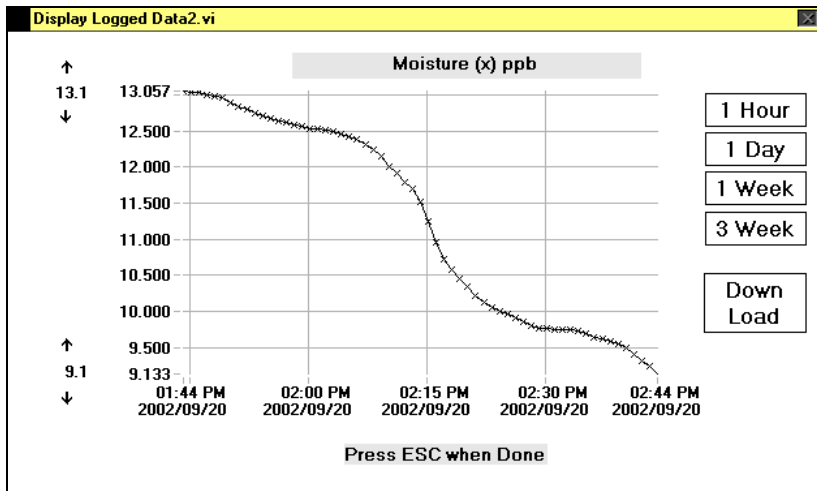

Figure 31: Data History Screen

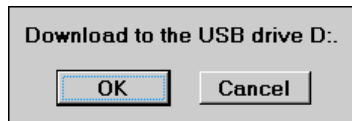

Figure 32: Install Media

```

Firmware version  0.6.1
Serial #         ND-10016
Model #         DF-745
Start time      05-01-2003 03:07 PM
End time       05-22-2003 03:07 PM
Date          Time          H2O
5/16/03      1:24 PM       5.423
5/16/03      1:25 PM       5.423
5/16/03      1:26 PM       5.421
5/16/03      1:27 PM       5.416
5/16/03      1:28 PM       5.411
5/16/03      1:29 PM       5.406

```

Figure 33: Example of Data Download

## 7.4.5 Data Downloader Routine

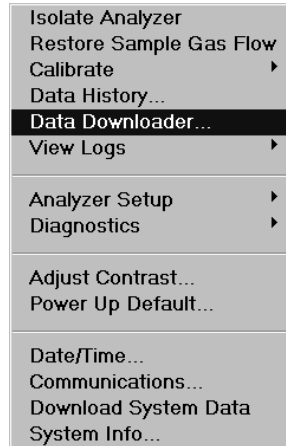

Figure 34: Data Downloader Menu

The Moisture Data Downloader screen, Figure 35, enables the user to label data with unique location names as well as to view and download specified data.

The **Next** key is used to toggle through the various options on the screen and the arrow keys (▲ and ▼) move up and down through the location list.

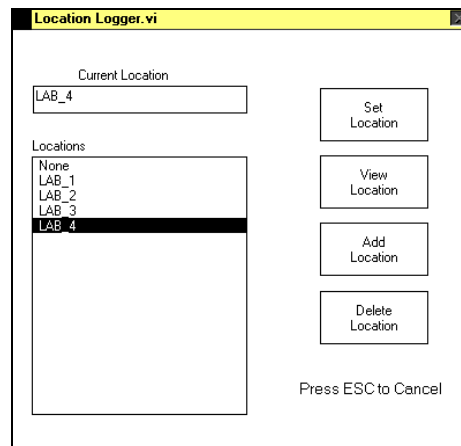

Figure 35: Data Downloader Screen

### 7.4.5.1 Set Location

The set location function is used to choose a location from a list of existing locations previously entered into the system (see Add Location on page 45). On the Moisture Data Downloader screen Figure 35, use the **Next** key to move to the list of existing names and then use the arrow keys (▲ and ▼) to select the location desired. Then use the **Next** key to move to **Set Location** and press **Enter** to accept the new location.

The action of setting a location starts the logging process and creates a new file. Changing to a new location will, in turn, end the previous file and start a new one.



### 7.4.5.2 View Location

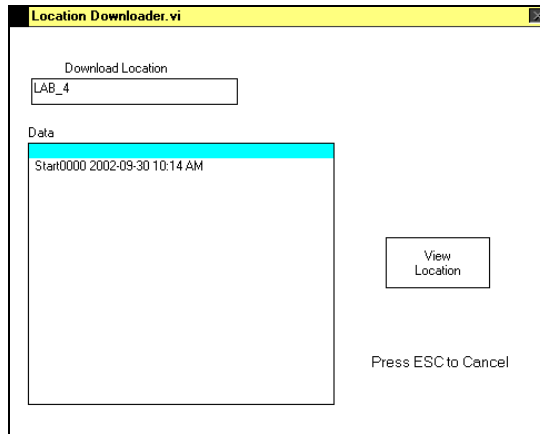

Figure 36: View Location Screen

The view location function is used to view data previously stored in the system sorted by location. On the Moisture Data Downloader screen Figure 35, use the **Next** key to move to the list of existing names and then use the arrow keys (▲ and ▼) to select the location desired. Then use the **Next** key to move to **View Location** and press **Enter**. The View Location screen will appear as in Figure 36.

Use the arrow keys (▲ and ▼) to select the data block desired and use the **Next** key to move to **View Location** and press **Enter**. The data history screen will appear as shown in Figure 31. From the data history screen, the data may also be downloaded to a USB memory stick.

### 7.4.5.3 Add Location

The user can create a new location stamp by moving the cursor to the **Add Location** button and hitting enter. This brings up the keyboard shown in Figure 37 that is used to enter the name of the new location.

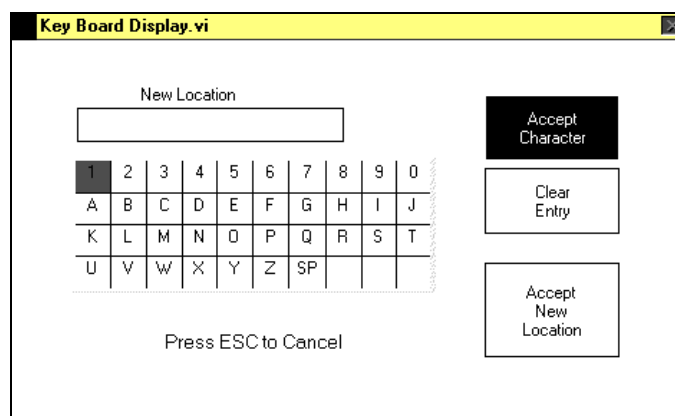

Figure 37: Keyboard Display

Use the arrow keys (▲ and ▼) to navigate the keyboard and use the Enter key to accept each character. If an error is made use the Next key to move to the Clear Entry key and hit enter. When the location name is complete use the Next key to move the highlight to Accept New Location and hit Enter. The display will return to the Downloader Screen and the name will appear in the list of available locations.

#### 7.4.5.4 Delete Location

The delete location function is used to remove a location from the list of available names. On the Moisture Data Downloader screen Figure 35, use the Next key to move to the list of existing names and then use the arrow keys (▲ and ▼) to select the location desired. Then use the Next key to move to Delete Location and press Enter. A confirmation box will then appear (see Figure 38) and the user can either accept the deleted selection with the Enter key or can hit ESC to cancel the action. If accepted, the name will be removed from the list of available locations.

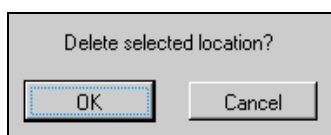

Figure 38: Delete Selection

#### 7.4.6 View Logs Menu

View Logs allows the user to easily access past events that may be connected with past operational changes (e.g., zero) or instrument upsets. Use the arrow keys (▲ and ▼) to scroll up and down through the list. Pressing ESC will return to the main display.

##### 7.4.6.1 Zero Log

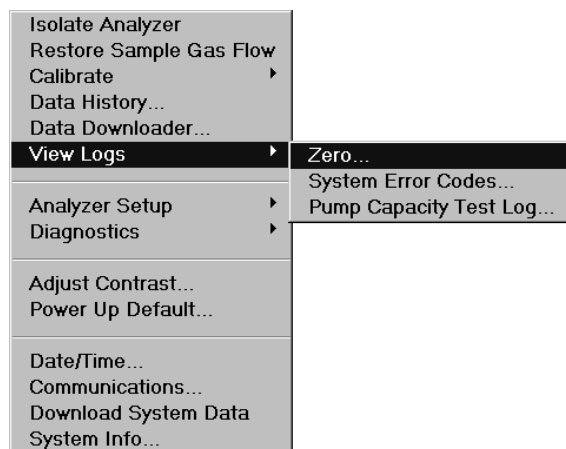

Figure 39: View Zero Log Menu

The Moisture Zero Log reports on adjustments made to the moisture cell zero setting. The date and time of the zero calibration is noted. The zero is listed as either Manual or Automatic. Notes are also given as to if the zero was aborted, failed due to timeout, or in

the event of an Automatic Zero, if it were scheduled. The time to perform the zero and the resulting zero reference are also noted.

Date & Time	Notes	Min	ZRef
07/17/2001 13:07	Manual zeroAborted	0.2	NaN
07/16/2001 13:00	Manual zero	0.0	29.55
07/16/2001 12:54	Manual zero	0.1	30.35
07/16/2001 12:54	Manual zero	0.1	31.06
07/16/2001 12:46	Manual zero	0.1	8.51
07/16/2001 12:38	Manual zeroAborted	0.5	NaN
07/16/2001 12:37	Manual zero	0.2	28.67
07/16/2001 12:36	Manual zero	0.1	28.78
07/16/2001 12:32	Manual zero	0.1	-2.61

↓more  
Press ESC when Done

Figure 40: Zero Log Screen

#### 7.4.6.2 System Error Code Log

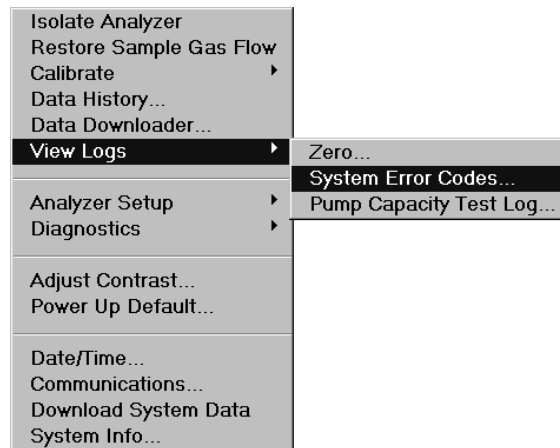

Figure 41: View System Error Code Log Menu

The System Error Log reports functional errors in the moisture system. If the error persists for more than 30 minutes, the code is displayed, if warranted. In addition, a system alarm will trip if configured to do so. See page 54 for additional information on setting System Alarms.

NOTE: The 30 minute clock is delayed for 60 minutes on a “cold” system start up.

Following is a list of System Error/Event Codes and their descriptions:

- 101 = peak unstable or not found
- 133 = data acquisition system event
- 141 = sample gas pressure outside of pressure matrix range.
- 191 = fan condition voltage out of range – “Fan Failure”

Contact Delta F for assistance in interpreting the various codes if one should appear on the screen.

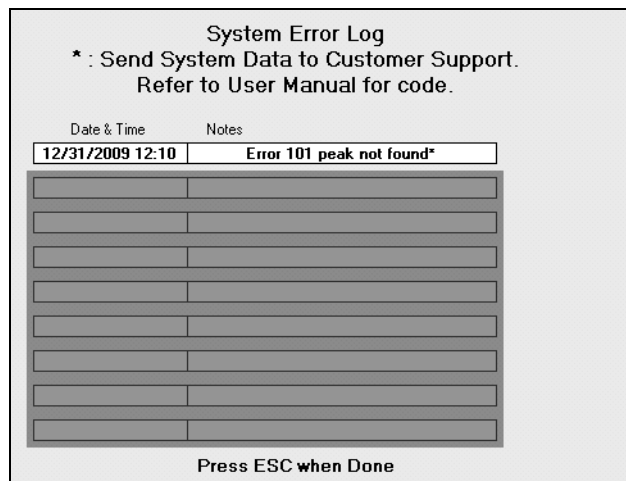

Figure 42: System Error Code Screen

### 7.4.6.3 Pump Capacity Test Log

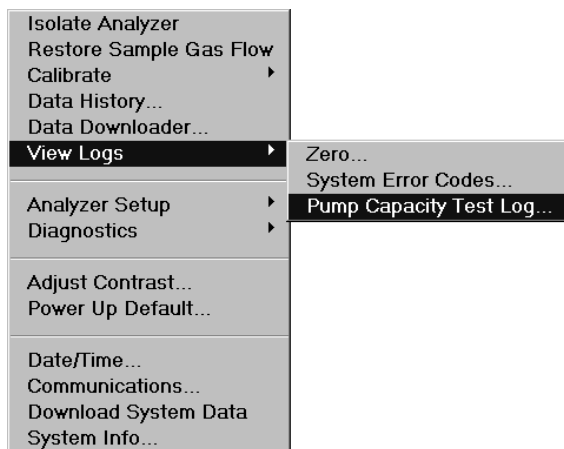

Figure 43: Pump Capacity Test Log Menu

The pump capacity test is used to determine the condition of the aspirator or vacuum pump which in turn will have a direct impact the flow of gas through the analyzer. A reduction in pump capacity can result in a reduction in gas flow and as a result on the stability of the analyzer reading. See page **Error! Bookmark not defined.** for additional information on the pump capacity test. As the last step of the test, the system automatically puts an entry in the pump capacity test log for future reference. See Figure 43. Review of this information can be useful in detecting a trend in the condition of the aspirator or pump which can result in a need to rebuild the pump.

Date & Time	Notes	h2o	torr
12/23/2009 16:05	pump capacity test	13.3	198.00
12/23/2009 16:05	pump capacity test	13.3	113.00
12/23/2009 16:04	pump capacity test	13.3	119.00
10/22/2009 14:26	pump capacity test	6.3	111.00
10/22/2009 14:26	pump capacity test	6.3	111.00
10/22/2009 14:26	pump capacity test	6.3	111.00
10/22/2009 14:24	pump capacity test	5.8	111.00
10/22/2009 14:23	pump capacity test	5.7	111.00
10/06/2009 15:02	pump capacity test	3.9	92.00

↓more      Press ESC when Done

Figure 44: Pump Capacity Test Log

## 7.4.7 Analyzer Setup

The analyzer setup menu allows the user access to the Gas Scale Factor settings, Alarm Setups, Analog Output setup and Graph setup.

Use the arrow keys (▲ and ▼) to scroll up and down through the list. Pressing ESC will return to the main display.

### 7.4.7.1 Sample GSF

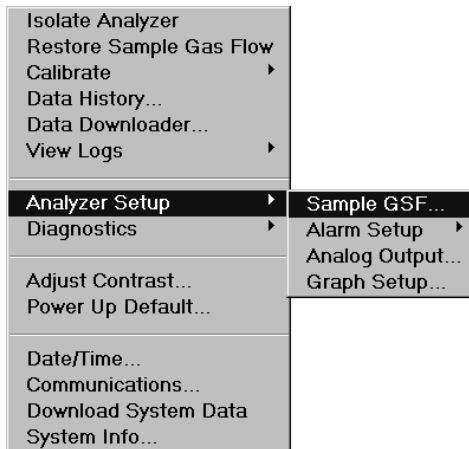

Figure 45: Sample GSF Menu

The GSF setup (Gas Scale Factor) is critical for obtaining quantitatively correct results. It accounts for the fact that moisture molecules have different absorption features in different buffer gases.

The GSF should be applied when the user has any knowledge of a change in the buffer gas or change in the percentages of a mixed background gas. The default setting from the factory is 100% N<sub>2</sub>, yielding a GSF of 1.00.

Use the **Next** key to move from between fields and use the arrow keys (▲ and ▼) to change the highlighted selections and to enter numerical values. When done, use the **Next** key to move to the **Accept** button and hit the **Enter** key to return to the main display. Using the **ESC** at anytime will exit the screen making no changes and return to the main display.

After the percentages of all background gas are entered, the **Accept** button is hit and the system confirms that the total is 100%. Next if appropriate, the system indicates the proper pressure setting as in Figure 47 and the limits are set on the Pressure Alarm Screen.

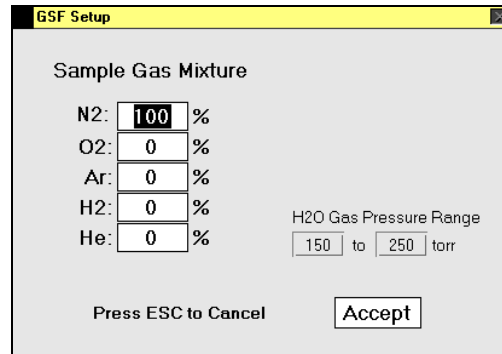

Figure 46: Sample GSF Setup Screen

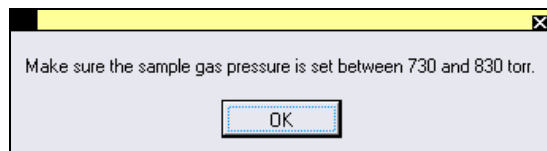

Figure 47: GSF Pressure Setting

NOTE: An entry of any percentage of Hydrogen in the GSF calculation will automatically engage the Hydrogen Safety Service System option if equipped. See page 89 for additional information.

#### 7.4.7.2 Fan Failure

The analyzer constantly monitors the condition of the cabinet exhaust fans. If a problem is detected a system error #191 "Fan Failure" is reported over the moisture display.

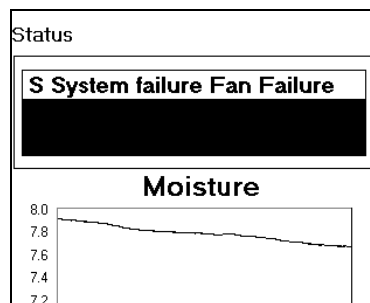

Figure 48: Fan Failure Alarm

In addition, if hydrogen is entered as a gas in the GSF Setup, and the system detects a failure in the exhaust fan circuitry the entire analyzer will automatically isolate. A message of “Fan Failure” as shown in Figure 48 will flash over the moisture reading on the main display and the user will be unable to restore any flow until the fan problem has been fixed.

### 7.4.7.3 Alarm Setup

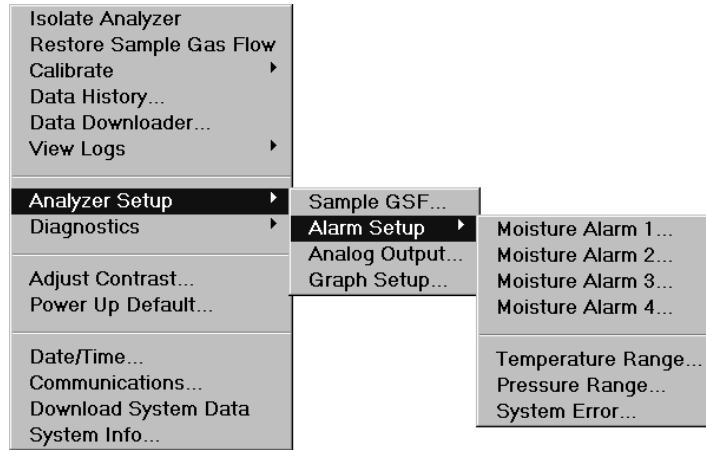

Figure 49: Alarm Setup Menu

The moisture analyzer includes a total of seven alarms. The four moisture concentration alarms can be user controlled to activate up to four optional relays. High and low setpoints as well as deadbands are user-set.

Alarm Number	Function
1	Moisture Level 1
2	Moisture Level 2
3	Moisture Level 3
4	Moisture Level 4
P	Pressure
T	Temperature
S	System

Table 6: Alarm Codes

The temperature alarm indicates an out of specification ambient temperature condition in the analyzer cabinet.

The pressure range alarm is related to the pressure in the gas path.

Finally, system errors are monitored, and under certain conditions will trip alarms if enabled.

An alarm warning will overwrite the moisture level readout if an alarm condition exists. To acknowledge the alarm simply hit the **Enter** button and its number or letter will appear in the Alarm Status line above the display. See Figure 18. This action will not clear the alarm. Only restoration of the condition that existed prior to the alarm will clear the alarm. Following is a list of alarm code abbreviations that can appear in the Status Line:

NOTE: When any hydrogen is included in the background gas matrix (see discussion regarding GSF on page 49 for additional information), an additional alarm is enabled to monitor the cabinet exhaust fan status. If the system detects a failure in the operation of the cabinet exhaust fans while operating in a hydrogen background, the system immediately isolates the moisture cell until the fan is repaired. A warning describing this condition will appear over the main display and the user will be unable to restore gas flow until the fan is repaired. See Fan Failure on page 50.

#### 7.4.7.4 Moisture Alarm Setup

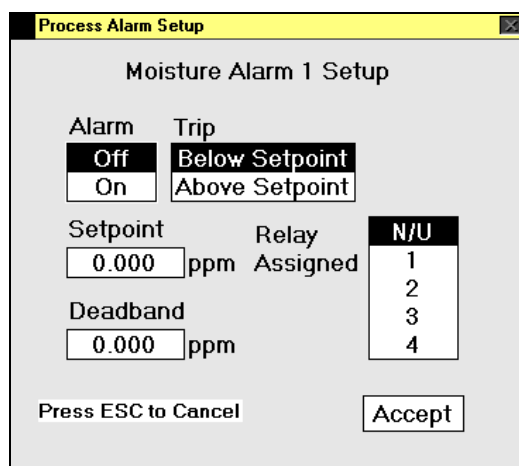

Figure 50: Alarm Setup Screen

The Setpoint value refers to the limit above or below which the alarm is triggered. The Trip command sets the above/below parameter. The deadband refers to the value from the nominal setpoint that the output value must exceed before an alarm is reset. The Relay Assignment indicates to which relay the alarm is assigned.

Use the **Next** key to move from between fields and use the arrow keys (▲ and ▼) to change the highlighted selections and to enter numerical values. When done, use the **Next** key to move to the **Accept** button and hit the **Enter** key to return to the main display. Using the **ESC** key at anytime will exit the screen making no changes and return to the main display.



### 7.4.7.5 Temperature Range Alarm Setup

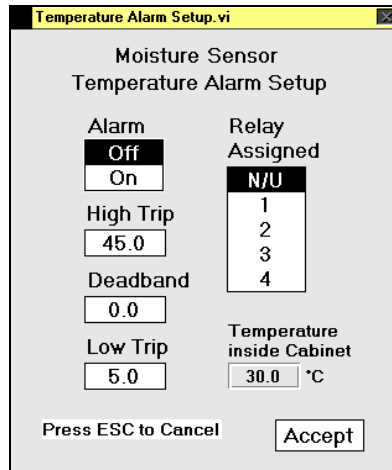

Figure 51: Temperature Alarm Setup

The system is constantly monitoring the ambient temperature in the analyzer cabinet. If enabled on the Temperature Alarm Setup screen, an alarm can be assigned to trip if the ambient temperature exceeds preset limits. The user may assign the temperature alarm to one of four relays.

Use the **Next** key to move from between fields and use the arrow keys (**▲** and **▼**) to change the highlighted selections and to enter numerical values. When done, use the **Next** key to move to the **Accept** button and hit the **Enter** key to return to the main display. Using the **ESC** key at anytime will exit the screen making no changes and return to the main display.

### 7.4.7.6 Pressure Alarm Setup

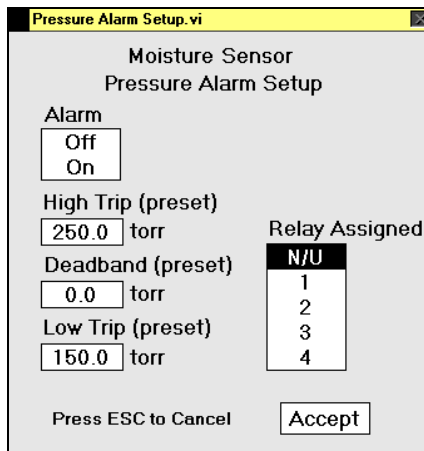

Figure 52: Pressure Alarm Setup

The system is constantly monitoring the pressure in the gas path and the result is displayed on the front panel. If enabled on the Pressure Alarm Setup screen, an alarm can be assigned

to trip if the pressure exceeds preset limits. The user may assign the pressure alarm to one of four relays.

The limits are not user adjustable but are set automatically on the basis of the background gases entered in the GSF screen. See page 49 for additional information on setting the background gases.

Use the **Next** key to move from between fields and use the arrow keys (▲ and ▼) to change the highlighted selections and to enter numerical values. When done, use the **Next** key to move to the **Accept** button and hit the **Enter** key to return to the main display. Using the **ESC** key at anytime will exit the screen making no changes and return to the main display.

#### 7.4.7.7 System Alarm Setup

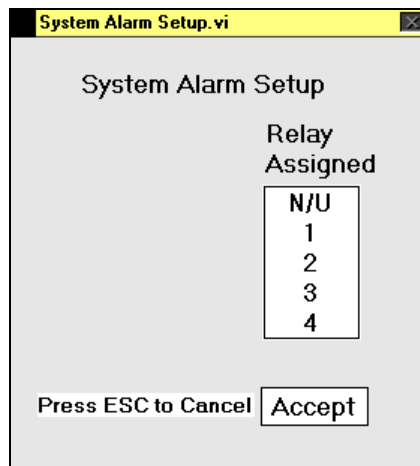

Figure 53: System Alarm Setup

If left for more than 30 minutes, a System Error Code will trip a System Alarm if configured to do so. See page 47 for additional information on System Error Codes.

NOTE: The 30 minute clock is delayed for 60 minutes on a “cold” system start up.

Use the **Next** key to move from between fields and use the arrow keys (▲ and ▼) to change the highlighted selections and to enter numerical values. When done, use the **Next** key to move to the **Accept** button and hit the **Enter** key to return to the main display. Using the **ESC** key at anytime will exit the screen making no changes and return to the main display.

## 7.4.8 Analog Output Setup

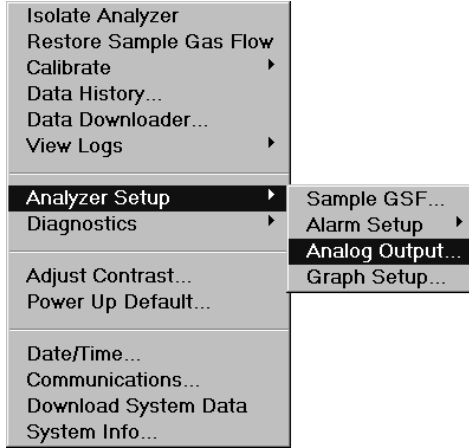

Figure 54: Analog Output Setup Menu

The Zero Point corresponds to the lowest voltage or current output (0 VDC, 4 mA) that is sent to a recorder, while the Full Scale corresponds to the maximum voltage or current output (1/5/10 VDC or 20mA) that is sent. The Full Scale set point (FS) is set from 0.002 ppm to 20.00 ppm.

Three ranges can be entered in this screen. The range of the primary Full Scale (FS) must be less than that of the Expanded Full Scale “A” (FS A) which must be less than that of the Expanded Full Scale “B” (FS B). The analyzer auto-ranges between the three outputs depending on the current analyzer reading. Relay contacts can then be assigned to signal a change in range. If only one expanded range is required, rather than two, then the value of FS B should be set to equal the FS A value.

A window as narrow as 10% of the analyzer’s decades can be set for the full-scale analog output.

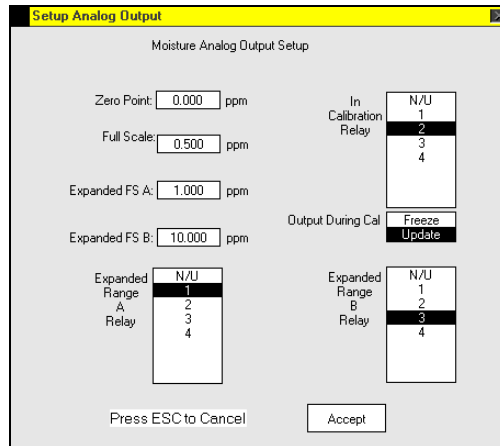

Figure 55: Analog Output Setup Screen

The In Calibration Relay can be enabled to signal that a zero calibration is in process. In addition, the user has the option to freeze the analog output or enable the analog output to update as the calibration progresses.

## 7.4.9 Graph Setup

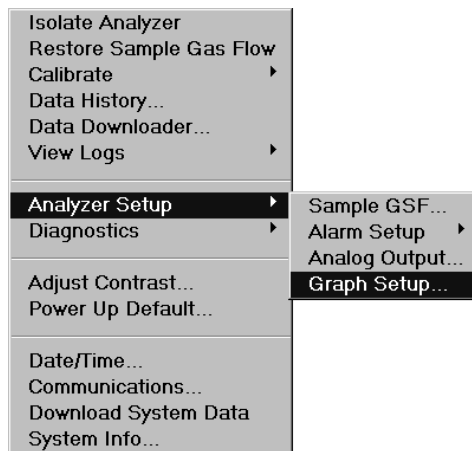

Figure 56: Graph Setup Menu

The graph setup is used to adjust the time scale on the main data display of the analyzer. A specific time interval in minutes can be chosen for the X-axis on that display. The minimum acceptable time is 3 minutes. The information on the display represents current data and will show a history of moisture concentration based on the given time span to the present. The Y-axis of the main data display is auto-ranging.

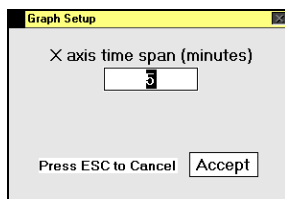

Figure 57: Graph Setup Screen

## 7.4.10 Diagnostics Menu

The Diagnostics menu gives the user access to control the Active Zero function, to test the Relays and Analog Outputs, and to check the Signal Monitor.

Use the arrow keys (▲ and ▼) to scroll up and down through the list. Pressing ESC will return to the main display.

### 7.4.10.1 Active Zero On/Off

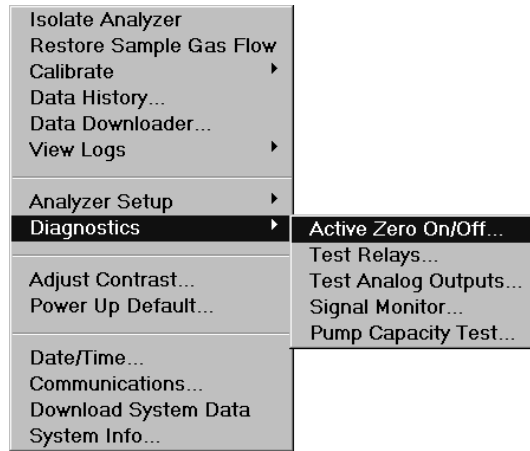

Figure 58: Active Zero On/Off Menu

The Active Zero Offset feature is designed to automatically compensate for the analyzer's gradual zero baseline cleanup. This gradual cleanup is natural and occurs after a fresh startup or after a prolonged or abnormally high moisture exposure. This feature ensures that accurate low ppb H<sub>2</sub>O readings can be made as soon as possible after initial startup, or after a high H<sub>2</sub>O upset event. It is similar to the User Zero Offset feature in that a small positive offset is added to the analyzer H<sub>2</sub>O readings (display and output) to compensate for the long term downward trending in the readings during cleanup. The Active Zero Offset provides an automatic addition of offset that occurs in miniscule steps, and within set guidelines, corresponding to predictable behavior during cleanup.

When Active Zero Offset is enabled through the Diagnostics Menu, the User Zero Offset feature is disabled and vice versa. See page 40 for more information on the User Zero function. While the User Zero Offset feature requires the user to enter a fixed positive offset value to accommodate the baseline cleanup, the Active Zero Offset does so automatically, and only when necessary.

The current Active Zero Offset value is shown in the Check/Adjust Zero screen as shown in Figure 27. It starts at a value of 0.00 ppb when the analyzer is first turned on, and then increments automatically as the analyzer applies offset to the readings. After each User Zero Calibration, the Active Zero Offset value is reset to 0.00 ppb and then automatically increments again as needed.

The Active Zero Offset is designed to operate when the zero baseline is falling at a rate less than 0.1 ppb/hr as would be the case after 1-2 weeks of initial operation. If user calibrations are performed sooner, the H<sub>2</sub>O readings may be decreasing too rapidly for the Active Zero Offset feature to operate properly and negative H<sub>2</sub>O readings may result.

If the Active Zero Offset value reaches 5 ppb a warning message CAL ZERO will flash in the system status block on the display instructing the user that a zero calibration should be performed. The maximum amount of offset that can be applied by this feature is 5 ppb. Any further downward trend (baseline cleanup) exceeding -0.3ppb will result in negative readings until the next user calibration is performed resetting the Active Zero Offset value to zero.

If the Active Zero Offset feature is turned off, the User Zero Offset value will appear in its' place in the Check/Adjust Zero menu. The previous user Zero Offset value (if any) will reappear and immediately be applied to the live display readings. Likewise, if the Active Zero Offset feature is on, then its' value (if any) will appear and immediately be applied to the live readings.

#### 7.4.10.2 Test Relays

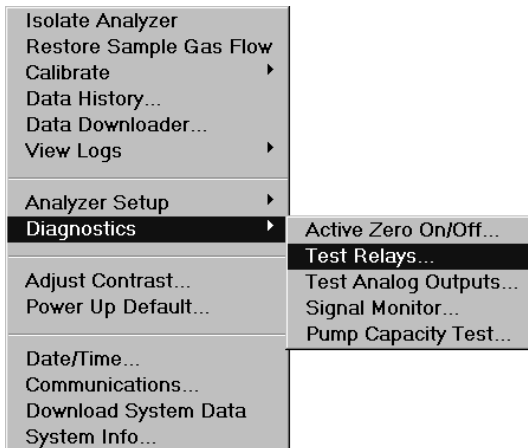

Figure 59: Test Relays Menu

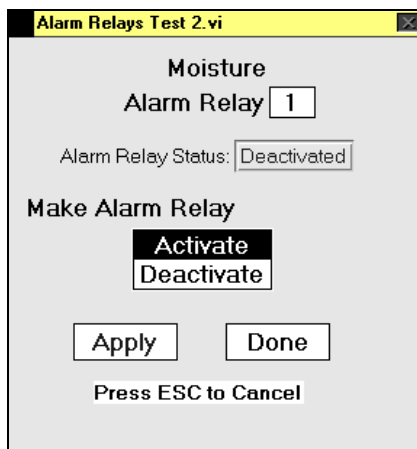

Figure 60: Test Alarm Relays Screen

The Test Relays screen, as shown in Figure 60, is used to assure that the relay outputs are functioning properly. When the Test Relays screen is selected, the NEXT key is used to move to the number field where the arrow keys (▲ and ▼) are used to choose the appropriate relay number. The NEXT key is then used to move to the Activate/Deactivate field where the arrow keys (▲ and ▼) are used to toggle between the two options. The NEXT key is then used to move to the Apply field where the Enter key is hit to change the relay state. This process can be repeated as often as needed. When done, the NEXT key is used to move to the Done field and the Enter key is hit to leave the screen. The condition of the relays before the test is restored when the test is concluded. See the section on relay ports found on page 33 for additional information.

### 7.4.10.3 Test Analog Voltage Output

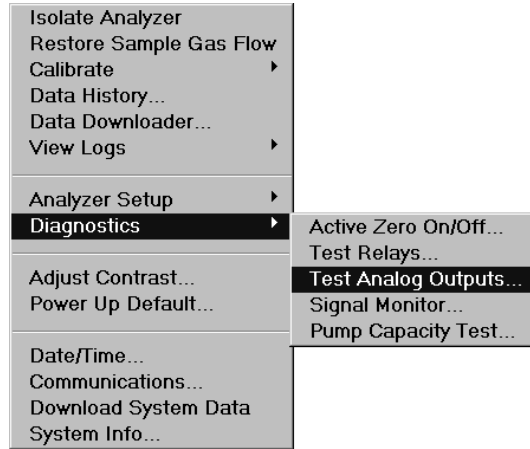

Figure 61: Test Analog Outputs Menu

The Test Output screen, as shown in Figure 62, is used to calibrate the analog recorder output. When the Test Output screen is selected, the NEXT key is used to move to the percentage field where the arrow keys (▲ and ▼) are used to choose the appropriate setting. The NEXT key is then used to move to the Apply field where the Enter key is hit to set the analog output to the selected value. The analog output response should match the value that was entered. For example, if 80 percent is entered for the percent full scale level, and the analog output is set for 0 to 10 VDC, the analog output is 8.000 VDC. This process can be repeated as often as needed. When done, the NEXT key is used to move to the Done field and the Enter key is hit to leave the screen. The condition of the analog output before the test is restored when the test is concluded. See the section on analog outputs found on page 32 for additional information.

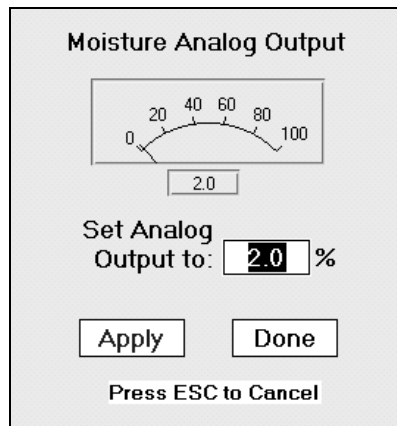

Figure 62: Test Analog Voltage Output Screen

#### 7.4.10.4 Signal Monitor

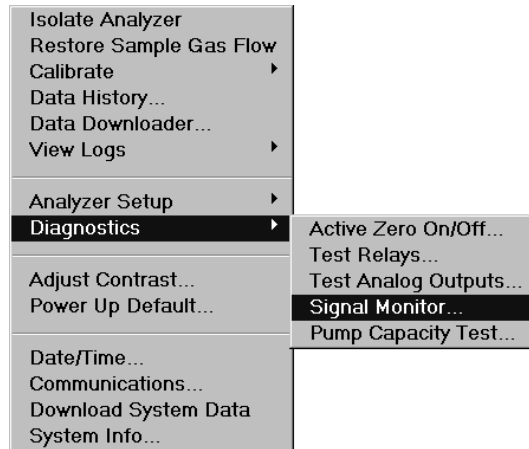

Figure 63: Signal Monitor Menu

The Signal Monitor depicts 18 system parameters in numerical order. Each parameter is unique for each system. In the event of a system error, these parameters can be used as a diagnostic tool. See page 47 for additional information on system errors.

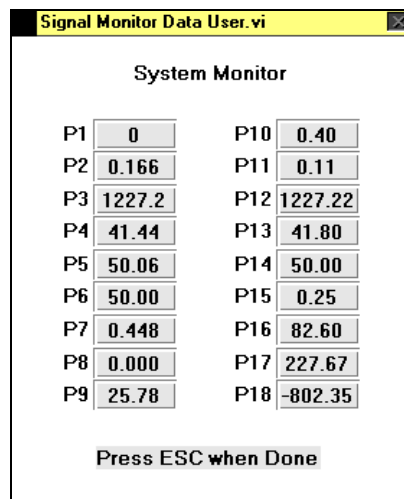

Figure 64: Signal Monitor Screen

#### 7.4.10.5 Pump Capacity Test

The pump capacity test can be used to determine the ultimate vacuum that the aspirator or pump is capable of pulling and as a result its' capacity to pull sufficient sample through the analyzer. The test is automatic in nature, in that once started, the analyzer isolates the moisture cell by closing the upstream and downstream valves and then the vacuum is monitored for 20 seconds and is displayed on the screen. Any pressure lower than 115 Torr is considered acceptable. If the aspirator or pump is unable to pull 115 Torr, a failure is indicated by the appearance of Figure 67 and the recommendation to rebuild the pump or check for leaks. At the end of the 20 second test, whether the aspirator or pump passes or fails, the user must hit Escape to return to the main display.



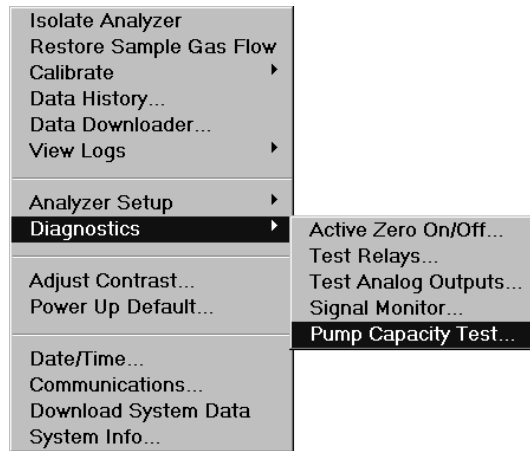

Figure 65: Pump Capacity Test Menu

After the pump test is complete, an entry is automatically put in the pump capacity test log as shown in Figure 68. See page 48 for additional information on the pump test log.

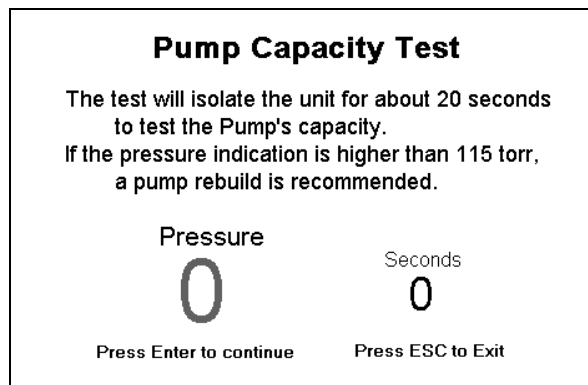

Figure 66: Pump Capacity Test Screen

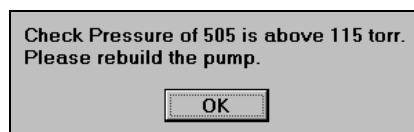

Figure 67: Pump Pressure Failure

Date & Time	Notes	h2o	Torr
12/23/2009 16:05	pump capacity test	13.3	198.00
12/23/2009 16:05	pump capacity test	13.3	113.00
12/23/2009 16:04	pump capacity test	13.3	119.00
10/22/2009 14:26	pump capacity test	6.3	111.00
10/22/2009 14:26	pump capacity test	6.3	111.00
10/22/2009 14:26	pump capacity test	6.3	111.00
10/22/2009 14:24	pump capacity test	5.8	111.00
10/22/2009 14:23	pump capacity test	5.7	111.00
10/06/2009 15:02	pump capacity test	3.9	92.00

↓more      Press ESC when Done

Figure 68: Pump Capacity Test Log

## 7.4.11 Adjust Contrast



Figure 69: Adjust Contrast Menu

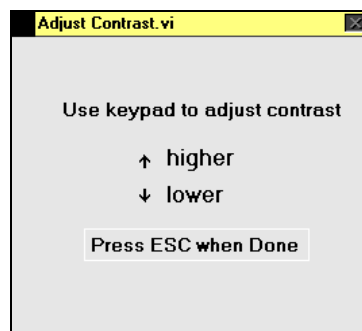

Figure 70: Adjust Display Contrast Screen

This screen allows the user to modify the contrast of the front display screen. From the System menu, select Adjust Contrast. Use the up and down arrows (▲ and ▼) as indicated to make adjustments. Hit ESC on the key pad when done.

## 7.4.12 Power Up Default – Optional

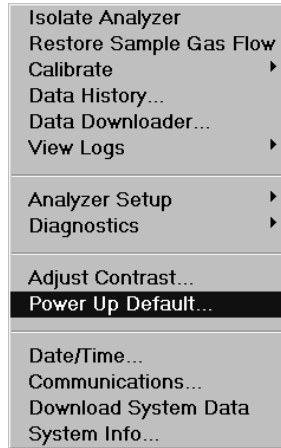

Figure 71: Power Up Default Menu

This menu item is only available on analyzers equipped with the isolation valve option.

The Power Up Default SubRoutine allows the user to determine the various default states during analyzer power up. The power up states are useful because they determine whether, for instance, the sensor is protected from ambient air contamination or whether it is configured the best way for rapid station to station transfer and measurement.

Use the NEXT key to move from field to field. Use the up and down arrows (▲ and ▼) to move between the selections within the field. When done use the NEXT key to move to the Accept field and hit the Enter key. Pressing the ESC at any time will make no changes and will return to the main data display.

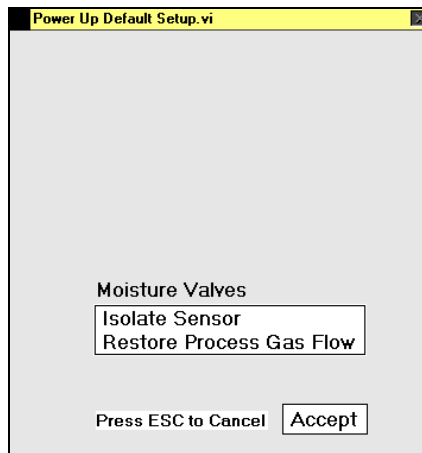

Figure 72: Power Up Default Screen

NOTE: If the analyzer auto-reboots due to a system error 20006, the power-up defaults (if applicable) are ignored and the analyzer returns to the mode of operation found immediately before the error. This reboot action is identified in the system error log as an error 222. See page 47 for additional information on system error codes.

## 7.4.13 Date/Time



Figure 73: Date/Time Menu

The Date/Time Screen is used to set various calendar and clock related parameters.

The **Next** key is used to moved from field to field, and the arrow keys (▲ and ▼) are used to change the numerical digits and units.

When in the Time Zone field the left and right arrow keys toggle through the various options. When done the **Next** key is used to move to the **Accept** field and the **Enter** key is hit.

Hitting the **Esc** key at any time will exit the screen with no changes and return the user to the main data display.

NOTE: The time is not automatically adjusted for daylight savings and must be changed manually.

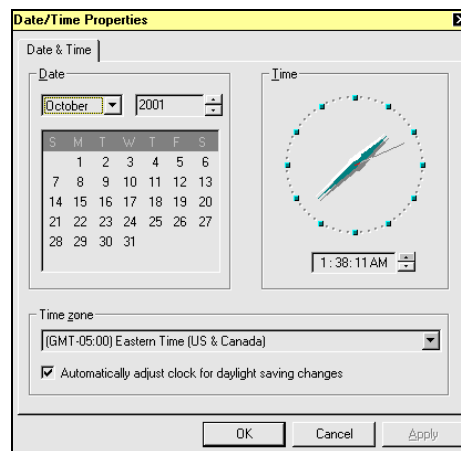

Figure 74: Date/Time Setup Screen

## 7.4.14 Communications

The Communications screen is used to set parameters related to serial PC communications. Accessed from the **System** menu, the **Next** key is used to move from field to field, and the arrow keys (▲ and ▼) are used to change the numerical digits as well as to select the baud rate. When done the **Next** key is used to move to the **Accept** field and the **Enter** key is hit. See page 31 for additional information.



Figure 75: Communications Menu

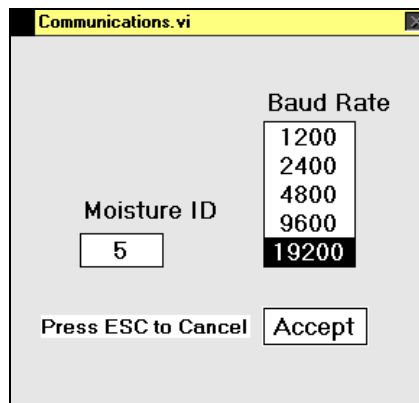

Figure 76: Communications Setup Screen

## 7.4.15 Download System Data

In the event that problems develop with the analyzer, the contents of the internal system data files can easily be downloaded to a USB memory stick, and the files can either be mailed or e-mailed to Delta F for evaluation. Install a memory stick into the external USB socket located behind the front door and on the left side of the analyzer. After hitting **Enter** from the **Download System Data** menu, Figure 78 will appear.

The system automatically selects the current date. To change the date, use the **Next** key to move between fields and use the arrow keys (▲ and ▼).

Hit **Enter** and the download process will begin and a time bar will appear as in Figure 80. The process should only take a minute or two and when complete control will be returned to the user.



Figure 77: Download System Data Menu

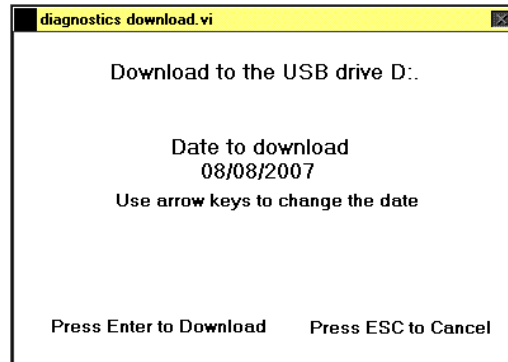

Figure 78: Insert Media

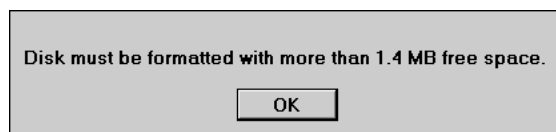

Figure 79: Media Warning

If there is insufficient space available on the media a warning will appear as in Figure 79.

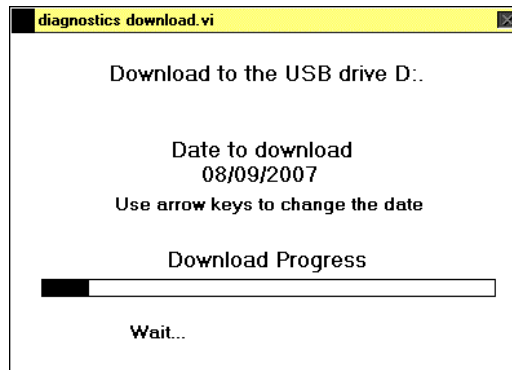

Figure 80: Download Time Line

The file name is automatically created and includes the date and time that the data was recorded as well as the serial number of the analyzer. All files are then automatically compressed and loaded as one file on the memory stick, which then can be used to forward the information to Delta F for evaluation.

## 7.4.16 System Info



Figure 81: System Info Menu

The System Info screen gives the user information regarding the configuration of the analyzer as well as the version of firmware currently installed. The Service Menu is password protected. Contact the factory regarding this function.

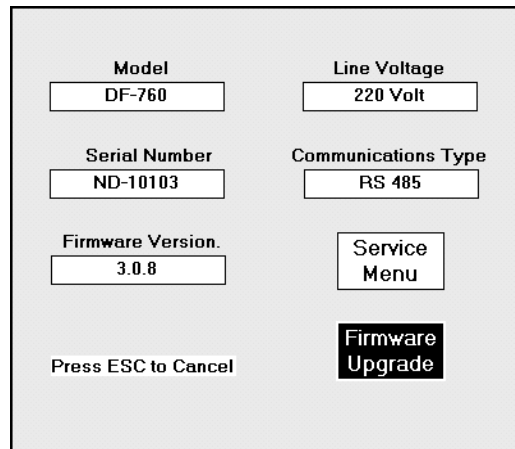

Figure 82: System Info Screen

#### 7.4.16.1 Firmware Upgrade

While the Firmware Upgrade box is highlighted, hitting the Next key will bring up the Firmware Upgrade dialog box as in Figure 83 below.

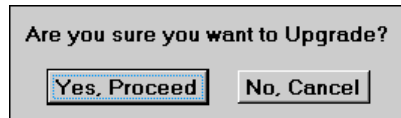

Figure 83: Software Upgrade Screen

Place the USB memory stick in the external USB socket located behind the front door, When ready hit the **Yes, Proceed** key and follow the instructions. At the conclusion of the upgrade the analyzer will automatically reboot.



# 8 Sample Gas Preparation and Delivery

## 8.1 Introduction

It is important to note key differences in each parameter to ensure a properly functioning system. Parameters such as flow, pressure, and background gas will have major effects on total system performance.

## 8.2 Sample Flow Rate and Pressure

Proper moisture analyzer operation is dependant upon the pressure of the sample gas. For each sample gas, there is a unique pressure range that the analyzer must operate under. See Table 7 for the proper settings. Proper analyzer operation is contingent upon maintaining the sample pressure for a given background gas within this range. The pressure can be adjusted by balancing the inlet regulator setting with the throttling valve in the aspirator or, if equipped, with the needle valve in the vacuum pump assembly.

Background Gas	Pressure
N2	200 +/- 20 Torr
Ar	330 +/- 20 Torr
He	780 +/- 20 Torr
H2	350 +/- 20 Torr
O2	350 +/- 20 Torr

Table 7: Sample Outlet Pressure

## 8.3 Flow Rate Effects on Sensor Performance

Assuming a leak-free system, flow rate changes will have minimal effects on the performance of the moisture cell.

## 8.4 Sample Gas Scale Factor

### 8.4.1 Background Gas Effects on Indicated Flow Rate

If the molecular weight of the background gas is much different from N<sub>2</sub>, the flowmeter reading is not accurate. The bypass loop flowmeter mounted on the rear of the DF-700 series Moisture Analyzer is calibrated for use in air (or N<sub>2</sub>). Most other gases have molecular weights within  $\pm 25$  percent of air. Since the required flow rate is not extremely critical most gases produces reasonably correct readings. The exceptions are light gases

such as Helium and Hydrogen whose flow rates should be set to approximately one-third that of Nitrogen.

## **8.5 Flammable Sample Gas**

There is nothing within the analyzer sample system that can ignite a flammable sample gas. However, it is critical to ensure that the sample gas does not escape from the sample system into the analyzer enclosure, or the room, where ignition is possible.

Also, the analyzer enclosure can be purged with nitrogen, or the entire Analyzer can be mounted in a purged enclosure, so that any sample gas that escapes the plumbing is diluted.

# 9 Service

## 9.1 Return Material Authorization number

If an analyzer has to be returned to the factory, the shipper will have to obtain a Return Material Authorization number from Delta F by calling the Service Line at (781) 935-5808 or sending a written request via their Service Fax Line at (781) 932-0053. See the *Shipping* section for more details.

## 9.2 Maintenance

### 9.2.1 Storage Conditions

If the analyzer is to be stored for extended periods of time, be sure that the temperature of storage location does not exceed 50° C (122° F). Storage in direct sunlight can cause temperatures to exceed the recommended limits even though ambient temperatures may be below the maximum temperature.

Store the analyzer with the electrolyte removed from the sensor.

### 9.2.2 Moisture Cell Maintenance

None required.

### 9.2.3 Vacuum Pump Maintenance

The vacuum pump, if equipped, requires periodic maintenance in order to maintain proper pressure and individual installations will ultimately determine the appropriate maintenance interval. A good working pump will pull down to 120 torr or less, but when pump performance degrades to the point that proper pressure cannot be attained, a significant improvement in performance can often be achieved by simple cleaning of the cylinder and piston assembly. A rebuild kit is available from Delta F to return the pump to original specifications. See the list on page 73 for cleaning fluid and rebuild kit part numbers.

#### 9.2.3.1 Cleaning Vacuum Pump Piston and Cylinder Assembly

1. Disconnect power and vent all lines
2. Remove head bolts, head, gasket and valve plate assembly (note orientation of head)
3. Remove cylinder and shims.
4. Clean residue from walls using a soft cloth and non-petroleum, non-oil based solvent.
5. Replace cylinder including all shims. Be sure to orient the shims exactly the same as they were removed.

6. Install valve plate, head gasket and head
7. Install head bolts and torque to 80 in-lbs.

## 9.3 Replaceable Parts List

When ordering parts, please be certain to supply the model number and serial number of your analyzer.

PART NO.	PART DESCRIPTION
	<b><u>Printed Circuit Boards</u></b>
10424570	Moisture Board
54000001	Front Display
	<b><u>Hardware Items</u></b>
14241410	Aspirator
63000308	Vacuum Pump – 110 VAC
63000309	Vacuum Pump – 240VAC
63000004	Vacuum Pump Rebuild Kit
76000018	Vacuum Pump Cleaning Fluid
65000100	Vacuum control needle valve
	Gas Panel Ass'y with heater
60300241	VCR Gasket
60300268	VCR Filter Gasket
45002363	Fuse 6.3 Amps (110VAC)
45002331	Fuse 3.15 Amps (220VAC)
59017237	Power Cord – 110 VAC
10425870	Linear Power Supply
47500000	Switching Power Supply
49600512	USB Memory Stick/Flash Drive
58000001	Floppy Disc Drive

Table 8: Replaceable Parts List



## 9.4 Troubleshooting the DF-745 NanoTrace Analyzer

The DF-700 series moisture analyzer constantly performs internal monitoring of the analyzer operation. In the event of a failure a system alarm will be displayed on the front panel. In addition the failure will be logged in the System Error Log (see page 47). In the event of a system alarm contact Delta F with information as displayed in the log as well as on the Signal Monitor screen as shown on page 60.

### Shipping

If it is necessary to return the analyzer to the factory or ship it to another location, follow the packaging and shipping procedure below in order to prevent damage to the analyzer during shipment.

1. Isolate the analyzer gas path properly by following the steps on page 37.
2. Turn off the power switch. Disconnect any source of AC power from the analyzer.
3. Disconnect all external electrical connections (alarms, data output, communications etc.).
4. Mark each for reattachment later.
5. Ensure that all internal components are adequately secured and put the analyzer in its original container.

If the analyzer is being returned to the factory, call Delta F at (781) 935-5808 to obtain a **Return Material Authorization number**. Clearly mark the Return Material Authorization number on the outside of the shipping container and on the packing list.

The analyzer should be returned (freight prepaid) to:

Delta F Corporation  
4 Constitution Way  
Woburn, MA 01801-1087





# 10 Theory of Operation

## 10.1 The Moisture Measurement

### 10.1.1 Moisture and the IR Spectrum

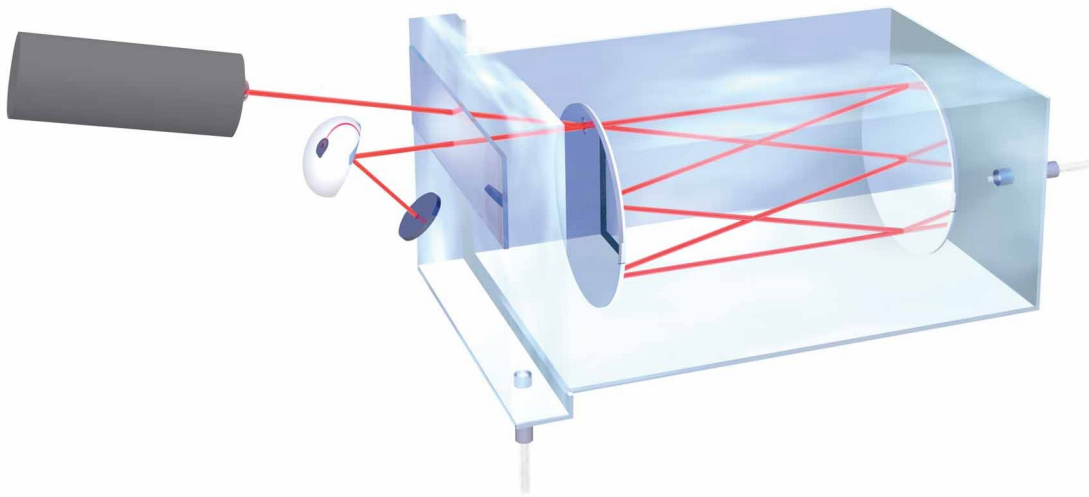

Figure 84: Schematic of Moisture Cell

The Nanotrace Moisture analyzer uses infrared (IR) absorption as its detection method. IR absorption is but a subset of the overall field of “spectroscopy,” which measures the interaction of light and matter.

The basis of absorption spectroscopy is when an electromagnetic wave (i.e., the scientific description of “light”) with a particular wavelength impinges on a substance that absorbs a fraction of the total electromagnetic radiation. The wavelength of radiation is well known, for instance, in differentiating colors in the visible light spectrum.

In the infrared spectral region, the wavelength of light overlaps with discrete absorptions created by molecular vibrations. IR absorption is often used in diagnosing molecular composition based on “fingerprints” of these absorptions over a wide wavelength range. Conversely, if the strength of a single vibrational absorbance is known, a single wavelength is often used to determine the amount of a particular substance. This is how we measure moisture.

## 10.1.2 Absorption Spectroscopy

The relationship that defines absorption spectroscopy is known as Beer's Law. Beer's Law equates, in rigorous terms, the concentration of any absorbing molecule based on absorbed light intensity at a particular wavelength, given knowledge of the molecule's absorption strength and the "path length" of the sample medium.

Many are familiar with Beer's Law as it is conventionally used in analytical laboratories:

$$A_{\lambda} = \log(1/T)_{\lambda} = \log(I_0 / I)_{\lambda} = 2.303 \times \epsilon_{\lambda} \times b \times C$$

$A_{\lambda}$   $\equiv$  Absorbance at wavelength  $\lambda$

$T$   $\equiv$  Transmittance

$I_0$   $\equiv$  Reference Intensity of Light

$I$   $\equiv$  Measured Intensity of Light after Absorption

$\epsilon_{\lambda}$   $\equiv$  Molar Absorptivity at wavelength  $\lambda$

$b$   $\equiv$  Path length

$C$   $\equiv$  Molar concentration

In this embodiment, a solution with a broad absorbance band is dialed to a wavelength within the band, where a substance's molar absorptivity is known, and the concentration of that substance is determined. The substance is usually a liquid solution, placed in a 1 cm cuvette, and the concentration is expressed in moles/liter.

This same Law can have units reassigned to determine absolute numbers of molecules per cubic centimeter, useful in gaseous measurements:

$$A_{\lambda} = \ln(I_0 / I)_{\lambda} = \sigma_{\lambda} \times b \times N$$

$\sigma_{\lambda}$   $\equiv$  Molecular Cross Section ( $\text{cm}^2/\text{molecule}$ ) at wavelength  $\lambda$

$N$   $\equiv$  Molecular Density ( $\text{molecules}/\text{cm}^3$ )

The values  $\sigma$  and  $\epsilon$  are related primarily by Avogadro's Number. If the molecular density of an absorbing substance in gas, such as moisture, is known, it can be compared to the number of molecules in an ideal gas, resulting in a report of parts per billion (PPB). In gases, this concentration is also known more specifically as parts per billion in volume (PPB<sub>v</sub>).

# 11 Safety

## 11.1 General Warnings

### DANGER



*Potentially hazardous AC voltages are present within this instrument. Leave all servicing to qualified personnel. Disconnect the AC power source when installing or removing: external connections, the sensor, the electronics, or when charging or draining electrolyte.*

### CAUTION



*Do not setup or operate the Analyzer without a complete understanding of the instructions in this manual. Do not connect this Analyzer to a power source until all signal and plumbing connections are made.*

### CAUTION



*This analyzer must be operated in a manner consistent with its intended use and as specified in this manual.*

### EMI DISCLAIMER



*This Analyzer generates and uses small amounts of radio frequency energy. There is no guarantee that interference to radio or television signals will not occur in a particular installation. If interference is experienced, turn-off the analyzer. If the interference disappears, try one or more of the following methods to correct the problem:*

- Reorient the receiving antenna.
- Move the instrument with respect to the receiver.
- Place the analyzer and receiver on different AC circuits.



# 12 Warranty

Delta F Corporation warrants each instrument manufactured by them to be free from defects in material and workmanship at the F.O.B. point specified in the order, its liability under this warranty being limited to repairing or replacing, at the Seller's option, items which are returned to it prepaid within one year from delivery to the carrier and found, to the Seller's satisfaction, to have been so defective.

In no event shall the Seller be liable for consequential damages. NO PRODUCT IS WARRANTED AS BEING FIT FOR A PARTICULAR PURPOSE AND THERE IS NO WARRANTY OF MERCHANTABILITY. Additionally, this warranty applies only if: (i) the items are used solely under the operating conditions and in the manner recommended in the Seller's instruction manual, specifications, or other literature; (ii) the items have not been misused or abused in any manner or repairs attempted thereon; (iii) written notice of the failure within the warranty period is forwarded to the Seller and the directions received for properly identifying items returned under warranty are followed; and (iv) with return, notice authorizes the Seller to examine and disassemble returned products to the extent the Seller deems necessary to ascertain the cause of failure. The warranties stated herein are exclusive. THERE ARE NO OTHER WARRANTIES, EITHER EXPRESSED OR IMPLIED, BEYOND THOSE SET FORTH HEREIN, and the Seller does not assume any other obligation or liability in connection with the sale or use of said products.



# 13 Index

## 4

4-20mA Outputs, 32

## A

Active Zero On/Off, 57  
Add Location, 45  
Adjust Contrast, 62  
Alarm Setup, 51  
Alarm Setup, Moisture, 52  
Analog Output Setup, 55  
Analog Signal Outputs, 32  
Analog Voltage Output, 25  
Analog Voltage Output Test, 59  
Analyzer  
    Specifications  
        General, 9  
        Moisture, 9  
    Warranty, 81  
Analyzer Setup, 49  
Analyzer Shut Down, 21  
Analyzer Start Up, 19

## C

Calibrate, 38  
case purge, 89  
Cautions, 7  
    Important Warnings, 7  
    Symbols and Explanations, 7  
Check/Adjust Zero, 39  
Check/Adjust Zero, Moisture, 40  
Communications, 65

## D

Data Downloader Routine, 44  
Date/Time, 64  
Delete Location, 46  
Diagnostics Menu, 56  
Display Setup, Moisture, 56  
Download System Data, 65

## E

Electrical Connections, 17  
Error Codes, 47  
External Devices, Connecting to  
    4-20mA Outputs, 32

Analog Signal Outputs, 32  
Relay Ports, 33  
Serial Communications, 31  
External Devices, Connecting to, 31

## F

Fan Failure, 50  
Fan Failure Alarm, 51  
Firmware Upgrade, 68

## G

Gas Flow and Pressure Regulation, 20  
Gas Scale Factor, GSF, 69  
Graph Setup, 56  
GSF, 49

## H

Hydrogen Service, 89  
Hydrogen Service Safety System, 17

## I

In Calibration Relay, 56  
Installation and Setup, 13  
    Electrical Connections, 17  
    Pneumatic Pressure Gas Connections, 15  
    Sample Gas Connections, 15  
Isolate Analyzer, 37

## K

Key Lock, 25

## L

Logs, 46

## M

Manual Zero, Zero Manual, 41  
Moisture Alarm Setup, 52  
Moisture Data History Routine, 42  
Moisture Display Setup, 56  
Moisture Temperature Range Alarm, 53

## N

nitrogen case purge, 89

## O

Operating Voltage, 25  
Options, 25

## P

Power Up Default, 63, 64  
Pressure Alarm Setup, 53  
Pump Capacity Test, 60  
Pump Capacity Test Log, 48  
Pump case purge, 89

## R

Relay Ports, 33  
Relays, Test, 58  
Restore Sample Gas Flow, 38

## S

Safety, 79  
    Symbols and Explanations, 79  
Sample Gas Flammability, 70  
Sample Gas Preparation and Delivery, 69  
    Background Gas Effects, 69  
    Flow Rate Effects  
        Sensor Performance, 69  
    Sample Gas Flammability, 70  
    Sample GSF, 69  
Sample Gas Scale Factor, 49  
Sample GSF, 49, 69  
Serial Communications, 25  
Service, 71  
    Maintenance  
        Storage Conditions, 71  
    Replaceable Parts List, 73

Return Material Authorization number, 71  
Shipping, 75  
    Return Material Authorization number, 75

Set Location, 44  
Signal Monitor, 60  
Specifications, 9  
System Alarm Setup, 54  
System Error Codes, 47  
System Info, 67

## T

Test Analog Voltage Output, 59  
Test Relays, 58  
Theory of Moisture Measurement, 77

## U

User Interface, 35  
    Data Display Screen, 35  
    Keypad, 35  
    Main Menu, 36  
    Menu Structure, 36  
User Zero Offset, 40

## V

View Location, 45  
View Logs Menu, 46

## W

Warranty, 81

## Z

Zero Log, 46



# 14 Appendix A – User Menu Screens



Page 37



Page 38

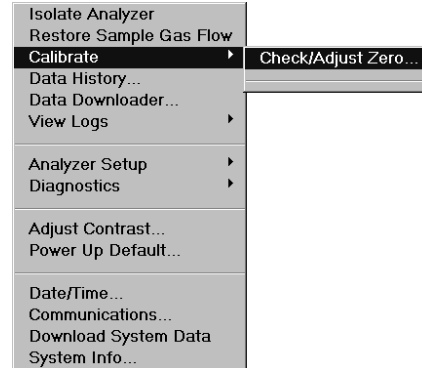

Page 39



Page 42

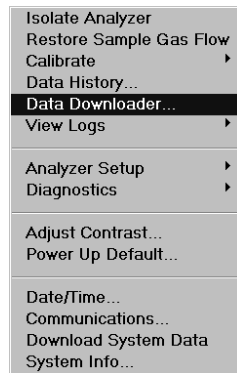

Page 44

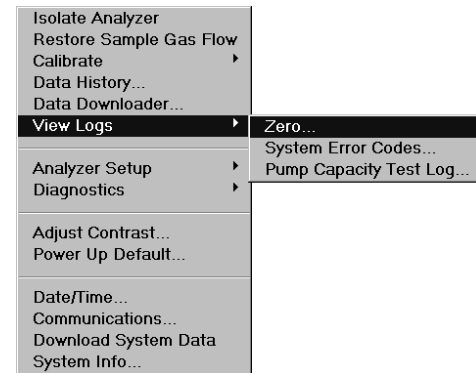

Page 46

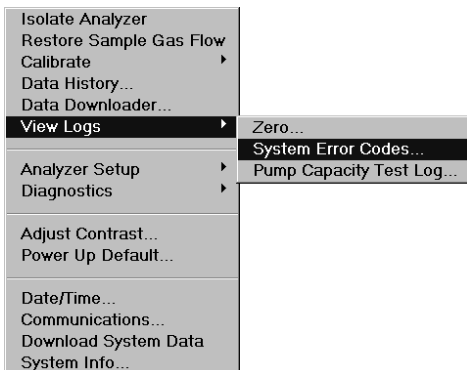

Page 47

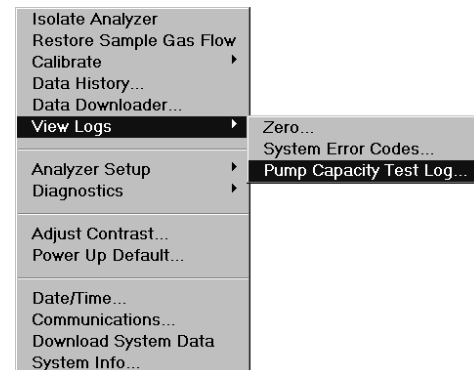

Page 48

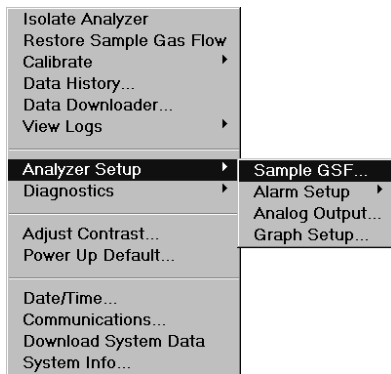

Page 49

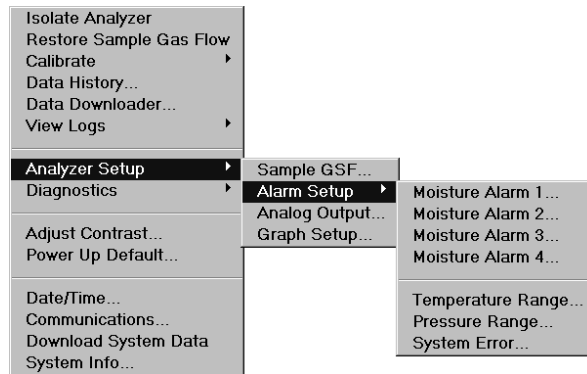

Page 51

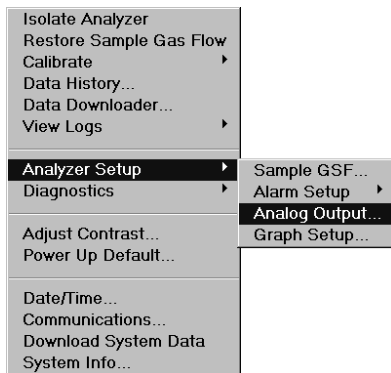

Page 55

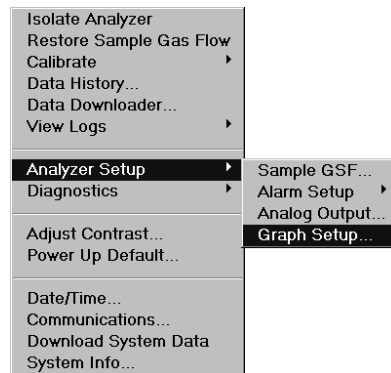

Page 56

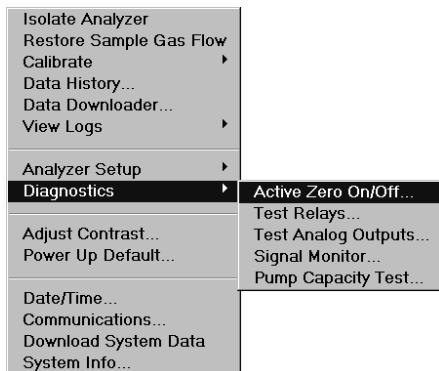

Page 57

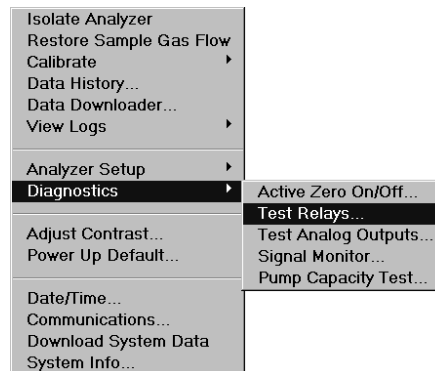

Page 58

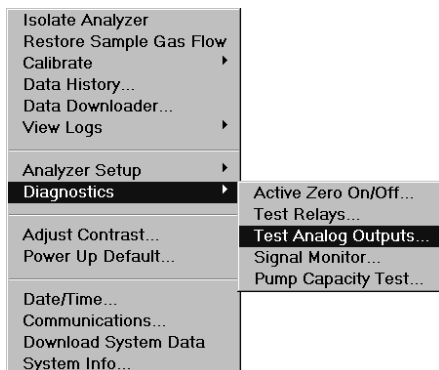

Page 59

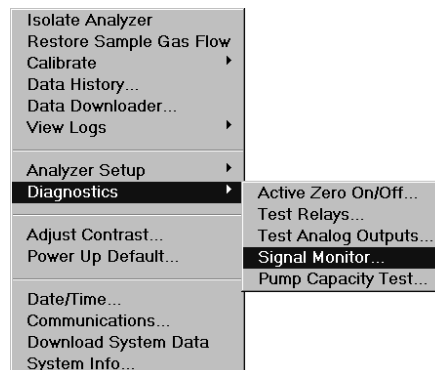

Page 60

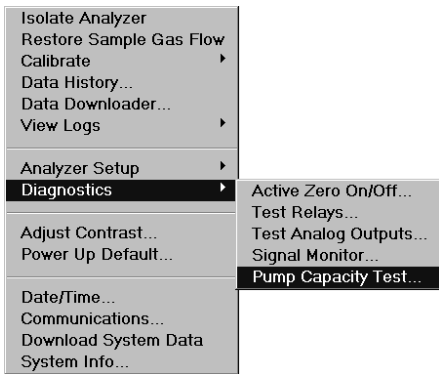

Page 60



Page 62

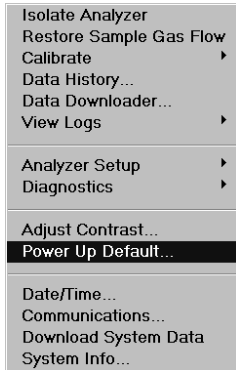

Page 63



Page 64



Page 65



Page 66



Page 67



# 15 Appendix B – Hydrogen Service Safety System

The **Hydrogen Service Safety System** is designed to safeguard the DF-745 from explosion hazards when operating on hydrogen sample gas under normal pressure and flow conditions as described in this manual. The instrument chassis and the remote pump, if equipped, are both protected by maintaining a safe condition within their respective enclosures.

If equipped with this option at the time of shipment from the factory, the analyzer will be set for Hydrogen operation through the GSF screen and the Hydrogen Safety Service System will automatically be enabled.

## 15.1 Instrument

- **Air circulation fans** pull air in through the front door (and vent through the rear) of the chassis. The fans are rated at 50 cfm (125 cfm max) which will maintain the internal chassis space below the lower explosive limit (LEL)<sup>1</sup>.
- **Sample delivery interlock valve** blocks flow of sample gas from entering the instrument chassis under various conditions as described below. It consists of a normally closed pneumatically actuated UHP springless diaphragm valve positioned on the sample inlet bulkhead.
- **Analyzer case purge valve** introduces nitrogen purge flow into the chassis upon closure of the sample delivery interlock valve. It consists of a normally open pneumatically actuated valve which feeds a customer supplied and regulated source of nitrogen purge gas through a bulkhead on the rear of the cabinet.<sup>2</sup>
- **Instrument controls and logic**<sup>3</sup> default, manage and actuate the above mentioned components to maintain safe operating conditions.

## 15.2 Vacuum Pump

- If equipped with a vacuum pump, **an enclosure** equipped with a nitrogen case purge is provided for the vacuum pump to maintain a safe condition. In addition, an interlock is provided to detect and react to loss of Nitrogen purge flow. See Figure 86 on page 94.

## 15.3 Installation

If equipped with this safety system, the analyzer installation procedure is modified as follows:

- The pump enclosure must be mounted to a nearby wall or inside the rack shared by the analyzer. See Figure 86 on page 94.
- The sample gas inlet connection is made to an interlock valve mounted at the sample gas inlet on the rear of the analyzer. NOTE: The installation of this option changes the sample inlet connection to female VCR, from male.
- The sample gas outlet is connected by a ¼ inch metal tube from the analyzer sample outlet, to the needle control valve (supplied loose), and then to the sample inlet on the pump enclosure.
- A customer supplied and regulated source of nitrogen purge gas is connected to both the ¼ inch compression fitting on the case purge valve mounted on the rear of the analyzer as well as to the 1/8 inch compression purge inlet fitting on the vacuum pump enclosure.
- If required, the pump enclosure sample outlet and/or analyzer sample outlet need to be connected by ¼ inch metal tube and compression fittings to an appropriate exhaust system.
- The pump power cord is connected from the rear of the analyzer to the pump enclosure.

## 15.4 Operation

- Before power is applied to the analyzer, the moisture cell is in an isolated state as the internal inlet and outlet valves are closed. In addition, the external sample interlock valve is closed and the case purge valve is open allowing customer supplied and regulated Nitrogen gas to purge the analyzer cabinet.

When power is applied, and only after the system has verified proper exhaust fan operation, the system automatically opens the external sample interlock valve to enable gas flow and the case purge valve is closed.

NOTE: The back flow prevention screen will be displayed and the user must hit ESC to acknowledge the screen and remove it.

After approx. 5 minutes, the Warming Up indication will disappear and the user is then free to open the internal inlet and outlet valves to the moisture cell.

- On analyzer shut-down, or in the event of a power failure or fan failure, the moisture cell is automatically isolated with internal valves, the external sample interlock valve closes to block sample flow from entering, and the purge valve opens to allow Nitrogen purge into the analyzer enclosure.
- The pump case purge system continuously feeds a customer regulated supply of nitrogen into the pump enclosure to (1) maintain the oxygen level well below the maximum safe level (5% for hydrogen) in the event that the pump diaphragm fails and leaks sample gas into the enclosure and (2) maintain appropriate flow for

adequate pump cooling. The purge flow rate is set to 30 scfh as indicated on a rotometer mounted on the side of the pump enclosure. An in-line flow switch will trip at a flow rate of less than 26 scfh assuring adequate flow. Loss of purge flow breaks the contacts in the flow switch, which in turn trips a mercury relay that removes power to the pump.

- To disable the Hydrogen Safety Service System, use the GSF screen to indicate that hydrogen is not included in the process gas by entering 0%. See page 49 for additional information on setting GSF.

#### **CAUTION**



The purge flow out of the pump enclosure may contain sample gas and should be appropriately vented.

#### **CAUTION**



After passing through the moisture cell and orifice, the sample is under vacuum and any leak in the system would result in ingress of ambient rather than release of sample gas to ambient. Accordingly, the sample outlet should be vented appropriately to assure adequate dilution.

#### **CAUTION**



The Hydrogen Service Safety System is designed to be safe as provided by the factory when operating as described in the Operating Instruction Manual. **DO NOT** make additional penetrations in the enclosure. If there is a need to do so, please contact the factory. Additional penetrations made in the enclosure (or failure to properly fasten the enclosure door) will allow additional influx of ambient oxygen and may defeat the case purge safety mechanism. A pressure relief valve is installed to prevent over pressurization of the enclosure.

#### **CAUTION**



Do not open the pump enclosure door unless AC power is shut off.

## CAUTION



The operator is obligated to assure proper operation of the analyzer air flow system as designed. Do not impede air flow at the inlet in the front door or at the exhaust fan outlets on either side of the cabinet in the rear.

## NOTES

<sup>1</sup> For hydrogen, which has a lower explosive limit (LEL) of 4%, the maximum allowable influx in event of an internal leak would be 120 scfh, whereas the normal flow as defined in the Operating Instruction Manual is about 1/10<sup>th</sup> that at approximately 14 scfh.

<sup>2</sup> Use of the analyzer case purge is at the customer's discretion. It most likely is not necessary since in the event of sample delivery interlock, the sample feed is blocked from entering the chassis and the only open flow path through the system is dissipation of remaining sample in the bypass, which would be vented externally, or in the event of an internal leak, would be volumetrically insignificant.

<sup>3</sup> The pneumatic control for the sample interlock and case purge valves is provided by an internal 12 VDC solenoid.



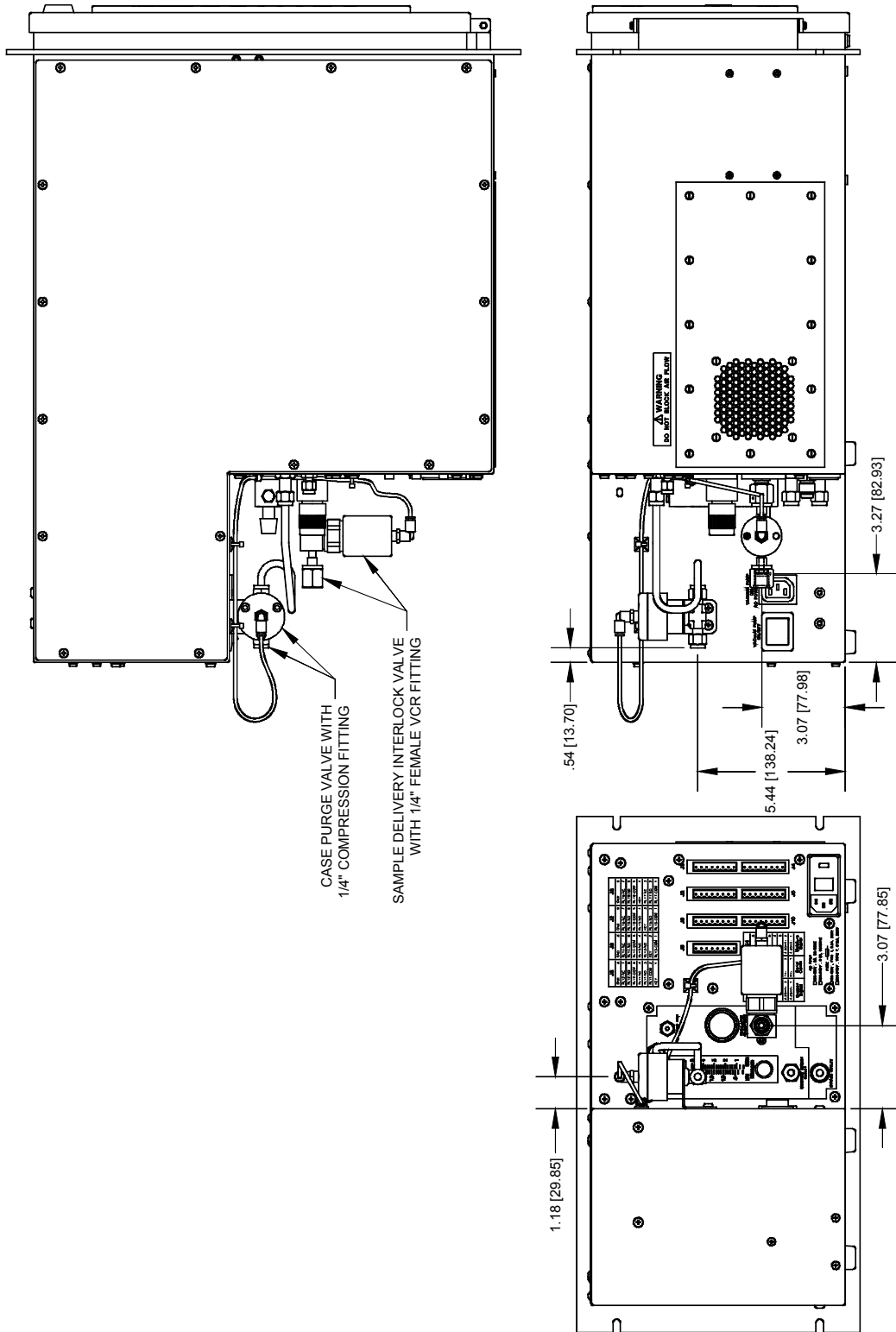

Figure 85: Hydrogen Service Safety System



## Free Manuals Download Website

<http://myh66.com>

<http://usermanuals.us>

<http://www.somanuals.com>

<http://www.4manuals.cc>

<http://www.manual-lib.com>

<http://www.404manual.com>

<http://www.luxmanual.com>

<http://aubethermostatmanual.com>

Golf course search by state

<http://golfingnear.com>

Email search by domain

<http://emailbydomain.com>

Auto manuals search

<http://auto.somanuals.com>

TV manuals search

<http://tv.somanuals.com>