

# 16" Variable Speed Scroll Saw with Quickset II® Blade Changing Feature (Model SS250)

INSTRUCTION MANUAL



PART NO. 905574 - 05-03-02  
Copyright © 2002 Delta Machinery

 **DELTA**® *ShopMaster*™

To learn more about DELTA MACHINERY  
visit our website at: [www.deltamachinery.com](http://www.deltamachinery.com).

For Parts, Service, Warranty or other Assistance,

please call **1-800-223-7278** (In Canada call **1-800-463-3582**).

**ESPAÑOL: PÁGINA 21**

# GENERAL SAFETY RULES

Woodworking can be dangerous if safe and proper operating procedures are not followed. As with all machinery, there are certain hazards involved with the operation of the product. Using the machine with respect and caution will considerably lessen the possibility of personal injury. However, if normal safety precautions are overlooked or ignored, personal injury to the operator may result. Safety equipment such as guards, push sticks, hold-downs, featherboards, goggles, dust masks and hearing protection can reduce your potential for injury. But even the best guard won't make up for poor judgment, carelessness or inattention. Always use common sense and exercise caution in the workshop. If a procedure feels dangerous, don't try it. Figure out an alternative procedure that feels safer. **REMEMBER:** Your personal safety is your responsibility.

This machine was designed for certain applications only. Delta Machinery strongly recommends that this machine not be modified and/or used for any application other than that for which it was designed. If you have any questions relative to a particular application, **DO NOT** use the machine until you have first contacted Delta to determine if it can or should be performed on the product.

**Technical Service Manager  
Delta Machinery  
4825 Highway 45 North  
Jackson, TN 38305**

(IN CANADA: 505 SOUTHGATE DRIVE, GUELPH, ONTARIO N1H 6M7)



## **WARNING: FAILURE TO FOLLOW THESE RULES MAY RESULT IN SERIOUS PERSONAL INJURY**

1. **FOR YOUR OWN SAFETY, READ INSTRUCTION MANUAL BEFORE OPERATING THE TOOL.** Learn the tool's application and limitations as well as the specific hazards peculiar to it.

2. **KEEP GUARDS IN PLACE** and in working order.

3. **ALWAYS WEAR EYE PROTECTION.** Wear safety glasses. Everyday eyeglasses only have impact resistant lenses; they are not safety glasses. Also use face or dust mask if cutting operation is dusty. These safety glasses must conform to ANSI Z87.1 requirements. **NOTE:** Approved glasses have Z87 printed or stamped on them.

4. **REMOVE ADJUSTING KEYS AND WRENCHES.** Form habit of checking to see that keys and adjusting wrenches are removed from tool before turning it "on".

5. **KEEP WORK AREA CLEAN.** Cluttered areas and benches invite accidents.

6. **DON'T USE IN DANGEROUS ENVIRONMENT.** Don't use power tools in damp or wet locations, or expose them to rain. Keep work area well-lighted.

7. **KEEP CHILDREN AND VISITORS AWAY.** All children and visitors should be kept a safe distance from work area.

8. **MAKE WORKSHOP CHILDPROOF** – with padlocks, master switches, or by removing starter keys.

9. **DON'T FORCE TOOL.** It will do the job better and be safer at the rate for which it was designed.

10. **USE RIGHT TOOL.** Don't force tool or attachment to do a job for which it was not designed.

11. **WEAR PROPER APPAREL.** No loose clothing, gloves, neckties, rings, bracelets, or other jewelry to get caught in moving parts. Nonslip footwear is recommended. Wear protective hair covering to contain long hair.

12. **SECURE WORK.** Use clamps or a vise to hold work when practical. It's safer than using your hand and frees both hands to operate tool.

13. **DON'T OVERREACH.** Keep proper footing and balance at all times.

14. **MAINTAIN TOOLS IN TOP CONDITION.** Keep tools sharp and clean for best and safest performance. Follow instructions for lubricating and changing accessories.

15. **DISCONNECT TOOLS** before servicing and when changing accessories such as blades, bits, cutters, etc.

16. **USE RECOMMENDED ACCESSORIES.** The use of accessories and attachments not recommended by Delta may cause hazards or risk of injury to persons.

17. **REDUCE THE RISK OF UNINTENTIONAL STARTING.** Make sure switch is in "OFF" position before plugging in power cord. In the event of a power failure, move switch to the "OFF" position.

18. **NEVER STAND ON TOOL.** Serious injury could occur if the tool is tipped or if the cutting tool is accidentally contacted.

19. **CHECK DAMAGED PARTS.** Before further use of the tool, a guard or other part that is damaged should be carefully checked to ensure that it will operate properly and perform its intended function – check for alignment of moving parts, binding of moving parts, breakage of parts, mounting, and any other conditions that may affect its operation. A guard or other part that is damaged should be properly repaired or replaced.

20. **DIRECTION OF FEED.** Feed work into a blade or cutter against the direction of rotation of the blade or cutter only.

21. **NEVER LEAVE TOOL RUNNING UNATTENDED. TURN POWER OFF.** Don't leave tool until it comes to a complete stop.

22. **STAY ALERT, WATCH WHAT YOU ARE DOING, AND USE COMMON SENSE WHEN OPERATING A POWER TOOL. DO NOT USE TOOL WHILE TIRED OR UNDER THE INFLUENCE OF DRUGS, ALCOHOL, OR MEDICATION.** A moment of inattention while operating power tools may result in serious personal injury.

23. **MAKE SURE TOOL IS DISCONNECTED FROM POWER SUPPLY** while motor is being mounted, connected or reconnected.

24. **THE DUST GENERATED** by certain woods and wood products can be injurious to your health. Always operate machinery in well ventilated areas and provide for proper dust removal. Use wood dust collection systems whenever possible.

25.  **WARNING: SOME DUST CREATED BY POWER SANDING, SAWING, GRINDING, DRILLING, AND OTHER CONSTRUCTION ACTIVITIES** contains chemicals known to cause cancer, birth defects or other reproductive harm. Some examples of these chemicals are:

- lead from lead-based paints,
  - crystalline silica from bricks and cement and other masonry products, and
  - arsenic and chromium from chemically-treated lumber.
- Your risk from these exposures varies, depending on how often you do this type of work. To reduce your exposure to these chemicals: work in a well ventilated area, and work with approved safety equipment, such as those dust masks that are specially designed to filter out microscopic particles.

**SAVE THESE INSTRUCTIONS.**

**Refer to them often and use them to instruct others.**

# ADDITIONAL SAFETY RULES FOR SCROLL SAWS



**WARNING: FAILURE TO FOLLOW THESE RULES MAY RESULT IN SERIOUS PERSONAL INJURY.**

1. **DO NOT OPERATE** your scroll saw until it is completely assembled and installed according to the instructions.
2. **IF YOU ARE NOT** thoroughly familiar with the operation of Scroll Saws, obtain advice from your supervisor, instructor or other qualified person.
3. **YOUR SCROLL SAW MUST** be securely fastened to a stand or workbench. If there is any tendency for the stand or workbench to move during operation, the stand or workbench **MUST** be fastened to the floor.
4. **THIS SCROLL SAW** is intended for indoor use only.
5. **MAKE SURE** blade is properly tensioned before operating saw.
6. **TO AVOID** blade breakage **ALWAYS** adjust blade tension correctly.
7. **MAKE SURE** the blade teeth point downward toward the table.
8. **NEVER** turn the saw "ON" before clearing the table of all objects (tools, scraps of wood, etc.).
9. **DO NOT** cut material that is too small to be safely supported.
10. **AVOID** awkward hand positions where a sudden slip could cause a hand to move into the blade.
11. **ALWAYS** keep hands and fingers away from blade.
12. **ALWAYS** adjust holddown foot for each new operation.
13. **DO NOT USE** dull or bent blades.
14. **DO NOT** attempt to saw material that does not have a flat surface, unless a suitable support is used.
15. **MAKE** "relief" cuts before cutting long curves.
16. **NEVER** attempt to cut a curve that is too tight for the blade being used.
17. **WHEN** backing a blade out of a workpiece, the blade may bind in the saw kerf. This is usually caused by sawdust in the kerf. If this happens, turn "OFF" the switch and remove plug from power source outlet. Wedge open the kerf and back blade out of the workpiece.
18. **THE USE** of attachments and accessories not recommended by Delta may result in the risk of injuries.
19. **ALWAYS** hold the work firmly against the table.
20. **DO NOT** feed the material too fast while cutting. Only feed the material fast enough so that the blade will cut.
21. **NEVER** start the Scroll Saw with the stock pressed against the blade.
22. **WHEN** cutting a large workpiece **MAKE SURE** the material is supported at table height.
23. **USE CAUTION** when cutting material which is irregular in cross section which could pinch the blade before the cut is completed. A piece of moulding for example must lay flat on the table and not be permitted to rock while being cut.
24. **USE CAUTION** when cutting round material such as dowel rods or tubing. They have a tendency to roll while being cut causing the blade to "bite." Use a V-block to control the piece.
25. **ALWAYS** release blade tension before removing the blade from the upper or lower blade holders.
26. **MAKE CERTAIN** table tilting lock is tightened before starting the machine.
27. **NEVER** reach under the table while the machine is running.
28. **NEVER** perform layout, assembly or set-up work on the table while the saw is operating.
29. **ALWAYS STOP** the saw before removing scrap pieces from the table.
30. **WHEN THE TOOL IS NOT IN USE**, the switch should be locked in the "OFF" position to prevent unauthorized use.
31. **SHOULD** any part of your Scroll Saw be missing, damaged or fail in any way, or any electrical component fail to perform properly, shut off switch and remove plug from power supply outlet. Replace missing, damaged or failed parts before resuming operation.
32. **ADDITIONAL INFORMATION** regarding the safe and proper operation of this product is available from the National Safety Council, 1121 Spring Lake Drive, Itasca, IL 60143-3201, in the Accident Prevention Manual for Industrial Operations and also in the Safety Data Sheets provided by the NSC. Please also refer to the American National Standards Institute ANSI O1.1 Safety Requirements for Woodworking Machinery and the U.S. Department of Labor OSHA 1910.213 Regulations.

**SAVE THESE INSTRUCTIONS.  
Refer to them often  
and use them to instruct others.**

# POWER CONNECTIONS

A separate electrical circuit should be used for your machines. This circuit should not be less than #12 wire and should be protected with a 20 Amp time lag fuse. If an extension cord is used, use only 3-wire extension cords which have 3-prong grounding type plugs and matching receptacle which will accept the machine's plug. Before connecting the motor to the power line, make sure the switch is in the "OFF" position and be sure that the electric current is of the same characteristics as indicated on the machine. All line connections should make good contact. Running on low voltage will damage the motor.

 **WARNING: DO NOT EXPOSE THE MACHINE TO RAIN OR OPERATE THE MACHINE IN DAMP LOCATIONS.**

## MOTOR SPECIFICATIONS

Your machine is wired for 120 volt, 60 HZ alternating current. Before connecting the machine to the power source, make sure the switch is in the "OFF" position.

## GROUNDING INSTRUCTIONS

 **WARNING: THIS MACHINE MUST BE GROUNDED WHILE IN USE TO PROTECT THE OPERATOR FROM ELECTRIC SHOCK.**

1. All grounded, cord-connected machines:

In the event of a malfunction or breakdown, grounding provides a path of least resistance for electric current to reduce the risk of electric shock. This machine is equipped with an electric cord having an equipment-grounding conductor and a grounding plug. The plug must be plugged into a matching outlet that is properly installed and grounded in accordance with all local codes and ordinances.

Do not modify the plug provided - if it will not fit the outlet, have the proper outlet installed by a qualified electrician.

Improper connection of the equipment-grounding conductor can result in risk of electric shock. The conductor with insulation having an outer surface that is green with or without yellow stripes is the equipment-grounding conductor. If repair or replacement of the electric cord or plug is necessary, do not connect the equipment-grounding conductor to a live terminal.

Check with a qualified electrician or service personnel if the grounding instructions are not completely understood, or if in doubt as to whether the machine is properly grounded.

Use only 3-wire extension cords that have 3-prong grounding type plugs and matching 3-conductor receptacles that accept the machine's plug, as shown in Fig. A.

Repair or replace damaged or worn cord immediately.

2. Grounded, cord-connected machines intended for use on a supply circuit having a nominal rating less than 150 volts:

If the machine is intended for use on a circuit that has an outlet that looks like the one illustrated in Fig. A, the machine will have a grounding plug that looks like the plug illustrated in Fig. A. A temporary adapter, which looks like the adapter illustrated in Fig. B, may be used to connect this plug to a matching 2-conductor receptacle as shown in Fig. B if a properly grounded outlet is not available. The temporary adapter should be used only until a properly grounded outlet can be installed by a qualified electrician. The green-colored rigid ear, lug, and the like, extending from the adapter must be connected to a permanent ground such as a properly grounded outlet box. Whenever the adapter is used, it must be held in place with a metal screw.

**NOTE: In Canada, the use of a temporary adapter is not permitted by the Canadian Electric Code.**

 **WARNING: IN ALL CASES, MAKE CERTAIN THE RECEPTACLE IN QUESTION IS PROPERLY GROUNDED. IF YOU ARE NOT SURE HAVE A QUALIFIED ELECTRICIAN CHECK THE RECEPTACLE.**

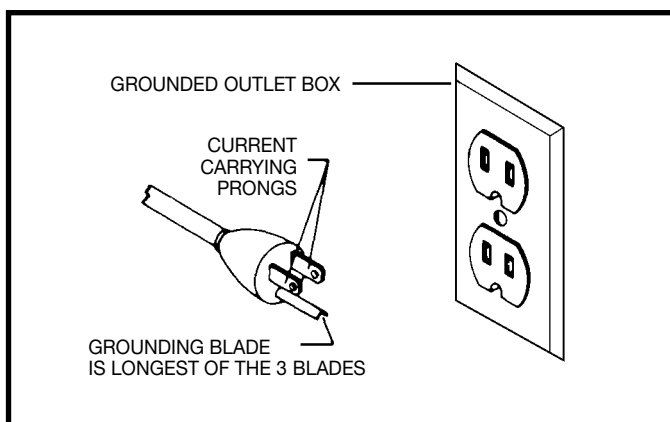

Fig. A

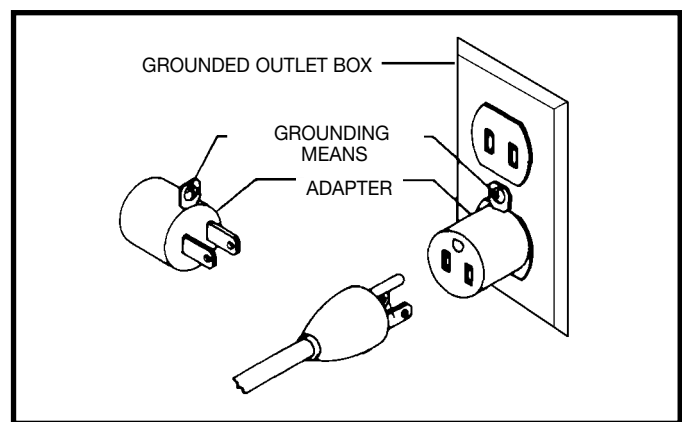

Fig. B

# EXTENSION CORDS

Use proper extension cords. Make sure your extension cord is in good condition and is a 3-wire extension cord which has a 3-prong grounding type plug and matching receptacle which will accept the machine's plug. When using an extension cord, be sure to use one heavy enough to carry the current of the machine. An undersized cord will cause a drop in line voltage, resulting in loss of power and overheating. Fig. D, shows the correct gauge to use depending on the cord length. If in doubt, use the next heavier gauge. The smaller the gauge number, the heavier the cord.

<b>MINIMUM GAUGE EXTENSION CORD</b>			
RECOMMENDED SIZES FOR USE WITH STATIONARY ELECTRIC MACHINES			
Ampere Rating	Volts	Total Length of Cord in Feet	Gauge of Extension Cord
0-6	120	up to 25	18 AWG
0-6	120	25-50	16 AWG
0-6	120	50-100	16 AWG
0-6	120	100-150	14 AWG
6-10	120	up to 25	18 AWG
6-10	120	25-50	16 AWG
6-10	120	50-100	14 AWG
6-10	120	100-150	12 AWG
10-12	120	up to 25	16 AWG
10-12	120	25-50	16 AWG
10-12	120	50-100	14 AWG
10-12	120	100-150	12 AWG
12-16	120	up to 25	14 AWG
12-16	120	25-50	12 AWG
12-16	120	GREATER THAN 50 FEET NOT RECOMMENDED	

Fig. D

# OPERATING INSTRUCTIONS

## FOREWORD

Delta ShopMaster Model SS250 is a 16" variable speed scroll saw. The variable speed range for the Model SS250 is 400-1800 cutting strokes per minute. The Model SS250 offers a full 2" depth of cut for thick workpieces.

## UNPACKING AND CLEANING

Carefully unpack the machine and all loose items from the shipping container(s). Remove the protective coating from all unpainted surfaces. This coating may be removed with a soft cloth moistened with kerosene (do not use acetone, gasoline or lacquer thinner for this purpose). After cleaning, cover the unpainted surfaces with a good quality household floor paste wax.

**NOTICE: THE MANUAL COVER PHOTO ILLUSTRATES THE CURRENT PRODUCTION MODEL. ALL OTHER ILLUSTRATIONS ARE REPRESENTATIVE ONLY AND MAY NOT DEPICT THE ACTUAL COLOR, LABELING OR ACCESSORIES AND MAY BE INTENDED TO ILLUSTRATE TECHNIQUE ONLY.**

# SCROLL SAW PARTS



Fig. 1

**Fig. 1**

1. Scroll Saw with blade attached

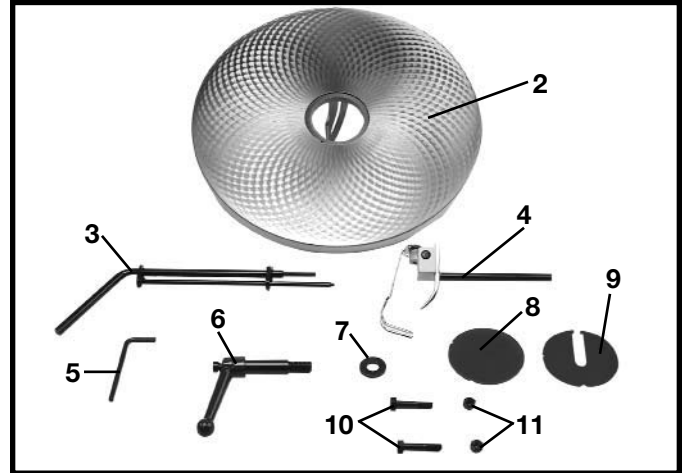

Fig. 2

**Fig. 2**

2. Table
3. Quickset Blade Changing Wrench
4. Holddown Rod
5. 4mm Hex Wrench
6. Locking Handle
7. M10 Flat Washer
8. Blank Table Insert
9. Table Insert
10. Special Screw M6x1x45mm (2)
11. M6 Locknut (2)

# ASSEMBLY

1. Remove the blade from the scroll saw.
2. Move the blade lever tension handle (A) Fig. 3, to the forward position as shown.

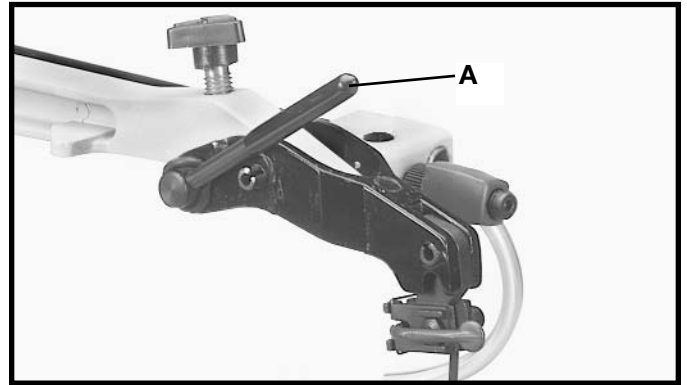

Fig. 3

3. Push chuck locking lever (B) Fig. 4 to the rear as shown. This will release the blade (C) from the upper chuck assembly (D).

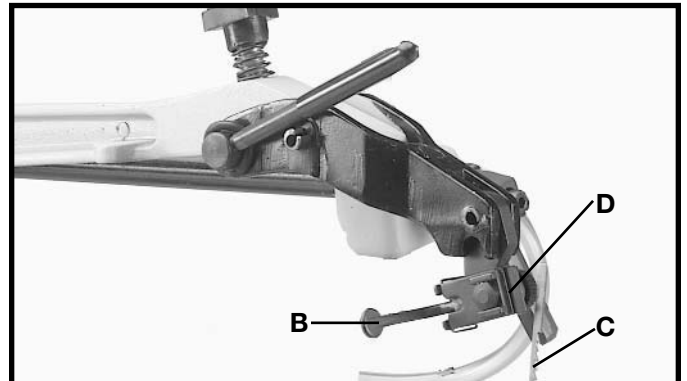

Fig. 4

4. Insert long end (F) Fig. 5, of quickset blade changing wrench into hole (G) in lower blade holder. This will align wrench (H) with blade holder screw (J). Turn wrench (H) counter-clockwise. This will release the blade from the lower chuck assembly.

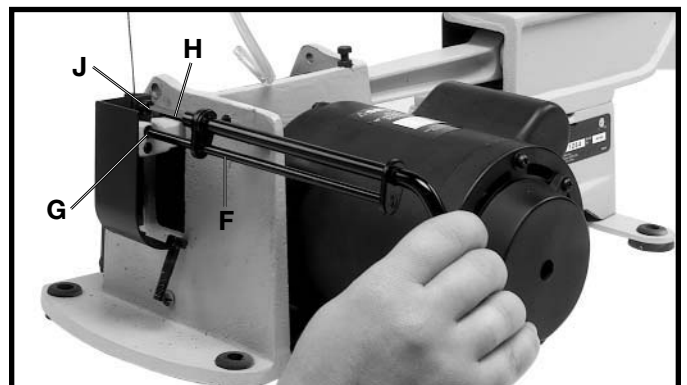

Fig. 5

5. Position table (A) Fig. 7, on the machine as shown. Align the two holes in the table trunnions (O) with the two holes in the base (P) of the machine. **NOTE: BEFORE TIGHTENING THE M6x1x45mm SPECIAL SCREWS (B) AND M6 LOCKNUTS (C) FIG. 7, MAKE SURE THE TILT SCALE (D) FIG. 7, IS POSITIONED INSIDE POINTER (E) AS SHOWN. ALSO, DO NOT COMPLETELY TIGHTEN THE M6x1x45mm SPECIAL SCREWS (B) AND M6 LOCKNUTS (C). TABLE MUST BE ABLE TO TILT FREELY.** Fasten the table (A) Fig. 7, to the base (P), using the two M6x1x45mm special screws (B), and M6 locknuts (C) as shown.

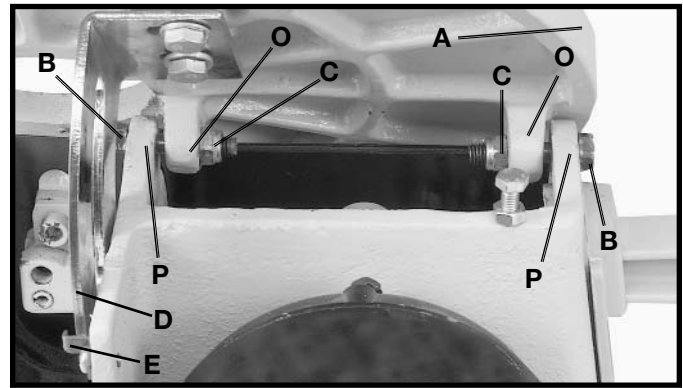

Fig. 7

6. Disassemble the handle by unscrewing and removing screw and spring (F), and handle (G) from locking stud (H), as shown in Fig. 8. Place a M10 flat washer (J) on threaded end of stud (H).

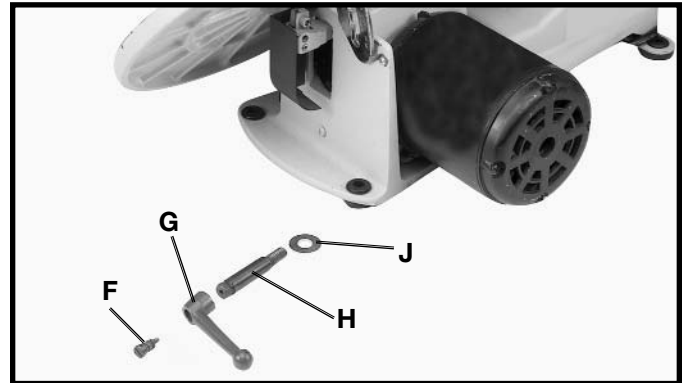

Fig. 8

7. Screw threaded end of stud (H) Fig. 9, with the M10 flat washer (J) through slot in angle of tilt scale (D) and into tapped hole (K).

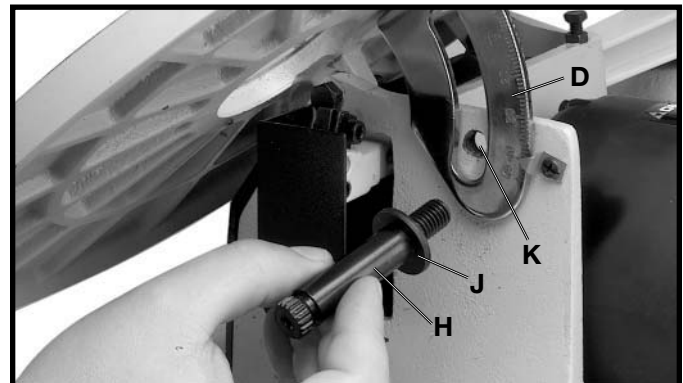

Fig. 9

8. Place handle (G) Fig. 10, onto locking stud (H) and fasten with screw and spring (F). Move table (A) to the horizontal position and lock table (A), by turning handle (G) clockwise.

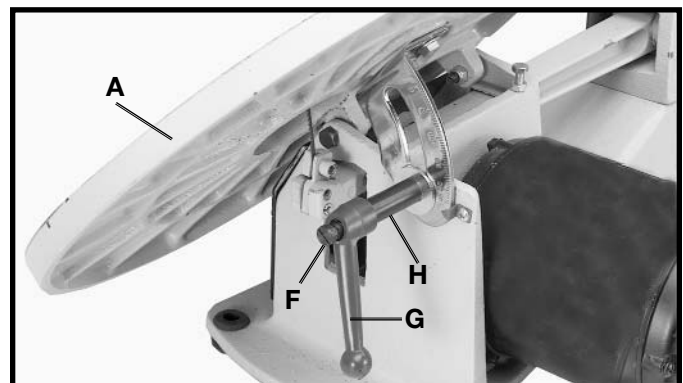

Fig. 10



9. Using the 4mm wrench (L) Fig. 11, loosen the two screws (P) on bottom of bracket (M) that fasten bracket to rod (N).

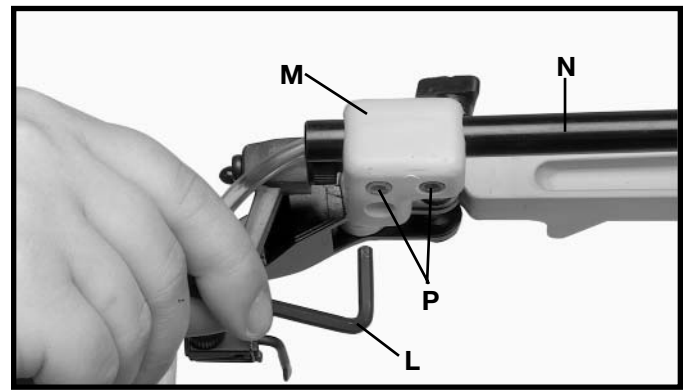

Fig. 11

10. Rotate bracket (M), to the position shown in Fig. 12. Loosen lock handle (R) and insert holddown rod (S) into hole in bracket (M), as shown.

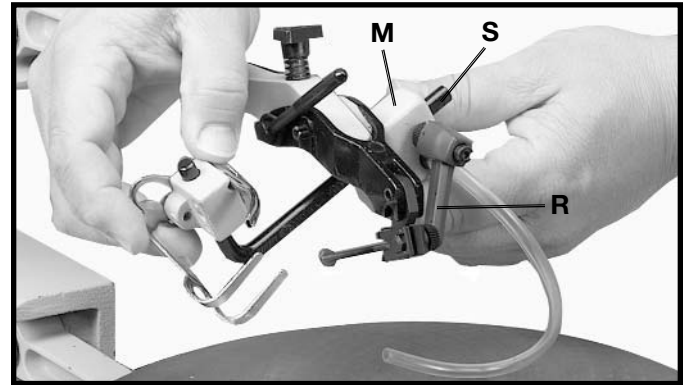

Fig. 12

11. Rotate bracket (M) Fig. 13, back to its original position as shown, and tighten the two screws that were loosened in **STEP 9**. Then tighten lockhandle (R) to hold rod (S) in position.

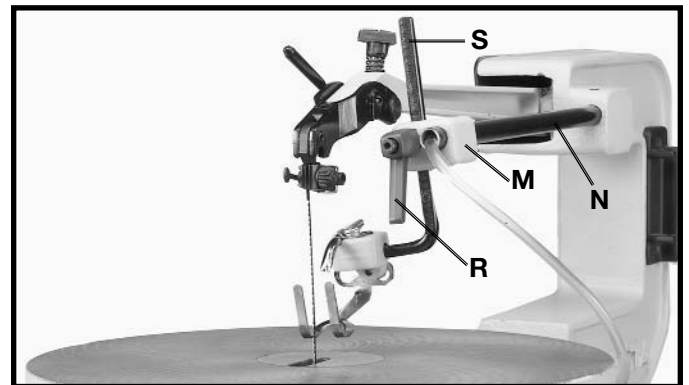

Fig. 13

12. Slide end of chip blower tube (T) Fig. 14, onto end of air nozzle (V), as shown.

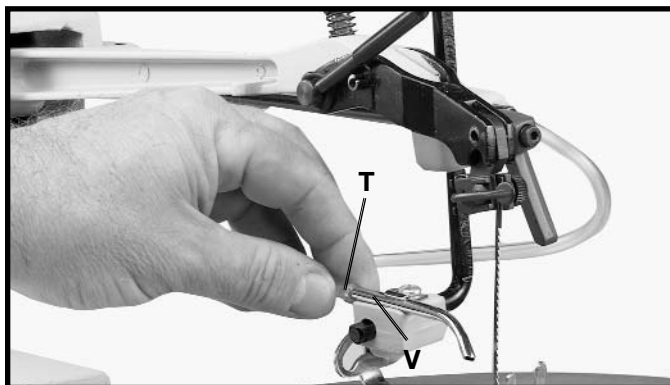

Fig. 14

13. The tool holder (X) Fig. 15, is used to hold the quickset blade changing wrench (Y), (for removing blade from lower blade holder), 4mm allen wrench (W) and extra blades (Z).

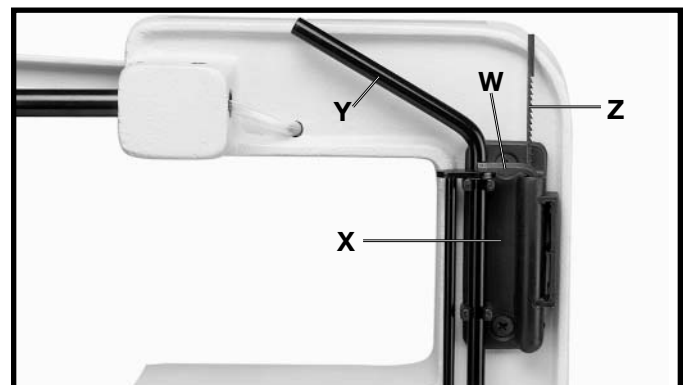

Fig. 15

## FASTENING SCROLL SAW TO SUPPORTING SURFACE

Your scroll saw **MUST** be securely fastened to a stand or workbench using the holes in the four rubber feet, three of which are shown at (A) Fig. 16. **IMPORTANT:** When mounting the saw to a stand or workbench **DO NOT** over-tighten mounting bolts. Leave some cushion in the four rubber feet (A) for absorbing noise and vibration.

An alternate method of securing the scroll saw is to clamp the front and side ledges of the scroll saw to a supporting surface with C-clamps.

**IMPORTANT:** If there is any tendency for the stand or workbench to move during operation, the stand or workbench must be fastened to the floor.



Fig. 16

## OPERATING CONTROLS AND ADJUSTMENTS

### ON-OFF AND VARIABLE SPEED SWITCHES

The on-off switch (A) Fig. 17, and variable speed switch (B) is located on the right side of the scroll saw base, as shown. To turn the saw "ON," push the switch (A) up to the "ON" position. To turn the saw "OFF", push the switch (A) down to the "OFF" position.

The scroll saw is equipped with a variable speed control knob (B) Fig. 17. The variable speed range is 400 to 1800 strokes per minute. When the variable speed knob (B) Fig. 17, is rotated all the way to the left (counterclockwise) the speed will be 400 strokes per minute. To increase the speed, rotate knob (B) to the right (clockwise) until the desired speed is obtained. When the knob (B) is rotated all the way to the right (clockwise) the speed will be 1800 strokes per minute.

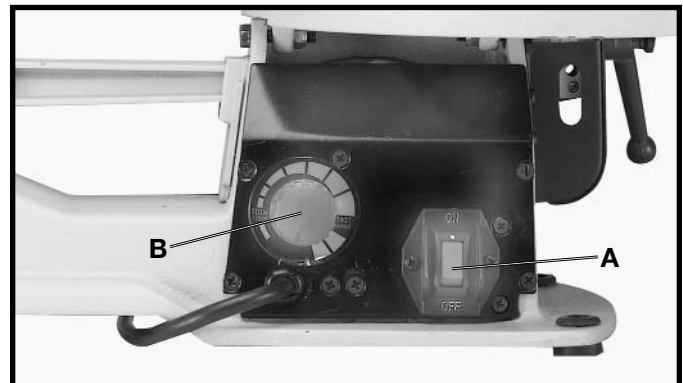

Fig. 17

### LOCKING ON-OFF SWITCH IN THE "OFF" POSITION

**IMPORTANT:** When the machine is not in use, the switch should be locked in the OFF position using a padlock (C) Fig. 18, with a 3/16" diameter shackle to prevent unauthorized use.



Fig. 18

## TABLE INSERT

The table insert (A) can be assembled to the saw table with the opening in the insert pointing to the front of the table, as shown in Fig. 19, or to the right as shown in Fig. 20.

With the table in the level position, 90 degrees to the blade, the insert (A) should be positioned, as shown in Fig. 19. This allows for the blade to be pivoted forward after it is unclamped from the top blade holder, enabling you to quickly insert the blade into the next hole in a pattern when doing inside-cutting.

When tilting the table for bevel cutting operations the insert (A) should be positioned as shown in Fig. 20. This allows for clearance of the blade when the table is tilting.

A table insert blank (B) Fig. 21, is supplied as standard equipment with your scroll saw and can be used when cutting very small workpieces to give added support to the bottom of the workpiece. Cut a slot into the blank and replace the standard insert (A) with the blank (B). The slot cut into the blank (B) will only be as wide as the blade giving maximum support to the bottom of the workpiece.

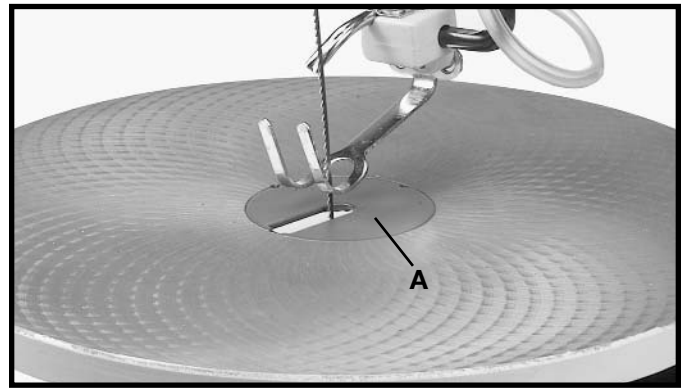

Fig. 19

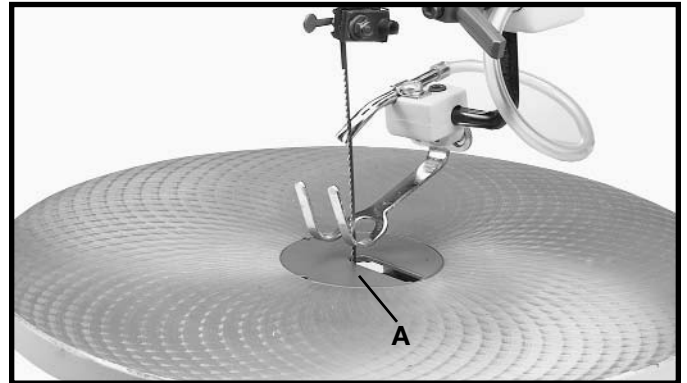

Fig. 20

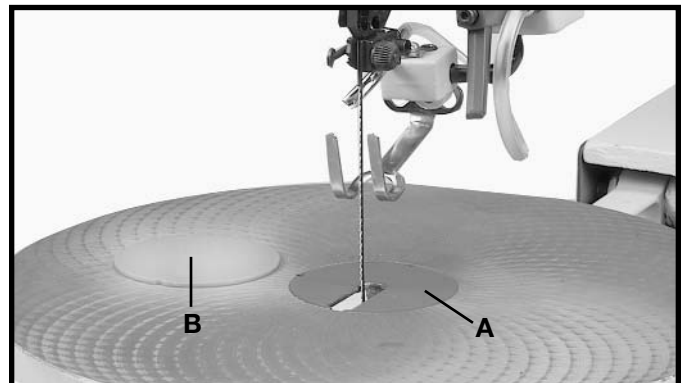

Fig. 21

## CHANGING BLADES

1. **DISCONNECT MACHINE FROM POWER SOURCE.**
2. Remove table insert (A) Fig. 22, and release blade tension by pulling tension lever (B) forward, as shown.

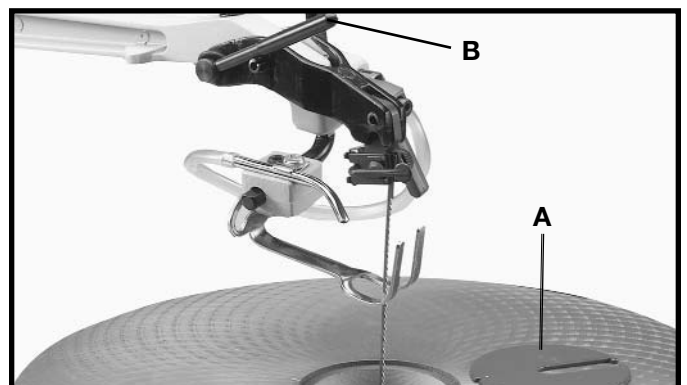

Fig. 22

3. Push chuck locking lever (C) Fig. 23, to the rear as shown. This will release the blade (D) from the upper chuck (E).

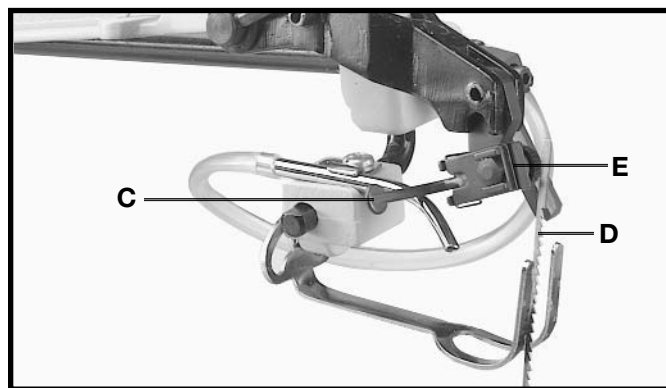

Fig. 23

4. Insert long end (F) Fig. 24, of quickset blade wrench into hole (G) in lower blade holder. This will align wrench (H) with blade holder screw (J).

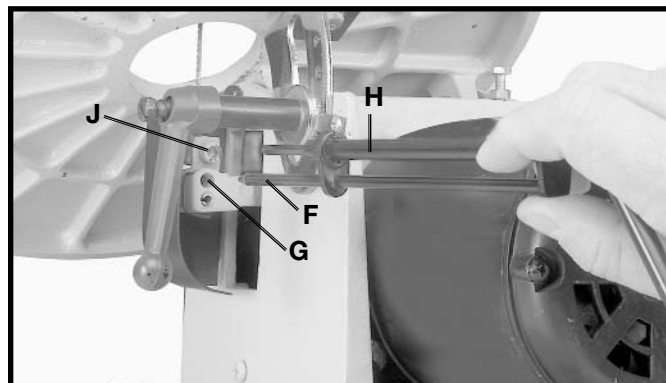

Fig. 24

5. Fig. 25 illustrates the quickset blade changing wrench (K) engaged with the lower blade holder assembly. Turn wrench counterclockwise to loosen screw (J) Figs. 24 and 25, and remove blade from lower chuck.

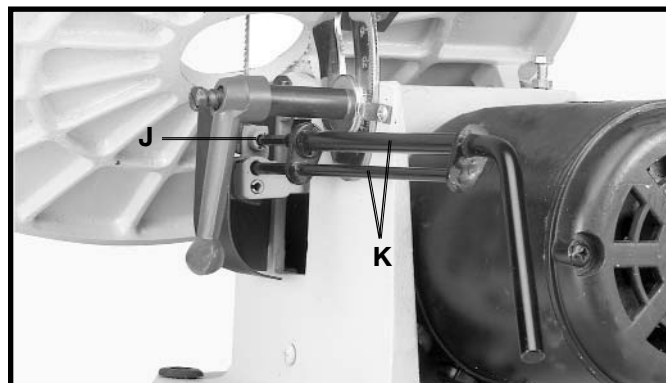

Fig. 25

6. Insert new blade into the lower and upper blade holders in the same manner, making certain the blade teeth are pointing down toward the table.

7. Tighten screw (J) Fig. 26, in lower blade guard assembly.

8. Push chuck locking lever (C) Fig. 23, to the forward position, to lock the blade in the upper blade holder assembly.

9. Replace the table insert that was removed in **STEP 2**.

10. Apply blade tension by referring to the following section "**ADJUSTING BLADE TENSION.**"

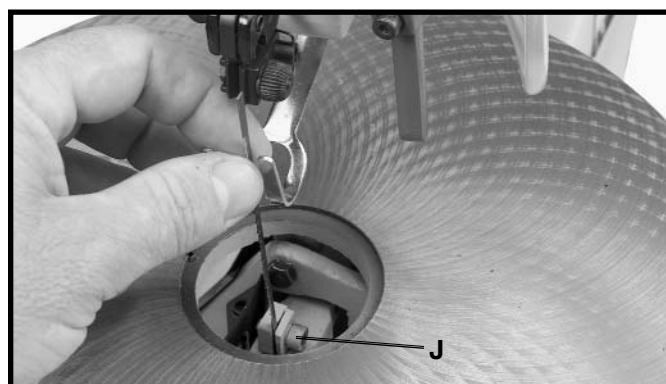

Fig. 26

## ADJUSTING BLADE TENSION

Tension is applied to the blade when the blade tension lever (A) Fig. 27, is in the rear position, as shown. When the lever (A) is moved forward, as shown in Fig. 28, blade tension is released.

When adjusting blade tension, lever (A) should be in the forward position, as shown in Fig. 28. To increase blade tension, turn knob (B) Fig. 28, clockwise and to decrease blade tension, turn knob (B) counterclockwise. **NOTE:** It is necessary to adjust the blade tension knob (B) only when the blade is removed from both upper and lower blade holders and a new or different type of blade is assembled to the holders. It is not necessary to adjust blade tension when the blade is removed and replaced in only the upper blade holder as in performing inside cutting operations.

Adjusting the blade for proper tension is usually accomplished by trial and error. One method is to pull back on the blade tension lever (A) Fig. 28, the blade should start to have tension (resistance) when the blade tension lever is half way between open Fig. 28, and closed Fig. 27. Finer blades require more tensioning while thicker blades require less tension.

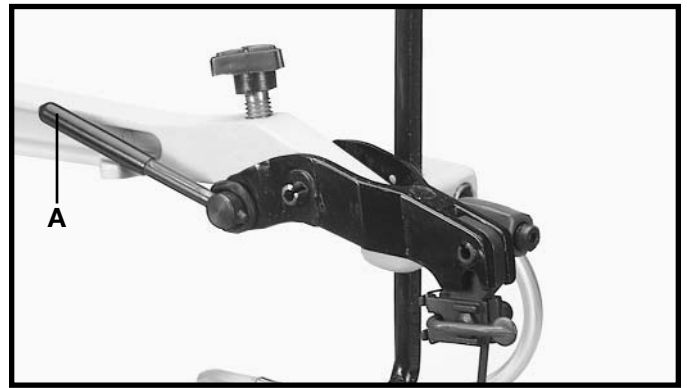

Fig. 27

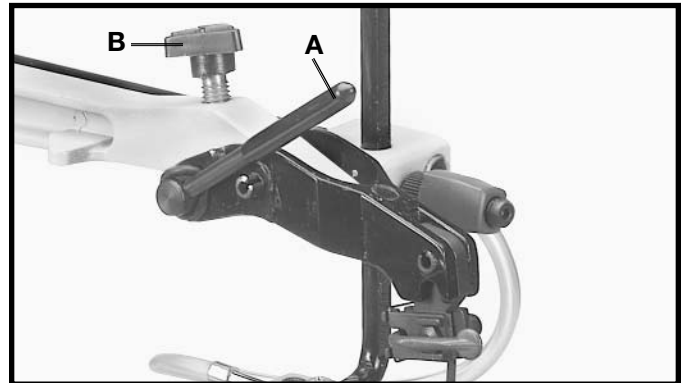

Fig. 28

## ADJUSTING CLAMPING ACTION OF UPPER BLADE HOLDER

Different widths of scroll saw blades will make it necessary to adjust the clamping action of the upper blade holder. It should be noted, however, that very little adjustment is necessary and very little clamping force is required to hold the blade.

1. Move the chuck locking lever (C) Fig. 23, to the rear (open) position, as shown.
2. Turn locknut (C) Fig. 29, clockwise to tighten and counterclockwise to loosen the clamping action of the, blade holder. Very little movement of locknut (C) is necessary.

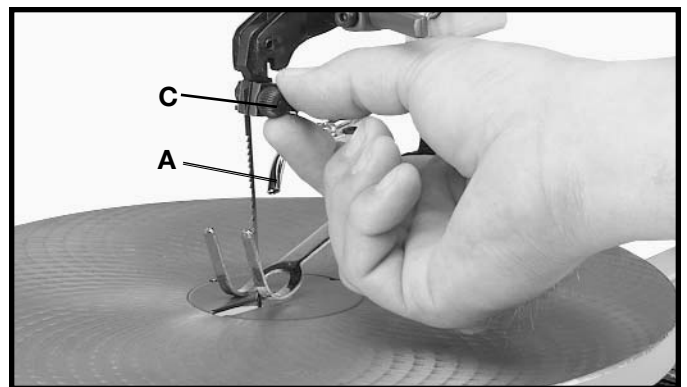

Fig. 29

## TILTING THE TABLE

The table on your scroll saw can be tilted 45 degrees to the left for bevel cutting operations by loosening table lock handle (A) Fig. 30, tilt the table to the desired angle and tighten lock handle (A).

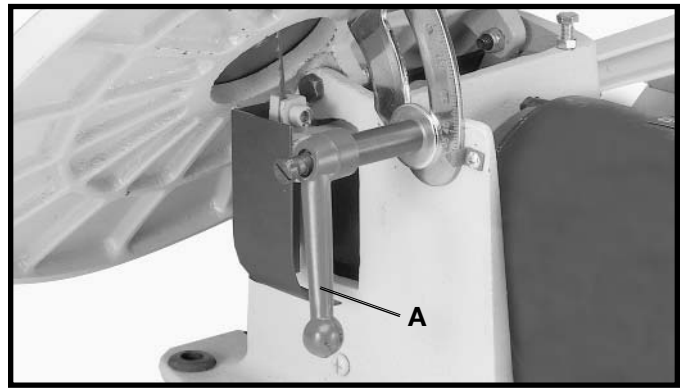

Fig. 30

When bevel cutting, the holddown (B) Fig. 31, can be adjusted to lay flat on the stock by loosening screw (C) and tilting the holddown (B) accordingly. Then tighten screw (C).

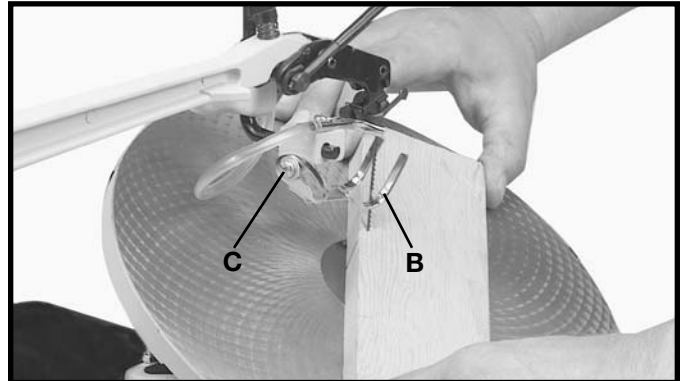

Fig. 31

## ADJUSTING THE TABLE

1. Loosen the table locking handle, and move the table all the way to the right.
2. Using a square (A) Fig. 32, check to see if the table is 90 degrees to the saw blade, as shown.

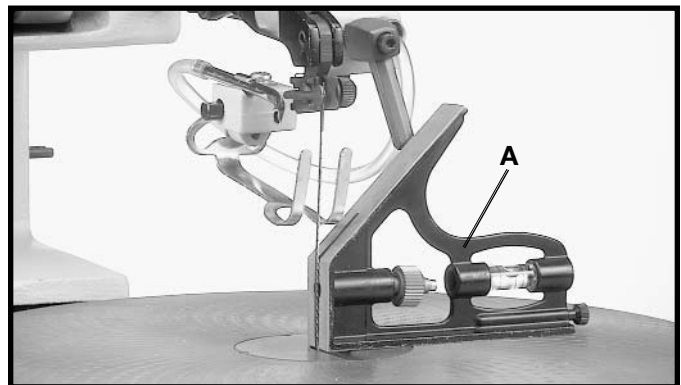

Fig. 32

3. If the table is not at 90 degrees to the blade, adjust the table accordingly making certain screw (B) Fig. 33, contacts bottom of table surface when table is 90 degrees to the blade. Screw (B) can be adjusted by loosening nut (C), thread screw (B) in or out the desired distance and tighten nut (C).

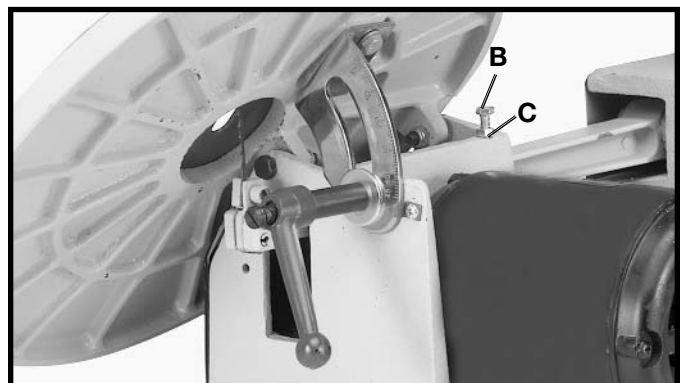

Fig. 33

## ADJUSTING HOLDDOWN

The holddown (A) Fig. 34, should be adjusted so it contacts the top surface of the work being cut by loosening lock handle (B) and moving holddown rod (C) up or down. Then tighten lock handle (B).

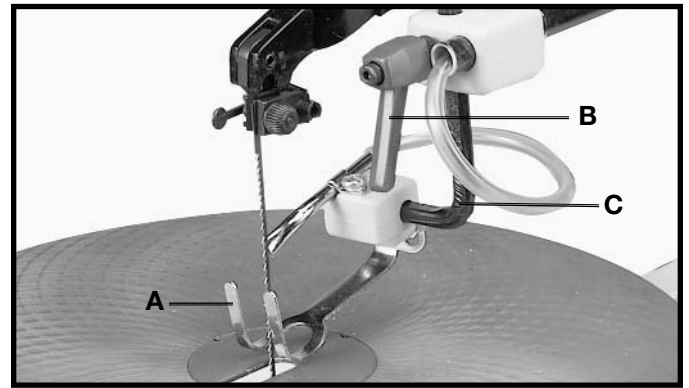

Fig. 34

## ADJUSTING DUST BLOWER

The dust blower (A) Fig. 35, may be moved to direct air to the most effective point on the cutting line by loosening screw (B), adjust nozzle (A), and tighten screw (B).

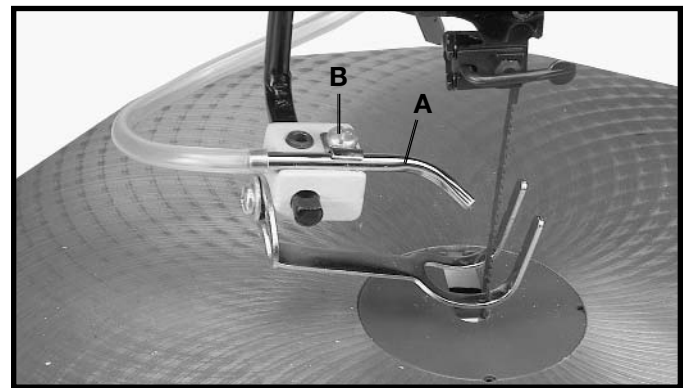

Fig. 35

# FOLLOWING A LINE

With your scroll saw you should be able to cut a straight or curved line with ease. Most beginners will experience blade wandering; however, they eventually learn to control it as they become more familiar with the machine. Use scrap material to practice cuts before starting a project. This enables you to develop your own way of cutting and you will find out what you can and cannot do with your saw.

Always hold the work firmly against the table and do not feed the workpiece too fast while cutting. Feed the workpiece only fast enough so that the blade will cut. Scroll saws cut faster across the grain than they do with the grain. Allow for this tendency when cutting patterns that shift rather quickly from with-the-grain cuts to cross-grain cuts.

Make "relief" cuts before cutting long curves and never attempt to cut a curve that is too tight for the blade being used.

# INSIDE CUTTING

Inside cutting is where the blade must be threaded through a hole in the workpiece. The Delta 16" Scroll Saw has the capability of performing this operation quickly and easily as follows:

Inside cutting can be accomplished quickly with the Delta saw. In Fig. 36, the operator has just completed one of the inside cuts and must move to the next hole.

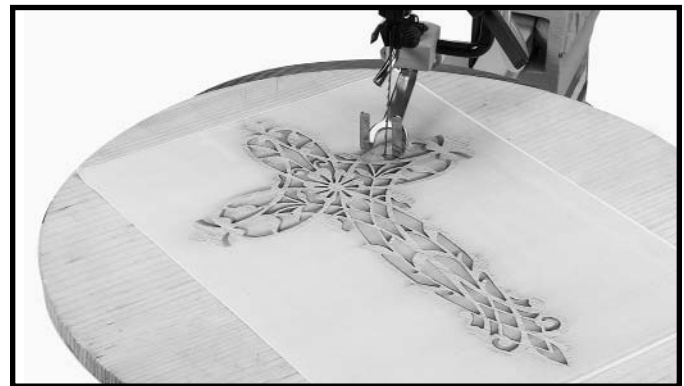

Fig. 36

Loosen lock handle (A) Fig. 37, and raise the spring holddown (B). Release blade tension by moving tension lever (C) forward and loosen upper blade holder by moving lever (D) to the rear as shown. This will release the blade (E). Insert the blade (E) into the next hole in the pattern, as shown.

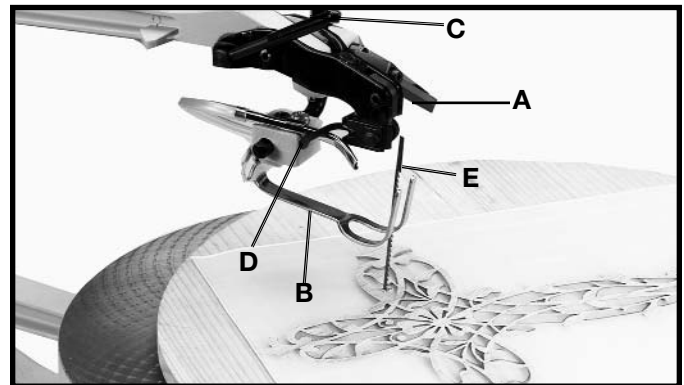

Fig. 37

Place blade (E) Fig. 38, back into the upper blade holder and tighten blade by moving lever (D) forward. Move tension lever (C) to the rear and lower spring holddown (B). You are ready to make the next inside cut.

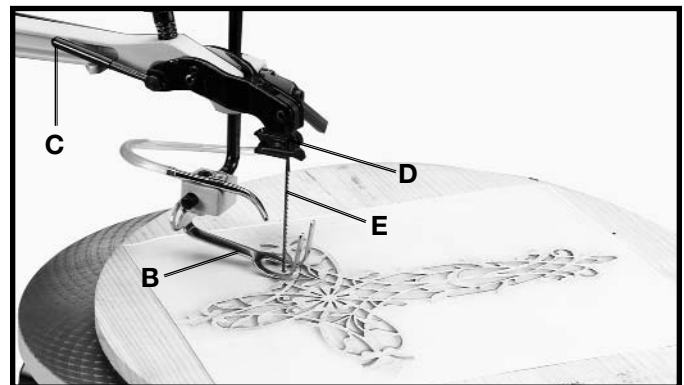

Fig. 38



# LUBRICATION

Delta recommends that the scroll saw be oiled after each 20 hours of use, as follows:

1. **DISCONNECT MACHINE FROM POWER SOURCE.**
2. Remove four screws (A) Fig. 39, and remove side panel (B) from the scroll saw.
3. Release blade tension by pulling tension lever (C) Fig. 40, forward as shown.
4. Lubricate the shafts of two special screws (D) Fig. 41, with a few drops of light machine oil in the areas where they pass through the connecting link (E). **NOTE: DO NOT REMOVE SPECIAL SCREWS TO LUBRICATE.**
5. Remove two pivot bolts (F) Fig. 42.
6. Thoroughly clean grease from shafts (G) Fig. 42, of both pivot bolts (F) and lubricate shafts (G) with a few drops of light machine oil.
7. Reassemble two pivot bolts (F) Fig. 42, to machine.
8. Replace side panel removed in STEP 2 and reapply tension to the blade.

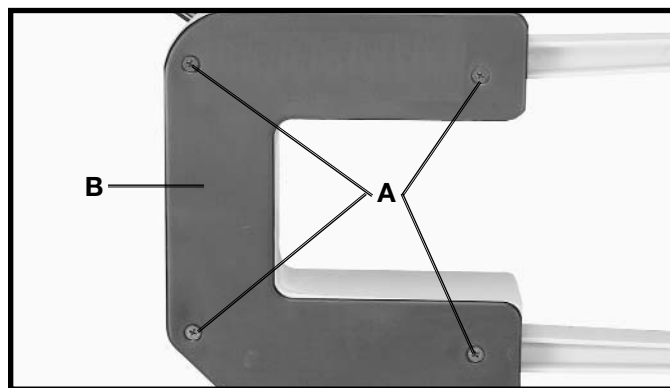

Fig. 39



Fig. 40

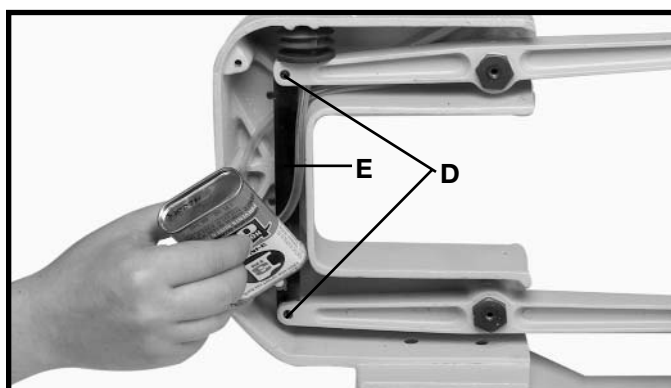

Fig. 41

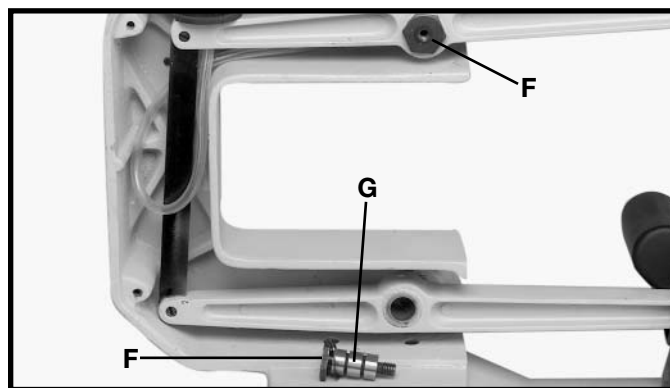

Fig. 42

## CHOICE OF BLADE AND SPEED

Your scroll saw will accept a wide variety of 5" flat end blades and can be operated at any speed from 400 to 1800 cutting strokes per minute. Consider the following as a general guideline for selecting a blade and operating speed.

1. Use a finer blade for cutting thin workpieces, for hard materials, or when a smoother cut is required.
2. Use a coarser blade for cutting thick workpieces, when making straight cuts or for medium to soft materials.
3. Use a blade that will have 2 teeth in the workpiece at all times.
4. Most blade packaging is marked with the size of the wood the blade is intended to cut and the minimum radius which can be cut with that blade.
5. Slower speeds are generally more effective than faster speeds when using thin blades and making intricate cuts.
6. Always start at a slow speed and gradually increase the speed until the optimum cutting speed is obtained.

## BLADE BREAKAGE

Blade breakage is usually caused by one or more of the following:

1. Bending the blade during installation.
2. Improper blade tension.
3. Improper blade selection for the work being cut.
4. Forcing the work into the blade too rapidly.
5. Cutting too sharp a turn for the blade being used.
6. Improper blade speed.

# NOTES

# NOTES

# ACCESSORIES

A complete line of accessories is available from your Delta Supplier, Porter-Cable • Delta Factory Service Centers, and Delta Authorized Service Stations. Please visit our Web Site [www.deltamachinery.com](http://www.deltamachinery.com) for a catalog or for the name of your nearest supplier.



**WARNING:** Since accessories other than those offered by Delta have not been tested with this product, use of such accessories could be hazardous. For safest operation, only Delta recommended accessories should be used with this product.



## PARTS, SERVICE OR WARRANTY ASSISTANCE

All Delta Machines and accessories are manufactured to high quality standards and are serviced by a network of Porter-Cable • Delta Factory Service Centers and Delta Authorized Service Stations. To obtain additional information regarding your Delta quality product or to obtain parts, service, warranty assistance, or the location of the nearest service outlet, please call 1-800-223-7278 (In Canada call 1-800-463-3582).



### Two Year Limited Warranty

Delta will repair or replace, at its expense and at its option, any Delta machine, machine part, or machine accessory which in normal use has proven to be defective in workmanship or material, provided that the customer returns the product prepaid to a Delta factory service center or authorized service station with proof of purchase of the product within two years and provides Delta with reasonable opportunity to verify the alleged defect by inspection. Delta may require that electric motors be returned prepaid to a motor manufacturer's authorized station for inspection and repair or replacement. Delta will not be responsible for any asserted defect which has resulted from normal wear, misuse, abuse or repair or alteration made or specifically authorized by anyone other than an authorized Delta service facility or representative. Under no circumstances will Delta be liable for incidental or consequential damages resulting from defective products. This warranty is Delta's sole warranty and sets forth the customer's exclusive remedy, with respect to defective products; all other warranties, express or implied, whether of merchantability, fitness for purpose, or otherwise, are expressly disclaimed by Delta.

Printed in U.S.A.

## Free Manuals Download Website

<http://myh66.com>

<http://usermanuals.us>

<http://www.somanuals.com>

<http://www.4manuals.cc>

<http://www.manual-lib.com>

<http://www.404manual.com>

<http://www.luxmanual.com>

<http://aubethermostatmanual.com>

Golf course search by state

<http://golfingnear.com>

Email search by domain

<http://emailbydomain.com>

Auto manuals search

<http://auto.somanuals.com>

TV manuals search

<http://tv.somanuals.com>