

ASSEMBLY
OPERATION
REPLACEMENT PARTS

Demco

Doing Our Best to Provide You the Best

BOLT TORQUE SPECIFICATIONS

STANDARD BOLTS:

Size	Grade	Torque
5/16"	5	20 ft/lbs.
3/8"	5	35 ft/lbs.
7/16"	5	56 ft/lbs.
1/2"	5	85 ft/lbs.

METRIC BOLTS:

Size	Torque
8mm	22 ft/lbs.
10mm	42 ft/lbs.
12mm	70 ft/lbs.
14mm	95 ft/lbs.

READ complete manual CAREFULLY
BEFORE attempting operation.

Pin Height - 14-3/4" Center - 24"

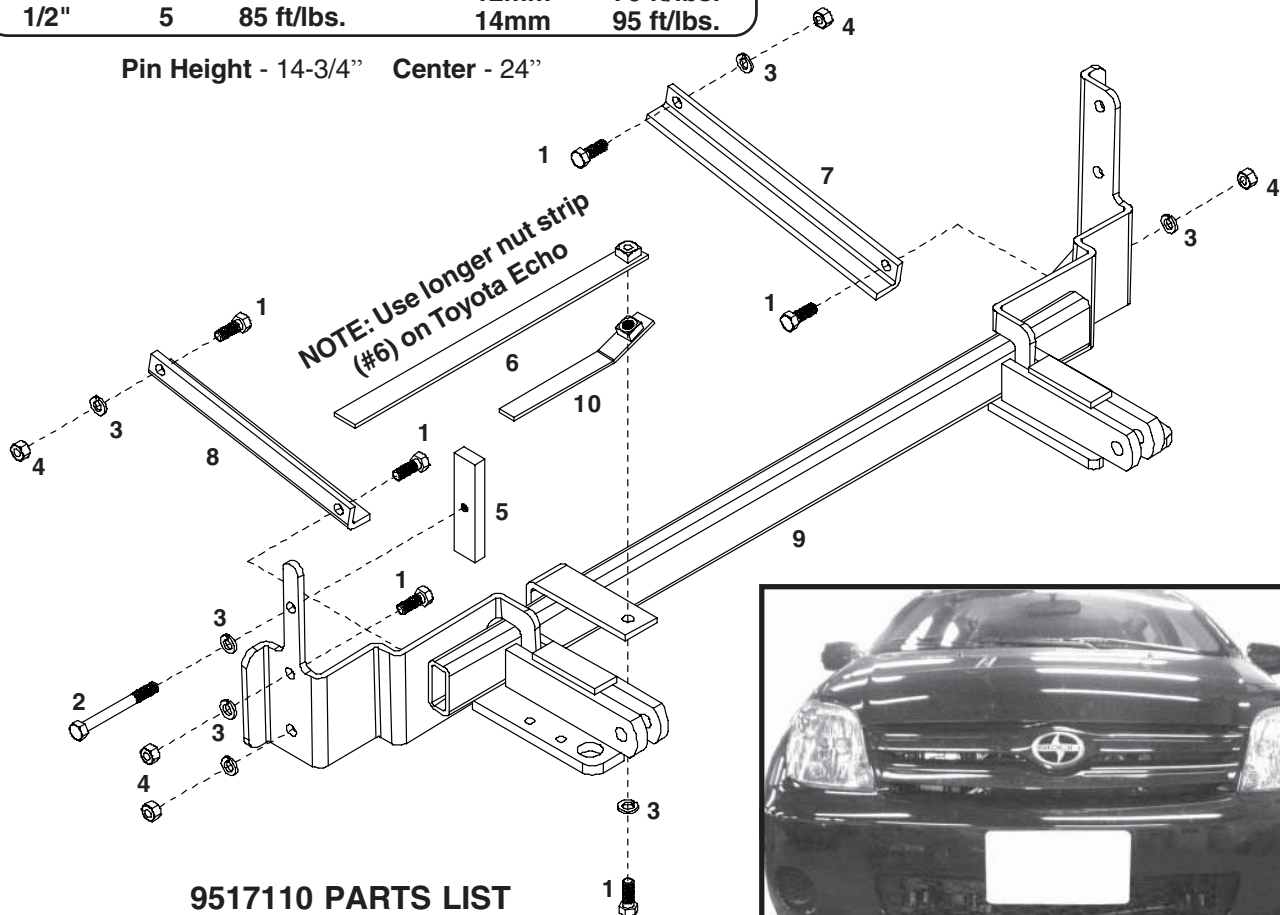

9517110 PARTS LIST

REF. NO.	PART NO.	QTY.	DESCRIPTION
1.	00907	6	3/8"-16UNC x 1" Hex Bolt Gr.5
2.	01903	1	3/8"-16UNC x 3-1/2" Hex Bolt Gr.5
3.	00060	7	3/8" Lock washer
4.	00061	5	3/8"-16UNC Hex Nut
5.	10565-95	1	Thread Plate
6.	10382-35	1	Long Nut Strip
7.	10563-35	1	Left Base Brace Bracket
8.	10564-35	1	Right Base Brace Bracket
9.	10562-35	1	Baseplate Crossmember
10.	11251-35	1	Short nut strip
11.	12329	1	Loctite(not shown)

Please order replacement parts by PART NO. and DESCRIPTION.



DEMCO • Dethmers Mfg. Co. • 4010 320th Street • P.O. Box 189 • Boyden, IA 51234
PH: (712) 725-2311 • Toll Free: 1-800-543-3626 • FAX: (712) 725-2380 or 1-800-845-6420
www.demco-products.com

DEMCO PRODUCTS ORIGINAL PURCHASERS LIMITED WARRANTY

1. Extent and Duration of this Warranty:

Your Demco product has a Lifetime Limited warranty to be free from defects in materials and workmanship under normal use and service from date of purchase by the original (first) retail owner, or until it is resold or transferred by the original owner. Any part of the Demco product found in the judgement of the manufacturer to be defective in materials or workmanship will be repaired or replaced at the manufacturer's option without charge for parts or labor to the original owner.

2. Manufacturer and Warrantor:

Dethmers Manufacturing Co.
4010 320th Street
P.O. Box 189
Boyden, IA 51234
(712) 725-2311

3. Repair or Replacement Procedure:

If your Demco product develops a defect during the warranty period, promptly notify Dethmers Manufacturing Co. customer service department. Until such notice is received, Warrantor will not be responsible for any repair or replacement.

Upon receipt of notice from you, Warrantor will have a choice of options in replacing any part it determines to be defective:

- a) Warrantor may require you at your own expense to deliver or ship the part to its factory or authorized dealer. Any defective part will be repaired or replaced and returned to you free of charge. Any part returned to Warrantor and found not to be defective will be returned to you freight collect with an explanation.
- b) Warrantor may elect to ship a new part to its dealer to be exchanged free of charge for the defective part returned by you to the dealer.
- c) Warrantor may elect to ship or deliver a replacement part to your address.

4. Limitations on Warranty Coverage:

Coverage under this warranty will be valid only if the customer warranty card is returned by the original purchaser within 30 days of purchase.

Coverage under this warranty will be effective only when a copy of the original invoice, showing the date and location of purchase, accompanies any claim for warranty. This warranty is limited to the original owner and is **NON TRANSFERABLE** to a second party.

Warrantor has no liability whatsoever and this warranty is null and void if any Demco product has been misassembled or subjected to neglect, negligence, misuse, accident or operated in any way contrary to the operating and maintenance instructions as specified in the Demco Owner's Manual for that model.

This warranty does not cover any product that has been altered or modified so as to affect its operation, performance or durability, or that has been modified to change the intended use of the product.

In addition, the warranty does not extend to repairs made necessary by normal use of parts, accessories or other equipment which in the judgment of Warrantor, are either incompatible with the Demco product, or affect its operation, performance or durability.

This warranty does not cover:

- 1) normal wear and tear
- 2) road film or gravel damage to paint
- 3) paint
- 4) rust damage

Warrantor has a policy of continuous product improvement. We reserve the right to change or improve the design of any Demco product, including but not limited to state of the art changes, without assuming any obligation to modify any product previously manufactured.

Warrantor assumes no responsibility to the owner for loss of use of the product, loss of time, inconvenience or other damage consequential or otherwise, including, but not limited to expense for gasoline, expense of transporting the product to the dealer and expense of returning the product, mechanic's travel time, telephone or telegram charges, road service/towing charges, rental of another product during the time warranty repairs are being performed, travel, lodging, loss or damage to personal property or loss of revenue or earnings.

5. Limitations of Implied Warranties:

All implied warranties, if any, expire and terminate upon expiration of this warranty. Some states do not allow limitation on how long an implied warranty lasts, so this limitation may not apply to you.

6. Limitation of Consequential Damages:

Warrantor's responsibility under this warranty extends solely to repair or replacement of your Demco product and its component parts.

Warrantor does not assume responsibility for, nor shall it be liable for, any special, incidental or consequential damages. Some states do not allow the exclusion or limitation on incidental or consequential damages, so the above exclusion or limitation may not apply to you.

7. Purchaser's Rights:

This warranty gives you specific legal rights, and you may also have other rights which vary from state to state.

8. Exclusive Warranty:

This is the only express warranty made by Dethmers Manufacturing Co. on your Demco product and no agent, employee, or other person is allowed to change or add to this warranty.

WARNING: FAILURE TO FOLLOW THESE INSTRUCTIONS CAN RESULT IN LOSS OF TOWING VEHICLE CONTROL, SEPARATION OF THE TOW BAR FROM THE TOWING VEHICLE, SEPARATION OF THE TOWED VEHICLE FROM THE TOW BAR, CAUSING SEVERE PERSONAL INJURY, DEATH, OR PROPERTY DAMAGE.

CAUTION

Safety is of utmost importance at all times. There are several items that must be checked each time before using and while using a tow bar. Before allowing anyone to hook up or operate a tow bar, be sure they have read and understand the proper operating procedure.

DO NOT use worn or damaged cables and/or pins.

Be sure the **SAFETY CABLES** are hooked, chassis to chassis, to both the towing and towed vehicles using the crisscross method.

Check clearance between vehicles in a turning situation.

Check base plate mounting bolts for tightness and frame for metal fatigue.

Do not load the towed vehicle with anything as you may exceed the towing capacity of the tow bar.

Keep fingers away from pivot points to prevent personal injury.

Be sure the steering components of the towed vehicle are properly aligned.

NOTE: This unit can be backed up in moderate increments. Any severe backwards cornering could result in damage to the Tow Bar and/or towed vehicle chassis.

For automatic transmissions: Consult your vehicle owners manual for towing suitability with the drive shaft connected. Otherwise, the towed vehicle will have to be equipped with a transmission pump or drive shaft disconnect.

Check to make sure that all lights are in proper working order.

The information on towability of vehicles is reprinted with permission of MotorHome® Magazine, and is believed to be reliable. However, Demco does not warrant the information to be correct. Always consult your towed vehicle owner's manual and follow towing instructions. Each year, MotorHome® Magazine, compiles a list of vehicles that can be towed four-down behind a motorhome with no modifications required. This guide contains only those vehicles that have been approved by their manufacturers for towing. This list is enclosed with this manual.

 **Caution: MotorHome® Magazine** left out any vehicles that have towing speed limits slower than 55 m.p.h., or distance limits of less than 200 miles. At a minimum, these vehicles require significant modification, such as the use of an aftermarket product, to make them towable. The availability of a **Demco Tow Bar Base Plate** does not imply that these vehicles can be modified or that there is an aftermarket product available. Refer to your vehicle owner's manual or consult your dealer to determine whether your vehicle can be modified to make it towable. Failure to observe this precaution could result in property damage or personal injury.

IMPORTANT INSTALLATION ITEMS

DEMCO products and accessories are intended to be installed by professional installers with experience, proper equipment and the ability to do modification work. Installers with these qualifications can be found in RV and Automotive Service Centers.

If the car to be towed has been in an accident, the chassis may be damaged in an area where the Base Plate attaches. It may no longer be suitable for towing. Extreme caution and careful examination are required in such a situation. It is also likely, even from a minor accident, that the hole alignment will be more difficult due to hole alignment problems.

Many DEMCO Base Plates are designed to use existing holes and hardware to mount the Base Plate to the towed vehicle. Even though the bolt is there, however, do not assume it is adequate for mounting the Base Plate. Manufacturers make many changes in hardware both within and between model years. Be sure the bolt is long enough to protrude past the nut a distance no less than 1/2 the diameter of the bolt, after the Base Plate is mounted. The threads should be in good condition. **We require that "LOCTITE® Blue" be used on all bolts.** If a new bolt is required, be sure it is SAE Grade 5 or Metric 8.8.

NOTE: The dimensional variations between otherwise identical vehicles can be considerable. Some minor modifications may have to be made to ensure a proper fit.

INSTALLATION INSTRUCTIONS

TOYOTA ECHO

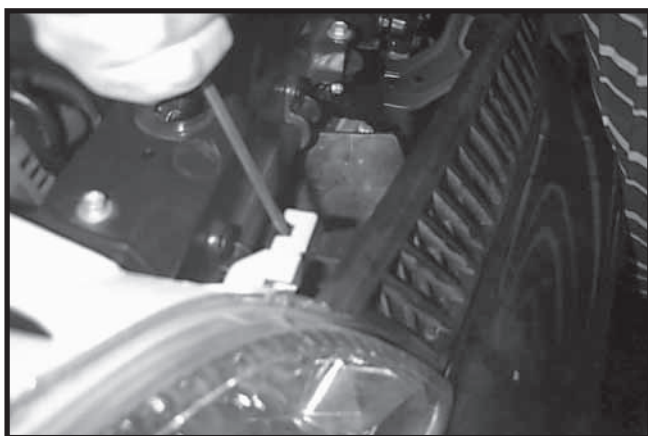

1. Open hood and remove center grill, one plastic push fastener and remove the four tabs and remove.

SCION XA



1. Open hood and remove center grill, four plastic push fasteners and remove.

TOYOTA ECHO

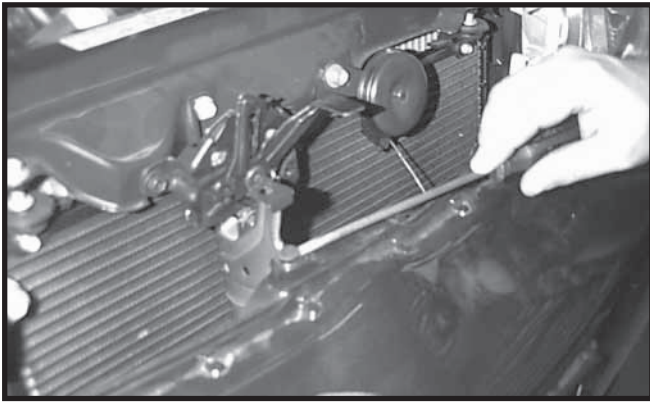

2. Remove one plastic push fastener on top of fascia.

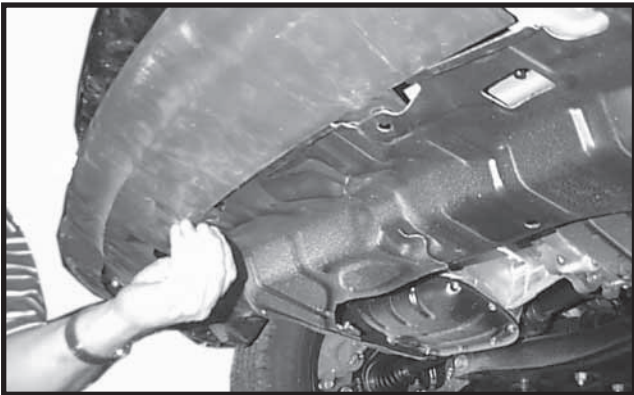

3. Remove fasteners from front of belly pan to bottom of fascia.

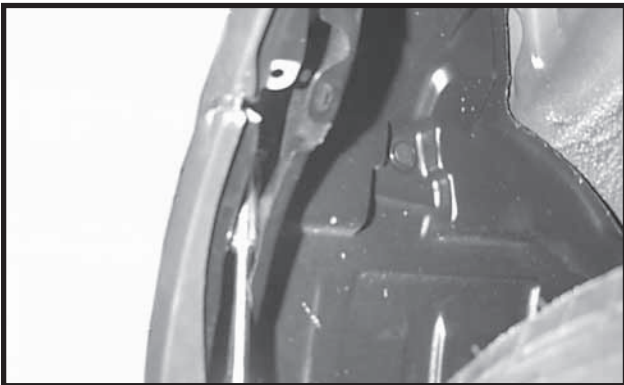

4. Remove one screw from fascia to fender on each side and carefully remove fascia.

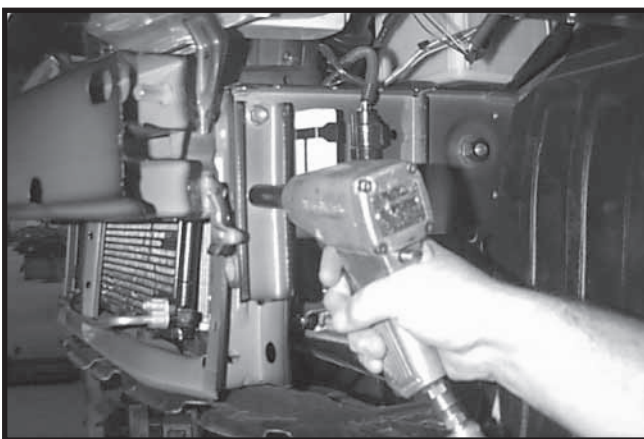

5. On driver's side, remove two bolts holding tow eye bracket, these bolts will be reused, bracket will not.

SCION XA

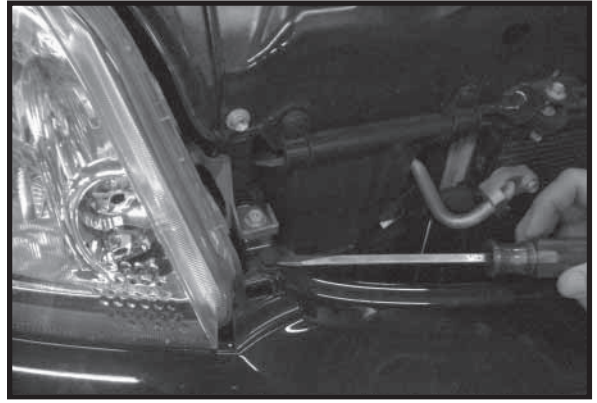

2. Remove three plastic push fasteners on top of fascia.



3. Remove eight fasteners from front of belly pan to bottom of fascia

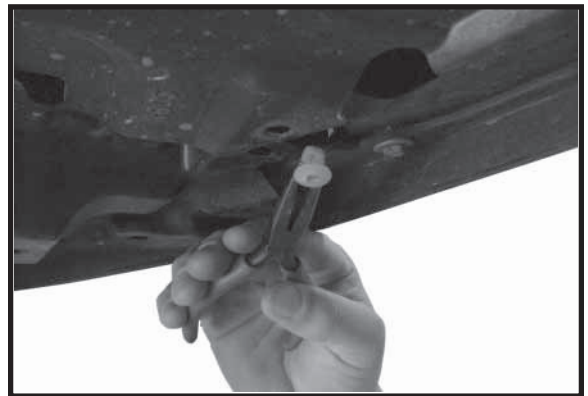

4. Remove two plastic screw holders from bottom of fascia. Unplug fog lights and clearance lights if equipped.



5. Remove one screw from fascia to fender on each side.

TOYOTA ECHO

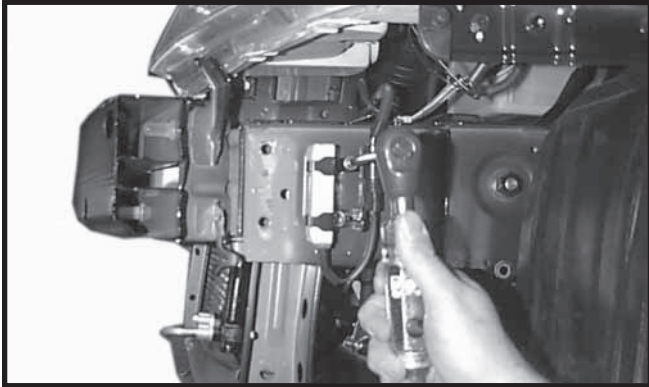

6. Temporarily remove two screws from ceramic box and let hang.

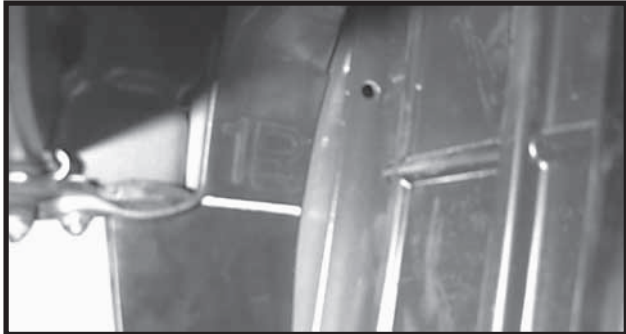

7. Cut plastic side shields even with bottom of bumper on each side.

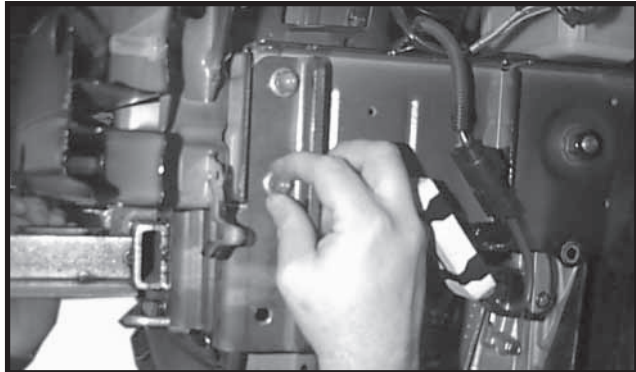

8. Slide baseplate up from bottom. On driver's side, start two bolts that were removed from tow eye bracket.

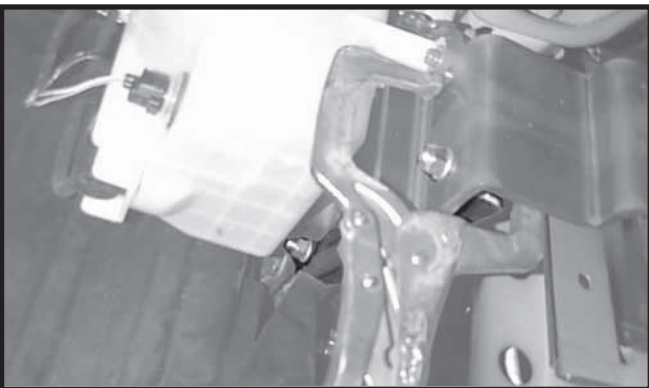

9. On passenger's side, push baseplate up and temporarily clamp in place. Now install short rear brace on passenger's side and long rear brace on driver's side, using four 3/8" x 1" bolts, four 3/8" lock washers, and four 3/8" hex nuts. **NOTE:** Braces attach to bottom hole in baseplate and frame hole hanging from frame. Use " **LOCTITE** " blue on all bolts. Do not tighten yet.

SCION XA



6. Pull fascia out at wheel wells and carefully remove fascia.

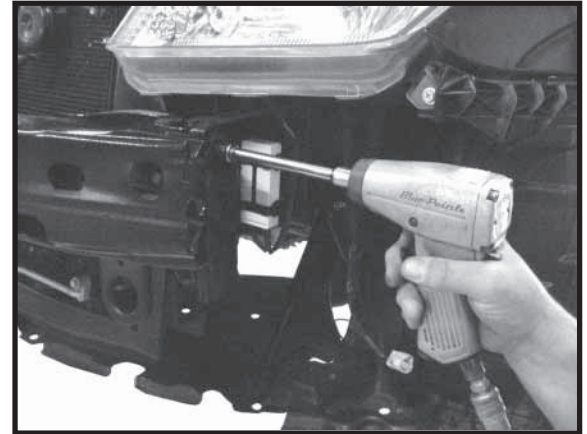

7. On driver's side, remove two bolts holding tow eye bracket, these bolts will be reused, bracket will not. Also, temporarily remove two screws from ceramic box and let hang.

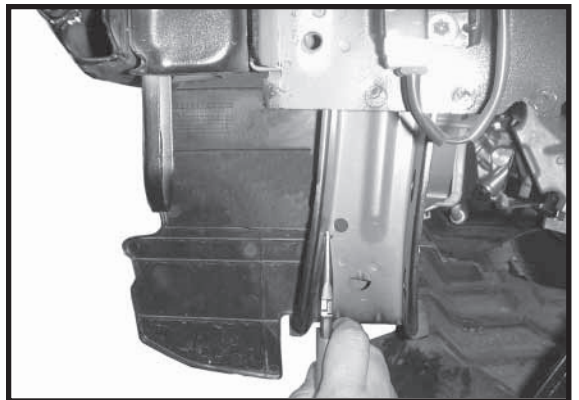

8. Remove plastic side shields and set aside for later reinstallation.

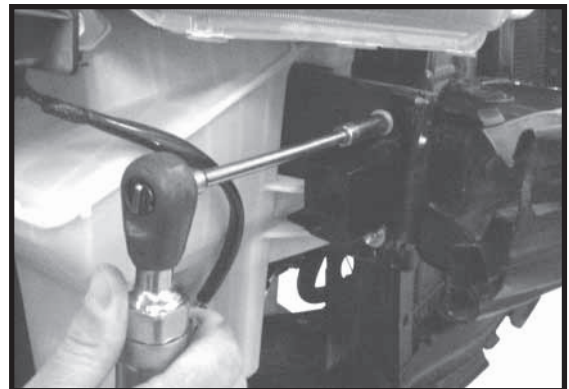

9. Remove counter balance weight.

TOYOTA ECHO

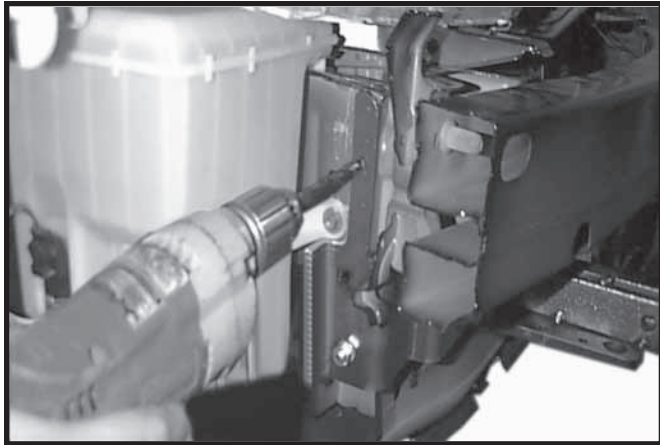

10. On passenger's side, drill top hole of baseplate using 3/8" drill bit, using baseplate hole as template. This hole must line up with hole on inside of box frame.

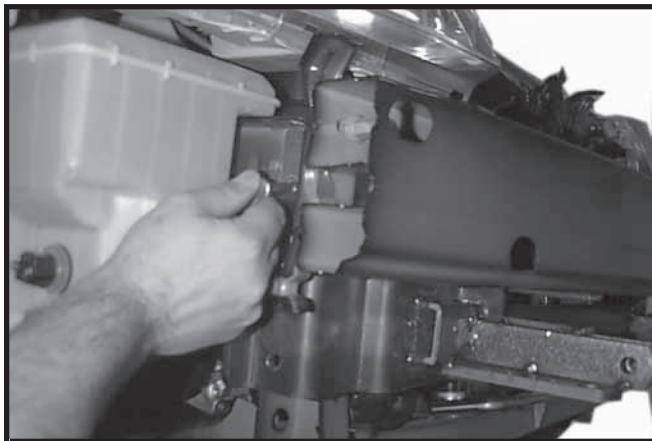

11. Install 3/8" x 3-1/2" bolt, 3/8" lock washer, and install through base plate frame, and thread into threaded nut plate on inside of frame. Do not tighten yet.

SCION XA

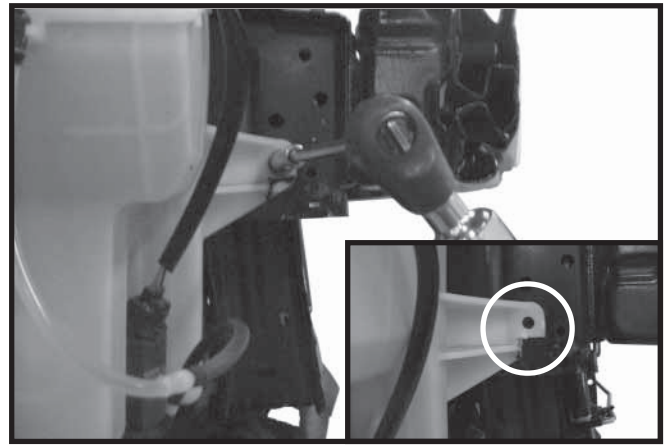

10. Remove one bolt in washer tank (washer tank bracket will need to be notched for clearance of baseplate).

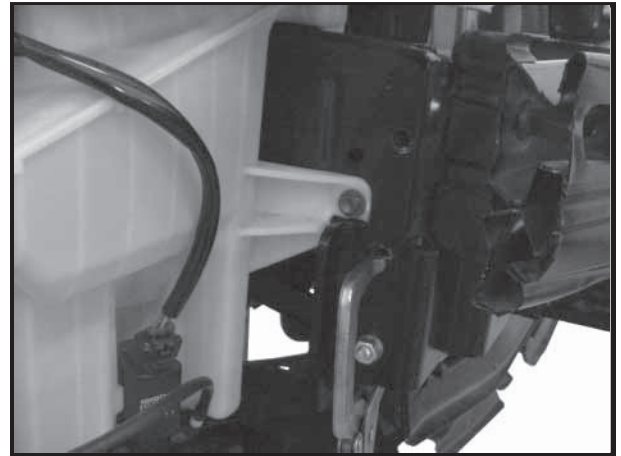

11. On passenger's side, push baseplate up and temporary clamp in place. Now install short rear brace on passenger's side and long rear brace on driver's side, using four 3/8" x 1" bolts, four 3/8" lock washers, and four 3/8" hex nuts. **NOTE:** Braces attach to bottom hole in baseplate and frame hole hanging from frame. Use "**LOCTITE**" "blue on all bolts. Do not tighten yet.

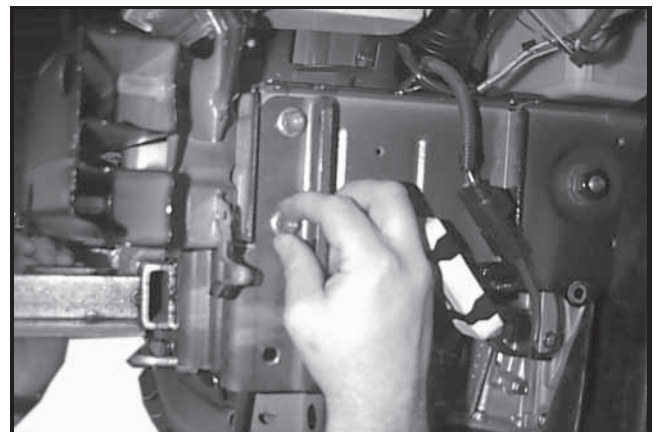

12. Slide baseplate up from bottom. On driver's side, start two bolts that were removed from tow eye bracket.

TOYOTA ECHO

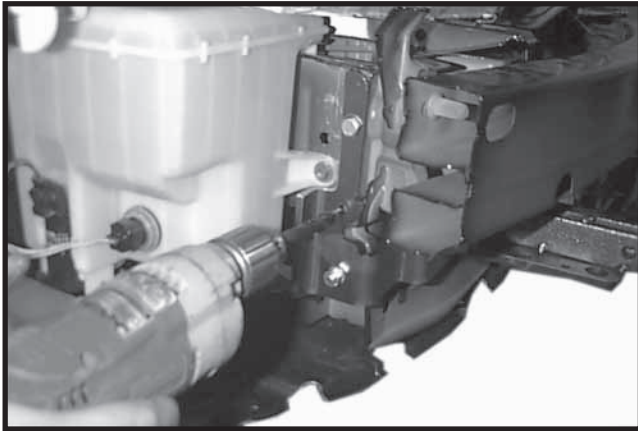

12. Next, drill 3/8" hole, using baseplate as template, through flange on vehicle. Install 3/8" x 1" bolt, 3/8" lock washer, and 3/8" hex nut through drilled hole. Tighten all bolts before proceeding. **NOTE:** Use bolt torque chart on front.

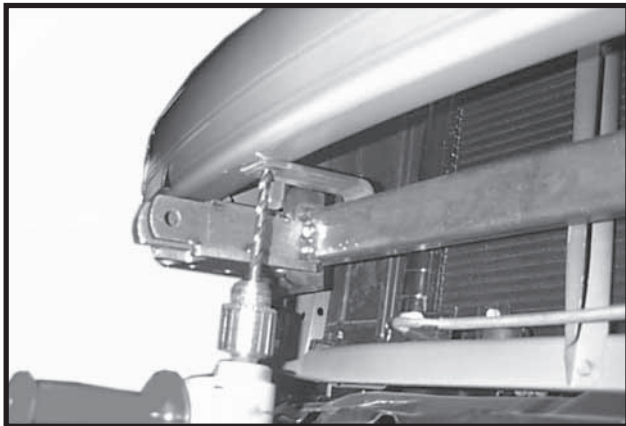

13. Drill 3/8" hole through bottom of bumper, using baseplate as template. This is located under bumper on passenger's side.

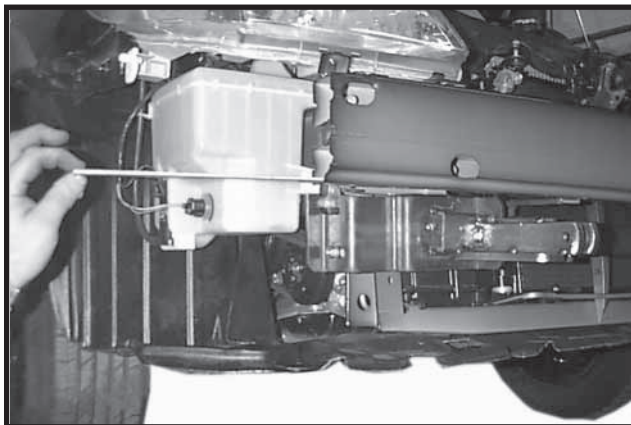

14. Slide long nut strip into end of bumper and use 3/8" x 1" bolt and 3/8" lock washer and tighten bolt.

15. Reinstall ceramic box on driver's side.

SCION XA

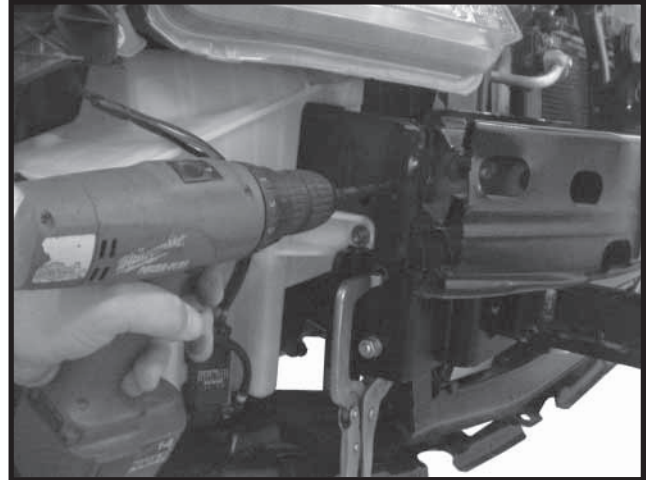

13. On passenger's side, drill top hole of baseplate using 3/8" drill bit, using baseplate hole as template. This hole must line up with hole on inside of box frame.

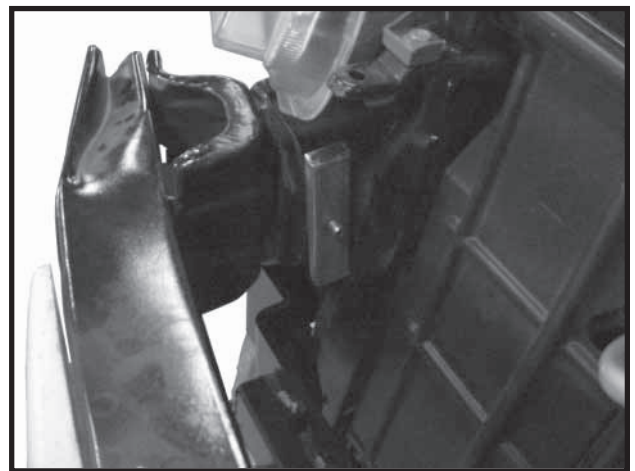

14. Install 3/8" x 3-1/2" bolt, 3/8" lock washer, and install through base plate frame, and thread into threaded nut plate on inside of frame. Do not tighten yet.

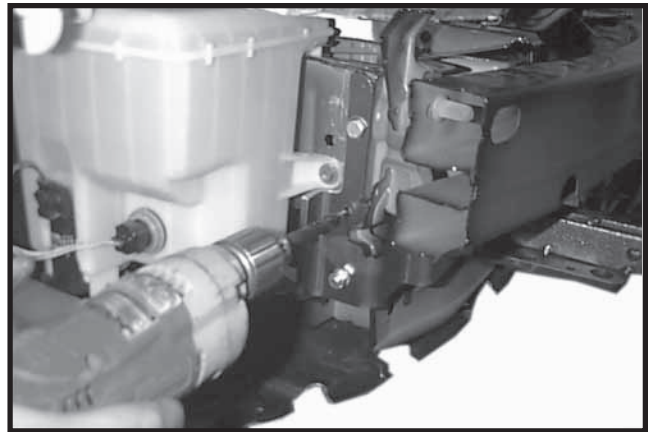

15. Next, drill 3/8" hole, using baseplate as template, through flange on vehicle. Install 3/8" x 1" bolt, 3/8" lock washer, and 3/8" hex nut through drilled hole. Tighten all bolts before proceeding. **NOTE:** Use bolt torque chart on front.

TOYOTA ECHO

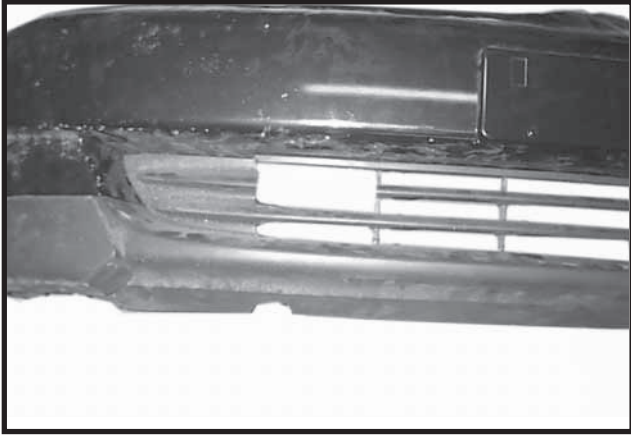

16. Cut fascia crossbar out according to picture on each side.

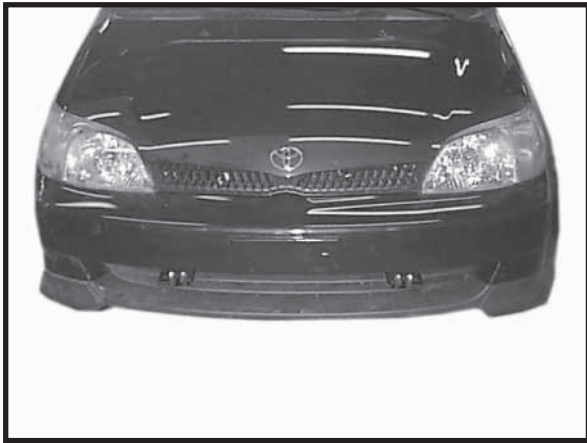

17. Reinstall fascia and hardware.

SCION XA

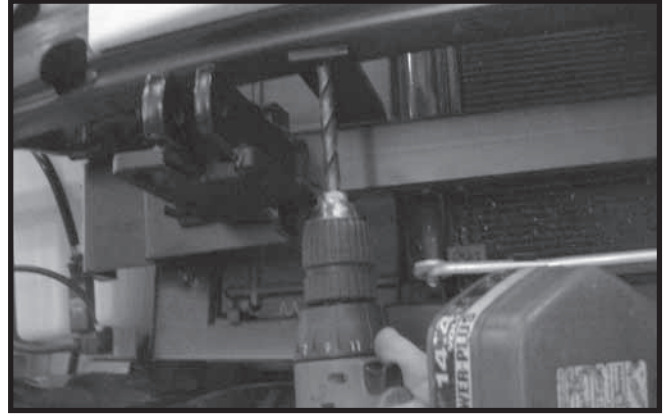

16. Drill 3/8" hole through bottom of bumper, using base-plate as template. This is located under bumper on passenger's side.



17. Slide short nut strip into hole in bumper and use 3/8" x 1" bolt and 3/8" lock washer and tighten bolt.

18. Reinstall ceramic box on driver's side.

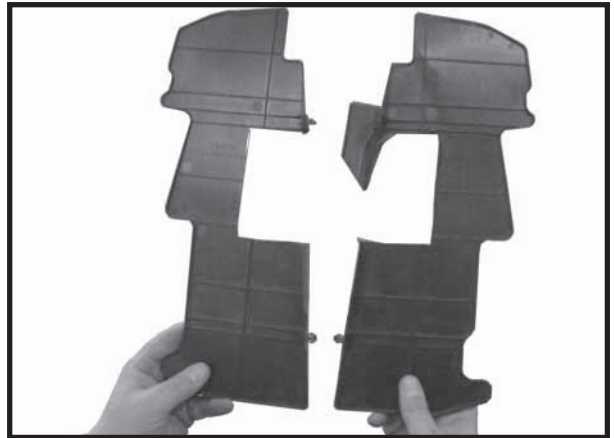

19. Notch plastic shields and reinstall.

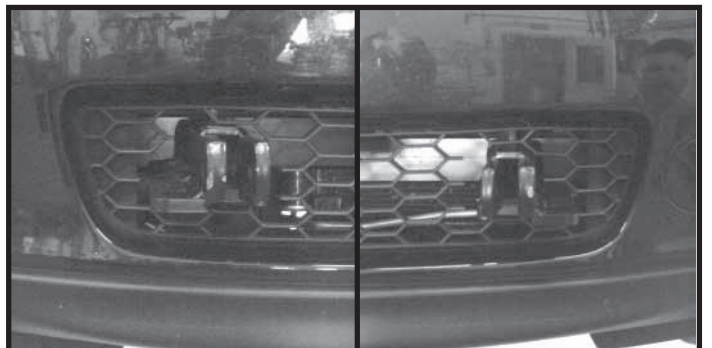

20. Cut fascia according to picture on each side. Reinstall fascia and hardware.



Warranty Registration

Dethmers Manufacturing Company
 4010 320th Street • Box 189 • Boyden, Iowa 51234
 Toll Free 800-54DEMCO (800-543-3626) • FAX 800-845-6420
 www.demco-products.com

Ag	<input type="radio"/>
RV	<input type="radio"/>
Rental	<input type="radio"/>
Brakes	<input type="radio"/>
Marine	<input type="radio"/>

	Very Satisfied	Satisfied	Dissatisfied	Very Dissatisfied
How satisfied are you with our product?	<input type="radio"/>	<input type="radio"/>	<input type="radio"/>	<input type="radio"/>
How satisfied are you with the dealership/distributor sales staff?	<input type="radio"/>	<input type="radio"/>	<input type="radio"/>	<input type="radio"/>
Dealer/Distributor Name _____ City _____ State _____				
How satisfied are you with the company sales staff?	<input type="radio"/>	<input type="radio"/>	<input type="radio"/>	<input type="radio"/>
How satisfied are you with the delivery?	<input type="radio"/>	<input type="radio"/>	<input type="radio"/>	<input type="radio"/>
Did you have any contact with a Demco Representative?	YES	NO		
If YES , how satisfied were you?	<input type="radio"/>	<input type="radio"/>	<input type="radio"/>	<input type="radio"/>
I would recommend this product to my family and friends.	YES	NO		
Would you purchase again from DEMCO?	YES	NO		
Since taking delivery, have you been contacted by the dealer?	YES	NO		
Did you have any problems with this DEMCO product?	YES	NO		
If YES , are you satisfied with the company's resolution of your problem?	<input type="radio"/>	<input type="radio"/>	<input type="radio"/>	<input type="radio"/>

Why did you purchase this product? _____

Please list the specific source of information prompting this purchase.

After purchasing this product, do you see any needed product improvement? _____ If yes, what improvement? _____

What other products would you like to see DEMCO offer? _____

Comments _____

Owner's Name: _____ Mailing Address: _____

City: _____ State: _____ Zip Code: _____

Model#: _____

Serial #: _____

Purchase Date: _____

Owner's Signature: _____

Please return to DETHMERS MFG. CO. By FAX or tri-folding this form to the backside, it is pre-addressed.

Postage

*Dethmers Manufacturing Company
4010 320th Street, Box 189
Boyden, Iowa 51234*

NOTES

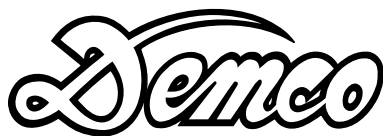

DETHMERS MFG. COMPANY

P.O. BOX 189 4010 320th St.,

BOYDEN, IA. 51234 PH: (712) 725-2311

FAX: (712) 725-2380 or 1-800-845-6420

TOLL FREE: 1-800-54DEMCO (1-800-543-3626)

www.demco-products.com

Free Manuals Download Website

<http://myh66.com>

<http://usermanuals.us>

<http://www.somanuals.com>

<http://www.4manuals.cc>

<http://www.manual-lib.com>

<http://www.404manual.com>

<http://www.luxmanual.com>

<http://aubethermostatmanual.com>

Golf course search by state

<http://golfingnear.com>

Email search by domain

<http://emailbydomain.com>

Auto manuals search

<http://auto.somanuals.com>

TV manuals search

<http://tv.somanuals.com>