

DENON

CD RECEIVER

RCD-M38

Owner's Manual

Manuel de l'Utilisateur

Manual del usuario

☐ SAFETY PRECAUTIONS



CAUTION
RISK OF ELECTRIC SHOCK
DO NOT OPEN



CAUTION:
TO REDUCE THE RISK OF ELECTRIC SHOCK, DO NOT REMOVE COVER (OR BACK). NO USER-SERVICEABLE PARTS INSIDE. REFER SERVICING TO QUALIFIED SERVICE PERSONNEL.

The lightning flash with arrowhead symbol, within an equilateral triangle, is intended to alert the user to the presence of uninsulated "dangerous voltage" within the product's enclosure that may be of sufficient magnitude to constitute a risk of electric shock to persons.

The exclamation point within an equilateral triangle is intended to alert the user to the presence of important operating and maintenance (servicing) instructions in the literature accompanying the appliance.

WARNING:
TO REDUCE THE RISK OF FIRE OR ELECTRIC SHOCK, DO NOT EXPOSE THIS APPLIANCE TO RAIN OR MOISTURE.

CAUTION:
USE OF CONTROLS OR ADJUSTMENTS OR PERFORMANCE OF PROCEDURES OTHER THAN THOSE SPECIFIED HEREIN MAY RESULT IN HAZARDOUS RADIATION EXPOSURE. THIS PRODUCT SHOULD NOT BE ADJUSTED OR REPAIRED BY ANYONE EXCEPT PROPERLY QUALIFIED SERVICE PERSONNEL.

☐ Laser Class (IEC 60825-1:2001)

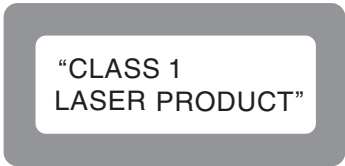

IMPORTANT SAFETY INSTRUCTIONS

1. Read these instructions.
2. Keep these instructions.
3. Heed all warnings.
4. Follow all instructions.
5. Do not use this apparatus near water.
6. Clean only with dry cloth.
7. Do not block any ventilation openings.
Install in accordance with the manufacturer's instructions.
8. Do not install near any heat sources such as radiators, heat registers, stoves, or other apparatus (including amplifiers) that produce heat.
9. Do not defeat the safety purpose of the polarized or grounding-type plug. A polarized plug has two blades with one wider than the other. A grounding type plug has two blades and a third grounding prong. The wide blade or the third prong are provided for your safety. If the provided plug does not fit into your outlet, consult an electrician for replacement of the obsolete outlet.
10. Protect the power cord from being walked on or pinched particularly at plugs, convenience receptacles, and the point where they exit from the apparatus.
11. Only use attachments/accessories specified by the manufacturer.
12. Use only with the cart, stand, tripod, bracket, or table specified by the manufacturer, or sold with the apparatus. When a cart is used, use caution when moving the cart/apparatus combination to avoid injury from tip-over.
13. Unplug this apparatus during lightning storms or when unused for long periods of time.
14. Refer all servicing to qualified service personnel. Servicing is required when the apparatus has been damaged in any way, such as power-supply cord or plug is damaged, liquid has been spilled or objects have fallen into the apparatus, the apparatus has been exposed to rain or moisture, does not operate normally, or has been dropped.
15. Batteries shall not be exposed to excessive heat such as sunshine, fire or the like.



CAUTION:

To completely disconnect this product from the mains, disconnect the plug from the wall socket outlet. The mains plug is used to completely interrupt the power supply to the unit and must be within easy access by the user.

PRECAUTION:

Pour déconnecter complètement ce produit du courant secteur, débranchez la prise de la prise murale. La prise secteur est utilisée pour couper complètement l'alimentation de l'appareil et l'utilisateur doit pouvoir y accéder facilement.

PRECAUCIÓN:

Para desconectar completamente este producto de la alimentación eléctrica, desconecte el enchufe del enchufe de la pared. El enchufe de la alimentación eléctrica se utiliza para interrumpir por completo el suministro de alimentación eléctrica a la unidad y debe de encontrarse en un lugar al que el usuario tenga fácil acceso.

FCC INFORMATION (For US customers)

1. PRODUCT

This product complies with Part 15 of the FCC Rules. Operation is subject to the following two conditions: (1) this product may not cause harmful interference, and (2) this product must accept any interference received, including interference that may cause undesired operation.

2. IMPORTANT NOTICE: DO NOT MODIFY THIS PRODUCT

This product, when installed as indicated in the instructions contained in this manual, meets FCC requirements. Modification not expressly approved by DENON may void your authority, granted by the FCC, to use the product.

3. NOTE

This product has been tested and found to comply with the limits for a Class B digital device, pursuant to Part 15 of the FCC Rules. These limits are designed to provide reasonable protection against harmful interference in a residential installation.

This product generates, uses and can radiate radio frequency energy and, if not installed and used in accordance with the instructions, may cause harmful interference to radio communications. However, there is no guarantee that interference will not occur in a particular installation. If this product does cause harmful interference to radio or television reception, which can be determined by turning the product OFF and ON, the user is encouraged to try to correct the interference by one or more of the following measures:

- Reorient or relocate the receiving antenna.
- Increase the separation between the equipment and receiver.
- Connect the product into an outlet on a circuit different from that to which the receiver is connected.
- Consult the local retailer authorized to distribute this type of product or an experienced radio/TV technician for help.

This Class B digital apparatus complies with Canadian ICES-003.
Cet appareil numérique de la classe B est conforme à la norme NMB-003 du Canada.

⚠ Cautions On Installation / Précautions d'installation / Emplazamiento de la Instalación

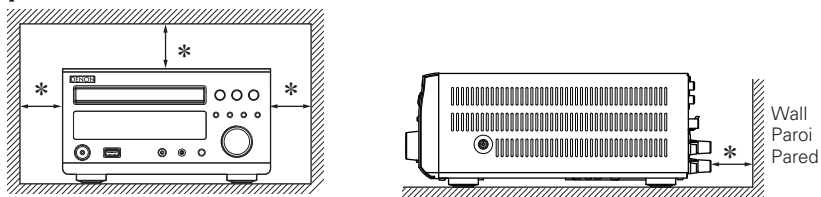

- * **For proper heat dispersal, do not install this unit in a confined space, such as a bookcase or similar enclosure.**
 - More than 0.3 m (12 in.) is recommended.
 - Do not place any other equipment on this unit.
- * **Pour permettre la dissipation de chaleur requise, n'installez pas cette unité dans un espace confiné tel qu'une bibliothèque ou un endroit similaire.**
 - Une distance de plus de 0,3 m (12 po) est recommandée.
 - Ne placez aucun matériel sur cet appareil.
- * **Para la dispersión del calor adecuadamente, no instale este equipo en un lugar confinado tal como una librería o unidad similar.**
 - Se recomienda dejar más de 0,3 m (12 pulg.) alrededor.
 - No coloque ningún otro equipo sobre la unidad.

⚠ NOTES ON USE / OBSERVATIONS RELATIVES A L'UTILISATION / NOTAS SOBRE EL USO

WARNINGS	AVERTISSEMENTS	ADVERTENCIAS
<ul style="list-style-type: none"> • Avoid high temperatures. Allow for sufficient heat dispersion when installed in a rack. • Handle the power cord carefully. Hold the plug when unplugging the cord. • Keep the unit free from moisture, water, and dust. • Unplug the power cord when not using the unit for long periods of time. • Do not obstruct the ventilation holes. • Do not let foreign objects into the unit. • Do not let insecticides, benzene, and thinner come in contact with the unit. • Never disassemble or modify the unit in any way. • Ventilation should not be impeded by covering the ventilation openings with items, such as newspapers, tablecloths or curtains. • Naked flame sources such as lighted candles should not be placed on the unit. • Observe and follow local regulations regarding battery disposal. • Do not expose the unit to dripping or splashing fluids. • Do not place objects filled with liquids, such as vases, on the unit. • Do not handle the mains cord with wet hands. • When the switch is in the OFF position, the equipment is not completely switched off from MAINS. • The equipment shall be installed near the power supply so that the power supply is easily accessible. 	<ul style="list-style-type: none"> • Éviter des températures élevées. Tenir compte d'une dispersion de chaleur suffisante lors de l'installation sur une étagère. • Manipuler le cordon d'alimentation avec précaution. Tenir la prise lors du débranchement du cordon. • Protéger l'appareil contre l'humidité, l'eau et la poussière. • Débrancher le cordon d'alimentation lorsque l'appareil n'est pas utilisé pendant de longues périodes. • Ne pas obstruer les trous d'aération. • Ne pas laisser des objets étrangers dans l'appareil. • Ne pas mettre en contact des insecticides, du benzène et un diluant avec l'appareil. • Ne jamais démonter ou modifier l'appareil d'une manière ou d'une autre. • Ne pas recouvrir les orifices de ventilation avec des objets tels que des journaux, nappes ou rideaux. Cela entraverait la ventilation. • Ne jamais placer de flamme nue sur l'appareil, notamment des bougies allumées. • Veillez à respecter les lois en vigueur lorsque vous jetez les piles usagées. • L'appareil ne doit pas être exposé à l'eau ou à l'humidité. • Ne pas poser d'objet contenant du liquide, par exemple un vase, sur l'appareil. • Ne pas manipuler le cordon d'alimentation avec les mains mouillées. • Lorsque l'interrupteur est sur la position OFF, l'appareil n'est pas complètement déconnecté du SECTEUR (MAINS). • L'appareil sera installé près de la source d'alimentation, de sorte que cette dernière soit facilement accessible. 	<ul style="list-style-type: none"> • Evite altas temperaturas. Permite la suficiente dispersión del calor cuando está instalado en la consola. • Maneje el cordón de energía con cuidado. Sostenga el enchufe cuando desconecte el cordón de energía. • Mantenga el equipo libre de humedad, agua y polvo. • Desconecte el cordón de energía cuando no utilice el equipo por mucho tiempo. • No obstruya los orificios de ventilación. • No deje objetos extraños dentro del equipo. • No permita el contacto de insecticidas, gasolina y diluyentes con el equipo. • Nunca desarme o modifique el equipo de ninguna manera. • La ventilación no debe quedar obstruida por haberse cubierto las aperturas con objetos como periódicos, manteles o cortinas. • No deberán colocarse sobre el aparato fuentes inflamables sin protección, como velas encendidas. • A la hora de deshacerse de las pilas, respete la normativa para el cuidado del medio ambiente. • No exponer el aparato al goteo o salpicaduras cuando se utilice. • No colocar sobre el aparato objetos llenos de líquido, como jarros. • No maneje el cable de alimentación con las manos mojadas. • Cuando el interruptor está en la posición OFF, el equipo no está completamente desconectado de la alimentación MAINS. • El equipo se instalará cerca de la fuente de alimentación de manera que resulte fácil acceder a ella.

Contents

Getting started	2
Accessories	2
Main features	2
Cautions on handling	2
About this manual	2
Discs	3
Discs playable on this unit	3
Holding discs	3
Loading discs	3
Cautions on loading discs	3
Cautions on handling	3
Cautions on storing discs	3
Cleaning discs	3
About the remote control	3
Inserting the batteries	3
Operating range of the remote control	4
Part names and functions	4
Front panel	4
Display	5
Rear panel	5
Remote control	6
Basic connections	8
Speaker connections	8
Connecting the speaker cables	8
Connecting recording components	9
CD recorder / MD recorder / tape deck	9
Connecting an antenna	9
AM/FM	9
Using the AM loop antenna	9
Assembling the AM loop antenna	9
Connecting the power cord	10

Basic operations	10
Preparations	10
Turning the power on	10
Before playing a disc	11
Turning the power off	11
Setting the current time (12-Hour Display)	11
Operations possible during playback	11
Adjusting the master volume	11
Input source switching	11
Adjusting the tone	12
Muting the sound	12
Switching the display's brightness	12
Listening with headphones	12
CD playback	13
Playing CDs	13
Playing repeatedly (Repeat playback)	13
Playing random order (Random playback)	13
Playing tracks in the desired order (Program playback)	13
Switching the display	13
Tuner playback	14
Tuning in Broadcast Stations	14
Automatically presetting FM stations (Auto preset)	14
Presetting FM/AM stations manually	15
Listening to preset stations	15
Setting the preset channels and changing the received frequency on the main unit	15
Advanced connections	16
Control dock for iPod	16
USB memory device	16
iPod	16

Advanced Operations	17
Preparations	17
Before playing control dock for iPod	17
Before playing a USB or an iPod	17
MP3 or WMA playback order of MP3 or WMA files	17
MP3 and WMA files playback	18
MP3 and WMA formats	18
MP3 and WMA files playback	18
Control dock for iPod/iPod® playback	19
Disconnecting the iPod	19
Portable audio player playback	20
Connecting a portable player	20
Portable audio player playback	20
USB memory device playback	20
Playable USB memory formats	20
USB memory device playback	20
Setting the timer	21
Setting the timer	21
Setting the sleep timer	22
Other functions	23
Using an optimizing filter	23
Auto power on	23
Auto source selector function	23
Auto standby	23
Last function memory	23
Resetting the microprocessor	23
Explanation terms	24
Troubleshooting	24
Specifications	26
Index	26

Getting Started
Basic Connections
Basic Operations
Advanced Connections
Advanced Operations
Explanation terms
Troubleshooting
Specifications
Index

Getting started

Thank you for purchasing this DENON product. To ensure proper operation, please read this owner's manual carefully before using the product.

After reading the manual, be sure to keep it for future reference.

Accessories

Check that the following parts are supplied with the product.

① Remote control (RC-1127).....	1
② R03/AAA batteries.....	2
③ Power cord (Cord length: Approx. 6.6 ft / 2 m)	1
④ AM loop antenna	1
⑤ FM indoor antenna	1
⑥ Owner's manual	1
⑦ Warranty (for North America model only).....	1
⑧ Service network list.....	1

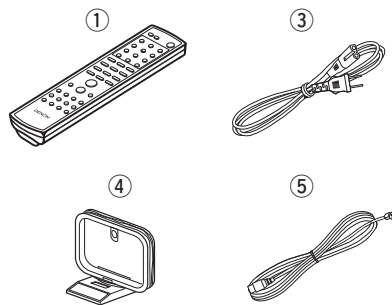

Main features

High quality amplifier stressing sound quality

Equipped with a 30 W + 30 W (6 Ω) high-quality amplifier circuits.

Direct Play for iPod® and iPhone® via USB

Music data from an iPod can be played back if you connect the USB cable supplied with the iPod via the USB port of this unit, and also an iPod can be controlled with the remote control for this unit.

Weight and Dramatic sound

The board and circuit configuration has been redesigned to achieve lower impedance. Since stable current is supplied to the power amp and other sections, it is possible to realize as much as 30 watts of power.

“Simple & Straight” circuit design for sound purity and free of coloration

DENON's popular M series gives you high sound quality based on the “simple & straight” concept. Circuitry is uncomplicated, signal paths are short, and all adverse influences on sound quality have been minimized.

Playback of MP3 and WMA files

Supports playback of discs and USB memory devices on which MP3 or WMA files are recorded. The unit's display can display the title of the track and the name of the artist of the current track. Usable characters “Switching the display” (☞ page 18, 20)

Low standby power consumption

Designed with the environment in mind, the unit consumes just 0.3W while in standby mode.

Cautions on handling

• Before turning the power switch on

Check once again that all connections are correct and that there are no problems with the connection cables.

• Power is supplied to some of the circuitry even when the unit is set to the standby mode. When going on vacation or leaving home for long periods of time, be sure to unplug the power cord from the power outlet.

• Proper ventilation

If the unit is left in a room full of smoke from cigarettes, etc., for long periods of time, the surface of the optical pickup may get dirty, preventing it from receiving signals properly.

• About condensation

If there is a major difference in temperature between the inside of the unit and its surroundings, condensation may form on parts inside the unit, causing it to fail to operate properly.

If this happens, let the unit sit for an hour or two with the power turned off and wait until there is little difference in temperature before using the unit.

• Cautions on using mobile phones

Using a mobile phone near this unit may result in noise. If that occurs, move the mobile phone away from this unit when it is in use.

• Moving the unit

Turn off the power and unplug the power cord from the power outlet. Next, disconnect the cables connected to other system units before moving the unit.

About this manual

☐ Operation buttons

The operations described in this manual are based mainly on remote control operation.

☐ Symbols



This symbol indicates a reference page on which related information is described.



This symbol indicates a supplementary information and tips for operations.

NOTE

This symbol indicates points to remember operations or function limitations.

☐ Illustrations

Note that the illustrations in these instructions are for explanation purposes and may differ from the actual unit.

Discs

Discs playable on this unit

1 Music CDs

Discs marked with the logo below can be played in this unit.



2 CD-R/CD-RW

NOTE

- Discs in special shapes (heart-shaped discs, octagonal discs, etc.) cannot be played. Do not attempt to play them, as doing so can damage the unit.
- Some discs and some recording formats cannot be played.
- Non-finalized discs cannot be played.
- What is finalization?



Finalization is the process that makes recorded CD-R/CD-RW discs playable on compatible players.

Holding discs



Do not touch the signal surface.

Loading discs

- Place the disc in the tray, label side up.
- Make sure the disc tray is fully open when inserting the disc.
- Place the discs flat, 12 cm discs in the outer tray guide (Figure 1), 8 cm discs in the inner tray guide (Figure 2).

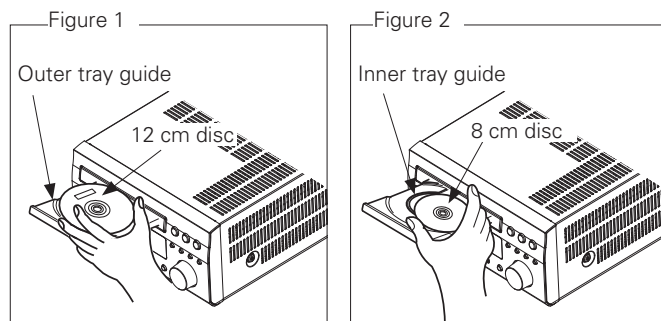

- Place 8 cm discs in the inner tray guide without using an adapter.



- "00 Tr 00 : 00" is displayed if a disc that cannot be played is loaded.
- "NO DISC" is displayed if the disc is loaded upside-down or if no disc is loaded.

NOTE

Do not push the disc tray in by hand when the power is turned off. Doing so could damage the set.

Cautions on loading discs

- Only load one disc at a time. Loading two or more discs can damage the unit or scratch the discs.
- Do not use cracked or warped discs or discs that have been repaired with adhesive, etc.
- Do not use discs on which the sticky part of cellophane tape or labels is exposed or on which there are traces of where labels have been removed. Such discs can get caught inside the player and damage it.

Cautions on handling

- Do not get fingerprints, oil or dirt on discs.
- Take special care not to scratch discs when removing them from their cases.
- Do not bend or heat discs.
- Do not enlarge the hole in the center.
- Do not write on the labeled (printed) surface with ball-point pens, pencils, etc., or stick new labels on discs.
- Water droplets may form on discs if they are moved suddenly from a cold place (outdoors for example) to a warm place, but do not try to dry them off using a hairdryer, etc.

Cautions on storing discs

- Be sure to remove discs after using them.
- Be sure to store discs in their cases to protect them from dust, scratches, warping, etc.
- Do not store discs in the following places:
 1. Places exposed to direct sunlight for long periods of time
 2. Dusty or humid places
 3. Places exposed to heat from heaters, etc.

Cleaning discs

- If there are fingerprints or dirt on a disc, wipe them off before using the disc. Fingerprints and dirt can impair sound quality and cause interruptions in playback.
- Use a commercially available disc cleaning set or a soft cloth to clean discs.

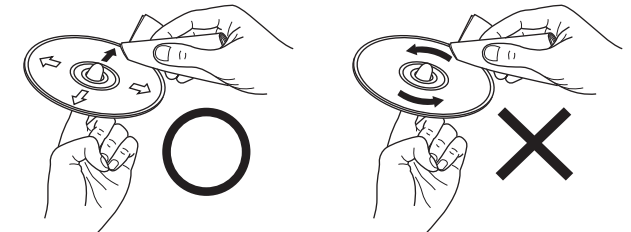

Gently wipe the disc from the inside towards the outside. Do not wipe in a circular motion.

NOTE

Do not use record spray, antistatic agents, benzene, thinner or other solvents.

About the remote control

Inserting the batteries

- 1 Remove the rear cover of the remote control.
- 2 Set two R03/AAA batteries in the battery compartment in the indicated direction.

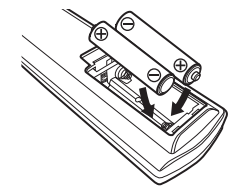
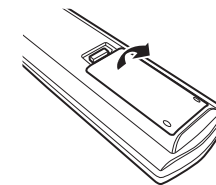

- 3 Put the rear cover back on.

About the remote control

NOTE

- Replace the batteries with new ones if the set does not operate even when the "remote control" is operated close to the unit.
- The supplied batteries are only for verifying operation.
- Be sure to insert the batteries in the proper direction, following the ⊕ and ⊖ marks in the battery compartment.
- To prevent damage or leakage of battery fluid:
 - Do not use a new battery with an old one.
 - Do not use two different types of batteries.
 - Do not attempt to charge dry batteries.
 - Do not short-circuit, disassemble, heat or dispose of batteries in a fire.
- If the battery fluid leaks, carefully wipe the fluid off the inside of the battery compartment and insert new batteries.
- Remove the batteries from the "remote control" if it will not be used for a long time.
- Used batteries should be disposed of in accordance with the local regulations regarding battery disposal.

Operating range of the remote control

Operate the remote control while pointing it at the remote sensor.

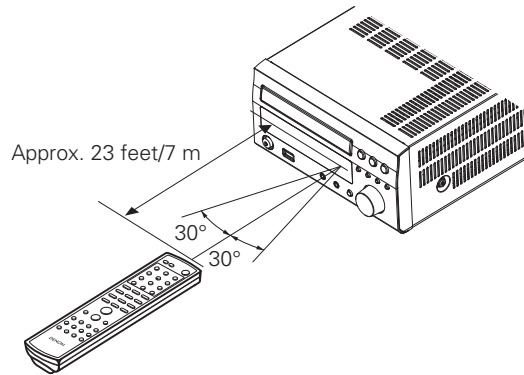

NOTE

The set may function improperly or the "remote control" may not operate if the remote control sensor is exposed in direct sunlight or strong artificial light such as a fluorescent or infrared light.

Part names and functions

For buttons not explained here, see the page indicated in parentheses ().

Front panel

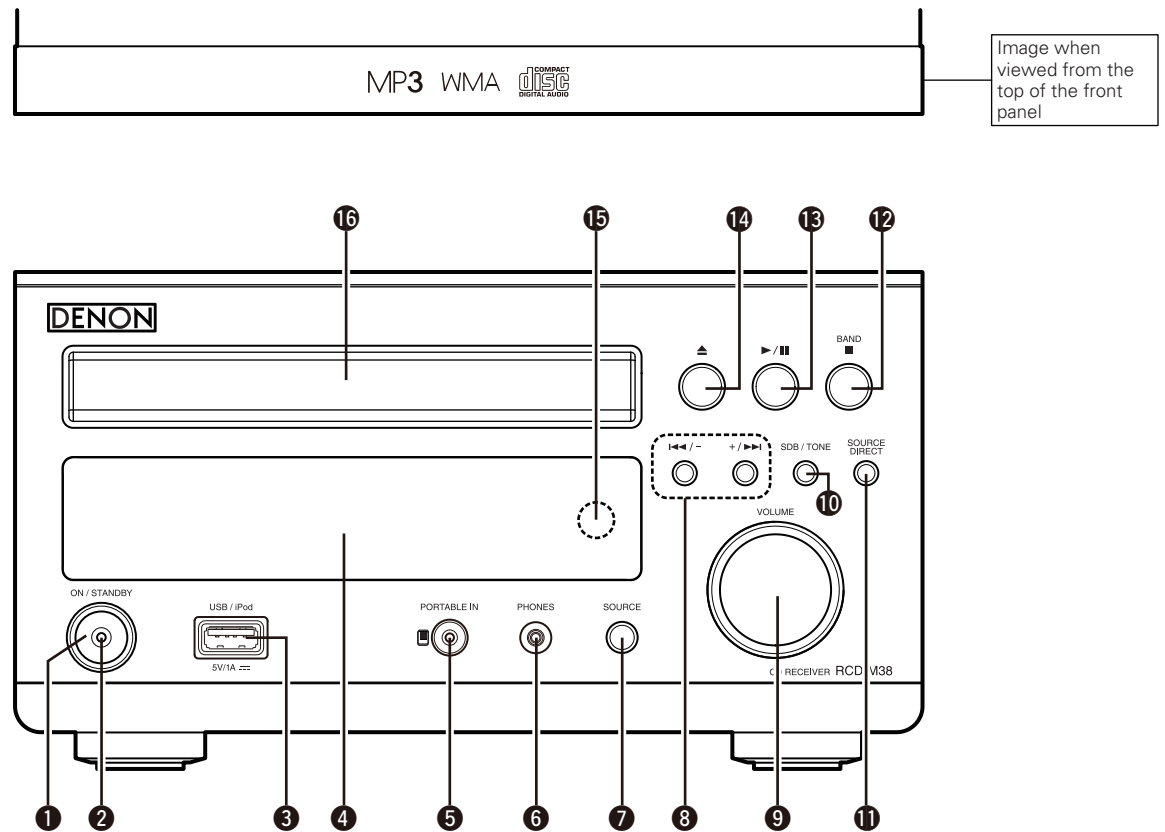
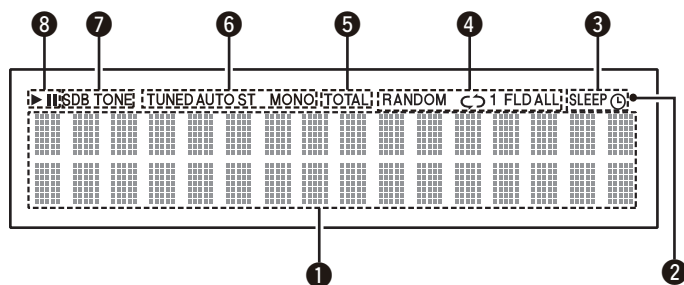

Image when viewed from the top of the front panel

- | | | | |
|--|-----------|---|----------|
| 1 Power operation button (ON/STANDBY) | (11, 17) | 9 Master volume control knob (VOLUME) | (11) |
| 2 Power indicator | (10) | 10 SDB/TONE button | (12) |
| 3 USB port (USB/iPod) | (16) | 11 SOURCE DIRECT button | (12) |
| 4 Display | | 12 BAND/Stop button (BAND/■) | (14, 21) |
| 5 Portable jack (PORTABLE IN) | (20) | 13 Play/Pause button (▶/) | (13, 21) |
| 6 Headphones jack (PHONES) | (12) | 14 Disc tray open/close button (▲) | (11) |
| 7 SOURCE button | (11, 20) | 15 Remote control sensor | (4) |
| 8 Reverse-skip/Forward-skip buttons
Preset/Tuning buttons
(◀◀/-, +/▶▶) | (12 - 15) | 16 Disc tray | (3) |

Display



1 Information display

Various information is displayed here.

2 Remote control signal reception indicator

3 Timer operation indicator

4 Play mode indicator (13, 18, 20)

5 TOTAL indicator

Lights when the total number of tracks and total time of the CD are displayed.

6 Tuner reception mode indicators (14)

7 Tone indicators (12)

SDB: Lights when the super dynamic bass function is set to "ON".

TONE: Lights when the tone (bass/treble) is being adjusted.

8 Playback mode indicators

▶ : During Playback

|| : During pause

Rear panel

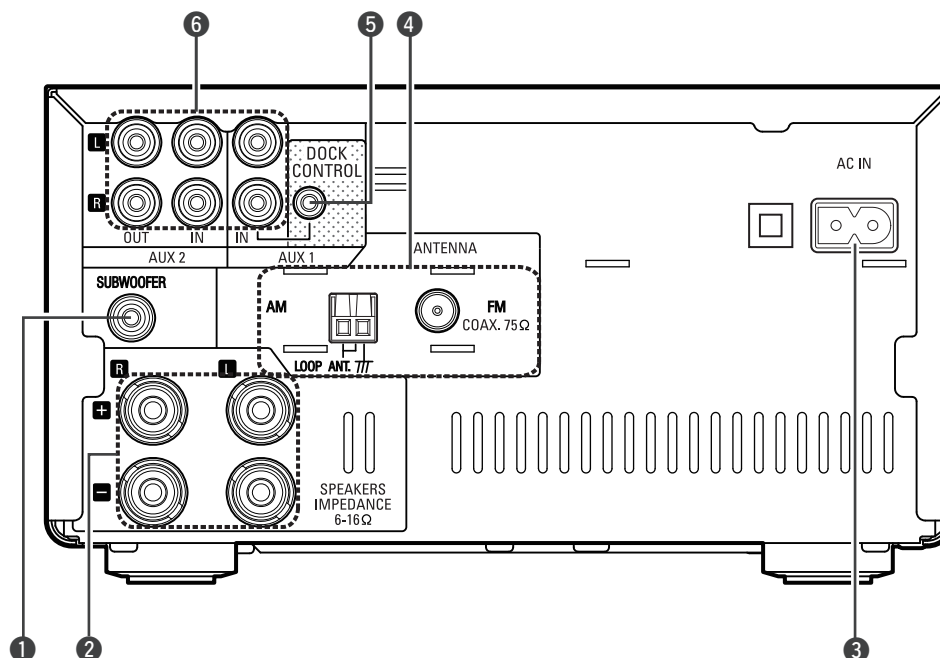

1 Subwoofer connector (SUBWOOFER) (8)

2 Speakers terminals (8)

3 AC inlet (AC IN) (10)

4 FM/AM antenna terminals (9)

5 DOCK CONTROL jack (16)

6 AUX1/AUX2 Analog audio connectors (9)

Part names and functions

Remote control

This section explains the buttons used to playback each source.

Buttons that work with all sources (CD, TUNER, iPod and USB)

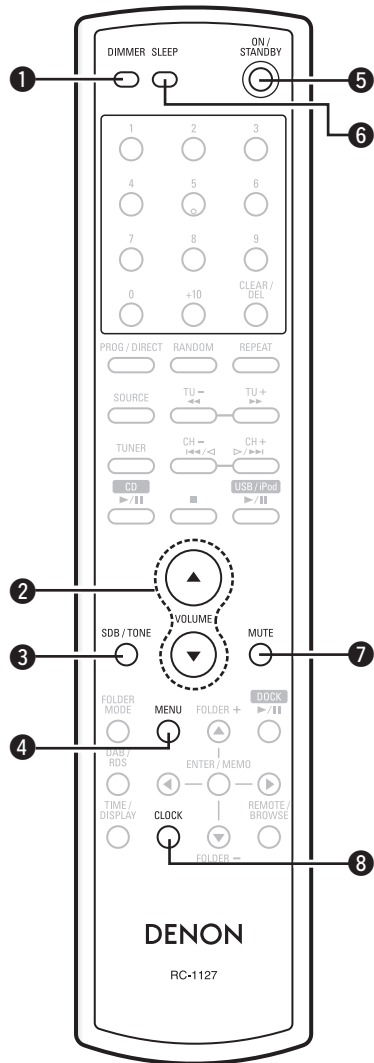

- 1 DIMMER button (12)
- 2 Master volume control buttons (VOLUME) (11)
- 3 SDB/TONE button (12)
- 4 MENU button (11, 14, 15, 21, 23)
- 5 ON/STANDBY button (10, 11, 17)
- 6 SLEEP button (22)
- 7 MUTE button (12)
- 8 CLOCK button (11)

Buttons that work with CDs

The buttons listed at "Buttons that work with all sources" can also be used.

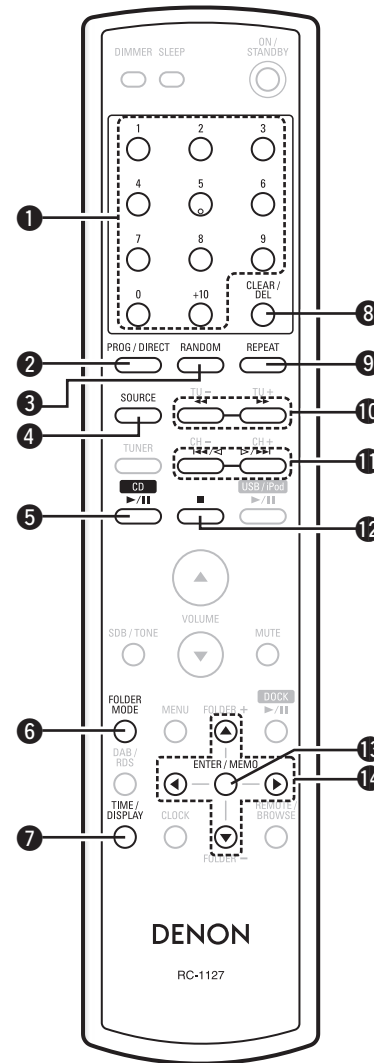

- 1 Number buttons (13)
- 2 PROG/DIRECT button (13)
- 3 RANDOM button (13)
- 4 SOURCE button (11, 13)
- 5 CD ►/|| button (11, 13)
- 6 FOLDER MODE button (18)
- 7 TIME/DISPLAY button (13)
- 8 CLEAR/DEL button (13)
- 9 REPEAT button (13)
- 10 Fast-reverse/Fast-forward buttons (◀◀, ▶▶) (13)
- 11 Reverse-skip/Forward-skip buttons (◀◀, ▶▶) (13)
- 12 Stop button (■) (13)
- 13 ENTER/Memory button (ENTER/MEMO) (18)
- 14 Cursor buttons (▲▼◀▶) (18)

Buttons that work with the tuner

The buttons listed at "Buttons that work with all sources" can also be used.

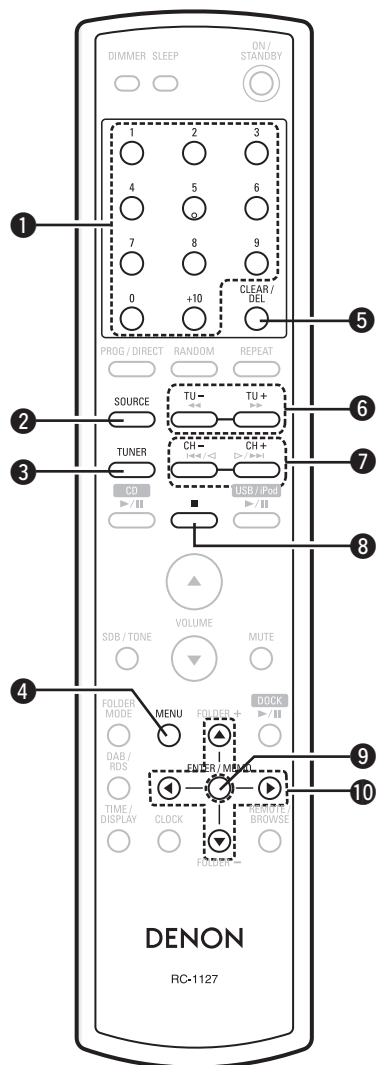

- 1 Number buttons (15)
- 2 SOURCE button (14)
- 3 TUNER button (14)
- 4 MENU button (14, 15)
- 5 CLEAR/DEL button (15)
- 6 Tuning +, - buttons (TU+, TU-) (14)
- 7 Channel +, - buttons (CH+, CH-) (15)
- 8 Stop button (■) (14)
- 9 ENTER/Memory button (ENTER/MEMO) (14, 15)
- 10 Cursor buttons (Δ ∇ ◀ ▶) (14, 15)

Buttons that work with iPods or USBs

The buttons listed at "Buttons that work with all sources" can also be used.

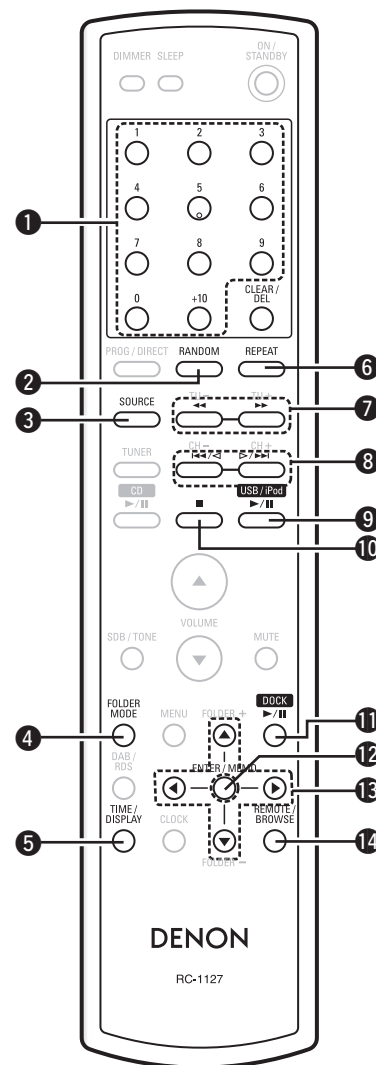

- 1 Number buttons (18)
- 2 RANDOM button (19, 21)
- 3 SOURCE button (20)
- 4 FOLDER MODE button (20)
- 5 TIME/DISPLAY button (19)
- 6 REPEAT button (19, 21)
- 7 Fast-reverse/Fast-forward buttons (◀◀, ▶▶) (19, 21)
- 8 Reverse-skip/Forward-skip buttons (◀◀, ▶▶) (19, 20)
- 9 USB/iPod ▶/|| button (19, 20)
- 10 Stop button (■) (21)
- 11 DOCK ▶/|| button (23)
- 12 ENTER/Memory button (ENTER/MEMO) (19, 20)
- 13 Cursor buttons (Δ ∇ ◀ ▶) (19, 20)
- 14 REMOTE/BROWSE button (19)

Basic connections

This section explains how to connect speakers, recording equipment, and antennas.

For other connections, see the sections below.

- ❑ **Control dock for iPod** (👉 page 16)
- ❑ **USB memory device** (👉 page 16)
- ❑ **iPod** (👉 page 16)

NOTE

- Do not plug in the power cord until all connections have been completed.
- When making connections, also refer to the owner's manual of the other components.
- Be sure to connect the left and right channels properly (left with left, right with right).
- Do not bundle power supply cords together with connection cables. Doing so can result in humming or noise.

Speaker connections

Audio cable (sold separately)	
Pin-plug cable (Black)	
Speaker cable	

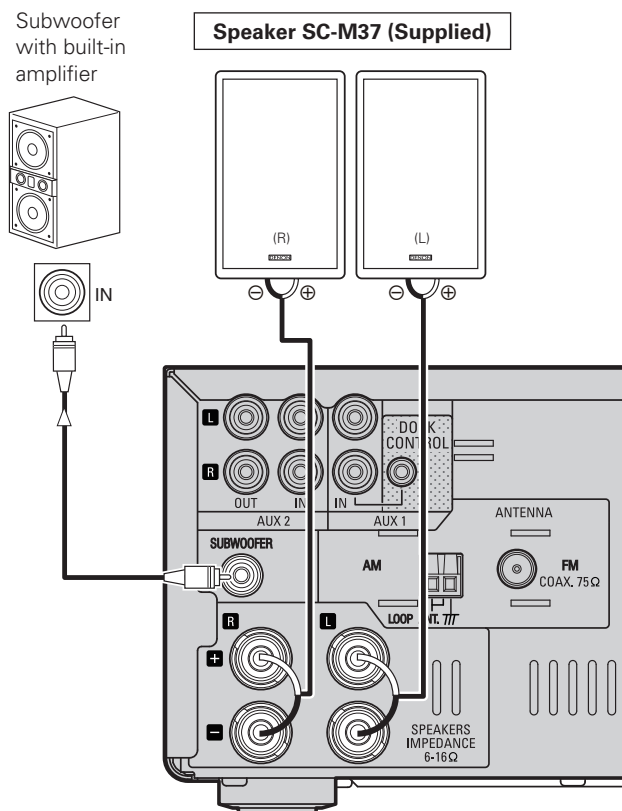

Connecting the speaker cables

Carefully check the left (L) and right (R) channels and + (red) and - (black) polarities on the speakers being connected to the unit, and be sure to connect the channels and polarities correctly.

- 1** Peel off about 10 mm of sheathing from the tip of the speaker cable, then either twist the core wire tightly or apply solder to it.



- 2** Turn the speaker terminal counterclockwise to loosen it.



- 3** Insert the speaker cable's core wire to all the way into the speaker terminal.



- 4** Turn the speaker terminal clockwise to tighten it.



NOTE

- Use speakers with an impedance of 6 to 16 Ω . The protection circuit may be activated if speakers with an impedance other than specified are used.
- Connect the speaker cables so they do not stick out of the speaker terminals. The protection circuit may be activated if the wires touch the rear panel or if the + and - sides touch each other (👉 "Protection circuit").
- Never touch the speaker terminals while the power supply is connected. Doing so could result in electric shock.

Protection circuit

The protection circuit is be activated in the following situations:

- If the speaker cable wire touches the rear panel or screws or if the speaker cable wire touches the speaker cable's + and - sides are touching
- If the surrounding temperature is extremely high
- If the inside of the amplifier gets hot to extended use at a high output

If this happens, unplug the power cord, then check the connections of the speaker cables and input cables. If the unit becomes very hot, wait for it to cool off and improve the ventilation around it. After doing this, plug the power cord back in.

If the protection circuit is activated even though there are no problems with the ventilation around the unit or in connections, the unit may be damaged. Turn off the power and then contact a DENON service center.

Connecting recording components

CD recorder / MD recorder / tape deck

Audio cable (sold separately)

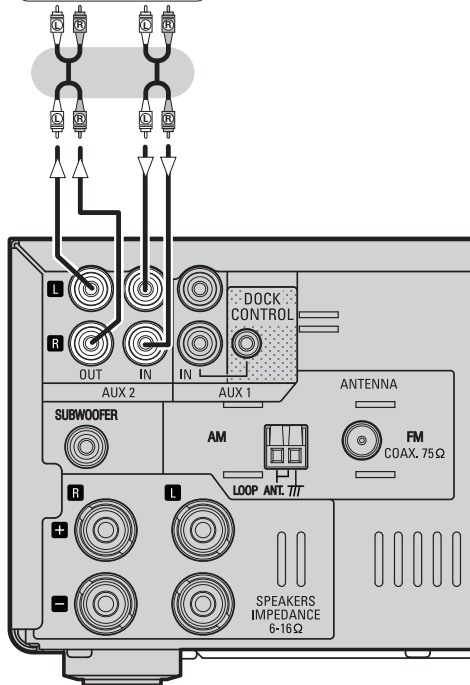
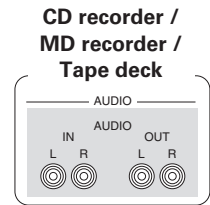
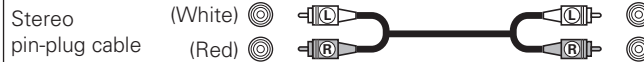

Connecting an antenna

AM/FM

- Connect the FM antenna or AM loop antenna included with the unit to enjoy listening to radio broadcasts.
- After connecting the antenna and receiving a broadcast signal (see page 14 "Tuning in Broadcast Stations"), use tape to fix the antenna in a position where noise is the lowest.

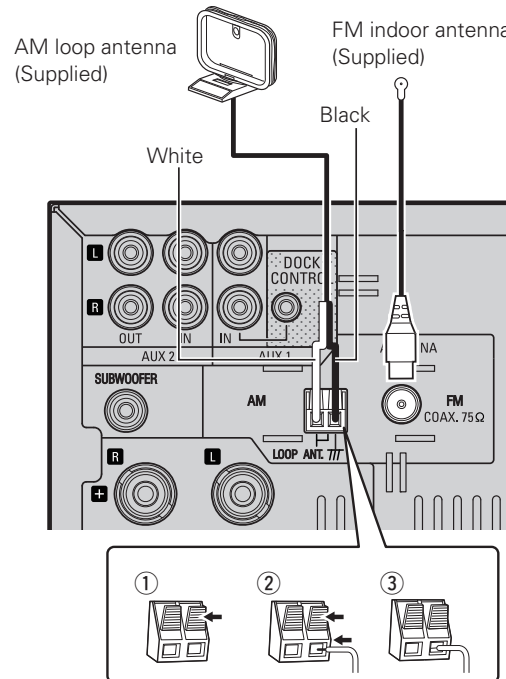

NOTE

- Do not connect two FM antennas simultaneously.
- Even if an external AM antenna is used, do not disconnect the AM loop antenna.
- Make sure the AM loop antenna lead terminals do not touch metal parts of the panel.
- If you are unable to receive a good broadcast signal, we recommend installing an outdoor antenna. Inquire at the retail store where you purchased the unit for details.

Using the AM loop antenna

- To use suspended on a wall
Suspend directly on the wall without assembling.
- To use standing alone
Use the procedure below to assemble.

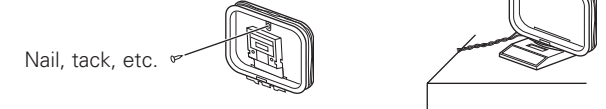

Assembling the AM loop antenna

- 1 Put the stand section through the bottom of the loop antenna from the rear and bend it forward.
- 2 Insert the projecting part into the square hole in the stand.

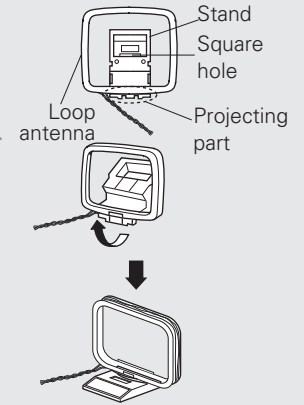

Connecting the power cord

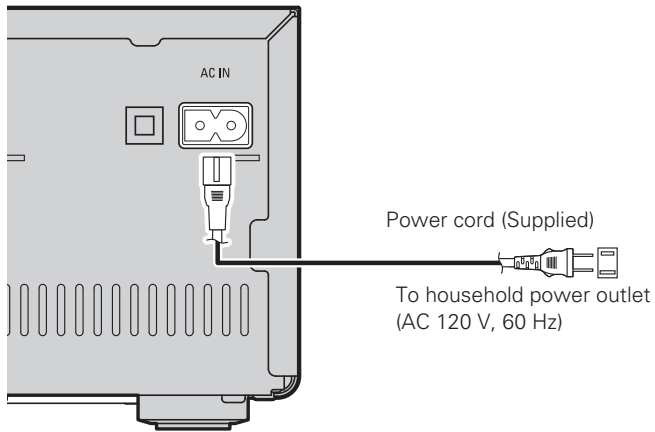

NOTE

- Only use the supplied power cord.
- Be sure the power cord is unplugged from the power outlet before connecting or disconnecting it to the AC IN.

Basic operations

Symbols used to indicate buttons in this manual

- Button located on both the main unit and the remote control → **BUTTON**
- Button only on the main unit → **<BUTTON>**
- Button only on the remote control → **[BUTTON]**

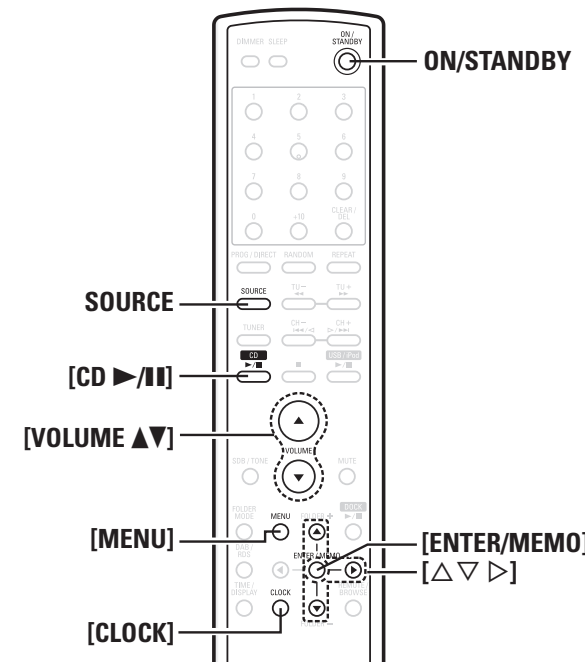
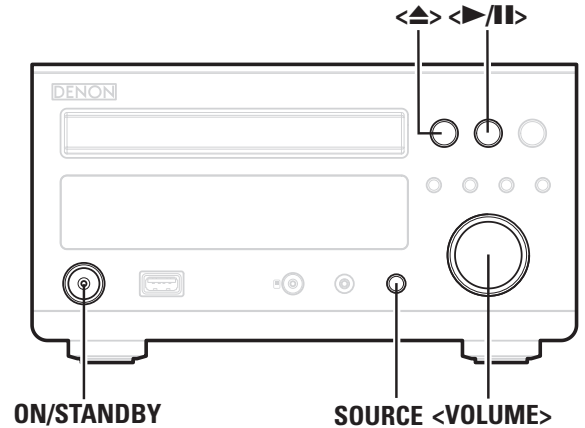

This section explains how to set the current time, and how to playback a CD or tuner.
For other operations, see the sections below.

- ❑ **MP3 and WMA files playback** (page 18)
- ❑ **Control dock for iPod/iPod® playback** (page 19)
- ❑ **Portable audio player playback** (page 20)
- ❑ **USB memory device playback** (page 20)
- ❑ **Setting the timer** (page 21)

Preparations

Turning the power on

Press ON/STANDBY.

- The power turns on. Press again to set the power to standby.
- Power indicator
 - StandbyOff
 - Power onGreen
 - When the timer is setOrange

NOTE

- Power continues to be supplied to some of the circuitry even when the power is in the standby mode. When leaving home for long periods of time, either press **ON/STANDBY** to turn off the power, or unplug the power cord from the power outlet.
- Be sure to stop playback before turning the power off.

❑ **Completely turning off the power**

- Unplug the power cord from the wall outlet.
 - Note that the time setting is cleared when the power cord is unplugged from the outlet.
 - The settings made for the various functions may be cleared if the power cord is left unplugged from a power outlet for an extended period of time.

Preparations

Before playing a disc

- 1** Press **ON/STANDBY**.
- 2** Press **SOURCE** to set the input source to “DISC”.
If no disc is loaded “NO DISC” is displayed.
- 3** Insert a disc (see page 3).
 - Press **<▲>** to open/close the disc tray.
 - The disc tray also closes when **<▶/II>** or **[CD ▶/II]** is pressed.

NOTE

Do not place any foreign objects in the disc tray. Doing so could damage it.

Turning the power off**Press ON/STANDBY.**

The power indicator turns off, and so does the power.

NOTE

- Be sure to stop playback before turning the power off.
- Make sure that the disc tray is completely shut before turning off the power.
- Do not push the disc tray in by hand when the power is turned off. Doing so could damage the set.

Setting the current time (12-Hour Display)

[Example] Setting the current time to 10:15 am

- 1** Press **ON/STANDBY** to turn the power on.
- 2** Press **[MENU]**.
Various types of setting menus are displayed.
- 3** Use **[△▽]** to select “CLOCK SETUP”, then press **[ENTER/MEMO]** or **[▷]**.

```

  MENU
+-----+
| C-L-O-C-K  S-E-T-U-P |
+-----+
  
```

- 4** Use **[△▽]** to set the “hours”.

```

  CLOCK SETUP
+-----+
|  :  A-M-1-0- : 0 0 |
+-----+
  
```

- 5** Press **[ENTER/MEMO]** or **[▷]**.
The “minutes” display flashes.

- 6** Use **[△▽]** to set the “minutes”.

```

  CLOCK SETUP
+-----+
|  :  A-M-1-0- : 1-5 |
+-----+
  
```

- 7** Press **[ENTER/MEMO]** or **[▷]**.
The current time is set, and the normal display reappears.

 Checking the current time when the power is on

Press **[CLOCK]**.

Press once more and the display returns to its original condition.

 Checking the current time when the power is set to standby

Press **[CLOCK]**.

The current time is displayed for 10 seconds.

NOTE

The time cannot be set when in the standby mode. Turn on the power first.

Operations possible during playback**Adjusting the master volume**

Either turn **<VOLUME>** or press **[VOLUME ▲▼]**.

The volume level is displayed.

[Adjustable range]

VOLUME 00 – 45, VOLUME MAX

Input source switching

Press **SOURCE** to select the input source.

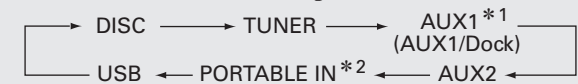

*1 “AUX1/Dock” is displayed when a control dock for iPod is connected to “AUX1”.

*2 “PORTABLE IN” is only displayed when connected.

CD playback

This section explains how to playback CDs. For details on how to playback other media, see the sections below.

- ❑ **MP3 and WMA files playback** (👉 page 18)
- ❑ **Control dock for iPod/iPod® playback** (👉 page 19)
- ❑ **Portable audio player playback** (👉 page 20)
- ❑ **USB memory device playback** (👉 page 20)

Playing CDs

Before you start this operation, perform the procedure in “Before playing a disc” (👉 page 11).

Press **<▶/II>** or **[CD ▶/II]**.

The “▶” indicator lights and playback begins.



- If the source is set to something other than “DISC”, press **[CD ▶/II]** to switch the source to “DISC” and start playback (👉 page 23 “Auto source selector function”).
- The source can also be switched to “DISC” using **SOURCE**.

❑ Stopping playback

Press **<BAND/■>** or **[■]**.

❑ Stopping playback temporarily

Press **<▶/II>** or **[CD ▶/II]**.

II is displayed.

- To resume playback, press **<▶/II>** or **[CD ▶/II]**.

❑ Fast-forwarding and fast-reversing (searching)

During playback, press and hold in **[◀◀, ▶▶]**.

❑ Moving to the beginning of tracks (skipping)

During playback, press **<I◀◀/-, +/▶▶I>** or **[I◀◀, ▶▶I]**.

- The disc skips as many tracks as times the button is pressed.
- When you press reverse once, playback returns to the beginning of the current track.

❑ To play the desired track (remote control only)

Press **[NUMBER] (0 – 9, +10)** to select the track.

[Example] Track 4 : **[4]**

[Example] Track 12 : **[+10], [2]**

[Example] Track 20 : **[+10], [+10], [0]**

Playing repeatedly (Repeat playback)

Press **[REPEAT]**.

Playback in the respective repeat mode starts.

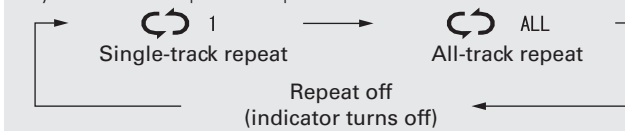

[Selectable items]

↻1 (Single-track repeat) Only 1 track plays repeatedly.

↻ALL (All-track repeat) All tracks play repeatedly.

Repeat off (indicator turns off) Normal playback resumes.



The repeat playback mode is canceled if you open the disc tray or turn off power.

Playing random order (Random playback)

1 In the stop mode, press **[RANDOM]**.

The “RANDOM” indicator lights.

2 Press **<▶/II>** or **[CD ▶/II]**.

The tracks start playing in random order.



If **[REPEAT]** is pressed during random playback, after the current session of random playback is finished, another session in a different order of tracks starts.

NOTE

Random play cannot be set or canceled during playback.

❑ Canceling random playback

While stopped, press **[RANDOM]**.

The “RANDOM” indicator turns off.



The random playback mode is canceled if you open the disc tray or turn off power.

Playing tracks in the desired order (Program playback)

Up to 25 tracks can be programmed.

1 In the stop mode, press **[PROG/DIRECT]**.
“PGM” is displayed.

2 Use **[NUMBER] (0 – 9, +10)** to select the tracks.

[Example] To program tracks 3, 12, 7 to play in that order:
Press **[PROG/DIRECT], [3], [+10], [2], [7]**.

3 Press **<▶/II>** or **[CD ▶/II]**.
Playback starts in the programmed order.

❑ Checking the order of the programmed tracks

In the stop mode, press **▶▶I**.

The track numbers are displayed in the programmed order each time the button is pressed.

❑ To clear the last track programmed

In the stop mode, press **[CLEAR/DEL]**.

The last track programmed is cleared each time the button is pressed.

❑ To clear one programmed track at a time

In the stop mode, press **▶▶I** to select the track to be cleared, then press **[CLEAR/DEL]**.

❑ Clearing the all programmed track

In the stop mode, press **[PROG/DIRECT]**.



- If **[REPEAT]** is pressed during program playback, the tracks are played repeatedly in the programmed order.
- If **[RANDOM]** is pressed during program playback, the programmed tracks are played in random order.
- The program is cleared when the disc tray is opened or the power is turned off.

Switching the display

Press **[TIME/DISPLAY]**.

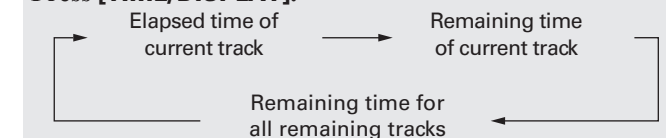

- The display switches each time the button is pressed.

Symbols used to indicate buttons in this manual

Button located on both the main unit and the remote control → **BUTTON**

Button only on the main unit → **<BUTTON>**

Button only on the remote control → **[BUTTON]**

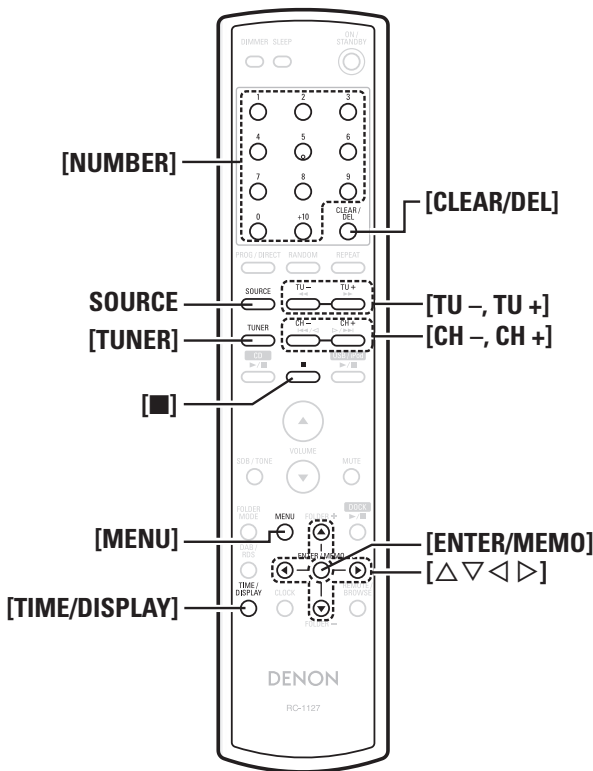
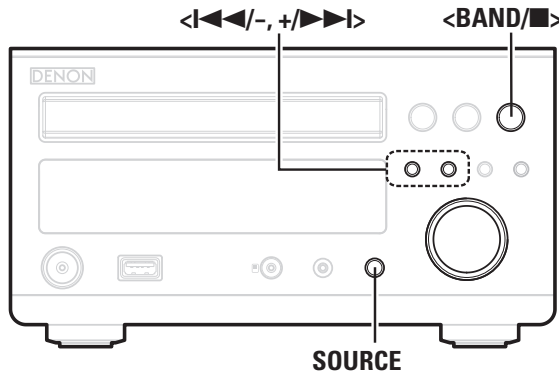

Tuner playback

Tuning in Broadcast Stations

Connect the antenna beforehand (page 9).

1 Press **[TUNER]** or **<BAND/▶>** to select the reception band.

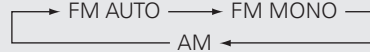

[About the display]

When "FM AUTO" is selected..... "AUTO" is displayed.
 When "FM MONO" is selected..... "MONO" is displayed.
 When "AM" is selected..... The reception mode is not displayed.

2 Use **[TU -, TU +]** to select the reception band.
 When a station is received, the "TUNED" indication will light.



- If the function is set to something other than "TUNER", press **[TUNER]** to switch the function to "TUNER".
- The function can also be switched to "TUNER" using **SOURCE**.

To tune automatically

Press and hold in **[TU -, TU +]** to tune in stations automatically.
 • Stations whose signal is weak cannot be tuned in.

To stop auto tuning

Press **[TU -, TU +]**.



A humming sound may be heard when using a TV nearby while receiving AM programs. If this happens, move the system as far from the TV as possible.

Automatically presetting FM stations (Auto preset)

This unit can be preset with a total of 99 FM and AM broadcast stations.

NOTE

Auto preset is not possible with AM broadcast stations.

Auto presetting with the remote control

Perform this operation when tuned to an FM or AM broadcast station.

1 Press **[MENU]**.

2 Use **[Δ ∇]** to select "TUNER SETUP", then press **[ENTER/MEMO]** or **[▶]**.

3 Use **[Δ ∇]** to select "FM AUTO PRESET", then press **[ENTER/MEMO]** or **[▶]**.

4 Press **[ENTER/MEMO]** while "PRESET ENTER" is flashing.
 Broadcast stations are preset automatically.

Canceling auto presetting

Press **[TUNER]**, **<BAND/▶>** or **[■]**.



Broadcast stations whose antenna signal are weak cannot be preset automatically. If you wish to preset such stations, tune them in manually.

NOTE

When FM auto preset is performed, the channel currently registered as the FM preset is deleted, and the newly preset FM broadcast station is registered to the same number as the deleted channel.

□ Giving station names to preset channels

Names of up to 8 characters can be input.

1 Tune in the preset channel you want to name.

2 Press [ENTER/MEMO] twice.

The display switches to the station name input display.

3 Input the station name.

Names of up to 8 characters can be input.

- [Δ, ▽] button..... Selects the character.
- [▷] button..... Moves the cursor to the right.
- [CLEAR/DEL] button..... Deletes the currently selected character.

- Characters that can be input.

A ~ Z, 0 ~ 9, ^ ' () * + , - . / = (space)

4 Press [ENTER/MEMO].

The characters you have input are entered.

- To give names to other stations, repeat steps 1 to 4.

Presetting FM/AM stations manually

This unit can be preset with a total of 99 FM and AM broadcast stations.

1 Tune in the station you want to preset.

2 Press [ENTER/MEMO].

The minimum number display “P- -” for the unregistered preset flashes.

3 Use [NUMBER] (0 – 9, +10) or [CH –, CH +] to select the number to be preset, then press [ENTER/MEMO].

The reception frequency and reception mode are preset and the display switches to the station name input display.

NOTE

When the registered preset number is selected, “*” is displayed.

To overwrite this preset number, press [ENTER/MEMO].

F M * P:0-1- 1 0 7 . 9 M H z

4 Input the station name.

Names of up to 8 characters can be input.

- [Δ, ▽] button..... Selects the character.
- [▷] button..... Moves the cursor to the right.
- [CLEAR/DEL] button..... Deletes the currently selected character.

- Characters that can be input.

A ~ Z, 0 ~ 9, ^ ' () * + , - . / = (space)

- If you do not want to input a station name, press [ENTER/MEMO] without inputting anything else.
- If you make a mistake when inputting, perform the procedure again. Whatever was previously input is overwritten.

5 Press [ENTER/MEMO].

The characters you have input are entered.

- To give names to other stations, repeat steps 1 to 5.

Listening to preset stations

Use [NUMBER] (0 – 9, +10) or [CH –, CH +] to select the preset number.

Setting the preset channels and changing the received frequency on the main unit

<◀◀/–, +/▶▶> on the main unit can be used both for switching the preset channel and for tuning.

Before operating them, switch the main unit to the “preset mode” or “tuning mode” using the procedure below.

1 Press [MENU].

2 Use [Δ ▽] to select “TUNER SETUP”, then press [ENTER/MEMO] or [▷].

3 Use [Δ ▽] to select “MODE SELECT”, then press [ENTER/MEMO] or [▷].

4 Use [Δ ▽] to select “PRESET MODE” or “TUNING MODE”, then press [ENTER/MEMO].

PRESET MODE

Press <◀◀/–, +/▶▶> on the main unit to switch preset channels.

- This is the same operation as [CH–, CH+] on the remote control.

TUNING MODE

Press <◀◀/–, +/▶▶> on the main unit to change the received frequency.



- This is the same operation as [TU–, TU+] on the remote control.

Advanced connections

This section explains how to connect a control dock for iPod, USB memory device, and iPod.

For other connections, see the sections below.

- ❑ **Speaker connections** (👉 page 8)
- ❑ **Connecting recording components** (👉 page 9)
- ❑ **Connecting an antenna** (👉 page 9)
- ❑ **Connecting the power cord** (👉 page 10)

Audio cable (sold separately)	
Monaural mini-plug cable	
Stereo pin-plug cable	
iPod cable	

Control dock for iPod

Use a DENON control dock for iPod (ASD-11R, ASD-3N, ASD-3W, ASD-51N or ASD-51W sold separately) to connect the set with an iPod.

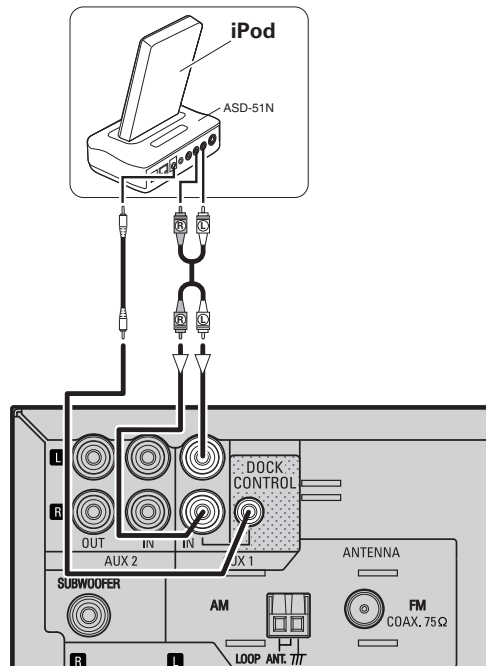

- When using a control dock for iPod, the control dock for iPod must be set. For details, refer to the operating instructions of the control dock for iPod.
- To use an iPod, see "Control dock for iPod/iPod® playback" (👉 page 19).

USB memory device

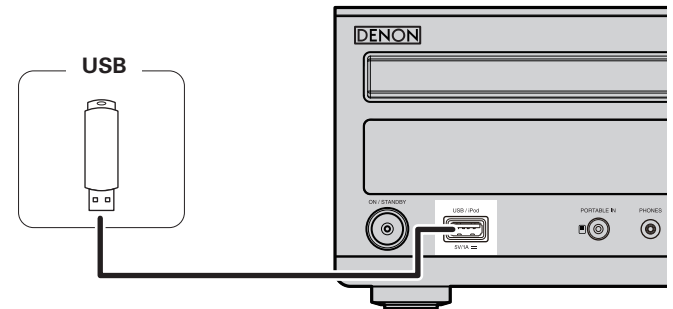

NOTE

- A computer can not be connected to and operate the unit via its USB port.
- Do not use an extension cable when connecting a USB memory device.
- For details about USB memory devices, see "Playable USB memory formats" (👉 page 20).

iPod

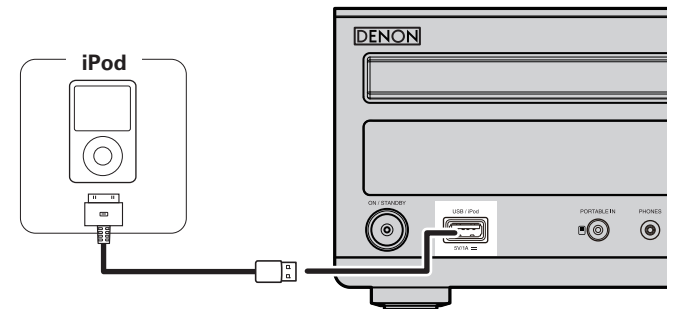

- To connect an iPod to this unit, use the iPod cable supplied with the iPod.
- With this unit, playback via iPod (5th generation or later), iPod touch, iPod classic, or iPod nano can be performed. For details, check the Web (www.denon.com).

MP3 and WMA files playback

This section explains how to playback MP3 and WMA files that are recorded onto a CD-R or CD-RW. For details on how to playback files recorded onto media other than CD-R or CD-RW, see the following sections.

- ❑ **Portable audio player playback** (👉 page 20)
- ❑ **USB memory device playback** (👉 page 20)
- ❑ **Control dock for iPod/iPod® playback** (👉 page 19)

There are many music distribution sites on the Internet allowing you to download music files in MP3 or WMA (Windows Media® Audio) format. The music (files) downloaded from such sites can be stored on CD-R or CD-RW discs and played on this unit.

"Windows Media" and "Windows" are registered trademarks or trademarks in the United States and other countries of Microsoft Corporation of the United States.

MP3 and WMA formats

CD-R and CD-RW discs created in the format described below can be played.

❑ Writing software format

ISO9660 level 1

When written in other formats, it may not be possible to play the disc properly.

❑ Maximum number of playable files and folders

Number of files : 255

Number of folders : 255

❑ File format

MPEG-1 Audio Layer-3

WMA (Windows Media Audio)

❑ Tag data

ID3-Tag (Ver. 1.x and 2.x)

META-Tag

(Compatible with title, artist and album names)

Playable MP3/WMA file			
File format	Sampling frequency	Bit rate	Extension
MP3	32, 44.1, 48 kHz	32 ~ 320 kbps	.mp3
WMA	32, 44.1, 48 kHz	64 ~ 192 kbps	.wma



- Be sure to give files the extension ".MP3" or ".WMA". Files with any other extensions or with no extensions cannot be played.
- In accordance with copyright laws, recordings you have made should only be used for your personal enjoyment and may not be used in other ways without permission of the copyright holder.

MP3 and WMA files playback

1 Load a CD-R or CD-RW disc containing music files in the MP3 or WMA format into the disc tray (👉 page 3).

2 Press [FOLDER MODE] and select "Folder Mode" or "Disc Mode".

Folder Mode ↔ Disc Mode

[About the display]

When "Folder Mode" is selected "FLD" indicator lights.

When "Disc Mode" is selected "FLD" indicator turns off.

Folder Mode All the files in the selected folder are played.

Disc Mode After the selected folder and files are played, all the files in all the folders are played.

3 Use [FOLDER +, -] to select the folder to be played.

4 Use [◀▶, ▶▶] or [◀ ▶] to select the file to be played.

5 Press <▶/||> or [CD ▶/||].

❑ To switch the folder or file during playback

Folder

Use [FOLDER +, -] to select the folder, then press [ENTER/MEMO].

File

Use [◀ ▶] to select the file, then press [ENTER/MEMO].

Also use [◀▶, ▶▶] to select the file, or use [NUMBER] (0 - 9, +10) to select the file number.

- The folder and file numbers are set automatically when the disc is loaded.



- Copyright-protected files cannot be played.
- Depending on the application software used for writing, it may not be possible to write the data properly.
- Depending on the disc's recording conditions, it may not be possible to play some discs properly.

❑ Switching the display

During playback, press [TIME/DISPLAY].



- The characters that can be displayed are as follows:

A-Z | a-z | 0-9

! " # \$ % & ; : < > ? @ \ [] _ ` { } ~ ^ ' () * + , - . / = (space)

❑ To play repeatedly

Press [REPEAT].

Playback starts in the respective repeat mode.

- The selectable repeat modes differ in the "Folder Mode" and the "Disc Mode".

When "Folder Mode" is selected:



When "Disc Mode" is selected:

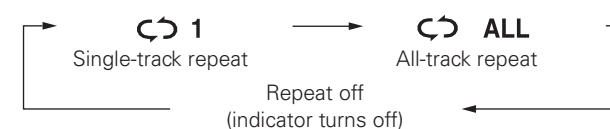

[Selectable items]

When "Folder Mode" is selected:

↻ 1 FLD Only the selected track is played repeatedly.

↻ FLD All the files in the selected folder are played repeatedly.

FLD Folder mode playback resumes.

When "Disc Mode" is selected:

"Playing repeatedly (Repeat playback)" (👉 page 13)

❑ Setting random playback

"Playing random order (Random playback)" (👉 page 13)



Programmed playback is not possible with MP3/WMA discs.

Symbols used to indicate buttons in this manual

- Button located on both the main unit and the remote control → **BUTTON**
- Button only on the main unit → **<BUTTON>**
- Button only on the remote control → **[BUTTON]**

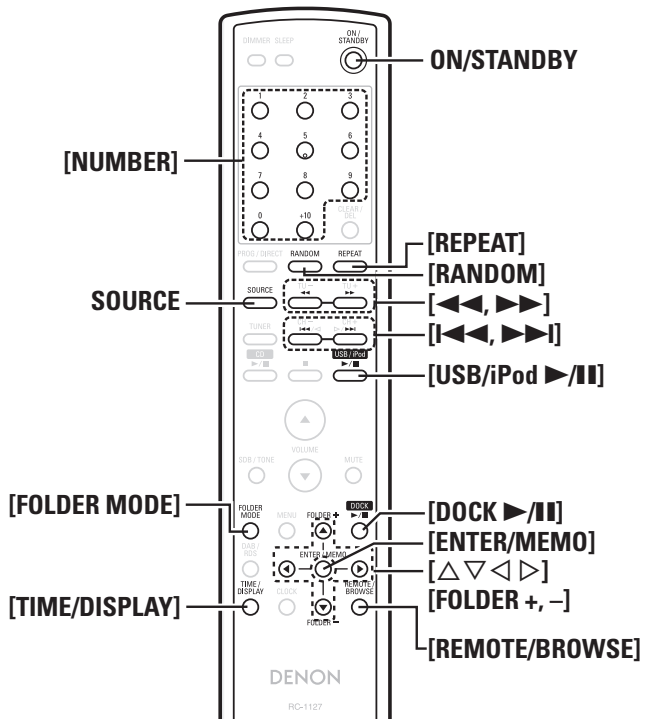
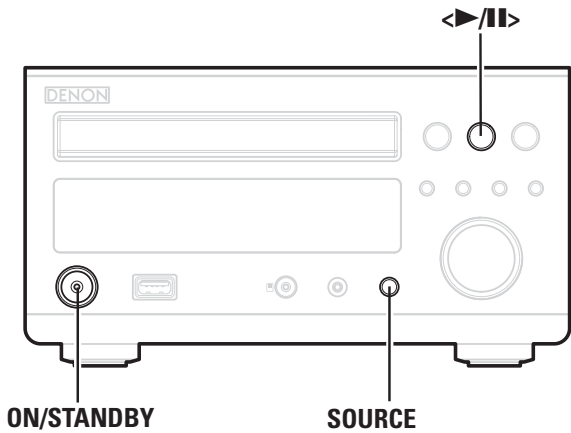

Control dock for iPod/iPod® playback

With this unit, you can listen to music on an iPod. It is also possible to operate the iPod from the main unit or remote control.



“Made for iPod” and “Made for iPhone” mean that an electronic accessory has been designed to connect specifically to iPod or iPhone, respectively, and has been certified by the developer to meet Apple performance standards. Apple is not responsible for the operation of this device or its compliance with safety and regulatory standards. iPhone, iPod, iPod classic, iPod nano, iPod shuffle, and iPod touch are trademarks of Apple Inc., registered in the U.S. and other countries.

- The iPod may only be used to copy or play content that are not copyrighted or content for which copying or playback is legally permitted for your private use as an individual. Be sure to comply with applicable copyright legislation.

NOTE

- DENON will accept no responsibility whatsoever for any loss of iPod data.
- Depending on the type of iPod and the software version, some functions may not operate.
- When connecting an iPhone to this unit, keep the iPhone at least 20cm away from this unit. If the iPhone is kept closer to this unit and a telephone call is received by the iPhone, noise may be output from this device.

1 Playback preparation (☞ page 17 “Preparations”).

2 Press [REMOTE/BROWSE] to select the display mode. The mode switches each time the button is pressed.

	[Selectable mode]	Browse mode	Remote mode
Display location		Main unit display	iPod display
Playable files	Audio file Video file	✓ ✓	✓ ✓
Active buttons	Remote control and main unit iPod®	✓ ✓	✓ ✓

3 Use [Δ▽] to select the item, then press [ENTER/MEMO] to select the music file to be played.

4 Control dock for iPod operation

Press **<▶/||>** or **[DOCK ▶/||]**.

Playback starts.

iPod operation

Press **<▶/||>** or **[USB/iPod ▶/||]**.

Playback starts.

Remote control and iPod button relations

Remote control buttons	iPod buttons	Operation on this unit
USB/iPod ▶/ 	▶ 	Play the track / Pause the track.
DOCK ▶/ 	▶ 	Play the track / Pause the track.
◀◀, ▶▶	◀◀, ▶▶	Play the track from the beginning/ Play the next track.
◀◀, ▶▶ Press and hold	◀◀, ▶▶ Press and hold	Fast-reverse the track/Fast-forward the track.
Δ, ▽	Click Wheel	Select an item.
ENTER/MEMO or ▷	Select	Enter the selection or plays the track.
REMOTE/BROWSE	-	Switch between the browse mode and the remote mode.
REPEAT	-	Switch the repeat function
RANDOM	-	Switch the shuffle function
◀	MENU	Display the menu or return to the previous menu.

To switch the display

During playback, press **[TIME/DISPLAY]**.

The display switches each time the button is pressed.



Disconnecting the iPod

1 Press ON/STANDBY to set the standby mode.

2 Disconnect the iPod cable from the USB port.

Portable audio player playback

Your portable audio player can be connected to this unit's portable jack to play tracks on the portable audio player.

Connecting a portable player

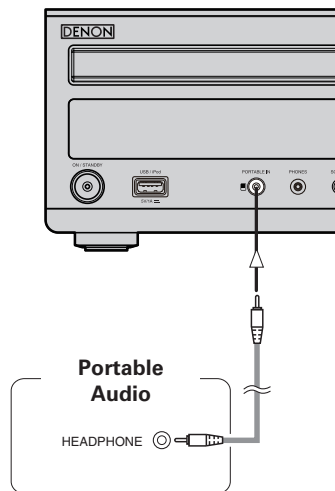

Connect this unit and portable audio player using a separately sold mini-stereo audio cable.

Portable audio player playback

1 Press **SOURCE** to select "PORTABLE IN".

2 Play the portable audio player.

- The player's audio is output.
- Also read the portable audio player's operating instructions.

NOTE

When using the portable player's headphone jack, set the volume on the portable player to an appropriate level.

USB memory device playback

Playable USB memory formats

Files stored on USB memory devices created in the formats below can be played.

❑ USB-compatible file systems

"FAT16" or "FAT32"

- If the USB memory device is divided into multiple partitions, only the top drive can be selected.

❑ Maximum number of playable files and folders

Maximum number of files in a folder: 255

Maximum number of folders: 255

❑ File format

MPEG-1 Audio Layer-3

WMA (Windows Media Audio)

❑ Tag data

ID3-Tag (Ver.1.x and 2.x)

META-Tag

(Compatible with title, artist and album names)

Playable MP3/WMA file			
File format	Sampling frequency	Bit rate	Extension
MP3	32, 44.1, 48 kHz	32 ~ 320 kbps	.mp3
WMA	32, 44.1, 48 kHz	64 ~ 192 kbps	.wma



Only music files that are not copyright-protected can be played on this set.

- Contents downloaded from pay sites on the Internet are copyright protected. Also, files encoded in WMA format when ripped from a CD, etc., on a computer may be copyright protected, depending on the computer's settings.

USB memory device playback

1 Playback preparation (☞ page 17 "Before playing a USB or an iPod").

2 Press **[FOLDER MODE]** and select "Folder Mode" or "Memory Mode".

[About the display]

When "Folder Mode" is selected "FLD" indicator lights.

When "Memory Mode" is selected "FLD" indicator turns off.

Folder Mode :

All the files in the selected folder are played.

Memory Mode :

After the selected folder and files are played, all the files in all the folders are played.

3 Use **[FOLDER +, -]** to select the folder to be played.

4 Use **[I◀◀, ▶▶I]** or **[◀ ▶]** to select the file to be played.

5 Press **<▶/||>** or **[USB/iPod ▶/||]**.



- When **[USB/iPod ▶/||]** is pressed when the function is anything other than USB, the function switches to "USB", and the files stored on the USB memory device are played back. (☞ page 23 "Auto source selector function")

- For details on the order of playback for files stored on a USB memory device, see "MP3 or WMA playback order of MP3 or WMA files" (☞ page 17).

❑ To switch the folder or file during playback

Folder

Use **[FOLDER +, -]** to select the folder, then press **[ENTER/MEMO]**.

File

Use **[◀ ▶]** to select the file, then press **[ENTER/MEMO]**.

Use **[I◀◀, ▶▶I]** to select the file, or use **[NUMBER] (0 - 9, +10)** to select the file number.

- The folder and file numbers are set automatically when the USB memory device is loaded.

Symbols used to indicate buttons in this manual

Button located on both the main unit and the remote control → **BUTTON**
 Button only on the main unit → **<BUTTON>**
 Button only on the remote control → **[BUTTON]**

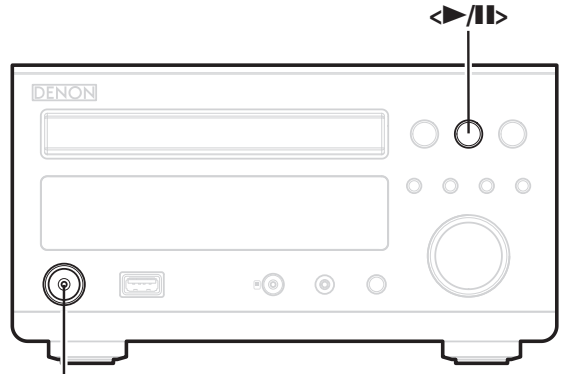

ON/STANDBY

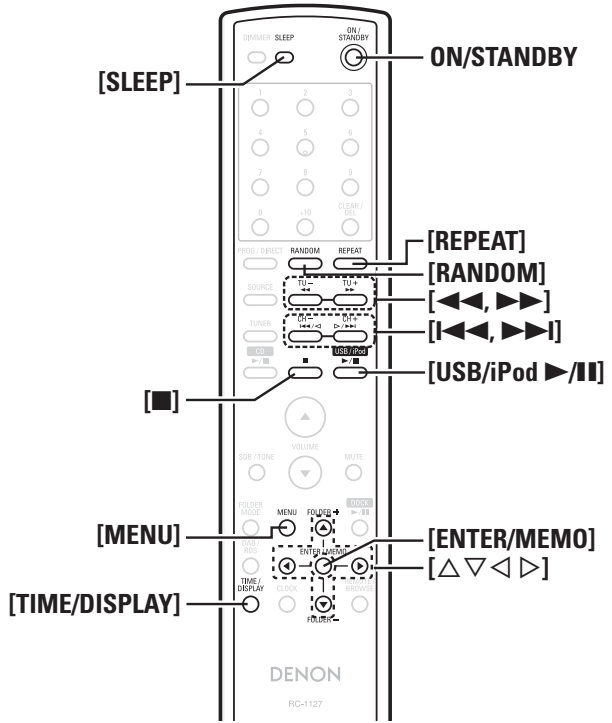

USB memory device playback

- ❑ **Stopping playback**
Press [■].
- ❑ **Stopping playback temporarily**
Press <▶/||> or [USB/iPod ▶/||].
The || is displayed.
• To resume playback, press <▶/||> or [USB/iPod ▶/||].
- ❑ **Fast-forwarding and fast-reversing (searching)**
During playback, press and hold in [<<<, >>>].
- ❑ **Playing repeatedly**
Press [REPEAT].
- ❑ **Playing random order**
In the stop mode, press [RANDOM].
- ❑ **Switching the display**
During playback, press [TIME/DISPLAY].



- The characters that can be displayed are as follows:
- | | | |
|-----|-----|-----|
| A-Z | a-z | 0-9 |
|-----|-----|-----|
- ! " # \$ % & ; : < > ? @ \ [] _ ` { } ~ ^ ' () * + , - . / = (space)

NOTE

- DENON will take no responsibility whatsoever for any loss or damage to data on USB memory devices when using the USB memory device connected to this unit.
- USB memory devices will not work via a USB hub.
- DENON does not guarantee that all USB memory devices will operate or be supplied power. When using a USB connection type portable hard disk of the type for which power can be supplied by connecting an AC adapter, we recommend using the AC adapter.

Setting the timer

This device can playback using the timer playback (everyday timer, once timer) and sleep timer.

❑ **Timer operation when the time settings for timers overlap**

When the sleep timer is set

- Automatically stops playback after the time set for the sleep timer has elapsed.

When the once timer and everyday timer are both set (sleep timer is not set)

- Automatically starts playback at the earlier timer start time set for either of the timers.
- Automatically stops playback at the earlier timer stop time set for either of the timers.

If the current time is not set, enter timer setting mode to get time setting mode.

Setting the timer

- **Everyday timer ("EVERY DAY")**
Playback starts and stops (the power turns off) at the set times each day.
- **Once timer ("ONCE")**
Playback starts and stops (the power turns off) once only at the set times.

- 1** Press [MENU].
- 2** Use [Δ ▽] to select "TIMER SETUP", then press [ENTER/MEMO] or [▷].
- 3** Use [Δ ▽] to select the timer mode, then press [ENTER/MEMO] or [▷].

MODE SELECT
 +O-N-C-E-T-I-M-E-R
 /-----/

ONCE ↔ EVERYDAY

Getting Started
Basic Connections
Basic Operations
Advanced Connections
Advanced Operations
Explanation terms
Troubleshooting
Specifications
Index

Setting the timer

4 Use [△▽] to select the source, then press [ENTER/MEMO] or [▷].

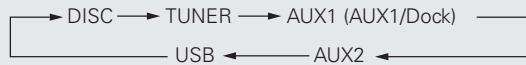

• "AUX1/Dock" is displayed only when control dock for iPod is connected.

5 **Only when the "TUNER" function is selected**

Use [△▽] to select the preset number, then press [ENTER/MEMO] or [▷].

• When no name has been registered for the selected preset number, the frequency appears after the preset number is displayed.

6 Use [△▽] to select "hours" for the timer start time, then press [ENTER/MEMO] or [▷].



7 Use [△▽] to select "minutes" for the timer start time, then press [ENTER/MEMO] or [▷].



8 Use [△▽] to select "hours" for the timer stop time, then press [ENTER/MEMO] or [▷].



9 Use [△▽] to select "minutes" for the timer stop time, then press [ENTER/MEMO] or [▷].



10 Use [◀▶] to select "ON" or "OFF" for the timer, then press [ENTER/MEMO].

- The (L) indicator lights and the timer setting is entered.
- The timer settings are displayed for 3 seconds.



11 Press ON/STANDBY to set the power to standby. Timer standby mode is set, and the power indicator lights orange.

Setting the timer to on or off

- ① Press [MENU].
- ② Use [△▽] to select "TIMER ON/OFF", then press [ENTER/MEMO].
- ③ Use [△▽] to select "ONCE" or "EVERYDAY".
- ④ Use [◀▶] to select "ON" or "OFF" for the timer, then press [ENTER/MEMO]. The timer settings are displayed after this.

• When set to "OFF", time operation is disabled, but the timer settings remain unchanged.

To check the timer settings

- ① Press [MENU].
- ② Use [△▽] to select "TIMER ON/OFF", then press [ENTER/MEMO].
- ③ When "ON" is displayed for the timer setting, press [ENTER/MEMO]. The timer settings are displayed for 3 seconds.

To change the timer settings

Perform the operations at "Setting the timer" (page 21).

To change the setting while setting the timer

Press [◀]. The setting returns to the previous step. Display the setting you want to change, then make the desired setting.

When performing a timer setting with DENON control dock for iPod (ASD-11R, ASD-3N, ASD-3W, ASD-51N or ASD-51W)

Pause the track you want to play, and keep the power on for DENON control dock for iPod.

Setting the sleep timer

Use this function to automatically switch the power to the standby mode after a specific amount of time (minutes). The sleep timer can be set to up to 90 minutes, in steps of 10 minutes.

Press [SLEEP] during playback and select the setting time.

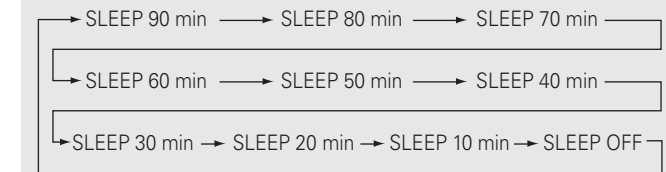

• After about 5 seconds, the setting is entered and the display returns to as it was before.

Canceling the sleep timer

Either press [SLEEP] to select "SLEEP OFF" or press ON/STANDBY.

To check the time remaining until the sleep timer is activated

Press [SLEEP].

Symbols used to indicate buttons in this manual

Button located on both the main unit and the remote control → **BUTTON**
 Button only on the main unit → **<BUTTON>**
 Button only on the remote control → **[BUTTON]**

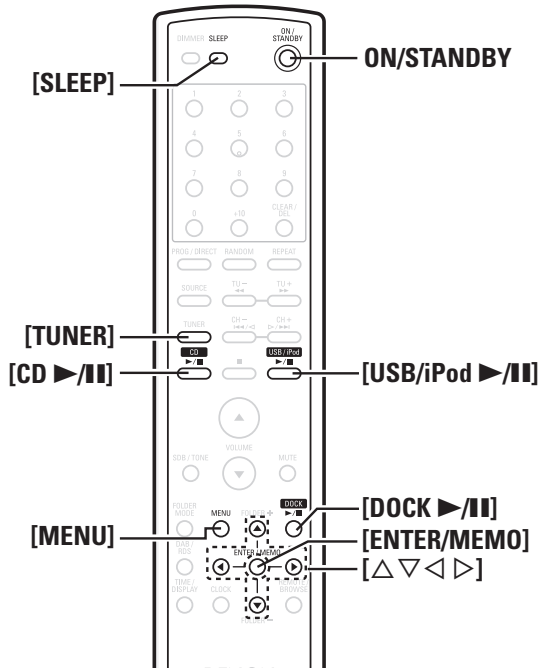
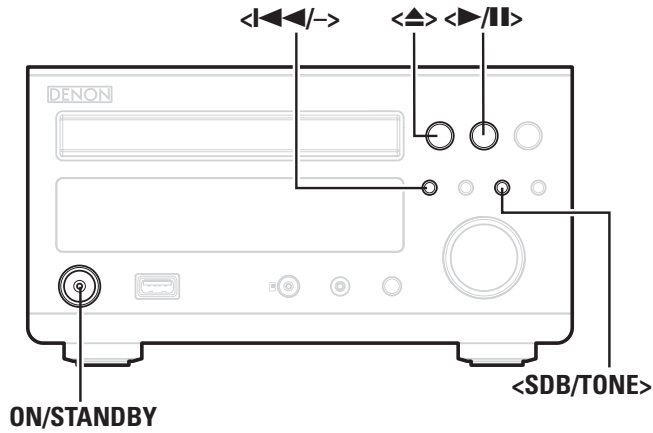

Other functions

Using an optimizing filter

An optimizing filter suited for the properties of the speakers (SC-M37) can be used.

- 1 Press **[MENU]**.
- 2 Use **[Δ ∇]** to select “SPK OPTIMISE”, then press the **[ENTER/MEMO]** or **[▷]**.
- 3 Use **[Δ ∇]** to select “ON”, then press the **[ENTER/MEMO]** or **[▷]**.
The setting is entered.

- ON** The response is optimized for the speakers (SC-M37, sold separately).
- OFF** The response is flat.

Auto power on

When the power is in standby, the power turns on when any of the buttons below other than **ON/STANDBY** is operated, and the respective operation is performed.

- **<▶▶>** The disc tray opens.
- **<▶/||>** for the different source Playback of that source starts.
- **[TUNER]** Playback of the tuner starts.

NOTE

The Auto Power On function cannot be used with control dock for iPod.

Auto source selector function

When one of the buttons below is pressed, it switches to that source and starts playback on that source.

- **[CD ▶/||]** The source switches to “DISC” and the disc starts playing.
- **[USB/iPod ▶/||]** The source switches to “USB” and the USB starts playing.
- **[DOCK ▶/||]** The source switches to “AUX1/Dock” and the iPod starts playing.
- **[TUNER]** The source switches to “TUNER” and the band last set is tuned in.

Auto standby

With the Auto standby ON, this unit will automatically enter the standby mode after about 30 continuous minutes of stop mode with no operation.

- 1 Press **[MENU]**.
- 2 Use **[Δ ∇]** to select “AUTO STANDBY”, then press **[ENTER/MEMO]** or **[▷]**.
- 3 Use **[Δ ∇]** to select “ON”, then press **[ENTER/MEMO]** or **[▷]**.
The setting is entered.

NOTE

In the following situations, the Auto standby function does not operate.

- When an iPod or USB memory device is connected to the USB port on the unit.
- When the source is “TUNER”, “AUX1” or “AUX2”.
- When the source is “AUX1/Dock”, and an iPod is connected to control dock for iPod. (ASD-11R only)
- When the source is “PORTABLE IN” and a device is connected to the portable jack.

Last function memory

This stores the settings as they were immediately before going into the standby mode.

When the power is turned back on, the settings are restored to as they were immediately before going into the standby mode.

Resetting the microprocessor

Perform this procedure if the display is abnormal or if operations cannot be performed.

When the microprocessor is reset, all the settings are reset to their default values.

- 1 Unplug the power cord.
- 2 Plug the power cord into a power outlet while pressing **<◀◀/→>>** and **<SDB/TONE>** simultaneously.
 - “INITIALIZE” is displayed.



If “INITIALIZE” does not display in step 2, start over from step 1.

Explanation terms

B

Bit rate

This expresses the read amount per 1 second of video/audio data recorded in a disc.

D

Dynamic range

The difference between the maximum undistorted sound level and the minimum sound level that is discernible above the noise emitted by the device.

F

Finalize

This is processing that enables playing back of disc of CD, which was recorded using a recorder, by other players.

M

MP3 (MPEG Audio Layer-3)

This is an internationally standardized audio data compression scheme, using the "MPEG-1" video compression standard. It compresses the data volume to about one eleventh its original size while maintaining sound quality equivalent to a music CD.

MPEG (Moving Picture Experts Group), MPEG-2, MPEG-4

These are the names for digital compression format standards used for the encoding of video and audio. Video standards include "MPEG-1 Video", "MPEG-2 Video", "MPEG-4 Visual", "MPEG-4 AVC". Audio standards include "MPEG-1 Audio", "MPEG-2 Audio", "MPEG-4 AAC".

P

Protection circuit

This is a function to prevent damage to components within the power supply when an abnormality such as an overload, excess voltage occurs or temperature for any reason.

In this unit, the power indicator blinks and the unit enters standby mode when an abnormality occurs.

S

Sampling frequency

Sampling involves taking a reading of a sound wave (analog signal) at regular intervals and expressing the height of the wave at each reading in digitized format (producing a digital signal).

The number of readings taken in one second is called the "sampling frequency". The larger the value, the closer the reproduced sound is to the original.

Speaker impedance

This is an AC resistance value, indicated in Ω (ohms). Greater power can be obtained with this value smaller.

W

WMA (Windows Media Audio)

This is audio compression technology developed by Microsoft Corporation.

WMA data can be encoded using Windows Media® Player Ver.7, 7.1, Windows Media® Player for Windows® XP and Windows Media® Player 9 Series.

To encode WMA files, only use applications authorized by Microsoft Corporation. If you use an unauthorized application, the file may not work properly.

Troubleshooting

If a problem occurs first check the following:

1. Are the connections correct?
2. Is the set being operated as described in the owner's manual?
3. Are the other components operating properly?

If this unit does not operate properly, check the items listed in the table below. If the problem persists, there may be a malfunction.

In this case, disconnect the power immediately and contact your retail outlet.

[General]

Symptom	Cause	Countermeasure	Page
Set does not operate properly.	<ul style="list-style-type: none"> External noise or interference is causing the set to malfunction. 	<ul style="list-style-type: none"> Reset the microprocessor. 	23
Display not lit and sound not produced when power switched to on.	<ul style="list-style-type: none"> Power cord not plugged in securely. 	<ul style="list-style-type: none"> Check the connections on the set's rear panel and the connection of the power plug to the power outlet. 	10
Display lit but sound not produced.	<ul style="list-style-type: none"> Wrong input source selected. Volume control set to minimum. MUTING is on. 	<ul style="list-style-type: none"> Select the appropriate input source. Turn volume up to suitable level. Switch off MUTING. 	11 12
Display is off.	<ul style="list-style-type: none"> The Dimmer setting is set to "OFF". 	<ul style="list-style-type: none"> Set to something other than "OFF". 	12
Power turns off suddenly and power indicator flashes red. (Flashes at 0.5 second intervals)	<ul style="list-style-type: none"> Protection circuit activated due to a rise in internal temperature. Core wires of two speakers are touching each other or a core wire is sticking out of the terminal and touching the set's rear panel, activating the protection circuit. 	<ul style="list-style-type: none"> Turn off the power, wait for the set to fully cool down, then turn the power back on. Place the set in a well-ventilated location. First unplug the power cord, then twist the core wires tightly or terminate the speaker cables, then reconnect. 	8 II 8
Power turns off suddenly and power indicator flashes red. (Flashes at 0.25 second intervals)	<ul style="list-style-type: none"> Set is damaged. 	<ul style="list-style-type: none"> Turn off the power and contact a DENON service center. 	–

[Remote control]

Symptom	Cause	Countermeasure	Page
Set does not work properly when remote control operated.	• Batteries are worn.	• Replace with new batteries.	4
	• You are operating outside of the specified range.	• Operate within the specified range.	4
	• Obstacle between main unit and remote control.	• Remove the obstacle.	–
	• The batteries are not inserted in the proper direction, as indicated by the polarity marks in the battery compartment.	• Insert the batteries in the proper direction, following the polarity marks in the battery compartment.	4
	• The set's remote control sensor is exposed to strong light (direct sunlight, fluorescent light, etc.).	• Move the set to a place in which the remote control sensor will not be exposed to strong light.	4

[CD]

Symptom	Cause	Countermeasure	Page
"00 Tr 00 : 00" is shown on the display even though a CD is loaded.	• The disc is not properly loaded.	• Reload the disc.	3
Disc does not play when CD ►/ button is pressed.	• The disc is dirty or scratched.	• Wipe the disc clean or replace the disc.	3
A specific part of a disc is not played.	• The disc is dirty or scratched.	• Wipe the disc clean or replace the disc.	3
A CD-R or CD-RW disc cannot be played.	• The disc has not been finalized. • The recording conditions are bad or the quality of the disc itself is poor.	• Finalize the disc then play it. • Use a properly recorded disc.	3 –
MP3 and WMA files cannot be played.	• The file formats, extensions or settings made when the disc was created are not compatible with this unit.	• Create discs with file formats, extensions or settings compatible with this unit.	18

[Tuner]

Symptom	Cause	Countermeasure	Page
Continuous noise is heard when receiving FM programs.	• Antenna cable is not properly connected.	• Connect the antenna cable properly. • Connect an outdoor antenna.	9 –
Hissing or continuous noise is heard when receiving AM programs.	• This may be noise from a TV or interference from a broadcast station.	• Turn off the TV. • Change the position and direction of the AM loop antenna.	– 9

[Control dock for iPod]

Symptom	Cause	Countermeasure	Page
iPod cannot be played.	• Wrong input source selected.	• Select an appropriate input source.	17
	• Cable is not properly connected.	• Reconnect.	16
	• Control dock for iPod's AC adapter is not connected to power outlet.	• Plug the Control dock for iPod's AC adapter into a power outlet.	–

[USB]

Symptom	Cause	Countermeasure	Page
When a USB memory device is connected, "USB" is not displayed.	• The set cannot recognize a USB memory device.	• Check the connection.	16
	• A USB memory device not conforming to mass storage class or MTP standards is connected.	• Connect a USB memory device conforming to mass storage class or MTP standards. • This is not a malfunction. DENON does not guarantee that all USB memory devices will operate or receive power.	– –
	• A USB memory device that the set cannot recognize is connected.	• Connect the USB memory device directly to the USB port.	–
iPod cannot be played.	• USB memory device is connected via USB hub.		–
	• Input source other than "USB" is selected.	• Switch the SOURCE to "USB".	17
Files on a USB memory device cannot be played.	• Cable is not properly connected.	• Reconnect.	16
	• USB memory device is in a format other than FAT16 or FAT32.	• Set the format to FAT16 or FAT32. For details, refer to the USB memory device's operating instructions.	–
	• USB memory device is divided into multiple partitions.	• When divided into multiple partitions, only files stored in the top partition can be played.	–
	• Files are stored in a non-compatible format.	• Record the files in a compatible format.	20
	• You are attempting to play a file that is copyright protected.	• Files that are copyright protected cannot be played on this set.	20

Specifications

Audio section

Power amplifier

Rated output: 30 W + 30 W (6 Ω, 1 kHz T.H.D 10 %)

Tuner section

Receiving range: FM: 87.5 MHz – 107.9 MHz AM: 520 kHz – 1710 kHz
Usable sensitivity: FM: 1.5 μV/75 Ω AM: 20 μV
FM stereo separation: 35 dB (1 kHz)

CD section

Playback frequency response: 2 Hz – 20 kHz
Wow & flutter: Below measurable limits (± 0.001%)
Sampling frequency: 44.1 kHz

Clock/Timer section

Clock method: Crystal oscillator (Within 1 – 2 minutes per month)
Timer: Everyday/Once timer: One each
 Sleep timer: 90 minutes, maximum

General

Power supply: AC 120 V, 60 Hz
Power consumption: 80 W
 Approx. 0.3 W (standby)
Maximum external dimensions: 210 (W) x 115 (H) x 308.5 (D) mm (8-17/64" x 4-33/64" x 12-9/64")
Weight: 4.3 kg (9 lbs 7 oz)

Remote control (RC-1127)

Power supply: R03/AAA Type (two batteries)
Maximum external dimensions: 49 (W) x 220 (H) x 24 (D) mm (1-59/64" x 8-21/32" x 15/16")
Weight: 110 g (Approx. 3 oz) (including batteries)

- For purposes of improvement, specifications and design are subject to change without notice.

Index

A

Accessories 2
 AM loop antenna 9
 Audio cable 9

B

BASS 12
 Bit rate 18, 20, 24
 Browse mode 19

C

Cable 8, 9
 Pin-plug cable 8
 Speaker cable 8
 Stereo pin-plug cable 9, 16
 Characters 15, 18, 21
 Connection 8, 9, 16
 Antenna 9
 Control dock for iPod 16
 iPod 16
 Power cord 10
 Recording component 9
 Speaker 8
 USB memory device 16
 Current time 11

D

Display 5
 Display's brightness 12
 Dynamic range 24

F

Finalize 24
 FM indoor antenna 9
 Front panel 4

H

Headphones 12

I

Input source 11

M

MP3 17, 18, 24
 Mute 12

P

Pin-plug cable 8
 Playback 13
 CD 13
 FM/AM broadcasts 15
 iPod 19
 MP3 18
 Portable audio player 20
 USB memory device 20
 WMA 18
 Protection circuit 8, 24

R

Rear panel 5
 Remote control 3, 6
 Batteries 3
 Remote mode 19
 Resetting the microprocessor 23

S

Sampling frequency 18, 20, 24
 SDB 12
 Speaker cable 8
 Speaker impedance 24
 Stereo pin-plug cable 9, 16
 Subwoofer 8

T

Timer 21
 Tone 12
 TREBLE 12

V

Volume 11

W

WMA 17, 18, 24

DENON

SPEAKER

SC-M37

Owner's Manual

Bedienungsanleitung

Manuel de l'Utilisateur

Manuale delle istruzioni

Manual del usuario

Gebruiksaanwijzing

Bruksanvisning

SAFETY PRECAUTIONS



CAUTION
RISK OF ELECTRIC SHOCK
DO NOT OPEN



CAUTION:
TO REDUCE THE RISK OF ELECTRIC SHOCK, DO NOT REMOVE COVER (OR BACK). NO USER-SERVICEABLE PARTS INSIDE. REFER SERVICING TO QUALIFIED SERVICE PERSONNEL.



The lightning flash with arrowhead symbol, within an equilateral triangle, is intended to alert the user to the presence of uninsulated "dangerous voltage" within the product's enclosure that may be of sufficient magnitude to constitute a risk of electric shock to persons.



The exclamation point within an equilateral triangle is intended to alert the user to the presence of important operating and maintenance (servicing) instructions in the literature accompanying the appliance.

WARNING:
TO REDUCE THE RISK OF FIRE OR ELECTRIC SHOCK, DO NOT EXPOSE THIS APPLIANCE TO RAIN OR MOISTURE.

For Europe model

• DECLARATION OF CONFORMITY

We declare under our sole responsibility that this product, to which this declaration relates, is in conformity with the following standards: EN55013 and EN55020. Following the provisions of 2004/108/EC Directive.

• ÜBEREINSTIMMUNGSERKLÄRUNG

Wir erklären unter unserer Verantwortung, daß dieses Produkt, auf das sich diese Erklärung bezieht, den folgenden Standards entspricht: EN55013 und EN55020. Entspricht den Verordnungen der Direktive 2004/108/EC.

• DECLARATION DE CONFORMITE

Nous déclarons sous notre seule responsabilité que l'appareil, auquel se réfère cette déclaration, est conforme aux standards suivants: EN55013 et EN55020. D'après les dispositions de la Directive 2004/108/EC.

• DICHIARAZIONE DI CONFORMITÀ

Dichiariamo con piena responsabilità che questo prodotto, al quale la nostra dichiarazione si riferisce, è conforme alle seguenti normative: EN55013 e EN55020. In conformità con le condizioni delle direttive 2004/108/EC.

• DECLARACIÓN DE CONFORMIDAD

Declaramos bajo nuestra exclusiva responsabilidad que este producto al que hace referencia esta declaración, está conforme con los siguientes estándares: EN55013 y EN55020. Siguiendo las provisiones de las Directivas 2004/108/EC.

• EENVORMIGHEIDSVERKLARING

Wij verklaren uitsluitend op onze verantwoordelijkheid dat dit product, waarop deze verklaring betrekking heeft, in overeenstemming is met de volgende normen: EN55013 en EN55020. Volgens de bepalingen van de Richtlijnen 2004/108/EC.

• ÖVERENSSTÄMMELSEINTYG

Härmed intygas helt på eget ansvar att denna produkt, vilken detta intyg avser, uppfyller följande standarder: EN55013 och EN55020. Enligt stadgarna i direktiv 2004/108/EC.

DENON Europe
 Division of D&M Germany GmbH
 An der Landwehr 19, Nettetal,
 D-41334 Germany

A NOTE ABOUT RECYCLING:

This product's packaging materials are recyclable and can be reused. Please dispose of any materials in accordance with the local recycling regulations. When discarding the unit, comply with local rules or regulations. Batteries should never be thrown away or incinerated but disposed of in accordance with the local regulations concerning chemical waste. This product and the accessories, packed together constitute the applicable product according to the WEEE directive except batteries.



HINWEIS ZUM RECYCLING:

Das Verpackungsmaterial dieses Produktes ist für zum Recyceln geeignet und kann wieder verwendet werden. Bitte entsorgen Sie alle Materialien entsprechend der örtlichen Recycling-Vorschriften. Beachten Sie bei der Entsorgung des Gerätes die örtlichen Vorschriften und Bestimmungen. Die Batterien dürfen nicht in den Hausmüll geworfen oder verbrannt werden; bitte geben Sie die Batterien gemäß örtlichen Bestimmungen an den Sammelstellen oder Sondermüllplätzen ab. Dieses Produkt zusammen mit den Zubehörteilen ist das geltende Produkt der WEEE-Direktive, davon ausgenommen sind die Batterien.

UNE REMARQUE CONCERNANT LE RECYCLAGE:

Les matériaux d'emballage de ce produit sont recyclables et peuvent être réutilisés. Veuillez disposer de tout matériau conformément aux règlements de recyclage locaux. Lorsque vous mettez cet appareil au rebut, respectez les lois ou réglementations locales. Les piles ne doivent jamais être jetées ou incinérées, mais mises au rebut conformément aux règlements locaux concernant les déchets chimiques. Ce produit et les accessoires emballés ensemble sont des produits conformes à la directive DEEE sauf pour les piles.

NOTA RELATIVA AL RICICLAGGIO:

I materiali di imballaggio di questo prodotto sono riutilizzabili e riciclabili. Smaltire i materiali conformemente alle normative locali sul riciclaggio. Per smaltire l'unità, osservare la normativa in vigore nel luogo di utilizzo. Non gettare le batterie, né incenerirle, ma smaltirle conformemente alla normativa locale sui rifiuti chimici. Questo prodotto e gli accessori inclusi nell'imballaggio sono applicabili alla direttiva RAEE, ad eccezione delle batterie.

ACERCA DEL RECICLAJE:

Los materiales de embalaje de este producto son reciclables y se pueden volver a utilizar. Disponga de estos materiales siguiendo los reglamentos de reciclaje de su localidad. Cuando se deshaga de la unidad, cumpla con las reglas o reglamentos locales. Las pilas nunca deberán tirarse ni incinerarse. Deberá disponer de ellas siguiendo los reglamentos de su localidad relacionados con los desperdicios químicos. Este producto junto con los accesorios empaquetados es el producto aplicable a la directiva RAEE excepto pilas.







EEN AANTEKENING WAT BETREFT HET RECYCLEREN:

Het inpakmateriaal van dit product is recycleerbaar en kan opnieuw gebruikt worden. Er wordt verzocht om zich van elk afvalmateriaal te ontdoen volgens de plaatselijke voorschriften. Volg voor het wegdoen van de speler de voorschriften voor de verwijdering van wit- en bruingoed op. Batterijen mogen nooit worden weggegooid of verbrand, maar moeten volgens de plaatselijke voorschriften betreffende chemisch afval worden verwijderd. Op dit product en de meegeleverde accessoires, m.u.v. de batterijen is de richtlijn voor afgedankte elektrische en elektronische apparaten (WEEE) van toepassing.

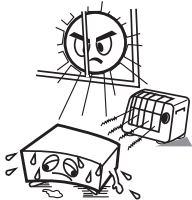
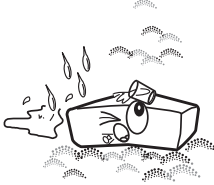
EN KOMMENTAR OM ÅTERVINNING:

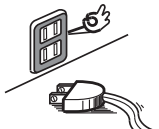
Produktens emballage är återvinningsbart och kan återanvändas. Kassera det enligt lokala återvinningsbestämmelser. När du kasserar enheten ska du göra det i överensstämmelse med lokala regler och bestämmelser. Batterier får absolut inte kastas i soporna eller brännas. Kassera dem enligt lokala bestämmelser för kemiskt avfall. Denna apparat och de tillbehör som levereras med den är de som uppfyller gällande WEEE-direktiv, med undantag av batterierna.

NOTE ON USE / HINWEISE ZUM GEBRAUCH / OBSERVATIONS RELATIVES A L'UTILISATION / NOTE SULL'USO / NOTAS SOBRE EL USO / ALVORENSTE GEBRUIKEN / OBSERVERA

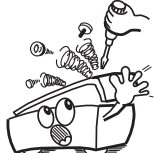
 <ul style="list-style-type: none"> • Avoid high temperatures. Allow for sufficient heat dispersion when installed in a rack. • Vermeiden Sie hohe Temperaturen. Beachten Sie, dass eine ausreichende Belüftung gewährleistet wird, wenn das Gerät auf ein Regal gestellt wird. • Eviter des températures élevées. Tenir compte d'une dispersion de chaleur suffisante lors de l'installation sur une étagère. • Evitate di esporre l'unità a temperature elevate. Assicuratevi che vi sia un'adeguata dispersione del calore quando installate l'unità in un mobile per componenti audio. • Evite altas temperaturas. Permite la suficiente dispersión del calor cuando está instalado en la consola. • Vermijd hoge temperaturen. Zorg voor een degelijke hitteafvoer indien het apparaat op een rek wordt geplaatst. • Undvik höga temperaturer. Se till att det finns möjlighet till god värmeavledning vid monteringen i ett rack. 	 <ul style="list-style-type: none"> • Keep the apparatus free from moisture, water, and dust. • Halten Sie das Gerät von Feuchtigkeit, Wasser und Staub fern. • Protéger l'appareil contre l'humidité, l'eau et la poussière. • Tenete l'unità lontana dall'umidità, dall'acqua e dalla polvere. • Mantenga el equipo libre de humedad, agua y polvo. • Laat geen vochtigheid, water of stof in het apparaat binnendringen. • Utsätt inte apparaten för fukt, vatten och damm. 	 <ul style="list-style-type: none"> • Do not let foreign objects into the set. • Keine fremden Gegenstände in das Gerät kommen lassen. • Ne pas laisser des objets étrangers dans l'appareil. • E' importante che nessun oggetto e inserito all'interno dell'unità. • No deje objetos extraños dentro del equipo. • Laat geen vreemde voorwerpen in dit apparaat vallen. • Se till att främmande föremål inte tränger in i apparaten. 	<p>CAUTION:</p> <ul style="list-style-type: none"> • The ventilation should not be impeded by covering the ventilation openings with items, such as newspapers, tablecloths, curtains, etc. • No naked flame sources, such as lighted candles, should be placed on the apparatus. • Attention should be drawn to the environmental aspects battery disposal. • Do not expose the set to dripping or splashing fluids. • No objects filled with liquids, such as vases, shall be placed on the apparatus. <p>ACHTUNG:</p> <ul style="list-style-type: none"> • Die Belüftung sollte auf keinen Fall durch das Abdecken der Belüftungsöffnungen durch Gegenstände wie beispielsweise Zeitungen, Tischtücher, Vorhänge o. Ä. behindert werden. • Auf dem Gerät sollten keinerlei direkte Feuerquellen wie beispielsweise angezündete Kerzen aufgestellt werden. • Bitte beachten Sie bei der Entsorgung der Batterien die geltenden Umweltbestimmungen. • Das Gerät sollte keiner tropfenden oder spritzenden Flüssigkeit ausgesetzt werden. • Auf dem Gerät sollten keinerlei mit Flüssigkeit gefüllten Behälter wie beispielsweise Vasen aufgestellt werden.
 <ul style="list-style-type: none"> • Handle the power cord carefully. Hold the plug when unplugging the cord. • Gehen Sie vorsichtig mit dem Netzkabel um. Halten Sie das Kabel am Stecker, wenn Sie den Stecker herausziehen. • Manipuler le cordon d'alimentation avec précaution. Tenir la prise lors du débranchement du cordon. • Maneggiare il filo di alimentazione con cura. Agire per la spina quando scollegate il cavo dalla presa. • Maneje el cordón de energía con cuidado. Sostenga el enchufe cuando desconecte el cordón de energía. • Hanteer het netsnoer voorzichtig. Houd het snoer bij de stekker vast wanneer deze moet worden aan- of losgekoppeld. • Hantera nätkabeln varsamt. Håll i kabeln när den kopplas från el-uttaget. 	 <ul style="list-style-type: none"> • Unplug the power cord when not using the apparatus for long periods of time. • Wenn das Gerät längere Zeit nicht verwendet werden soll, trennen Sie das Netzkabel vom Netzstecker. • Débrancher le cordon d'alimentation lorsque l'appareil n'est pas utilisé pendant de longues périodes. • Disinnestate il filo di alimentazione quando avete l'intenzione di non usare il filo di alimentazione per un lungo periodo di tempo. • Desconecte el cordón de energía cuando no utilice el equipo por mucho tiempo. • Neem altijd het netsnoer uit het stopcontact wanneer het apparaat gedurende een lange periode niet wordt gebruikt. • Koppla ur nätkabeln om apparaten inte kommer att användas i lång tid. 	 <ul style="list-style-type: none"> • Do not let insecticides, benzene, and thinner come in contact with the apparatus. • Lassen Sie das Gerät nicht mit Insektiziden, Benzin oder Verdünnungsmitteln in Berührung kommen. • Ne pas mettre en contact des insecticides, du benzène et un diluant avec l'appareil. • Assicuratevi che l'unità non venga in contatto con insetticidi, benzolo o solventi. • No permita el contacto de insecticidas, gasolina y diluyentes con el equipo. • Laat geen insektenverdelgende middelen, benzine of ververdunner met dit apparaat in contact komen. • Se till att inte insektsmedel på spraybruk, bensin och thinner kommer i kontakt med apparatens hölje. 	<p>ATTENTION :</p> <ul style="list-style-type: none"> • La ventilation ne doit pas être gênée en recouvrant les ouvertures de la ventilation avec des objets tels que journaux, rideaux, tissus, etc. • Aucune flamme nue, par exemple une bougie, ne doit être placée sur l'appareil. • Veillez à respecter l'environnement lorsque vous jetez les piles usagées. • L'appareil ne doit pas être exposé à l'eau ou à l'humidité. • Aucun objet conten ant du liquide, par exemple un vase, ne doit être placé sur l'appareil. <p>PRECAUZIONI:</p> <ul style="list-style-type: none"> • Le aperture di ventilazione non devono essere ostruite coprendole con oggetti, quali giornali, tovaglie, tende e così via. • Non posizionate sull'unità fiamme libere, come ad esempio le candele accese. • Prestate attenzione agli aspetti legati alla tutela dell'ambiente quando si smaltisce la batterie. • L'apparecchiatura non deve essere esposta a gocciolii o spruzzi. • Non posizionate sull'apparecchiatura nessun oggetto contenente liquidi, come ad esempio i vasi. <p>PRECAUCIÓN:</p> <ul style="list-style-type: none"> • La ventilación no debe quedar obstruida por haberse cubierto las aperturas con objetos como periódicos, manteles, cortinas, etc. • No debe colocarse sobre el aparato ninguna fuente inflamable sin protección, como velas encendidas. • A la hora de deshacerse de las pilas, respete la normativa para el cuidado del medio ambiente. • No expondrá el aparato al goteo o salpicaduras cuando se utilice. • No se colocarán sobre el aparato objetos llenos de líquido, como jarros.
 <p>* (For apparatuses with ventilation holes)</p> <ul style="list-style-type: none"> • Do not obstruct the ventilation holes. • Die Belüftungsöffnungen dürfen nicht verdeckt werden. • Ne pas obstruer les trous d'aération. • Non coprite i fori di ventilazione. • No obstruya los orificios de ventilación. • De ventilatieopeningen mogen niet worden beblokkeerd. • Täpp inte till ventilationsöppningarna. 	 <p>* (For apparatuses with ventilation holes)</p> <ul style="list-style-type: none"> • Do not obstruct the ventilation holes. • Die Belüftungsöffnungen dürfen nicht verdeckt werden. • Ne pas obstruer les trous d'aération. • Non coprite i fori di ventilazione. • No obstruya los orificios de ventilación. • De ventilatieopeningen mogen niet worden beblokkeerd. • Täpp inte till ventilationsöppningarna. 	 <ul style="list-style-type: none"> • Never disassemble or modify the apparatus in any way. • Versuchen Sie niemals das Gerät auseinander zu nehmen oder auf jegliche Art zu verändern. • Ne jamais démonte ou modifiez l'appareil d'une manière ou d'une autre. • Non smontate mai, né modificate l'unità in nessun modo. • Nunca desarme o modifique el equipo de ninguna manera. • Nocit dit apparaat demonteren of op andere wijze modifieren. • Ta inte isär apparaten och försök inte bygga om den. 	<p>WAARSCHUWING:</p> <ul style="list-style-type: none"> • De ventilatie mag niet worden belemmerd door de ventilatieopeningen af te decken met bijvoorbeeld kranten, een tafelkleed, gordijnen, enz. • Plaats geen open vlammen, bijvoorbeeld een brandende kaars, op het apparaat. • Houd u steeds aan de milieuvorschriften wanneer u gebruikte batterijen wegdoet. • Stel het apparaat niet bloot aan druppels of spatten. • Plaats geen voorwerpen gevuld met water, bijvoorbeeld een vaas, op het apparaat. <p>OBSERVERA:</p> <ul style="list-style-type: none"> • Ventilationen bör inte förhindras genom att täcka för ventilationsöppningarna med föremål såsom tidningar, bordsdukar, gardiner osv. • Inga blottade brandkällor, såsom tända ljus, bör placeras på apparaten. • Tänk på miljöaspekterna när du bortskaffar batteri. • Apparaten får inte utsättas för vätska. • Inga objekt med vätskor, såsom vaser, får placeras på apparaten.

Contents

Getting Started

Accessories	1
Before Using	1
Cautions on Installation.....	1
Acoustic Sponge.....	2
How to Install.....	2
Cleaning.....	2
Other Cautions.....	2

Connections

Connections	3
--------------------------	---

Removing the Speaker Net	3
---------------------------------------	---

Specifications	4
-----------------------------	---

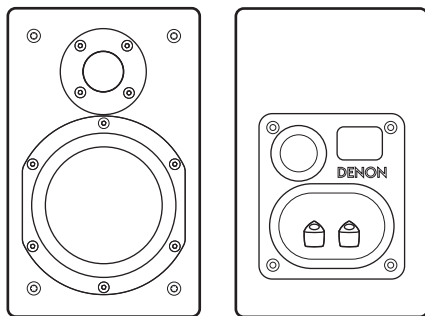

[Front]

[Rear]



Note that the illustrations in this instructions may differ from the actual set for explanation purposes.

Getting Started

Thank you for purchasing this DENON product. To ensure proper operation, please read this owner's manual carefully before using the product.

After reading them, be sure to keep them for future reference.

Accessories

Check that the following parts are attached in addition to the main unit:

① Owner's Manual.....	1
② Service station list.....	1
③ Speaker cable (Approx. 9.8 ft / 3 m).....	2
④ Foam plug.....	2
⑤ Anti-slip pads (8 pcs. / 1 sheet).....	1

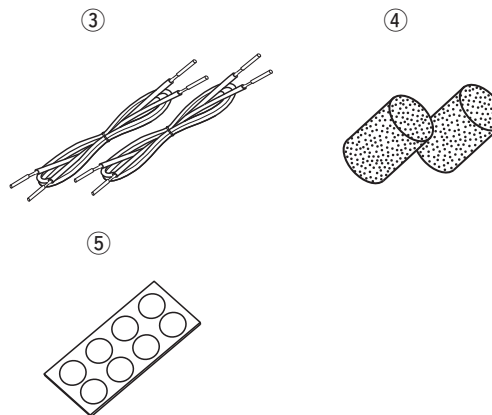

Before Using

Cautions on Installation

The quality of the sound produced from the speaker is affected by the size and type of the room, as well as by the method of installation. Consider the points listed below before installing the speaker.

- If the bass sound is overemphasized when the speakers are installed directly on the floor, set them on concrete blocks or other hard stands.
- Note that placing the speaker on the same stand or shelf as a record player may result in howling.
- Also note that if there is a magnet or any device generating magnetic force nearby, interaction between this device and the speakers can cause the colors on the TV to become blotchy.

WARNING

- Fasten the speaker cables to the wall, etc., to avoid catching them on your hands or feet and causing the unit to fall.
- Be sure to check for safety after installing the speakers. Afterwards, perform safety inspections at regular intervals to make sure there at the speakers will fall.
DENON will accept no responsibility for damages or accidents caused by inappropriate choice of the place of installation or improper installation procedures.

Acoustic Sponge

When installing on a desktop or in the corner of your room, the bass may be emphasized. Insert sound foam plug in the bass-reflex duct at the back of the SC-M37.

You can adjust the bass sound with the amount of sound foam plug you insert.

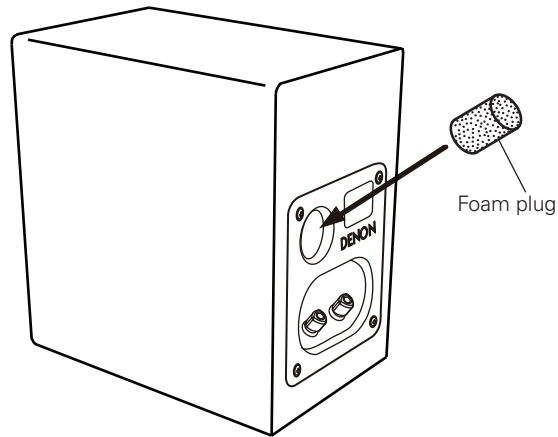

CAUTION

- Do not insert the foam plug too deep. The foam plug could fall in and get stuck inside.
- If the foam plug cannot be removed or falls inside, stop using the unit immediately and consult your store of purchase or your nearest repair and inquiry center.

How to Install

Attach four of the included anti-slip pads to the bottom of the unit as shown on the diagram below.

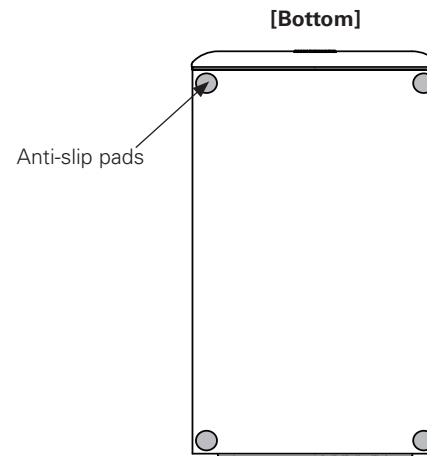

Cleaning

- Use a wiping cloth and wipe lightly to remove dirt from the cabinet and operation panel.
- ※ When using chemically treated cloths, follow the precautions that have been written for them.
- Do not use benzene, thinners, or other organic solvents or insecticides on the main unit since they may cause a change in quality or color.

Other Cautions

- Raising the amplifier's volume excessively and playing with distorted sound could damage the amplifier and speakers. Enjoy the sound at a reasonable volume level.
- When moving the unit, note that applying strong force to the surface of the speaker through the saran net could damage the speaker.

Connections

When connecting, be sure to read the amplifier's owner's manual carefully and connect properly.

- Connect the input terminals on the rear panel of the speaker with the speaker output terminals on the amplifier, using the speaker cables (Supplied).
- Connect the speaker for the left channel to the "L" terminal on the amplifier, the speaker for the right channel to the "R" terminal on the amplifier, making sure to check the polarities ("+" and "-").
- There are various types of speaker output terminals on amplifiers. Check your amplifier's owner's manual.

CAUTION

- Be sure to turn the amplifier's power off before connecting the speakers to the amplifier.
- If the polarities are inverted, the phase may be off and the sound may have no bass component, making it seem unnatural. Be sure to connect the polarities properly.

Connections

Use the included speaker cable to connect the input terminals on the back of the speakers to the amplifier's speaker output terminals.

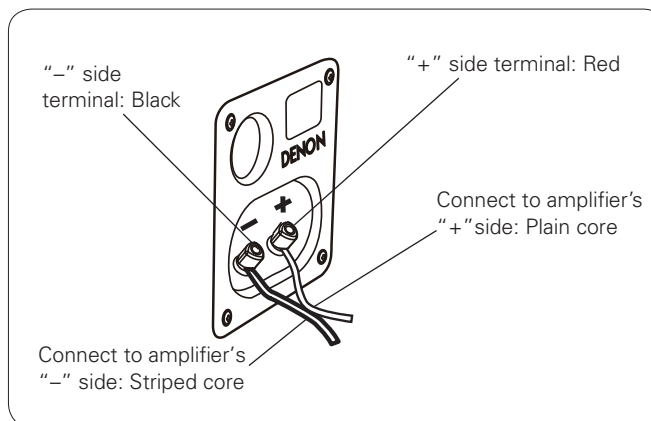

- 1 Twist firmly the wires by hand so that they do not stick out and cause short-circuits.**

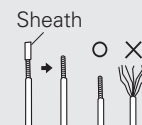

- 2 Loosen the terminal by turning to the left and insert the speaker cable through the hole in the speaker terminal.**

- 3 Tighten the terminal by turning to the right and check that the core wire is not protruding from the hole.**



Once connections are completed, pull gently on the speaker cables to check that they are securely connected.

CAUTION

Do not let the core wires of two speaker cables touch each other. Doing so will short-circuit the amplifier circuitry and damage the amplifier.

Removing the Speaker Net

- The net on the front of the speakers can be removed.
- To remove, grasp both sides of the net and pull forward.
- To mount, line up the projecting pieces in the four corners of the speaker net with the holes in the four corners of the cabinet and press in.

Specifications

Type:	2-way · 2-speakers Low-leakage-flux, Reflex box
Frequency range:	45 Hz ~ 40 kHz
Input impedance:	6 Ω/ohms
Max. input:	60 W (IEC), 120 W (PEAK)
Sensitivity:	86 dB (1 W · 1 m)
Crossover frequency:	3 kHz
Speakers:	12 cm (4-3/4") cone bass-mid x 1 2.5 cm (1") soft dome high range x 1
Maximum external dimensions:	145 (W) x 233 (H) x 234 (D) mm (5-45/64" x 9-11/64" x 9-7/32")
Weight:	3.8 kg (8 lbs 6 oz)

※ For improvement purposes, specifications and design are subject to change without notice.

DENON

www.denon.com

D&M Holdings Inc.
Printed in China 5411 10457 004D

Free Manuals Download Website

<http://myh66.com>

<http://usermanuals.us>

<http://www.somanuals.com>

<http://www.4manuals.cc>

<http://www.manual-lib.com>

<http://www.404manual.com>

<http://www.luxmanual.com>

<http://aubethermostatmanual.com>

Golf course search by state

<http://golfingnear.com>

Email search by domain

<http://emailbydomain.com>

Auto manuals search

<http://auto.somanuals.com>

TV manuals search

<http://tv.somanuals.com>