

DENON

SPEAKER

SC-CX101

Owner's Manual

Bedienungsanleitung

Manuel de l'Utilisateur

Manuale delle istruzioni

Manual del usuario

Gebruiksaanwijzing

Bruksanvisning

SAFETY PRECAUTIONS



CAUTION
RISK OF ELECTRIC SHOCK
DO NOT OPEN



CAUTION:
TO REDUCE THE RISK OF ELECTRIC SHOCK, DO NOT REMOVE COVER (OR BACK). NO USER-SERVICEABLE PARTS INSIDE. REFER SERVICING TO QUALIFIED SERVICE PERSONNEL.

The lightning flash with arrowhead symbol, within an equilateral triangle, is intended to alert the user to the presence of uninsulated "dangerous voltage" within the product's enclosure that may be of sufficient magnitude to constitute a risk of electric shock to persons.

The exclamation point within an equilateral triangle is intended to alert the user to the presence of important operating and maintenance (servicing) instructions in the literature accompanying the appliance.

WARNING:
TO REDUCE THE RISK OF FIRE OR ELECTRIC SHOCK, DO NOT EXPOSE THIS APPLIANCE TO RAIN OR MOISTURE.

- **DECLARATION OF CONFORMITY**
 We declare under our sole responsibility that this product, to which this declaration relates, is in conformity with the following standards: EN55013 and EN55020.
 Following the provisions of 2004/108/EC Directive.
- **ÜBEREINSTIMMUNGSERKLÄRUNG**
 Wir erklären unter unserer Verantwortung, daß dieses Produkt, auf das sich diese Erklärung bezieht, den folgenden Standards entspricht: EN55013 und EN55020.
 Entspricht den Verordnungen der Direktive 2004/108/EC.
- **DECLARATION DE CONFORMITE**
 Nous déclarons sous notre seule responsabilité que l'appareil, auquel se réfère cette déclaration, est conforme aux standards suivants: EN55013 et EN55020.
 D'après les dispositions de la Directive 2004/108/EC.
- **DICHIARAZIONE DI CONFORMITÀ**
 Dichiariamo con piena responsabilità che questo prodotto, al quale la nostra dichiarazione si riferisce, è conforme alle seguenti normative: EN55013 e EN55020.
 In conformità con le condizioni delle direttive 2004/108/EC.
- **DECLARACIÓN DE CONFORMIDAD**
 Declaramos bajo nuestra exclusiva responsabilidad que este producto al que hace referencia esta declaración, está conforme con los siguientes estándares: EN55013 y EN55020.
 Siguiendo las provisiones de las Directivas 2004/108/EC.
- **EENVORMIGHEIDSVRKLARING**
 Wij verklaren uitsluitend op onze verantwoordelijkheid dat dit product, waarop deze verklaring betrekking heeft, in overeenstemming is met de volgende normen: EN55013 en EN55020.
 Volgens de bepalingen van de Richtlijnen 2004/108/EC.
- **ÖVERENSSTÄMMELSEINTYG**
 Härmed intygas helt på eget ansvar att denna produkt, vilken detta intyg avser, uppfyller följande standarder: EN55013 och EN55020.
 Enligt stadgarna i direktiv 2004/108/EC.

DENON Europe
 Division of D&M Germany GmbH
 An der Landwehr 19, Nettetal,
 D-41334 Germany

A NOTE ABOUT RECYCLING:
 This product's packaging materials are recyclable and can be reused. Please dispose of any materials in accordance with the local recycling regulations.
 When discarding the unit, comply with local rules or regulations.
 Batteries should never be thrown away or incinerated but disposed of in accordance with the local regulations concerning chemical waste.
 This product and the accessories, packed together constitute the applicable product according to the WEEE directive except batteries.

HINWEIS ZUM RECYCLING:
 Das Verpackungsmaterial dieses Produktes ist für zum Recyceln geeignet und kann wieder verwendet werden. Bitte entsorgen Sie alle Materialien entsprechend der örtlichen Recycling-Vorschriften.
 Beachten Sie bei der Entsorgung des Gerätes die örtlichen Vorschriften und Bestimmungen.
 Die Batterien dürfen nicht in den Hausmüll geworfen oder verbrannt werden; bitte geben Sie die Batterien gemäß örtlichen Bestimmungen an den Sammelstellen oder Sondermüllplätzen ab.
 Dieses Produkt zusammen mit den Zubehörteilen ist das geltende Produkt der WEEE-Direktive, davon ausgenommen sind die Batterien.

UNE REMARQUE CONCERNANT LE RECYCLAGE:
 Les matériaux d'emballage de ce produit sont recyclables et peuvent être réutilisés. Veuillez disposer de tout matériau conformément aux règlements de recyclage locaux.
 Lorsque vous mettez cet appareil au rebut, respectez les lois ou réglementations locales.
 Les piles ne doivent jamais être jetées ou incinérées, mais mises au rebut conformément aux règlements locaux concernant les déchets chimiques.
 Ce produit et les accessoires emballés ensemble sont des produits conformes à la directive DEEE sauf pour les piles.







NOTA RELATIVA AL RICICLAGGIO:
 I materiali di imballaggio di questo prodotto sono riutilizzabili e riciclabili. Smaltire i materiali conformemente alle normative locali sul riciclaggio.
 Per smaltire l'unità, osservare la normativa in vigore nel luogo di utilizzo.
 Non gettare le batterie, né incenerirle, ma smaltirle conformemente alla normativa locale sui rifiuti chimici.
 Questo prodotto e gli accessori inclusi nell'imballaggio sono applicabili alla direttiva RAEE, ad eccezione delle batterie.

ACERCA DEL RECICLAJE:
 Los materiales de embalaje de este producto son reciclables y se pueden volver a utilizar. Disponga de estos materiales siguiendo los reglamentos de reciclaje de su localidad.
 Cuando se deshaga de la unidad, cumpla con las reglas o reglamentos locales.
 Las pilas nunca deberán tirarse ni incinerarse. Deberá disponer de ellas siguiendo los reglamentos de su localidad relacionados con los desperdicios químicos.
 Este producto junto con los accesorios empaquetados es el producto aplicable a la directiva RAEE excepto pilas.

EEN AANTEKENING WAT BETREFT HET RECYCLEREN:
 Het inpakmateriaal van dit product is recycleerbaar en kan opnieuw gebruikt worden. Er wordt verzocht om zich van elk afvalmateriaal te ontdoen volgens de plaatselijke voorschriften.
 Volg voor het wegdoen van de speler de voorschriften voor de verwijdering van wit- en bruingoed op.
 Batterijen mogen nooit worden weggegooid of verbrand, maar moeten volgens de plaatselijke voorschriften betreffende chemisch afval worden verwijderd.
 Op dit product en de meegeleverde accessoires, m.u.v. de batterijen is de richtlijn voor afgedankte elektrische en elektronische apparaten (WEEE) van toepassing.

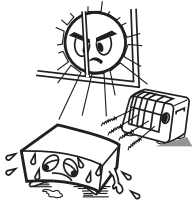
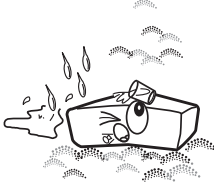
EN KOMMENTAR OM ÅTERVINNING:
 Produktens emballage är återvinningsbart och kan återanvändas. Kassera det enligt lokala återvinningsbestämmelser.
 När du kasserar enheten ska du göra det i överensstämmelse med lokala regler och bestämmelser.
 Batterier får absolut inte kastas i soporna eller brännas. Kassera dem enligt lokala bestämmelser för kemiskt avfall.
 Denna apparat och de tillbehör som levereras med den är de som uppfyller gällande WEEE-direktiv, med undantag av batterierna.

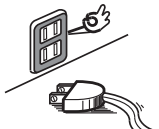
NOTE ON USE / HINWEISE ZUM GEBRAUCH / OBSERVATIONS RELATIVES A L'UTILISATION / NOTE SULL'USO / NOTAS SOBRE EL USO / ALVORENSTE GEBRUIKEN / OBSERVERA

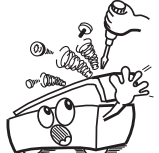
 <ul style="list-style-type: none"> • Avoid high temperatures. Allow for sufficient heat dispersion when installed in a rack. • Vermeiden Sie hohe Temperaturen. Beachten Sie, dass eine ausreichende Belüftung gewährleistet wird, wenn das Gerät auf ein Regal gestellt wird. • Eviter des températures élevées. Tenir compte d'une dispersion de chaleur suffisante lors de l'installation sur une étagère. • Evitate di esporre l'unità a temperature elevate. Assicuratevi che vi sia un'adeguata dispersione del calore quando installate l'unità in un mobile per componenti audio. • Evite altas temperaturas. Permite la suficiente dispersión del calor cuando está instalado en la consola. • Vermijd hoge temperaturen. Zorg voor een degelijke hitteafvoer indien het apparaat op een rek wordt geplaatst. • Undvik höga temperaturer. Se till att det finns möjlighet till god värmeavledning vid montering i ett rack. 	 <ul style="list-style-type: none"> • Keep the apparatus free from moisture, water, and dust. • Halten Sie das Gerät von Feuchtigkeit, Wasser und Staub fern. • Protéger l'appareil contre l'humidité, l'eau et la poussière. • Tenete l'unità lontana dall'umidità, dall'acqua e dalla polvere. • Mantenga el equipo libre de humedad, agua y polvo. • Laat geen vochtigheid, water of stof in het apparaat binnendringen. • Utsätt inte apparaten för fukt, vatten och damm. 	 <ul style="list-style-type: none"> • Do not let foreign objects into the set. • Keine fremden Gegenstände in das Gerät kommen lassen. • Ne pas laisser des objets étrangers dans l'appareil. • E' importante che nessun oggetto e inserito all'interno dell'unità. • No deje objetos extraños dentro del equipo. • Laat geen vreemde voorwerpen in dit apparaat vallen. • Se till att främmande föremål inte tränger in i apparaten. 	<p>CAUTION:</p> <ul style="list-style-type: none"> • The ventilation should not be impeded by covering the ventilation openings with items, such as newspapers, tablecloths, curtains, etc. • No naked flame sources, such as lighted candles, should be placed on the apparatus. • Attention should be drawn to the environmental aspects battery disposal. • Do not expose the set to dripping or splashing fluids. • No objects filled with liquids, such as vases, shall be placed on the apparatus. <p>ACHTUNG:</p> <ul style="list-style-type: none"> • Die Belüftung sollte auf keinen Fall durch das Abdecken der Belüftungsöffnungen durch Gegenstände wie beispielsweise Zeitungen, Tischtücher, Vorhänge o. Ä. behindert werden. • Auf dem Gerät sollten keinerlei direkte Feuerquellen wie beispielsweise angezündete Kerzen aufgestellt werden. • Bitte beachten Sie bei der Entsorgung der Batterien die geltenden Umweltbestimmungen. • Das Gerät sollte keiner tropfenden oder spritzenden Flüssigkeit ausgesetzt werden. • Auf dem Gerät sollten keinerlei mit Flüssigkeit gefüllten Behälter wie beispielsweise Vasen aufgestellt werden.
 <ul style="list-style-type: none"> • Handle the power cord carefully. Hold the plug when unplugging the cord. • Gehen Sie vorsichtig mit dem Netzkabel um. Halten Sie das Kabel am Stecker, wenn Sie den Stecker herausziehen. • Manipuler le cordon d'alimentation avec précaution. Tenir la prise lors du débranchement du cordon. • Maneggiare il filo di alimentazione con cura. Agire per la spina quando scollegate il cavo dalla presa. • Maneje el cordón de energía con cuidado. Sostenga el enchufe cuando desconecte el cordón de energía. • Hanteer het netsnoer voorzichtig. Houd het snoer bij de stekker vast wanneer deze moet worden aan- of losgekoppeld. • Hantera nätkabeln varsamt. Håll i kabeln när den kopplas från el-uttaget. 	 <ul style="list-style-type: none"> • Unplug the power cord when not using the apparatus for long periods of time. • Wenn das Gerät längere Zeit nicht verwendet werden soll, trennen Sie das Netzkabel vom Netzstecker. • Débrancher le cordon d'alimentation lorsque l'appareil n'est pas utilisé pendant de longues périodes. • Disinnestate il filo di alimentazione quando avete l'intenzione di non usare il filo di alimentazione per un lungo periodo di tempo. • Desconecte el cordón de energía cuando no utilice el equipo por mucho tiempo. • Neem altijd het netsnoer uit het stopkontakt wanneer het apparaat gedurende een lange periode niet wordt gebruikt. • Koppla ur nätkabeln om apparaten inte kommer att användas i lång tid. 	 <ul style="list-style-type: none"> • Do not let insecticides, benzene, and thinner come in contact with the apparatus. • Lassen Sie das Gerät nicht mit Insektiziden, Benzin oder Verdünnungsmitteln in Berührung kommen. • Ne pas mettre en contact des insecticides, du benzène et un diluant avec l'appareil. • Assicuratevi che l'unità non venga in contatto con insetticidi, benzolo o solventi. • No permita el contacto de insecticidas, gasolina y diluyentes con el equipo. • Laat geen insectenverdelgende middelen, benzine of ververdunner met dit apparaat in contact komen. • Se till att inte insektsmedel på spraybruk, bensen och thinner kommer i kontakt med apparatens hölje. 	<p>ATTENTION :</p> <ul style="list-style-type: none"> • La ventilation ne doit pas être gênée en recouvrant les ouvertures de la ventilation avec des objets tels que journaux, rideaux, tissus, etc. • Aucune flamme nue, par exemple une bougie, ne doit être placée sur l'appareil. • Veillez à respecter l'environnement lorsque vous jetez les piles usagées. • L'appareil ne doit pas être exposé à l'eau ou à l'humidité. • Aucun objet conten ant du liquide, par exemple un vase, ne doit être placé sur l'appareil. <p>PRECAUZIONI:</p> <ul style="list-style-type: none"> • Le aperture di ventilazione non devono essere ostruite coprendole con oggetti, quali giornali, tovaglie, tende e così via. • Non posizionate sull'unità fiamme libere, come ad esempio le candele accese. • Prestate attenzione agli aspetti legati alla tutela dell'ambiente quando si smaltisce la batterie. • L'apparecchiatura non deve essere esposta a gocciolii o spruzzi. • Non posizionate sull'apparecchiatura nessun oggetto contenente liquidi, come ad esempio i vasi. <p>PRECAUCIÓN:</p> <ul style="list-style-type: none"> • La ventilación no debe quedar obstruida por haberse cubierto las aperturas con objetos como periódicos, manteles, cortinas, etc. • No debe colocarse sobre el aparato ninguna fuente inflamable sin protección, como velas encendidas. • A la hora de deshacerse de las pilas, respete la normativa para el cuidado del medio ambiente. • No expondrá el aparato al goteo o salpicaduras cuando se utilice. • No se colocarán sobre el aparato objetos llenos de líquido, como jarros.
 <p>* (For apparatuses with ventilation holes)</p> <ul style="list-style-type: none"> • Do not obstruct the ventilation holes. • Die Belüftungsöffnungen dürfen nicht verdeckt werden. • Ne pas obstruer les trous d'aération. • Non coprite i fori di ventilazione. • No obstruya los orificios de ventilación. • De ventilatieopeningen mogen niet worden beblokkeerd. • Täpp inte till ventilationsöppningarna. 	 <ul style="list-style-type: none"> • Never disassemble or modify the apparatus in any way. • Versuchen Sie niemals das Gerät auseinander zu nehmen oder auf jegliche Art zu verändern. • Ne jamais démonte ou modifiez l'appareil d'une manière ou d'une autre. • Non smontate mai, né modificate l'unità in nessun modo. • Nunca desarme o modifique el equipo de ninguna manera. • Nocit dit apparaat demonteren of op andere wijze modifieren. • Ta inte isär apparaten och försök inte bygga om den. 	<p>WAARSCHUWING:</p> <ul style="list-style-type: none"> • De ventilatie mag niet worden belemmerd door de ventilatieopeningen af te decken met bijvoorbeeld kranten, een tafelkleed, gordijnen, enz. • Plaats geen open vlammen, bijvoorbeeld een brandende kaars, op het apparaat. • Houd u steeds aan de milieuvorschriften wanneer u gebruikte batterijen wegdoet. • Stel het apparaat niet bloot aan druppels of spatten. • Plaats geen voorwerpen gevuld met water, bijvoorbeeld een vaas, op het apparaat. <p>OBSERVERA:</p> <ul style="list-style-type: none"> • Ventilationen bör inte förhindras genom att täcka för ventilationsöppningarna med föremål såsom tidningar, bordsdukar, gardiner osv. • Inga blottade brandkällor, såsom tända ljus, bör placeras på apparaten. • Tänk på miljöaspekterna när du bortskaffar batteri. • Apparaten får inte utsättas för vätska. • Inga objekt med vätskor, såsom vaser, får placeras på apparaten. 	

Contents

Getting Started	
Accessories	1
Before Using	
Cautions on Installation.....	1
External Finish.....	2
Moving the Unit.....	2
Cleaning.....	2
Other Cautions.....	2
Connections	
Normal Connections	2
Bi-wiring Connections	3
Removing the Speaker Net 3	
About the Ventilation Holes 3	
Specifications 4	

Getting Started

Thank you for purchasing this DENON product. To ensure proper operation, please read these owner's manual carefully before using the product.

After reading them, be sure to keep them for future reference.

Accessories

Check that the following parts are attached in addition to the main unit:

- ① Owner's Manual 1
- ② Service station list 1
- ③ Speaker cable (Approx. 3 m)..... 2
- ④ Foam plug..... 2
- ⑤ Anti-slip pads (8 pcs. / 1 sheet) 1

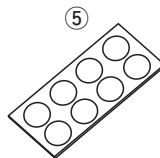
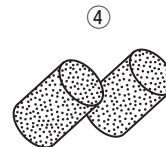
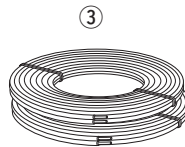

Before using

Cautions on installation

The quality of the sound produced from the speaker is affected by the size and type of the room, as well as by the method of installation. Consider the points listed below before installing the speaker.

- If the bass sound is overemphasized when the speakers are installed directly on the floor, set them on concrete blocks or other hard stands.
- Placing the speakers on a shelf or in a corner can boost the bass level of the speaker. If you want to reduce it, please place the foam plugs in the reflex port tubes that you can find on the back of the speakers.
- Do not insert the foam plug too deep. The foam plug could fall in and get stuck inside.
- If the foam plug cannot be removed or falls inside, stop using the unit immediately and consult your store of purchase or your nearest repair and inquiry center.
- Note that placing the speaker on the same stand or shelf as a record player may result in howling.
- Also note that if there is a magnet or any device generating magnetic force nearby, interaction between this device and the speakers can cause the colors on the TV to become blotchy.
- For increased safety, when installing the unit, attach four of the included anti-slip pads to the bottom of the unit as shown on the diagram below.

[Bottom view]

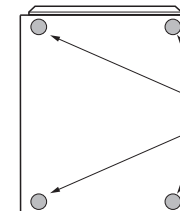

Attach the anti-slip pads here

WARNING

Fasten the speaker cables to the wall, etc., to avoid catching them on your hands or feet and causing the unit to fall.

External Finish

The surface of the set's cabinet uses parts made from natural wood. The colors and patterns are thus natural and unique to each set. Note that the surface is coated and finished based on DENON's strict quality standards so the set can be used without worry.

Moving the Unit

- Do not shock this unit.
- Always check that the speaker cables disconnected before moving this unit.

Cleaning

- Use a wiping cloth and wipe lightly to remove dirt from the cabinet and operation panel.
- When using chemically treated cloths, follow the precautions that have been written for them.
- Do not use benzene, thinners, or other organic solvents or insecticides on the main unit since they may cause a change in quality or color.

Other Cautions

- There are various types of speaker output terminals on amplifiers. Check your amplifier's owner's manual.
- Raising the amplifier's volume excessively and playing with distorted sound could damage the amplifier and speakers. Enjoy the sound at a reasonable volume level.
- When moving the unit, note that applying strong force to the surface of the speaker through the saran net could damage the speaker.



Note that the illustrations in this instructions may differ from the actual set for explanation purposes.

Connections

When connecting, be sure to read the amplifier's owner's manual carefully and connect properly.

- Connect the input terminals on the rear panel of the speaker with the speaker output terminals on the amplifier, using the speaker cables (Supplied).
- Connect the speaker for the left channel to the "L" terminal on the amplifier, the speaker for the right channel to the "R" terminal on the amplifier, making sure to check the polarities ("+" and "-").



Once connections are completed, check that all of the short-circuiting cords are securely connected to the terminals ("+" to "+", "-" to "-") on the woofer and tweeter sides).

CAUTION

- Be sure to turn the amplifier's power off before connecting the speakers to the amplifier.
- If the polarities are inverted, the phase may be off and the sound may have no bass component, making it seem unnatural. Be sure to connect the polarities properly.

Normal Connections

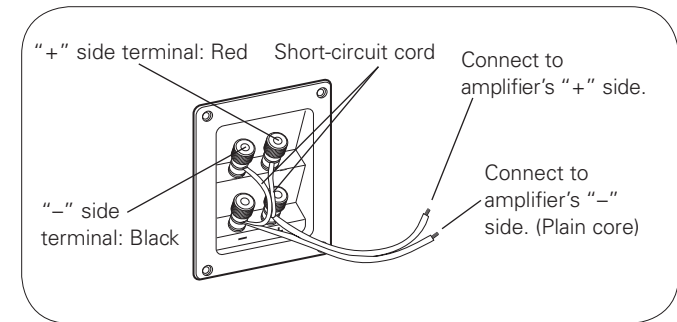

- 1 Twist firmly the wires by hand so that they do not stick out and cause short-circuits.**

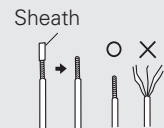

- 2 Loosen the terminal, insert the cord's core wire into the hole in the terminal, then turn the terminal clockwise to tighten it.**

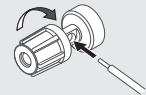

- 3 Even if nothing is connected to a terminal, turn it clockwise to tighten the short-circuit cord.**



- Once connections are completed, pull gently on the speaker cables to check that they are securely connected.
- The speaker cables can also be connected to the terminals using the included banana plugs.

CAUTION

Do not let the core wires of two speaker cables touch each other. Doing so will short-circuit the amplifier circuitry and damage the amplifier.

Bi-wiring Connections

The speaker (SC-CX101) input terminals and circuitry allows bi-wiring connections with the treble (upper tier) and bass (lower tier) isolated and independent. This enables playback of high quality sound without the audio signal interference resulting from the difference in level between the treble and bass.

※ Use two speaker cables per SC-CX101 unit.

※ Remove the short-circuit cords from the "+" and "-" sides.

Connecting to an amplifier with two sets of speaker outputs (A+B)

Set the speaker output selector switch to "A+B".

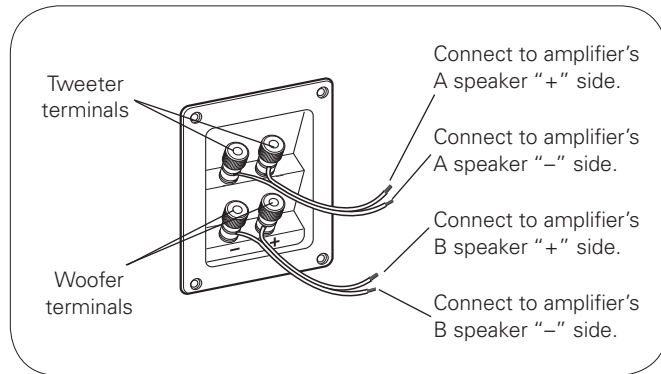

Connecting to an amplifier with only one set of speaker outputs

Also use this procedure to connect to amplifiers on which it is not possible to output A and B simultaneously even if the amplifier has two sets of outputs, or amplifiers on which the two sets of outputs are connected in series.

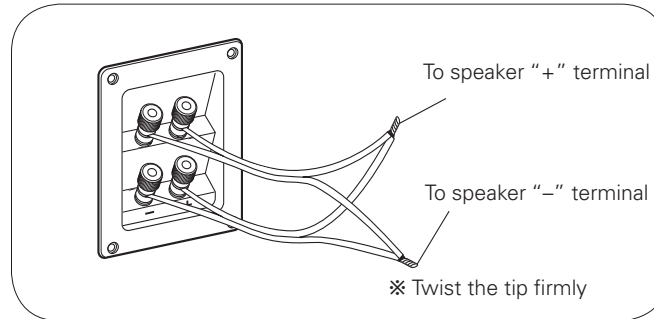

- The SC-CX101's impedance does not change even when using with bi-wiring connections.
- For even more advanced enjoyment, if you have two amplifiers you can set up a bi-amp drive system. In this case, set the outputs of the two amplifiers to the same level.

CAUTION

If the amplifiers have different output levels, only the treble or the bass will be emphasized and it will be impossible to achieve the optimum balance between the two.

Removing the Speaker Net

The net on the front of the speakers can be removed.

To remove, grasp both sides of the net and pull forward.

※ To mount, line up the projecting pieces in the four corners of the speaker net with the holes in the four corners of the cabinet and press in.

About the Ventilation Holes

Two ventilation holes are provided in the tweeter dome and edge to prevent warping of the diaphragm due to thermal expansion of the air in the tweeter dome.

※ The holes are normal and do not indicate damage.

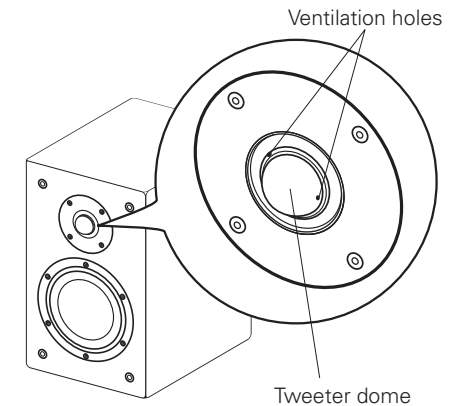

Specifications

Type:	2-way · 2-speakers Low-leakage-flux, Reflex box
Speakers:	12 cm cone bass-mid x 1 2.5 cm soft dome high range x 1
Input impedance:	6 Ω /ohms
Max. input:	60 W (IEC) 120 W (PEAK)
Crossover frequency:	3 kHz
Frequency range:	45 Hz ~ 40 kHz
Sensitivity:	86 dB (1 W · 1 m)
Maximum external dimensions:	157 (W) x 257 (H) x 234 (D) mm (Including protruding parts)
Weight:	5.2 kg

※ For improvement purposes, specifications and design are subject to change without notice.

DENON

www.denon.com

Denon Brand Company, D&M Holdings Inc.
Printed in China 5411 10025 001D

Free Manuals Download Website

<http://myh66.com>

<http://usermanuals.us>

<http://www.somanuals.com>

<http://www.4manuals.cc>

<http://www.manual-lib.com>

<http://www.404manual.com>

<http://www.luxmanual.com>

<http://aubethermostatmanual.com>

Golf course search by state

<http://golfingnear.com>

Email search by domain

<http://emailbydomain.com>

Auto manuals search

<http://auto.somanuals.com>

TV manuals search

<http://tv.somanuals.com>