

DENON

AV SURROUND RECEIVER

AVR-987

OPERATING INSTRUCTIONS

SAFETY PRECAUTIONS



CAUTION:
TO REDUCE THE RISK OF ELECTRIC SHOCK, DO NOT REMOVE COVER (OR BACK). NO USER-SERVICEABLE PARTS INSIDE. REFER SERVICING TO QUALIFIED SERVICE PERSONNEL.

 The lightning flash with arrowhead symbol, within an equilateral triangle, is intended to alert the user to the presence of uninsulated "dangerous voltage" within the product's enclosure that may be of sufficient magnitude to constitute a risk of electric shock to persons.

 The exclamation point within an equilateral triangle is intended to alert the user to the presence of important operating and maintenance (servicing) instructions in the literature accompanying the appliance.

WARNING:
TO REDUCE THE RISK OF FIRE OR ELECTRIC SHOCK, DO NOT EXPOSE THIS APPLIANCE TO RAIN OR MOISTURE.

SAFETY INSTRUCTIONS

1. Read Instructions – All the safety and operating instructions should be read before the product is operated.
2. Retain Instructions – The safety and operating instructions should be retained for future reference.
3. Heed Warnings – All warnings on the product and in the operating instructions should be adhered to.
4. Follow Instructions – All operating and use instructions should be followed.
5. Cleaning – Unplug this product from the wall outlet before cleaning. Do not use liquid cleaners or aerosol cleaners.
6. Attachments – Do not use attachments not recommended by the product manufacturer as they may cause hazards.
7. Water and Moisture – Do not use this product near water – for example, near a bath tub, wash bowl, kitchen sink, or laundry tub; in a wet basement; or near a swimming pool; and the like.
8. Accessories – Do not place this product on an unstable cart, stand, tripod, bracket, or table. The product may fall, causing serious injury to a child or adult, and serious damage to the product. Use only with a cart, stand, tripod, bracket, or table recommended by the manufacturer, or sold with the product. Any mounting of the product should follow the manufacturer's instructions, and should use a mounting accessory recommended by the manufacturer.
9. A product and cart combination should be moved with care. Quick stops, excessive force, and uneven surfaces may cause the product and cart combination to overturn.
10. Ventilation – Slots and openings in the cabinet are provided for ventilation and to ensure reliable operation of the product and to protect it from overheating, and these openings must not be blocked or covered. The openings should never be blocked by placing the product on a bed, sofa, rug, or other similar surface. This product should not be placed in a built-in installation such as a bookcase or rack unless proper ventilation is provided or the manufacturer's instructions have been adhered to.
11. Power Sources – This product should be operated only from the type of power source indicated on the marking label. If you are not sure of the type of power supply to your home, consult your product dealer or local power company. For products intended to operate from battery power, or other sources, refer to the operating instructions.
12. Grounding or Polarization – This product may be equipped with a polarized alternating-current line plug (a plug having one blade wider than the other). This plug will fit into the power outlet only one way. This is a safety feature. If you are unable to insert the plug fully into the outlet, try reversing the plug. If the plug should still fail to fit, contact your electrician to replace your obsolete outlet. Do not defeat the safety purpose of the polarized plug.
13. Power-Cord Protection – Power-supply cords should be routed so that they are not likely to be walked on or pinched by items placed upon or against them, paying particular attention to cords at plugs, convenience receptacles, and the point where they exit from the product.
15. Outdoor Antenna Grounding – If an outside antenna or cable system is connected to the product, be sure the antenna or cable system is grounded so as to provide some protection against voltage surges and built-up static charges. Article 810 of the National Electrical Code, ANSI/NFPA 70, provides information with regard to proper grounding of the mast and supporting structure, grounding of the lead-in wire to an antenna discharge unit, size of grounding conductors, location of antenna-discharge unit, connection to grounding electrodes, and requirements for the grounding electrode. See Figure A.
16. Lightning – For added protection for this product during a lightning storm, or when it is left unattended and unused for long periods of time, unplug it from the wall outlet and disconnect the antenna or cable system. This will prevent damage to the product due to lightning and power-line surges.
17. Power Lines – An outside antenna system should not be located in the vicinity of overhead power lines or other electric light or power circuits, or where it can fall into such power lines or circuits. When installing an outside antenna system, extreme care should be taken to keep from touching such power lines or circuits as contact with them might be fatal.
18. Overloading – Do not overload wall outlets, extension cords, or integral convenience receptacles as this can result in a risk of fire or electric shock.
19. Object and Liquid Entry – Never push objects of any kind into this product through openings as they may touch dangerous voltage points or short-out parts that could result in a fire or electric shock. Never spill liquid of any kind on the product.
20. Servicing – Do not attempt to service this product yourself as opening or removing covers may expose you to dangerous voltage or other hazards. Refer all servicing to qualified service personnel.
21. Damage Requiring Service – Unplug this product from the wall outlet and refer servicing to qualified service personnel under the following conditions:
 - a) When the power-supply cord or plug is damaged,
 - b) If liquid has been spilled, or objects have fallen into the product,
 - c) If the product has been exposed to rain or water,
 - d) If the product does not operate normally by following the operating instructions. Adjust only those controls that are covered by the operating instructions as an improper adjustment of other controls may result in damage and will often require extensive work by a qualified technician to restore the product to its normal operation,
 - e) If the product has been dropped or damaged in any way, and
 - f) When the product exhibits a distinct change in performance – this indicates a need for service.
22. Replacement Parts – When replacement parts are required, be sure the service technician has used replacement parts specified by the manufacturer or have the same characteristics as the original part. Unauthorized substitutions may result in fire, electric shock, or other hazards.
23. Safety Check – Upon completion of any service or repairs to this product, ask the service technician to perform safety checks to determine that the product is in proper operating condition.
24. Wall or Ceiling Mounting – The product should be mounted to a wall or ceiling only as recommended by the manufacturer.
25. Heat – The product should be situated away from heat sources such as radiators, heat registers, stoves, or other products (including amplifiers) that produce heat.

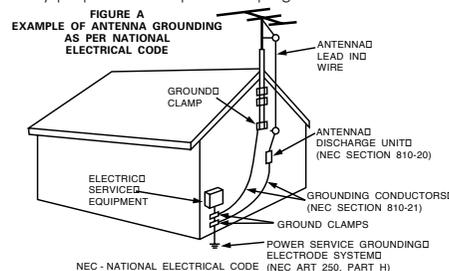

FCC INFORMATION (For US customers)

1. PRODUCT

This product complies with Part 15 of the FCC Rules. Operation is subject to the following two conditions: (1) this product may not cause harmful interference, and (2) this product must accept any interference received, including interference that may cause undesired operation.

2. IMPORTANT NOTICE: DO NOT MODIFY THIS PRODUCT

This product, when installed as indicated in the instructions contained in this manual, meets FCC requirements. Modification not expressly approved by DENON may void your authority, granted by the FCC, to use the product.

3. NOTE

This product has been tested and found to comply with the limits for a Class B digital device, pursuant to Part 15 of the FCC Rules. These limits are designed to provide reasonable protection against harmful interference in a residential installation.

This product generates, uses and can radiate radio frequency energy and, if not installed and used in accordance with the instructions, may cause harmful interference to radio communications. However, there is no guarantee that interference will not occur in a particular installation. If this product does cause harmful interference to radio or television reception, which can be determined by turning the product OFF and ON, the user is encouraged to try to correct the interference by one or more of the following measures:

- Reorient or relocate the receiving antenna.
- Increase the separation between the equipment and receiver.
- Connect the product into an outlet on a circuit different from that to which the receiver is connected.
- Consult the local retailer authorized to distribute this type of product or an experienced radio/TV technician for help.

This Class B apparatus complies with Canadian ICES-003.

Cet appareil numérique de la classe B est conforme à la norme NMB-003 du Canada.

NOTE ON USE / OBSERVATIONS RELATIVES A L'UTILISATION

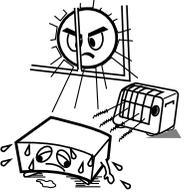
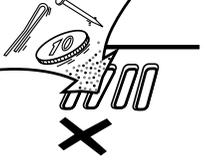
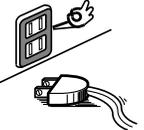
 <ul style="list-style-type: none"> • Avoid high temperatures. Allow for sufficient heat dispersion when installed in a rack. • Eviter des températures élevées. Tenir compte d'une dispersion de chaleur suffisante lors de l'installation sur une étagère. 	 <ul style="list-style-type: none"> • Keep the apparatus free from moisture, water, and dust. • Protéger l'appareil contre l'humidité, l'eau et la poussière. 	 <ul style="list-style-type: none"> • Do not let foreign objects into the apparatus. • Ne pas laisser des objets étrangers dans l'appareil.
 <ul style="list-style-type: none"> • Handle the power cord carefully. Hold the plug when unplugging the cord. • Manipuler le cordon d'alimentation avec précaution. Tenir la prise lors du débranchement du cordon. 	 <ul style="list-style-type: none"> • Unplug the power cord when not using the apparatus for long periods of time. • Débrancher le cordon d'alimentation lorsque l'appareil n'est pas utilisé pendant de longues périodes. 	 <ul style="list-style-type: none"> • Do not let insecticides, benzene, and thinner come in contact with the apparatus. • Ne pas mettre en contact des insecticides, du benzène et un diluant avec l'appareil.
 <ul style="list-style-type: none"> • Handle the power cord carefully. Hold the plug when unplugging the cord. • Manipuler le cordon d'alimentation avec précaution. Tenir la prise lors du débranchement du cordon. 	 <p>* (For apparatuses with ventilation holes)</p> <ul style="list-style-type: none"> • Do not obstruct the ventilation holes. • Ne pas obstruer les trous d'aération. 	 <ul style="list-style-type: none"> • Never disassemble or modify the apparatus in any way. • Ne jamais démonter ou modifier l'appareil d'une manière ou d'une autre.

- **We greatly appreciate your purchase of the AVR-987.**
- **To be sure you take maximum advantage of all the features the AVR-987 has to offer, read these instructions carefully and use the set properly. Be sure to keep this manual for future reference should any questions or problems arise.**

“SERIAL NO. _____

**PLEASE RECORD UNIT SERIAL NUMBER ATTACHED TO THE REAR OF THE CABINET FOR
FUTURE REFERENCE”**

MEMO _____

Getting Started

Thank you for choosing the DENON AVR-987 AV Surround Receiver. This remarkable component has been engineered to provide superb surround sound listening with home theater sources such as DVD, as well as providing outstanding high fidelity reproduction of your favorite music sources.

As this product is provided with an immense array of features, we recommend that before you begin hookup and operation that you review the contents of this manual before proceeding.

Contents

Getting Started

Accessories	3
Before using	3
Cautions on installation	3
About the remote control unit	3
Inserting the batteries	3
Operating range of the remote control unit	3
Part names and functions	
Front panel	4
Display	4
Rear panel	5
Remote control unit	5, 6

Easy Setup Procedure

Easy to setup flow	6
Speaker layout [Basic layout]	6
Speaker connections	7
Connecting a DVD player and monitor	8
Auto Setup/Room Equalizer (Room EQ) Functions	9
① Connecting a microphone	9
② Before performing the Auto Setup procedure	10
③ Perform the Auto Setup procedure	10
④ Assigning power amplifiers	10
⑤ Switching the front speaker	10
⑥ Preliminary measurements	11
⑦ Speaker measurements	11
⑧ Checking and storing the measurement results	12
Error messages	12

Connecting Other Sources

Cable indications	13
The video conversion function	14
Relationship between the video input signal and monitor output according to the video convert settings	14, 15

The analog video to HDMI conversion function	15
Connecting equipment with HDMI terminals [To convert analog video signals to HDMI signals]	16
Connecting a TV tuner	16
Connecting a DBS tuner	16
Connecting the external inputs (EXT. IN) terminals	17
Connecting a video camera or video game	17
Connecting a CD player	17
Connecting a turntable	17
Connecting a DVD recorder	18
Connecting a VCR	18
Connecting a tape deck	18
Connecting a CD recorder or MD recorder	19
Connecting equipment with HDMI terminals	19
Connecting the antenna terminals	20
Connecting the XM terminal	20
Connecting the iPod	21
Connecting the RS-232C terminal	21
Connecting the TRIGGER OUT jacks	21
Connecting the MULTI ZONE terminals	
ZONE2 out connections	21
ZONE2 speaker out connections	22
Connecting the PRE OUT terminals	22
Connecting the power supply cord	22

Basic Operation

Playing the input source	23
Selecting the room equalizer mode	24
Turning the sound off temporarily (MUTING)	24
Listening over headphones	24
Switching the front speakers	24
Checking the currently playing program source, etc.	24
Switching the brightness of the display	24

Using the surround modes

Types of surround modes and their features	25
Selecting the play mode (PURE DIRECT / DIRECT / STEREO)	25
Selecting the Dolby Digital and DTS Surround mode (only with digital input)	26, 27
Selecting the Dolby Pro Logic IIx (Pro Logic II) mode	27
Selecting the DTS NEO:6 mode	28
Checking the input signals	28
Surround modes and parameters	29 ~ 31

Using the DENON original surround modes

Types of surround modes and their features	32
Selecting the DSP surround simulation	33
Setting the tone control	34
Adjusting the speaker volume	34
Using the fader function	35

Listening to the radio

Auto tuning	35
Manual tuning	35
Preset memory	35
Checking the preset stations	36
Recalling preset stations	36
XM Satellite Radio	36
Checking the XM signal strength and Radio ID	37
Channel selection	37
Category search	37

Advanced Operation

Night mode	38
User mode function	38
Combining the currently playing sound with the desired image (VIDEO SELECT function)	38
Personal memory plus function	38
Playing the iPod	39
Listening to music	39
Viewing still pictures and videos (only for iPods equipped with the slideshow / video function)	39
Disconnecting the iPod	39
Multi zone music entertainment system	
Multi-zone playback using the ZONE2 output terminals	40
Multi-zone playback using the SPEAKER terminals	40
Outputting a program source to amplifier, etc., in the ZONE2 room (ZONE2 SELECT mode)	41
Remote control unit operations during multi-source playback	41
Recording (audio and/or video)	42
About the memory functions	42
Initialization of the microprocessor	42

Advanced Setup – Part 1	
System setup items and default values	43 ~ 45
Navigating through the System Setup Menu	46
About the display	46
Audio Input Setup	
Setting the Digital In Assignment	47
Setting the EXT. IN Subwoofer Level	47
Setting the iPod Assignment	47
Setting the Input Function Level	48
Setting the Function Rename	48
Setting the Tuner Presets	48, 49
Video Setup	
Setting the HDMI In Assignment	49, 50
Setting the Component In Assignment	50
Setting the Video Convert	50
Setting the HDMI Out Setup	51
Setting the Audio Delay	51
Setting the On Screen Display (OSD)	52
Advanced Playback	
Setting the 2ch Direct/Stereo	52
Setting the Dolby Digital Downmix Option Setup	53
Setting the Auto Surround Mode	53
Setting the Manual Equalizer Setup	53, 54
Option Setup	
Setting the Power Amplifier Assignment	54
Setting the Volume Control	55
Setting the Trigger Out	55
Setting the Setup Lock	56

Advanced Setup – Part 2	
Speaker Setup	
Setting the Speaker Configuration	56, 57
Setting the Subwoofer Setup	57
Setting the Distance	57, 58
Setting the Channel Level	58, 59
Setting the Crossover Frequency	59
Others Setup	
Setting the Room Equalizer Setup	60
Setting the Direct Mode Setup	60
Setting the MIC Input Select	61
Check the parameter	61

Operating the remote control unit	
Operating DENON audio components	62
Setting the preset memory function	62
Operating a component stored in the preset memory	63, 64
Setting the punch through function	65
Additional Information	
66 ~ 68	
Troubleshooting	
69, 70	
Specifications	
70	

List of preset codesEnd of this manual

Accessories

Check that the following parts are attached in addition to the main unit:

- | | |
|---|---|
| ① Operating instructions | 1 |
| ② Warranty (for North America model only) | 1 |
| ③ Service station list..... | 1 |
| ④ Power supply cord (Approx. 7-31/64 ft / 1.9 m)..... | 1 |
| ⑤ Remote control unit (RC-1051) | 1 |
| ⑥ R6P/AA batteries | 2 |
| ⑦ AM loop antenna | 1 |
| ⑧ FM indoor antenna..... | 1 |
| ⑨ Setup microphone (DM-S205) (Approx. 23-5/8 ft / 6 m)... | 1 |

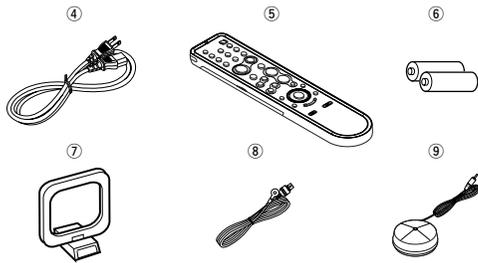

Before using

Pay attention to the following before using this unit:

- **Moving the unit**

To prevent short-circuits or damaged wires in the connection cables, always unplug the power supply cord and disconnect the connection cables between all other audio components when moving the unit.

- **Before turning the power switch on**

Check once again that all connections are correct and that there are not problems with the connection cables. Always set the power switch to the standby position before connecting and disconnecting connection cables.

- **Store these instructions in a safe place.**

After reading, store this instructions along with the warranty card in a safe place.

- **Whenever the power switch is in the STANDBY state, the unit is still connected to AC line voltage.**

Please be sure to turn off the power switch or unplug the cord when you leave home for, say, a vacation.

- **Note that the illustrations in these instructions may differ from the actual unit for explanation purposes.**

Cautions on installation

Note:

For heat dispersal, do not install this unit in a confined space such as a bookcase or similar enclosure.

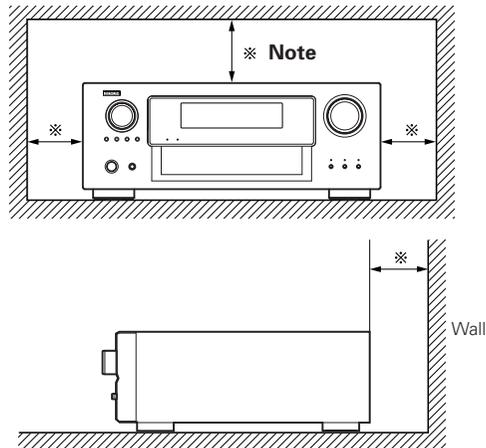

About the remote control unit

In addition to controlling the AVR-987, the attached remote control unit (RC-1051) can also be used to control the following products:

- ① DENON component products
- ② Component products other than DENON:
 - Set using the preset memory function (page 62, 63).

Inserting the batteries

- ① Remove the remote control unit's rear cover.
- ② Set 2 R6P/AA batteries in the battery compartment in the indicated direction.

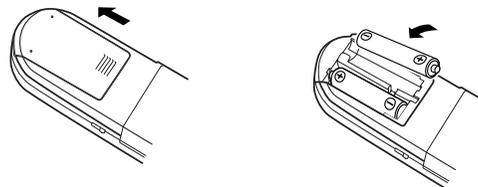

- ③ Put the rear cover back on.

Notes on batteries:

- Replace the batteries with new ones if the set does not operate even when the remote control unit is operated nearby the unit. (The attached batteries are only for verifying operation.)
- When inserting the batteries, be sure to do so in the proper direction, following the “+” and “-” marks in the battery compartment.
- To prevent damage or leakage of battery fluid:
 - Do not use a new battery together with an old one.
 - Do not use two different types of batteries.
 - Do not short-circuit, disassemble, heat or dispose of batteries in flames.
- Remove the batteries from the remote control unit when you do not plan to use it for an extended period of time.
- If the battery fluid should leak, carefully wipe the fluid off the inside of the battery compartment and insert new batteries.
- When replacing the batteries, have the new batteries ready and insert them as quickly as possible.

Operating range of the remote control unit

- Point the remote control unit at the remote sensor when operating it.
- The remote control unit can be used from a distance of approximately 23 feet/7 meters, at a horizontal angle of up to 30° with respect to the sensor.

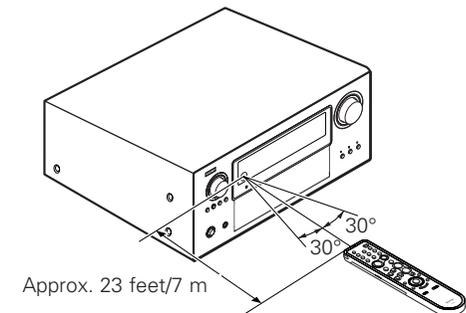
**NOTE:**

- It may be difficult to operate the remote control unit if the remote sensor is exposed to direct sunlight or strong artificial light.

Part names and functions

For details on the functions of these parts, refer to the pages given in parentheses ().

Front panel

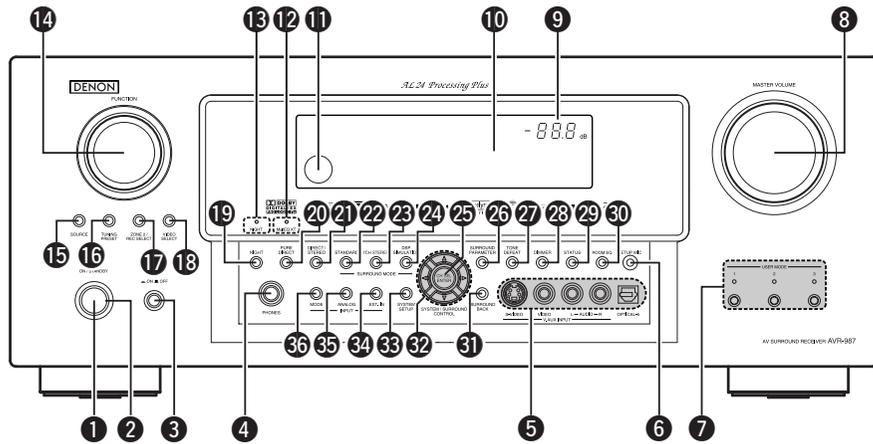

- 1 Power ON/STANDBY button.....(10)
- 2 Power indicator.....(10)
- 3 Power switch.....(10)
- 4 Headphones jack (PHONES)(25)
- 5 V.AUX INPUT terminals(17)
- 6 SETUP MIC jack(9)
- 7 USER MODE buttons.....(38)
- 8 MASTER VOLUME control knob.....(23)
- 9 Master volume indicator
- 10 Display
- 11 MultEQ XT indicator.....(24)
- 12 NIGHT indicator(38)
- 13 Remote control sensor.....(3)
- 14 FUNCTION knob.....(23)
- 15 SOURCE button(23)
- 16 TUNING PRESET button(36)
- 17 ZONE2/REC SELECT button(41, 42)
- 18 VIDEO SELECT button.....(38)
- 19 NIGHT button.....(38)
- 20 PURE DIRECT button.....(25)
- 21 DIRECT/STEREO button.....(25)
- 22 STANDARD button(26)
- 23 7CH STEREO button.....(33)
- 24 DSP SIMULATION button.....(33)
- 25 CH SELECT/ENTER button.....(10, 34)
- 26 SURROUND PARAMETER button(26)
- 27 TONE DEFEAT button.....(34)
- 28 DIMMER button(24)
- 29 STATUS button(24)
- 30 ROOM EQ button.....(24)
- 31 SURROUND BACK button(26)
- 32 Cursor (Δ, ▽, ◀, ▶) buttons.....(10)
- 33 SYSTEM SETUP button(10)
- 34 EXT. IN button.....(23)
- 35 ANALOG button.....(23)
- 36 INPUT MODE button(23)

Display

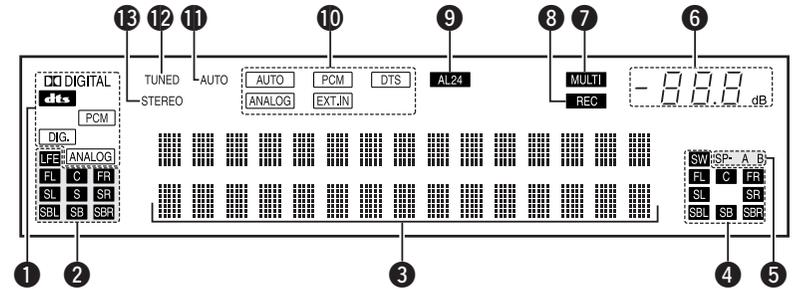

- 1 Input signal indicator
- 2 Input signal channel indicator
 - The audio channel(s) included in the input signal light(s).
 - This lights when the digital signal is inputted.
- 3 Information display
- 4 Output signal channel indicator
 - The audio channels that can be output light.
- 5 Speaker indicator
 - This lights corresponding to the settings of the surround speakers of the various surround modes.
- 6 Master volume indicator
 - This displays the volume level.
 - The Setup item number is displayed in System Setup.
- 7 MULTI (zone) indicator
 - ZONE2 mode is selected in ZONE2/REC SELECT.
- 8 REC indicator
 - REC OUT mode is selected in ZONE2/REC SELECT.
- 9 AL24 indicator
 - This lights when the following mode is selected while inputting digital (PCM) signals.
 - PURE DIRECT / DIRECT / STEREO / MULTI CH PURE DIRECT / MULTI CH DIRECT / MULTI CH IN
- 10 Input mode indicator
- 11 AUTO indicator
 - This lights when the broadcast station is selected in the AUTO tuning mode.
- 12 TUNED indicator
 - This lights when an FM/AM broadcast has been received.
- 13 STEREO indicator
 - This lights when an FM stereo broadcast has been received.

Rear panel

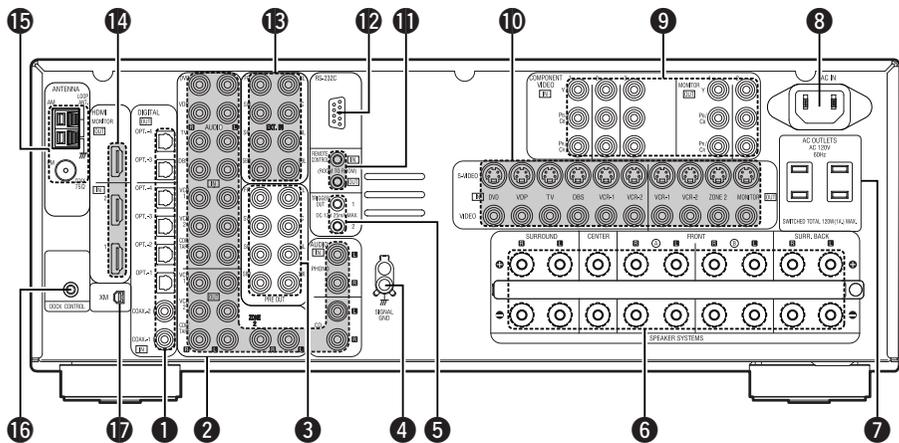

- 1 DIGITAL terminals** (Optical/Coaxial)(8)
- 2 AUDIO terminals**(8)
- 3 PRE OUT terminals**(22)
- 4 SIGNAL GND terminal**(17)
- 5 TRIGGER OUT jacks**(21)
- 6 Speaker terminals**(7)
- 7 AC outlets**(22)
- 8 AC inlet**(22)
- 9 COMPONENT VIDEO terminals**(8)
- 10 VIDEO/S-VIDEO terminals**(8)
- 11 REMOTE CONTROL jacks**(21)
- 12 RS-232C terminal**(21)
- 13 EXT. IN terminals**(17)
- 14 HDMI MONITOR terminals**(19)
- 15 ANTENNA terminals**(20)
- 16 DOCK CONTROL jack**(21)
- 17 XM terminal**(20)

Remote control unit

To operate the AVR-987, use the mode selector switches to select "TAPE" "CD-R/MD" or "CD", mode.

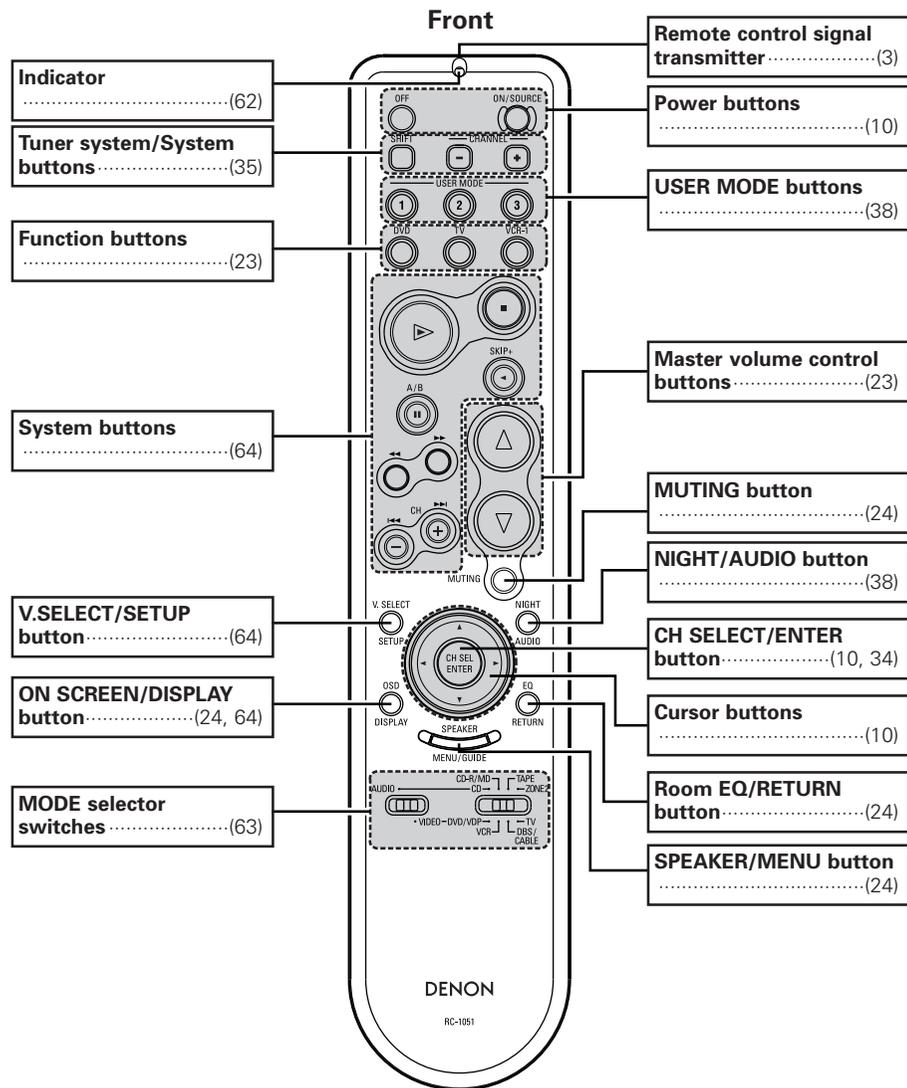

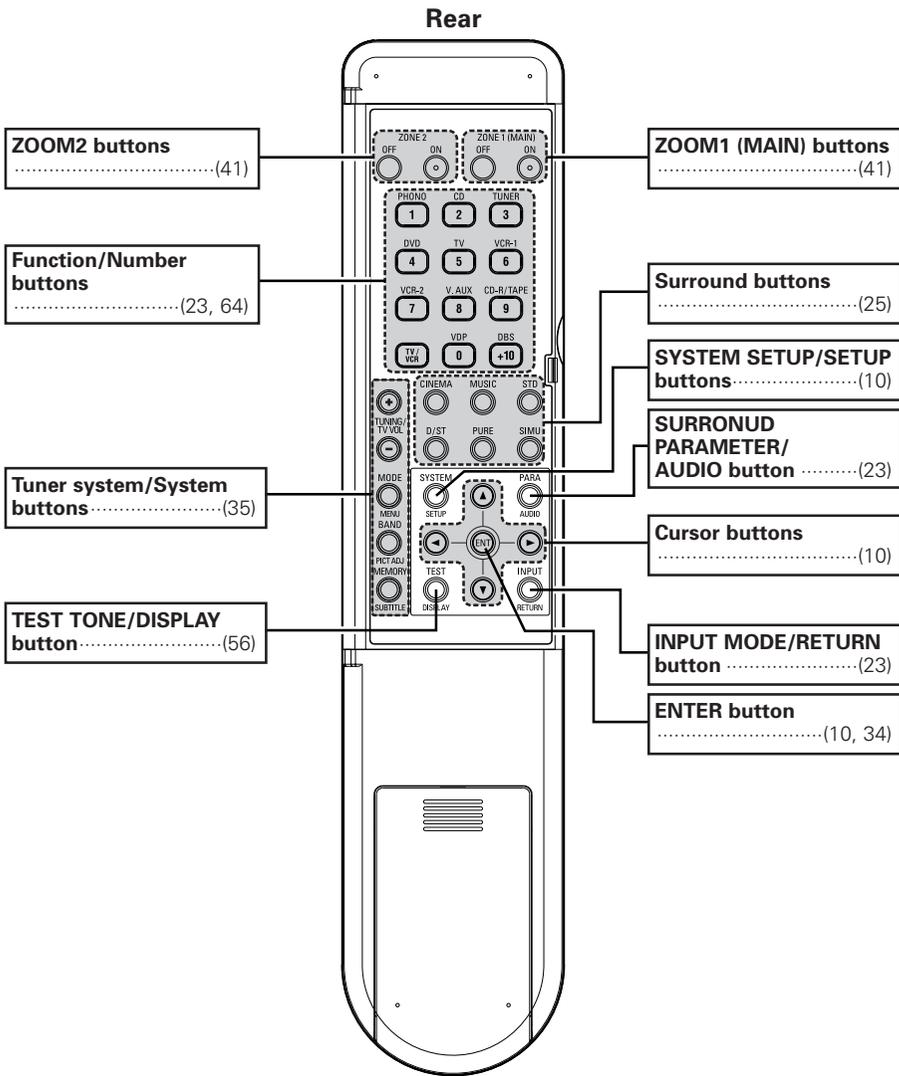

Easy Setup Procedure

- This section contains the basic steps necessary to configure the AVR-987 according to your listening room environment and the source equipment and loudspeakers you are using.
- To set the sound field manually, see pages 56 ~59.

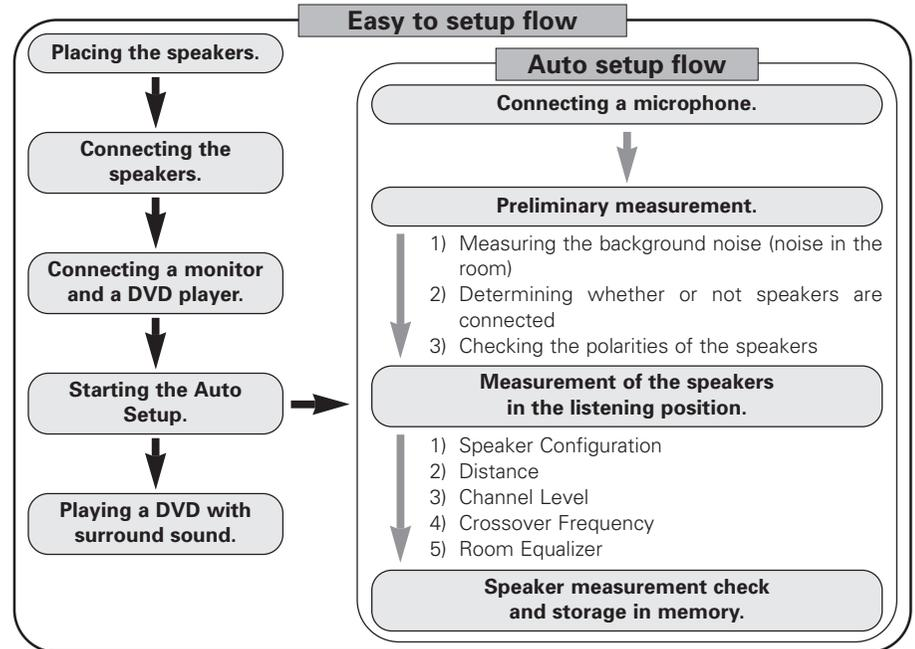

Speaker layout [Basic layout]

Example of basic layout with 8 speakers and a monitor.

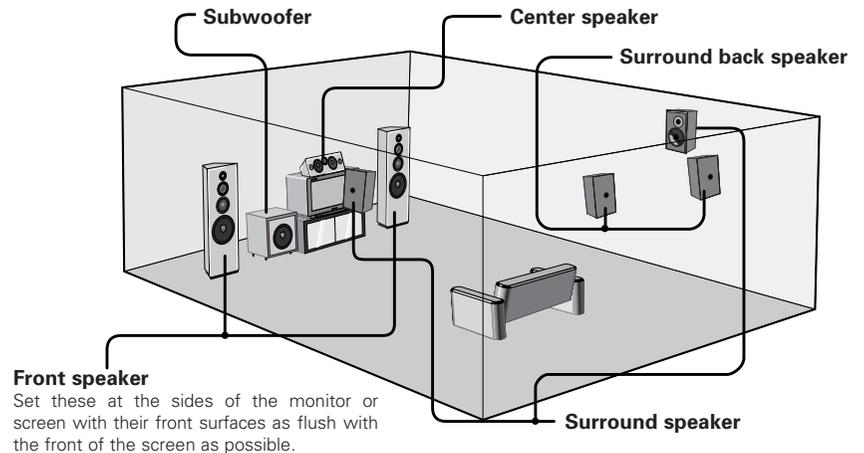

NOTE:

- If buttons on the front or rear are pressed strongly, the button on the opposite side will be activated too.

Speaker connections

Connect the speaker terminals with the speakers making sure that like polarities are matched (⊕ with ⊕, ⊖ with ⊖).

NOTE:
When making connections, take care that none of the individual conductors of the speaker cable come in contact with adjacent terminals, with other speaker cable conductors, or with the rear panel and screws.
NEVER touch the speaker terminals when the power is on. Doing so could result in electric shocks.

Connecting the speaker cables

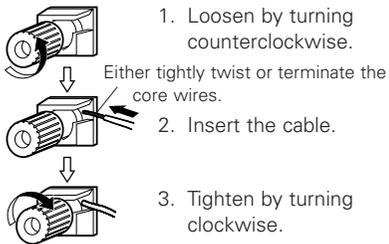

Connecting banana plugs

Turn clockwise to tighten, then insert the banana plug.

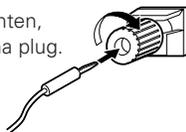

Speaker impedance

Speaker	Impedance
Front A, B	6 ~ 16 Ω/ohms
Front A+B	8 ~ 16 Ω/ohms
Center	6 ~ 16 Ω/ohms
Surround	
Surround back	

Note on speaker impedance

When using speakers with an impedance below the designated value (for example 4 Ω/ohms), playing for long periods of time with the volume high could cause the temperature to rise, activating the protection circuit.

When the protection circuit is activated, the output to the speakers is cut off and the power indicator blinks. If this happens, unplug the power cord, wait for the set to cool off and improve ventilation around the unit. Also check the wiring of the input cables and the speaker cables. After doing this, plug the power cord back in and turn the unit's power back on.

If the protection circuit is activated again even though there are no problems with the wiring or the ventilation around the unit, switch off the power and contact a DENON service center.

Connections

- With the AVR-987, up to 10 speakers can be connected for surround playback.
- When making connections, also refer to the operating instructions of the other components.

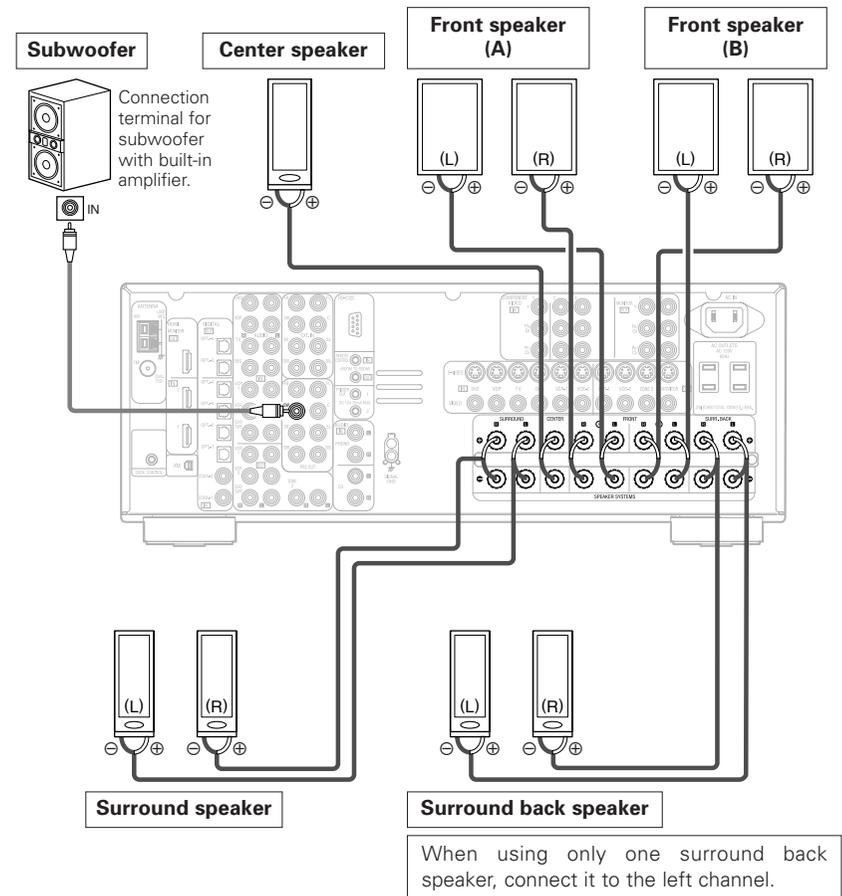

Easy Setup Procedure

Connecting a DVD player and monitor

- To connect the video output from the DVD player to the AVR-987, you only need to choose one connection type. For more information about the video up conversion function (👉 page 14, 15).
- To connect the digital audio output from the DVD player, you can choose from either the coaxial or optical connections. If you choose to use the optical connection, it needs to be assigned. For more information about Digital Input Assignment (👉 page 47).

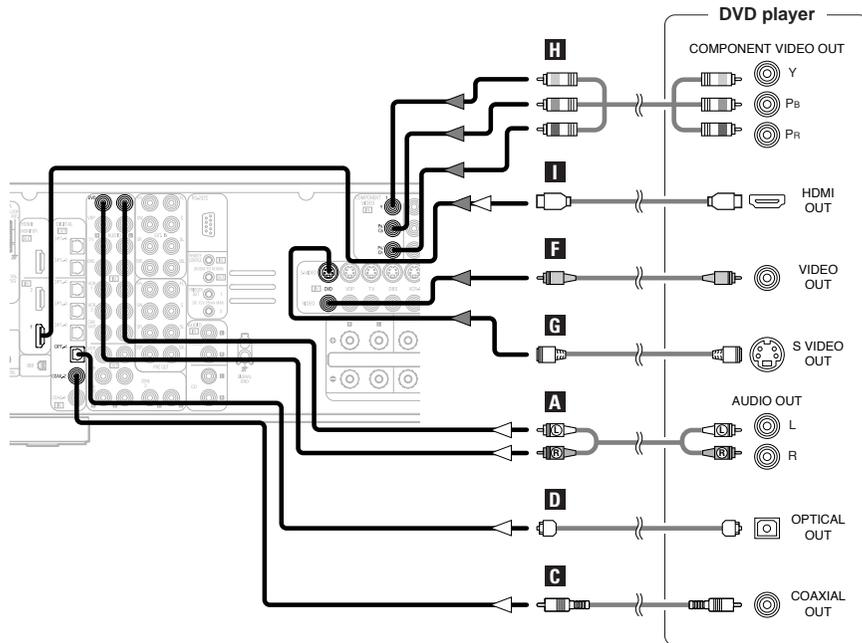

※ Audio signal flow is shown with white arrows, video signal flow is shown with gray arrows.



- The AVR-987 is equipped with another set of input terminals for a non-DVD video disc player (such as laser disc, VCD/SVCD, or future high definition disc player). The above connection guidelines for DVD also apply to the VDP input.

Easy Setup Procedure

- For best picture quality (especially with progressive DVD and other high definition sources), choose the component video or HDMI connection to your monitor. S-Video and composite video outputs are also provided if your monitor does not have component video inputs.

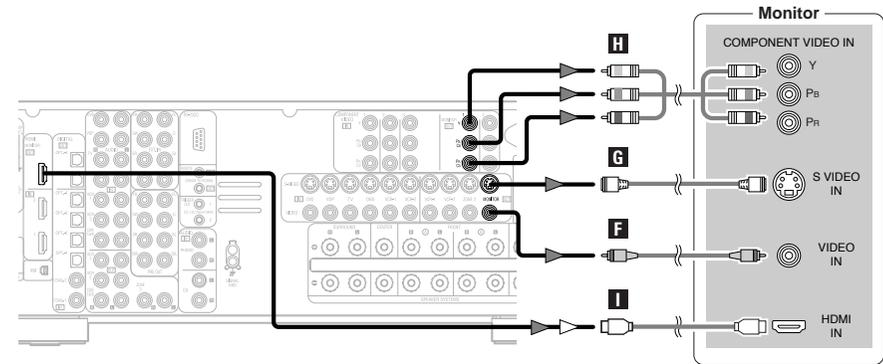

- The AVR-987 is equipped with HDMI terminals, so it can be connected to a DVD player or monitor using an HDMI cable.
- The component video input and/or output terminals may be labelled differently on some monitors or video components. Check the owner's manuals for other components for further information.
- The COMPONENT MONITOR OUT-1 and the COMPONENT MONITOR OUT-2 can be used simultaneously.
- Audio signals are only output from the HDMI monitor out terminal when audio signals are input to the HDMI input terminal.
- When connecting the AVR-987 and DVD player using an HDMI cable, also connect the AVR-987 and monitor using an HDMI cable (👉 page 19).

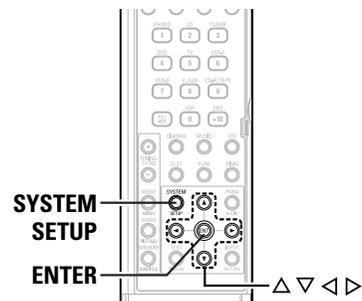
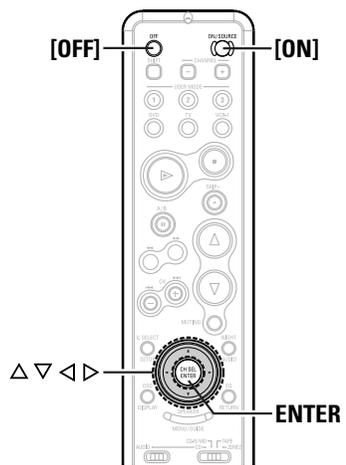
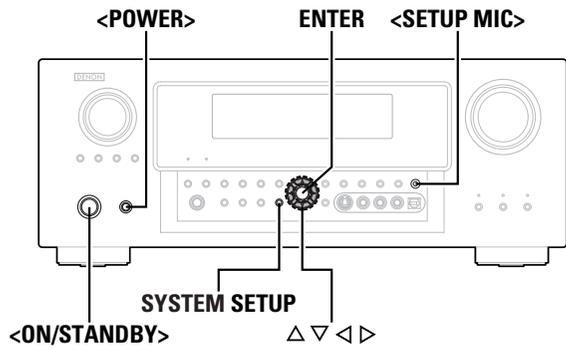

About the button names in this explanation
 < > : Buttons on the main unit
 [] : Buttons on the remote control unit
Button name only :
 Buttons on the main unit and remote control unit

Auto Setup/Room Equalizer (Room EQ) Functions

- The AVR-987's auto setup and room equalizer functions use the attached microphone to measure the acoustic properties in the room and automatically make the optimum settings.
- The optimum listening environment at all listening positions in the home theater is achieved so multiple listeners can enjoy listening at the same time.

As shown in Example ①, as you make the measurements, move the microphone successively to the different positions in which the members of the family sit within the listening area surrounded by the speakers. For best results, make the measurements at 6 locations.

Even if the home theater is only used by a small number of people, as in Example ②, more effective equalization can be achieved by taking the measurements in the area around the listening position.

- When the auto setup procedure is performed, one of the following 3 correction curves can be selected for the room equalizer function.

Audyssey:
 The frequency response of all the speakers is adjusted to achieve the optimum environment for the room's acoustics.

Front:
 This adjusts the characteristics of each speaker to the characteristics of the front speakers.

Flat:
 This the frequency response of all speakers flat. This mode is optimum for playing multi-channel signal music.



- To make the sound field settings manually, see pages 56 ~ 59.

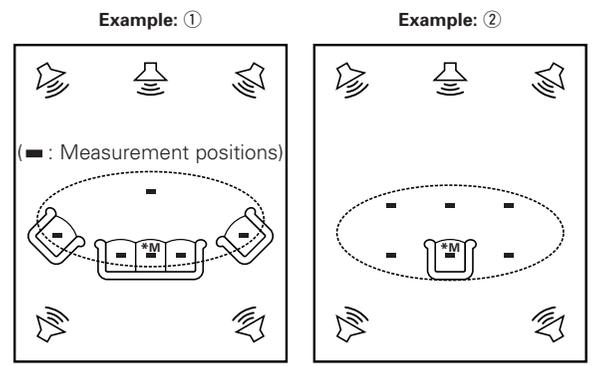

■ About the main listening position (*M)
 The "main listening position" refers to either the center of the listening position or the position in which the user sits when using the system alone. The distance to the speakers is measured from this position.

① Connecting a microphone

- 1 Connect the attached setup microphone to <SETUP MIC>.

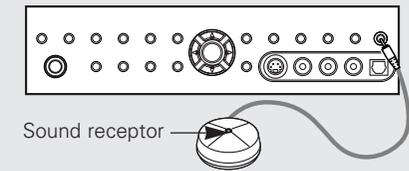

- 2 Mount the setup microphone on a camera tripod, etc., and set with the receptor pointing towards the ceiling.

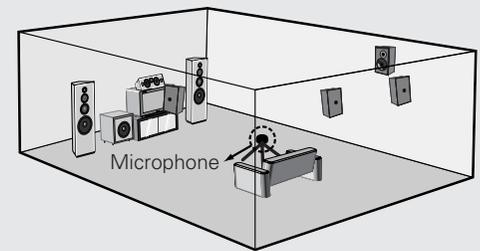

- ※ Place the setup microphone's sound receptor at the height of the ears in the listening position.
- ※ Be sure that at the beginning, the measurement is started with the microphone set up at the main listening position.
- ※ It is not possible to measure properly if there are any obstacles between the speakers and microphone. Check that there are no obstacles.

NOTE:
 • Once the settings are completed, disconnect the setup microphone.

Easy Setup Procedure

② Before performing the Auto Setup procedure

1 Turn on your subwoofer.

- ※ Set the volume to halfway and set the crossover frequency to the maximum or Low pass filter off if your subwoofer can adjust the output volume and the crossover frequency.
- ※ Some subwoofers have a standby mode. Be sure to turn this function off before performing the Auto Setup procedure.

2 Turn on your monitor.

3 Press <POWER>.

ON:

The power indicator lights red.

OFF:

The power turns off and the indicator is off.

4 Press <ON/STANDBY> or [ON].

- The power indicator blinks green and the power turns on.

③ Perform the Auto Setup procedure

1 Press SYSTEM SETUP.

2 Press Δ ∇ to select “Auto Setup / Room EQ”, then press ENTER.

3 Press Δ ∇ to select “Auto Setup”, then press ENTER.

- ※ The message “Connect Microphone” is displayed if no microphone is connected. If so, connect the auto setup microphone.

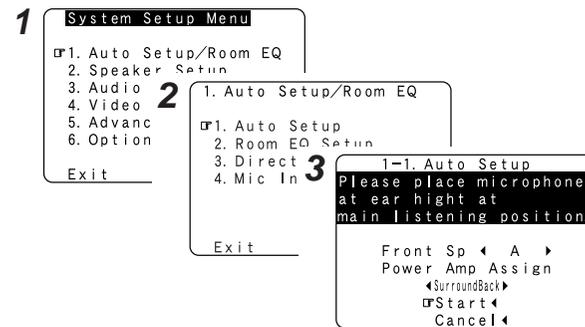

- “System Setup Menu” is not displayed when using headphones.

Easy Setup Procedure

④ Assigning power amplifiers

The surround back output can be assigned to the “Front” or “ZONE2” output.

Press Δ ∇ to select “Power Amp Assign”, then press \triangleleft \triangleright to set.

Surround Back:

Assign to use as surround back speaker.

Front A, Front B:

Assign to use the “Front A” (or “Front B”) speakers with bi-amp connections.

ZONE2:

Assign to use as “ZONE2” speakers.

- ※ When assigned to “Front”, skip the surround back channel measurement.

- ※ During the auto setup procedure, test tones are not output to “ZONE2”.



⑤ Switching the front speaker

Press Δ ∇ to select “Front Sp”, then press \triangleleft \triangleright to select the speaker.



⑥ Preliminary measurements

This procedure is used to automatically determine the background noise, whether or not speakers are connected, and the polarities of the connected speakers.

1 Press $\Delta \nabla$ to select “Start”, then press \triangleleft .
 • The preliminary measurements start.

2 Press $\Delta \nabla$ to select “Speaker Detect Check”, then press ENTER.

3 Press ENTER again.

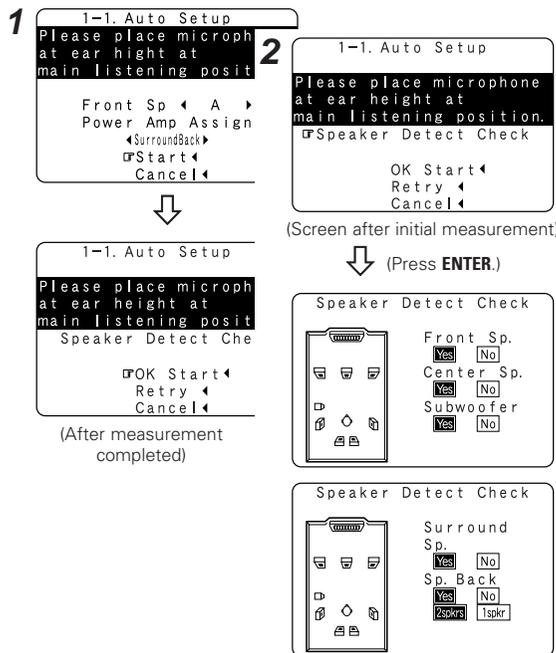

Cautions during measurements:

- Loud test tones are output during the measurements. Be careful for example when small children are nearby.
- Proper measurements may not be possible if there are obstacles between the speaker and the setup microphone.
- During the measurements, do not stand between or near the speakers and setup microphone.
- To avoid influencing the measurements, turn off the power of air-conditioners or any other equipment producing sound in the room. Perform the measurements with the room as quiet as possible.
- Measurement is cancelled when **VOLUME** is operated while the Auto Setup is performed.

⑦ Speaker measurements

With these measurements, the “Speaker Configuration”, “Distance”, “Channel Level”, “Crossover Frequency” and “Room EQ” settings are analyzed automatically. The main listening position is measured first, so leave the microphone where it is.

1 Press $\Delta \nabla$ to select “OK Start”, then press \triangleleft .
 • Measurements for the first point start.

2 Move the microphone to the second point and press \triangleleft .
 • Measurements for the second point start.

※ Once the measurements are finished, the results of the measurements for the second point are displayed.

3 Perform step 2 repeatedly.

※ Measurements can be ended when there are 6 or less measurement locations; however, to obtain better results, measurements at **6 locations** is recommended.

4 Press $\Delta \nabla$ to select “Calculate”, then press \triangleleft .
 • The speaker is analyzed.

- ※ Once the calculations are completed, a screen for confirming the results of the measurements appears.
- ※ The amount of time required for the analysis depends on the number of speakers and the number of measuring points. The greater the number of speakers and measuring points, the longer the time required.

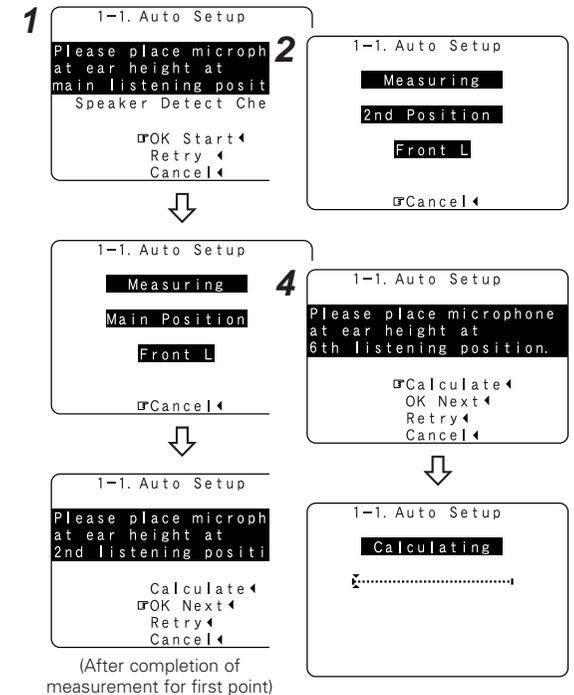

NOTE:

- Do not change the speaker connections or subwoofer volume after making the measurements.

⑧ Checking and storing the measurement results

The measurement results displayed at “⑦ Speaker measurements” can be checked and stored in the memory.

1 Press Δ ∇ to select the item, then press ENTER.

※ Press **ENTER** to switch to the second screen.

2 After checking, press ENTER, then press Δ ∇ to set.

Store:

All the settings are stored in the memory.

Cancel:

Cancel the auto setup settings.

3 When “Store” is selected:

Press \triangleleft .

- After the data is stored, the “Auto Setup / Room EQ” screen appears automatically.

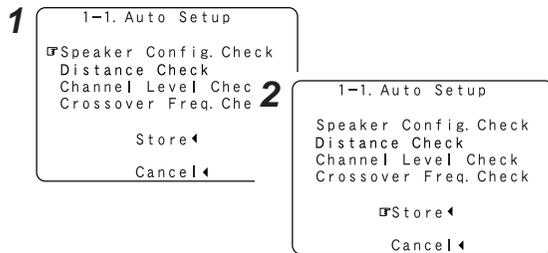

- When measurements have been made using the measurement microphone, speakers with a built-in filter such as subwoofers might be set with a value that differs from the physical distance because of the internal electrical delay.

NOTE:

- Do not turn off the power while the data is being stored.

Error messages

An error message is displayed if the measurements could not be completed automatically due to the speaker layout, the measuring environment, etc. Please check the following matters, reset the pertinent items, and measure again. Be sure to turn off the AVR-987's power before checking the speaker connections.

Example	Cause	Measures
	<p>① The speakers required for producing suitable reproduction have not been detected.</p> <p>※ If multiple errors occur, press \triangleleft \triangleright to check the contents.</p>	<ul style="list-style-type: none"> • Check that the pertinent speakers are properly connected.
	<p>② The speaker polarity is connected in reverse.</p> <p>※ If multiple errors occur, press \triangleleft \triangleright to check the contents.</p>	<ul style="list-style-type: none"> • Check the polarity of the pertinent speakers. • For some speakers, the screen below may be displayed even though the speakers are properly connected. If so, select “Skip\triangleleft”.
	<p>③ There is too much ambient noise in the room and the measurements cannot be made accurately.</p> <p>④ The sound level that is output from the speakers and/or subwoofer is too low.</p>	<ul style="list-style-type: none"> • Either turn off the power of the device that generated the noise during the measurements or move the device away. • Try again at a time when it is quieter. • Check the placement and orientation of the loudspeakers. • Adjust the subwoofer's output level.
	<p>⑤ The measurement microphone is not connected, or all of speakers have not been detected.</p>	<ul style="list-style-type: none"> • Connect the attached setup microphone to <SETUP MIC>. • Check the speaker connection.

Connecting Other Sources

Cable indications

The hookup diagrams on the subsequent pages assume the use of the following optional connection cables (not supplied).

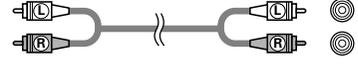
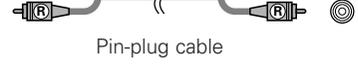
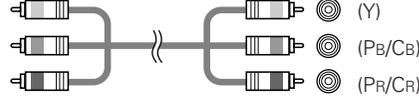
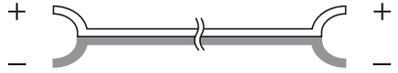
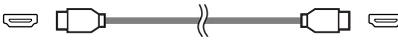
Audio cable	Video cable
<p>A Analog terminal (Stereo)</p> <p>(White)   </p> <p>(Red)   </p> <p style="text-align: center;">Pin-plug cable</p>	<p>F Video terminal</p> <p>(Yellow)   </p> <p style="text-align: center;">Video cable (75 Ω/ohms video pin-plug cable)</p>
<p>B Analog terminal (Monaural, for subwoofer)</p> <p></p> <p style="text-align: center;">Pin-plug cable</p>	<p>G S-Video terminal</p> <p></p> <p style="text-align: center;">S-Video cable</p>
<p>C Digital terminal (Coaxial)</p> <p>(Orange)   </p> <p style="text-align: center;">Coaxial cable (75 Ω/ohms pin-plug cable)</p>	<p>H Component video terminal</p> <p>(Green)    (Y)</p> <p>(Blue)    (P_B/C_B)</p> <p>(Red)    (P_R/C_R)</p> <p style="text-align: center;">Component video cable</p>
<p>D Digital terminal (Optical)</p> <p></p> <p style="text-align: center;">Optical cable (Optical fiber cable)</p>	<p>Audio and Video cable</p>
<p>E Speaker terminal</p> <p></p> <p style="text-align: center;">Speaker cable</p>	<p>I HDMI terminal</p> <p></p> <p style="text-align: center;">HDMI cable</p>
<p>Signal direction</p>	
<p>Audio signal </p> <p>Video signal </p>	

NOTE:

- Do not plug in the power supply cord until all connections have been completed.
- When making connections, also refer to the operating instructions of the other components.
- Be sure to connect the left and right channels properly (left with left, right with right).
- Do not bundle power cords together with speaker cables. Doing so could result in humming or noise.

The video conversion function

- Even if the formats of the video signals from the various players differ, the different formats can be converted and the signals output to the monitor from a single video output terminal. We recommend outputting with the format offering the highest quality video signals possible.
- With analog video signal connections, generally quality is higher in the order shown below.

The flow of the video signals.

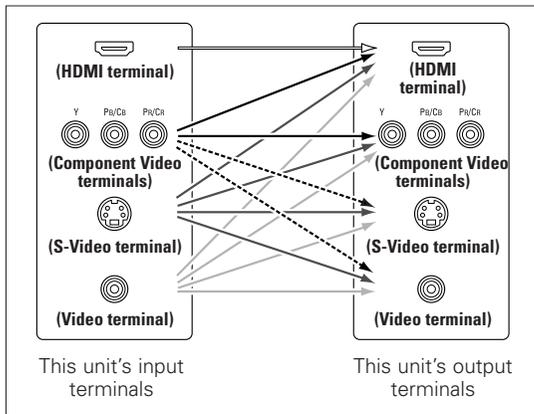

-----: only MAIN ZONE 480i/576i

Relationship between the video input signal and monitor output according to the video convert settings

Video convert	Input signals				MONITOR OUT			
	HDMI	COMPONENT	S-VIDEO	VIDEO	HDMI	COMPONENT	S-VIDEO	VIDEO
ON	X	X	X	X	X	X	X	X
	X	X	X	O	VIDEO	VIDEO	VIDEO	VIDEO
	X	X	O	X	S-VIDEO	S-VIDEO	S-VIDEO	S-VIDEO
	X	X	O	O	S-VIDEO	S-VIDEO	S-VIDEO	S-VIDEO
	X	O (1080p)	X	X	X	COMPONENT	X	X
	X	O (480p ~ 720p)	X	X	COMPONENT	COMPONENT	X	X
	X	O (480i/576i)	X	X	COMPONENT	COMPONENT	COMPONENT	COMPONENT
	X	O (1080p)	X	O	VIDEO	COMPONENT *1	VIDEO	VIDEO
	X	O (480p ~ 720p)	X	O	COMPONENT *1	COMPONENT *1	X *3	VIDEO
	X	O (480i/576i)	X	O	COMPONENT *1	COMPONENT *1	COMPONENT	VIDEO
	X	O (1080p)	O	X	S-VIDEO	COMPONENT *2	S-VIDEO	S-VIDEO
	X	O (480p ~ 720p)	O	X	COMPONENT *2	COMPONENT *2	S-VIDEO	S-VIDEO
	X	O (480i/576i)	O	X	COMPONENT *2	COMPONENT *2	S-VIDEO	S-VIDEO
	X	O (1080p)	O	O	S-VIDEO	COMPONENT *2	S-VIDEO	S-VIDEO
	X	O (480p ~ 720p)	O	O	COMPONENT *2	COMPONENT *2	S-VIDEO	S-VIDEO
	X	O (480i/576i)	O	O	COMPONENT *2	COMPONENT *2	S-VIDEO	S-VIDEO
	O	X	X	X	HDMI	X	X	X
	O	X	X	O	HDMI *1	VIDEO	VIDEO	VIDEO
	O	X	O	X	HDMI *2	S-VIDEO	S-VIDEO	S-VIDEO
	O	X	O	O	HDMI *2	S-VIDEO	S-VIDEO	S-VIDEO
	O	O (Other than 480i/576i)	X	X	HDMI	COMPONENT	X	X
	O	O (480i/576i)	X	X	HDMI	COMPONENT	COMPONENT	COMPONENT
	O	O (1080p)	X	O	HDMI *1	COMPONENT *1	VIDEO	VIDEO
	O	O (480p ~ 720p)	X	O	HDMI *1	COMPONENT *1	X *3	VIDEO
	O	O (480i/576i)	X	O	HDMI *1	COMPONENT *1	COMPONENT	VIDEO
	O	O (Other than 480i/576i)	O	X	HDMI *2	COMPONENT *2	S-VIDEO	S-VIDEO
	O	O (480i/576i)	O	X	HDMI *2	COMPONENT *2	S-VIDEO	S-VIDEO
	O	O (Other than 480i/576i)	O	O	HDMI *2	COMPONENT *2	S-VIDEO	S-VIDEO
	O	O (480i/576i)	O	O	HDMI *2	COMPONENT *2	S-VIDEO	S-VIDEO

O : Signal input
 X : No signal
 480p ~ 720p : 480p/576p/1080i/720p

X : Not output
 *1 : On screen display superimposed on video signal and output.
 *2 : On screen display superimposed on S-Video signal and output.
 *3 : Video signals are output when the "Analog to HDMI convert" is set to "OFF".
 COMPONENT : On screen display only displayed for **SYSTEM SETUP**, **SURROUND PARAMETER** and **ON SCREEN** buttons.
 HDMI : The on screen display is displayed when the "Analog to HDMI convert" is set to "ON".
 [Grey Box] : Video signals are not output when the "Analog to HDMI convert" is set to "OFF".



- The MAIN ZONE video conversion function is compatible with the following format: NTSC, PAL, SECAM, NTSC4.43, PAL-N, PAL-M and PAL-60.
- When SECAM signals of video input are up-converted, the signals are output in PAL format from the S-Video terminal.
- When the input signal is a component 480p, 576p, 1080i or 720p signal, the signal up-converted to HDMI is output with that resolution.
- When the input signal is a video, S-Video or component 480i or 576i signals, the signal up-converted to HDMI is output according to the setting made at "i/p Convert" under "HDMI Out Setup" (page 51).
- Signals up-converted to HDMI are output to the HDMI monitor with the resolution at which they are input. Note that resolutions of 1080p are not handled.

Video convert	S-VIDEO MONITOR OUT	Input signals				MONITOR OUT			
		HDMI	COMPONENT	S-VIDEO	VIDEO	HDMI	COMPONENT	S-VIDEO	VIDEO
OFF	–	×	×	×	×	×	×	×	×
	–	×	×	×	○	×	×	×	VIDEO
	–	×	×	○	×	×	×	S-VIDEO	×
	Used	×	×	○	○	×	×	S-VIDEO	VIDEO *2
	Not used	×	×	○	○	×	×	–	VIDEO
	–	×	○	×	×	×	COMPONENT	×	×
	–	×	○	×	○	×	COMPONENT *1	×	VIDEO
	–	×	○	○	×	×	COMPONENT *2	S-VIDEO	×
	Used	×	○	○	○	×	COMPONENT *2	S-VIDEO	VIDEO *2
	Not used	×	○	○	○	×	COMPONENT *1	–	VIDEO
	–	○	×	×	×	HDMI	×	×	×
	–	○	×	×	○	HDMI	×	×	VIDEO
	–	○	×	○	×	HDMI	×	S-VIDEO	×
	Used	○	×	○	○	HDMI	×	S-VIDEO	VIDEO *2
	Not used	○	×	○	○	HDMI	×	–	VIDEO
	–	○	○	×	×	HDMI	COMPONENT	×	×
	–	○	○	×	○	HDMI	COMPONENT *1	×	VIDEO
	–	○	○	○	×	HDMI	COMPONENT *2	S-VIDEO	×
	Used	○	○	○	○	HDMI	COMPONENT *2	S-VIDEO	VIDEO *2
	Not used	○	○	○	○	HDMI	COMPONENT *1	–	VIDEO

○ : Signal input
 × : No signal

× : Not output
 *1 : On screen display superimposed on video signal and output.
 *2 : On screen display superimposed on S-Video signal and output.
 COMPONENT : On screen display only displayed for **SYSTEM SETUP**, **SURROUND PARAMETER** and **ON SCREEN** buttons.
 HDMI : The on screen display is displayed when the "Analog to HDMI convert" is set to "ON".

The analog video to HDMI conversion function

- The AVR-987's video up-conversion function lets you output analog video input signals (component – 480i/576i, 480p/576p, 1080i or 720p; S-Video and composite video – 480i/576i) to the HDMI monitor output terminal.
- On the AVR-987, it is possible to convert 480i/576i component video, S-Video and composite video input signals to 480p/576p format and output them from the HDMI monitor output terminal.



- The resolutions with which the monitor is compatible can be checked using the **STATUS** button on the main unit or the **ON SCREEN** button on the remote control unit.
- It is not possible to down-convert from HDMI input signals to the component, S-Video or composite video monitor output terminals.
- If you do not want to use the function for converting analog video signals to HDMI signals, select "OFF" for "Analog to HDMI Convert" at "Setting the HDMI Out Setup" (page 51).
- Video down conversion to the MAIN ZONE's monitor output is only possible when the component video input resolution is 480i (interlaced standard definition video – NTSC format, for North America) or 576i (interlaced standard definition video – PAL format, for Europe and other countries).
- To set the video conversion function for the MAIN ZONE to "OFF" (page 50).

On screen display for component video outputs and HDMI output

- When viewing component video signals or HDMI signals via the AVR-987, the on screen display is displayed on the monitor when the "System Setup" operations are performed and when the remote control unit's **ON SCREEN** button is operated.
- When only component video signals are input to the AVR-987, the characters of the on screen display are not displayed over the picture.

Connecting equipment with HDMI terminals
[To convert analog video signals to HDMI signals]

- The AVR-987 is equipped with a function for converting analog video signals into HDMI signals. You can do this by either a component or a video or a S-Video connection.
- Audio signals are not output from the HDMI monitor output terminal, so also make analog or digital audio connections. To play sound using digital audio connections, assign the digital terminal (coaxial or optical) at "Setting the Digital In Assignment" (🔧 page 47).

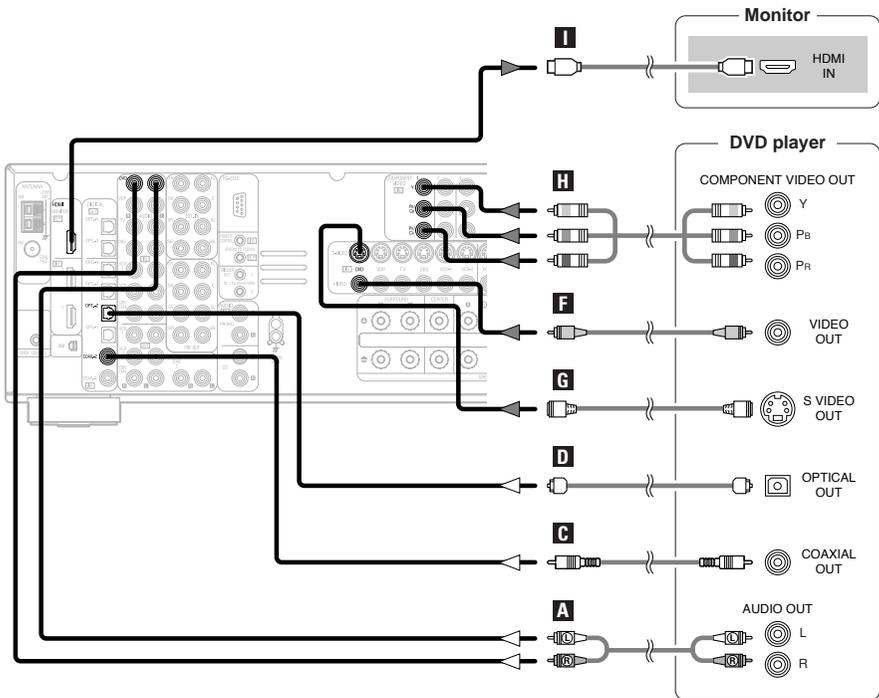

- When "OFF" is set at "i/p Convert" under "Setting the HDMI Out Setup", use a monitor compatible with input resolutions of 480i/576i.
- If your monitor is not equipped with an HDMI terminal, connect the AVR-987 to the monitor using the component video, S-Video, or composite video terminals.

Connecting a TV tuner

- For best picture quality choose the component video connection to your TV tuner. S-Video and composite video outputs are also provided if your TV tuner does not have component video inputs.
- To connect the digital audio output from the TV tuner, you can choose from either the coaxial or the optical connections. If you choose to use the coaxial or the optical connection, it needs to be assigned. For more information about Digital Input Assignment (🔧 page 47).

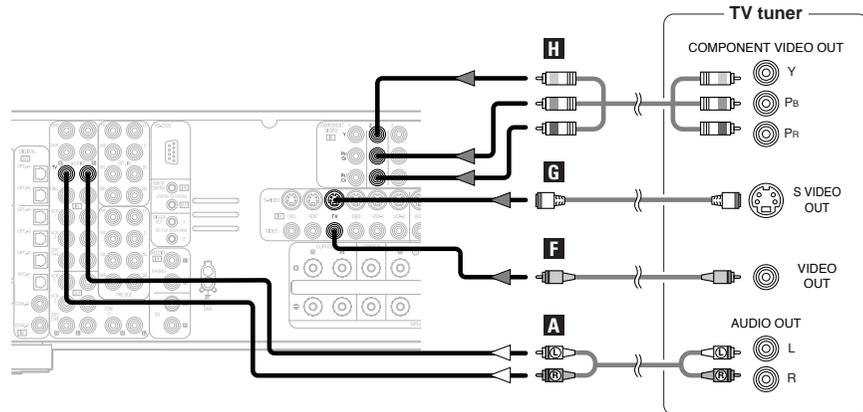

Connecting a DBS tuner

- For best picture quality choose the component video connection to your DBS tuner. S-Video and composite video outputs are also provided.
- To connect the digital audio output from the DBS tuner, you can choose from either the coaxial or the optical connections. If you choose to use the coaxial connection, it needs to be assigned. For more information about Digital Input Assignment (🔧 page 47).

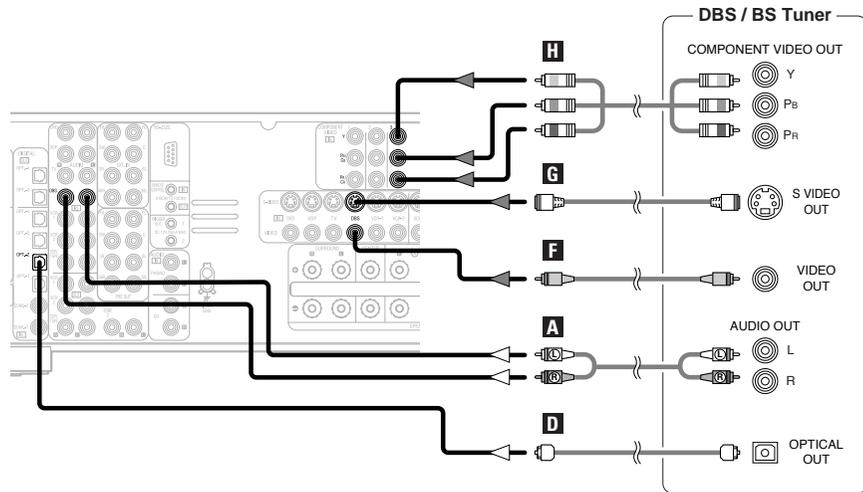

Connecting Other Sources

Connecting the external inputs (EXT. IN) terminals

- These terminals are for inputting multi-channel audio signals from an outboard decoder, or a component with a different type of multi-channel decoder, such as a DVD-Audio player, or a multi-channel Super Audio CD player, or other future multi-channel sound format decoder.
- The video signal connection is the same as that for a DVD player (page 8).
- For instructions on playback using the external input (EXT. IN) terminals (page 23).

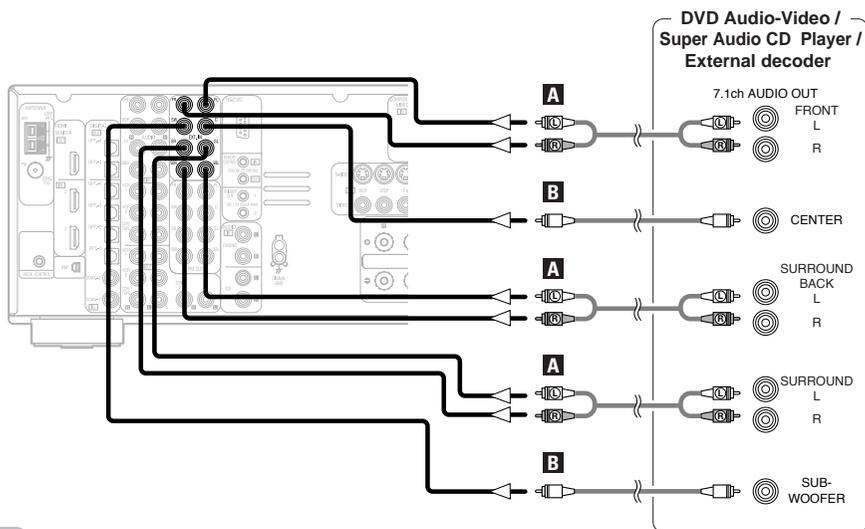

- With discs on which special copyright protection measures have been taken, however, the digital signals may not be output from the DVD player. In this case, connect the DVD player's analog multi-channel output to the AVR-987's EXT. IN terminals for playback. Also refer to your DVD player's operating instructions.

Connecting a video camera or video game

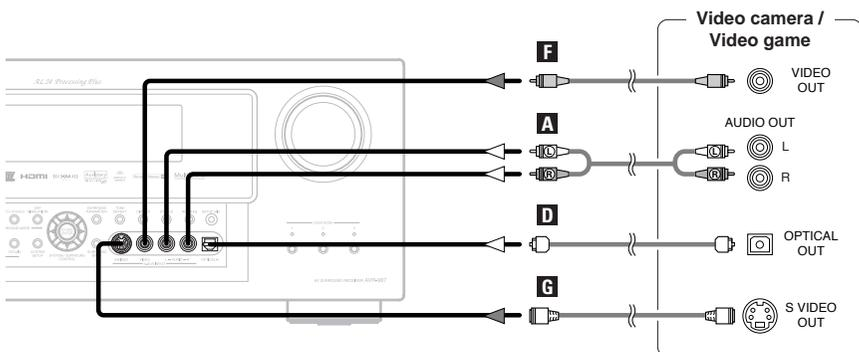

Connecting Other Sources

Connecting a CD player

To connect the digital audio output from the CD player, you can choose from either the coaxial or optical connections. If you choose to use the optical connection, it needs to be assigned. For more information about Digital Input Assignment (page 47).

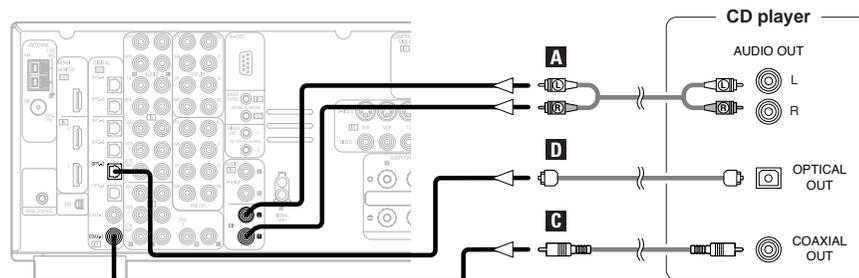

Connecting a turntable

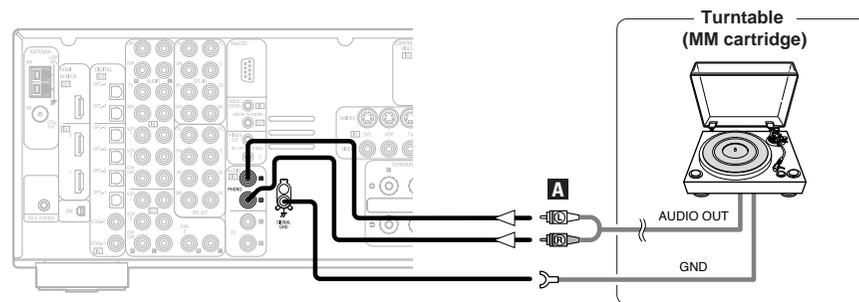

- The phono input can accept signals from moving magnet (MM) and high output moving coil (MC) phono cartridges. If your turntable is equipped with a low output MC cartridge, you will need to use a separate MC head amplifier or step-up MC transformer.

NOTE:

- If humming or other noise is generated when the ground wire is connected to the SIGNAL GND terminal, disconnect the ground wire.

Connecting Other Sources

Connecting a DVD recorder

- For best picture quality choose the component video connection to your DVD recorder. S-Video and composite video outputs are also provided. If you choose to use the component video connection, it needs to be assigned. For more information about Component Input Assignment (see page 50).
- If you wish to perform analog dubbing from a digital sources, such as a DVD recorder to an analog recorder such as a cassette deck, you will needs connect the analog inputs and outputs as shown below, in addition to the digital audio connections.

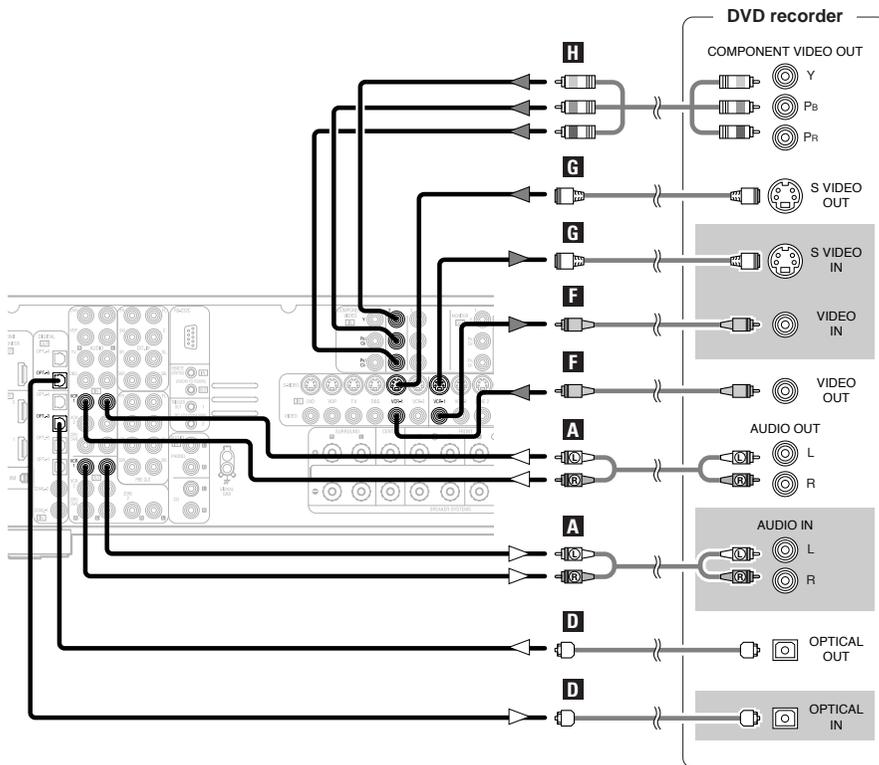

- When recording to a DVD recorder, it is necessary that the type of cable used with the playback source equipment be the same type that is connected to the AVR-987 VCR-1 (to 2) OUTPUT terminal.

Example: VCR-1 IN → S-Video cable : VCR-1 OUT → S-Video cable
 VCR-1 IN → Video cable : VCR-1 OUT → Video cable

NOTE:

- Do not connect the output of the component connected to the OPTICAL 3 OUT terminal on the AVR-987's rear panel to any terminal other than the OPTICAL 3 IN terminal.

Connecting Other Sources

Connecting a VCR

There are 2 sets of video deck (VCR) terminals, so 2 video decks can be connected for simultaneous recording or video copying.

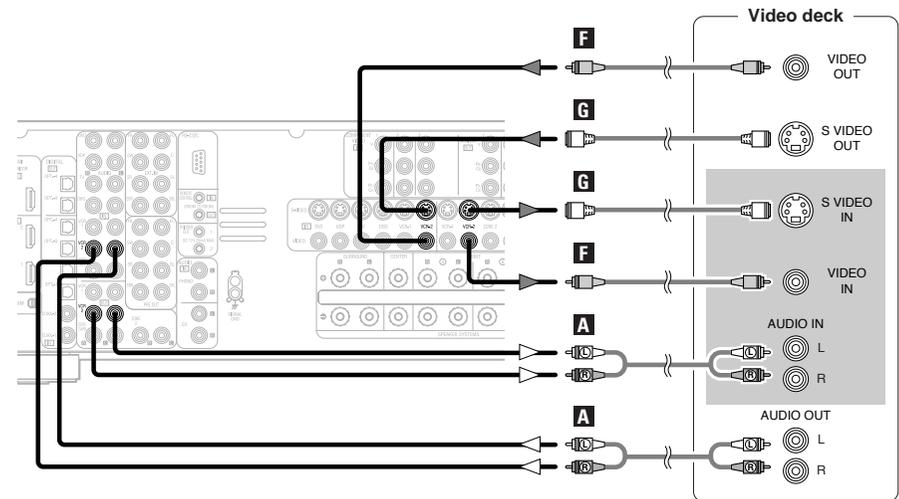

- When recording to a VCR, it is necessary that the type of cable used with the playback source equipment be the same type that is connected to the AVR-987 VCR-1 (to 2) OUTPUT terminal.

Example: VCR-2 IN → S-Video cable : VCR-2 OUT → S-Video cable
 VCR-2 IN → Video cable : VCR-2 OUT → Video cable

Connecting a tape deck

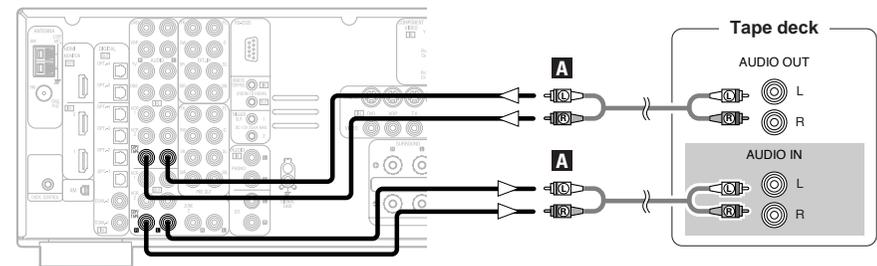

Connecting Other Sources

Connecting a CD recorder or MD recorder

If you wish to perform analog dubbing from a digital source, such as a CD or MD recorder to an analog recorder such as a cassette deck, you will need to connect the analog inputs and outputs as shown below, in addition to the digital audio connections.

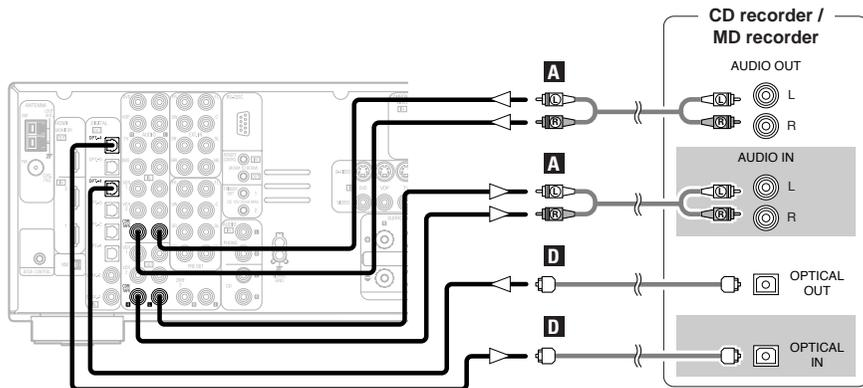

NOTE:

- Do not connect the output of the component connected to the OPTICAL 4 OUT terminal on the AVR-987's rear panel to any terminal other than the OPTICAL 4 IN terminal.

Connecting equipment with HDMI terminals

- A simple 1-cable connection (using a commercially available cable) with a device having an HDMI (High-Definition Multimedia Interface) terminal allows digital transfer of the digital images of DVD-Video and other sources, and the multi-channel sound of DVD-Audio and DVD-Video.
- To provide audio output from AVR-987's audio output terminal, select "Amp" at the "HDMI In Assign". To provide audio output from the TV, select "TV" at the "HDMI In Assign" (page 49, 50).

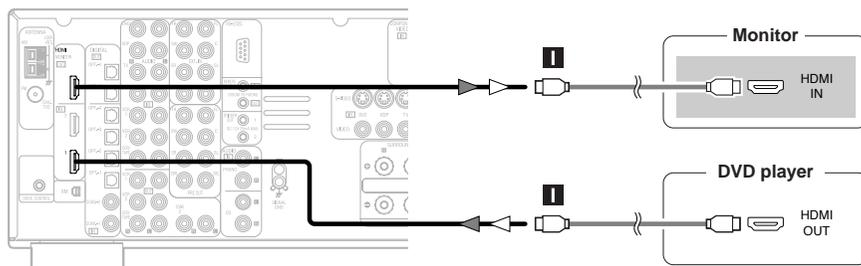

Connecting Other Sources

Copyright Protection System

To play back the digital video and audio of DVD-Video and DVD-Audio through an HDMI/DVI-D connection, both the connected player and monitor are required to support a copyright protection system called HDCP (High-bandwidth Digital Content Protection System). HDCP is copy protection technology that comprises data encryption and authentication of the partner equipment. The AVR-987 supports HDCP. Please see the user's manual of your video display for more information about this.

Input signals		
DVD-Video	LINEAR PCM	○
	Dolby Digital	○
	DTS	○
DVD-Audio	LINEAR PCM PACKED PCM (with CPPM / without CPPM)	○
CD	LINEAR PCM	○
Super Audio CD	Multi area	×
	Stereo area	×
	CD area	○

※ The AVR-987 is HDMI Ver. 1.1 compatible.



- If your digital monitor or DVD player only supports DVI-D, please obtain and use an HDMI-DVI conversion cable or adaptor, available from your dealer.

NOTE:

- The audio signals on the multi/stereo area of Super Audio CDs are not output. If the Super Audio CD is a hybrid CD, only the audio signals in the CD area are output.
- Use a compatible player to play DVD-Audio discs that are copyright protected by CPPM.
- Among the devices that support HDMI, some devices can control other devices via the HDMI terminal; however, the AVR-987 cannot be controlled by another device via the HDMI terminal.
- The audio signals from the HDMI terminal (including the sampling frequency and bit length) may be limited by the equipment that is connected.
- The video signals are not output properly if a device not compatible with HDCP is used.
- When "OFF" is set at "i/p Convert" under "Setting the HDMI Out Setup", use a monitor compatible with input resolutions of 480i/576i.
- The video signals input from the HDMI input terminals are output to the HDMI monitor with their original resolution, so the image will not be displayed if the resolutions of the input signal and the monitor being used are not matched. In this case, change the setting of the resolution on the source device (player) to one which the monitor can handle.
- For stable signal transfer, we recommend using cables that are a maximum of 5 meters in length.

Connections with an HDMI/DVI-D conversion cable (adapter)

- The HDMI video stream signals (video signals) are theoretically compatible with DVI-D. When connecting to a monitor, etc., equipped with DVI-D terminals, it is possible to connect using an HDMI/DVI-D conversion cable, but depending on the combination of devices used the image might not be output.
- When using an HDMI/DVI-D conversion adapter, the image may not be output properly due to poor contact with the connected cable, etc..

Connecting the antenna terminals

An FM antenna cable plug can be connected directly.

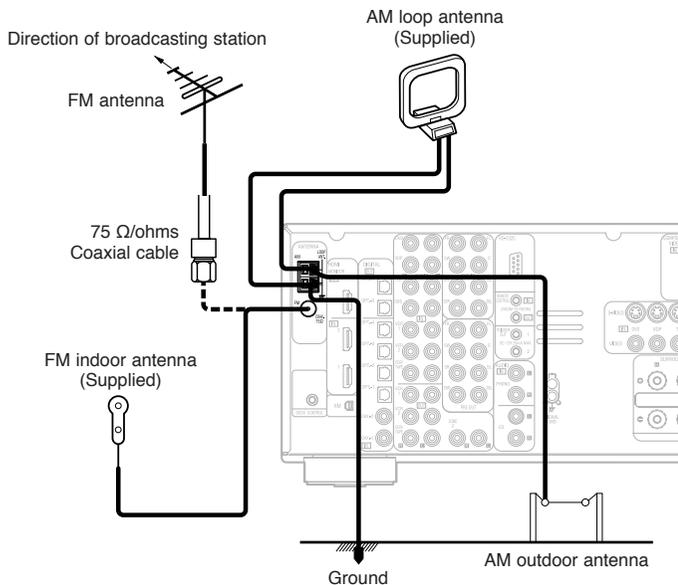

Connecting the XM terminal

- AVR-987 is the XM Ready® receiver. You can receive XM Satellite Radio® by connecting to the XM Connect-and-Play™ (sold separately) and subscribing the XM service.
- Plug the XM Connect-and-Play antenna into XM connector on the rear panel.
- Position the XM Connect-and-Play antenna near a south-facing window to receive the best signal. For details, see "XM Satellite Radio" (page 36, 37).
When making connections, also refer to the operating instructions of the XM Connect-and-Play antenna.

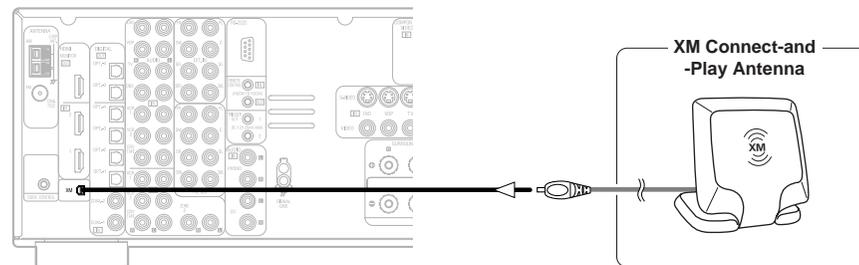

NOTE:

- Keep the power supply cord unplugged until the XM Connect-and-Play antenna connection have been completed.

AM loop antenna assembly

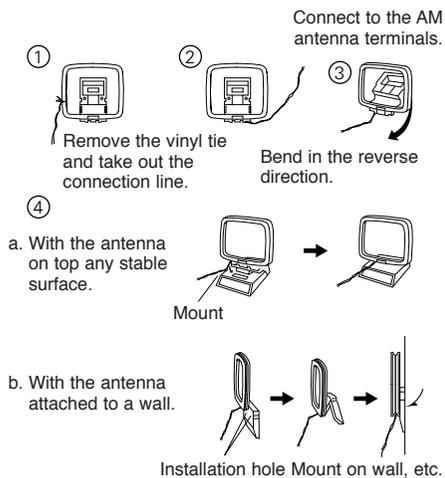

Connection of AM antennas

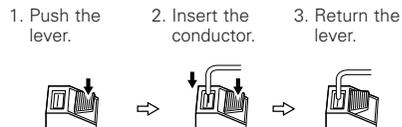

Note to CATV system installer:

This reminder is provided to call the CATV system installer's attention to Article 820-40 of the NEC which provides guidelines for proper grounding and, in particular, specifies that the cable ground shall be connected to the grounding system of the building, as close to the point of cable entry as practical.

NOTE:

- Do not connect 2 FM antennas simultaneously.
- Even if an external AM antenna is used, do not disconnect the AM loop antenna.
- Make sure the AM loop antenna lead terminals do not touch metal parts of the panel.

Connecting Other Sources

Connecting the iPod®

When using an iPod, you must Connect the DENON original Control Dock for iPod and the DOCK CONTROL jack on the AVR-987 with a mini-jack and assign the iPod to any AUDIO and/or S-VIDEO terminal(s).

The diagram below shows an example of connections for when the iPod is assigned to the VDP terminal.

- ※ For instructions on assigning the iPod to a specific terminal, see "Setting the iPod Assignment" (page 47).
- ※ For instructions on playing the iPod, see "Playing the iPod" (page 39).

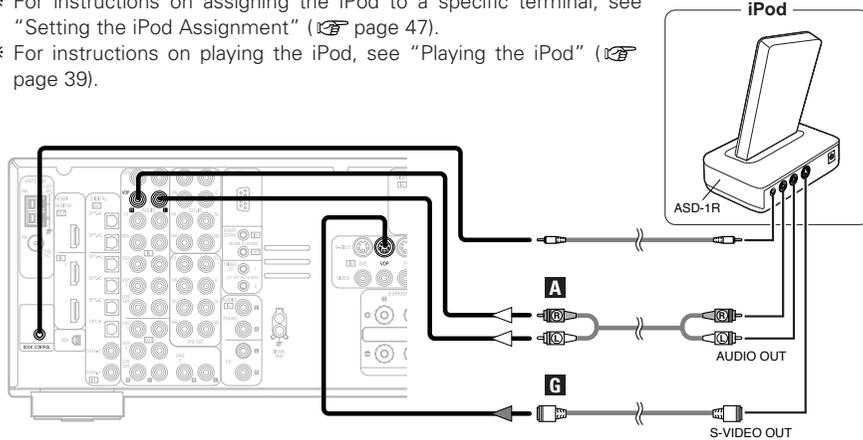

- The optional standard Control Dock for iPod is DENON ASD-1R sold separately.

Connecting the RS-232C terminal

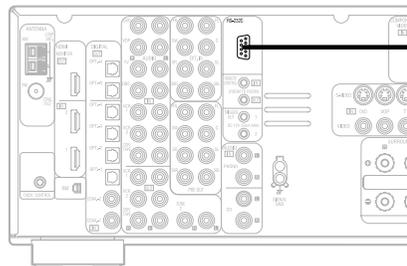

This is a control expansion terminal for factory use only. Consult your dealer for details.

Perform the following operation before using an external controller connected to the RS-232C terminal:

1. Press the **ON/STANDBY** button on the main unit and set the unit to the operating mode.
2. Perform the operation to turn off the power from the external control.
3. Check that the product has been set to the standby mode.

After checking the above, check the connections of the external controller. Operation is possible.

Connecting Other Sources

Connecting the TRIGGER OUT jacks

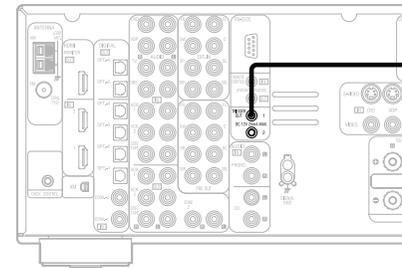

Turn the DC 12 V voltage on and off for the individual functions and surround modes. For details, see "Setting the Trigger Out" (page 55).

Connecting the MULTI ZONE terminals

- ※ For instructions on operations using the MULTI ZONE functions (page 40, 41).

ZONE2 out connections

- If another pre-main (integrated) amplifier is connected, the ZONE2 out (fixed level) terminals can be used to play a different program source in ZONE2 the same time (page 40).

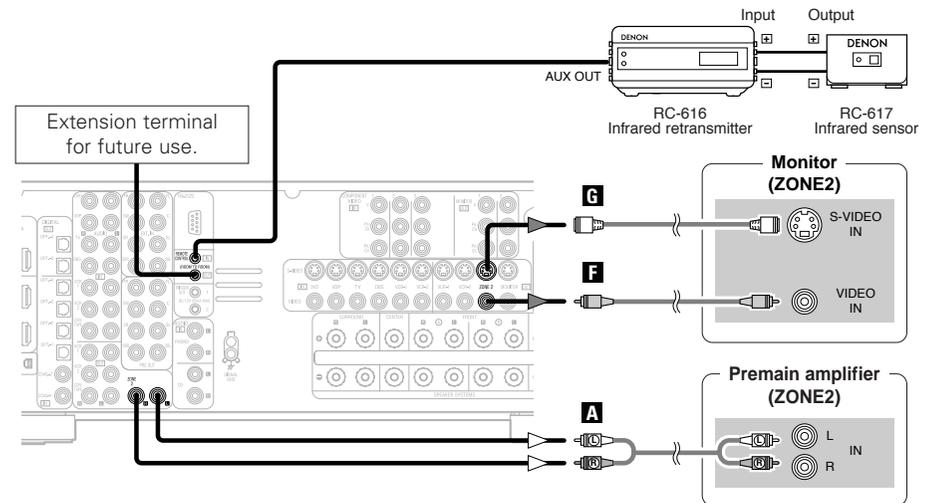

- For the AUDIO output, use high quality pin-plug cables and wire in such a way that there is no humming or noise.
- For instructions on installation and operation of separately sold devices, refer to the devices' operating instructions.

ZONE2 speaker out connections

- When the surround back's power amplifier is assigned to the ZONE2 output channel at "Power Amp Assign" in the "System Setup Menu", the surround back speaker terminals can be used as the ZONE2 speaker out terminals (see page 54).
- The connections diagram below is an example for when the surround back speaker is assigned to the ZONE2 stereo 2 channel. In this case, surround back speaker out can not be used for MAIN ZONE.

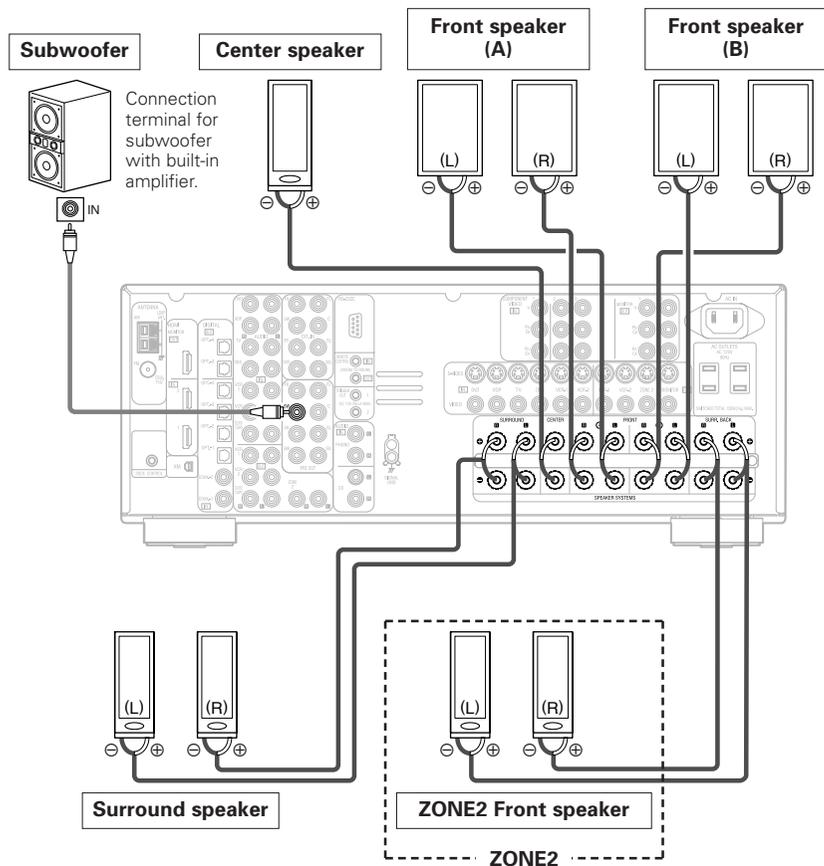

Connecting the PRE OUT terminals

- Use these terminals if you wish to connect external power amplifier(s) to increase the power of the front, center, surround and surround back sound channels, or for connection to powered loudspeakers.
- When using only one surround back speaker, connect it to the left channel.

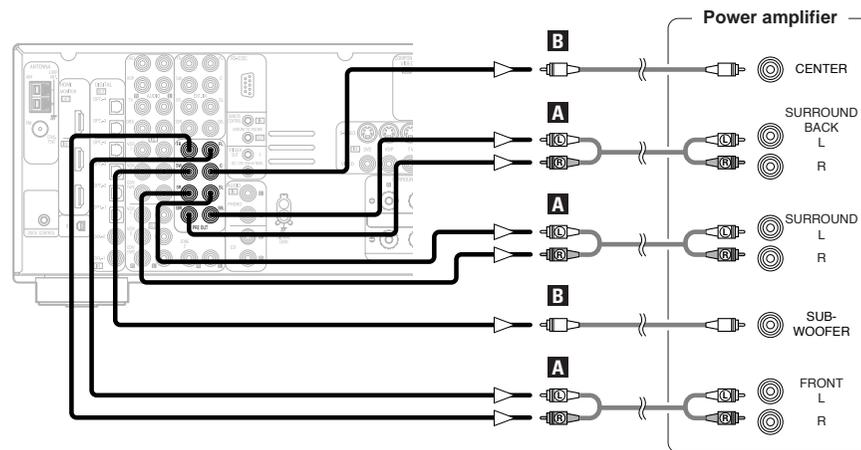

Connecting the power supply cord

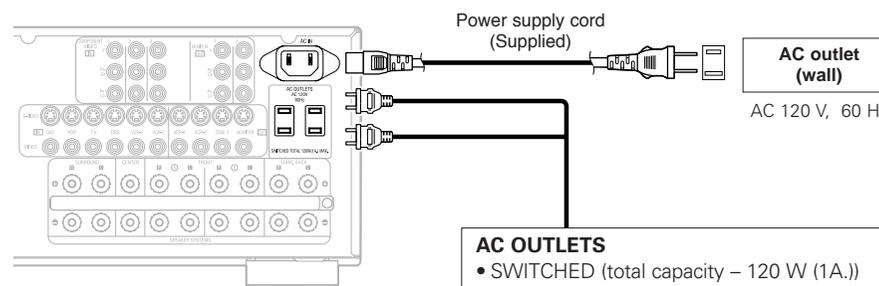

NOTE:

- Insert the plugs securely. Incomplete connections will result in the generation of noise.
- Only use the AC OUTLETS for audio equipment. Never use it for hair driers, monitors or other electrical appliances.

AC OUTLETS

- SWITCHED (total capacity – 120 W (1A.))
The power to the outlet is turned on and off in conjunction with the **POWER** switch on the main unit, and when the power is switched between on and standby from the remote control unit. No power is supplied from this outlet when this unit's power is at standby. Never connect equipment whose total power consumption exceeds 120 W (1A.).

Basic Operation

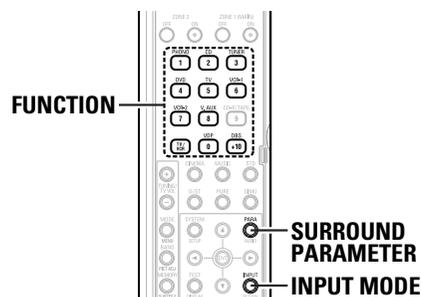
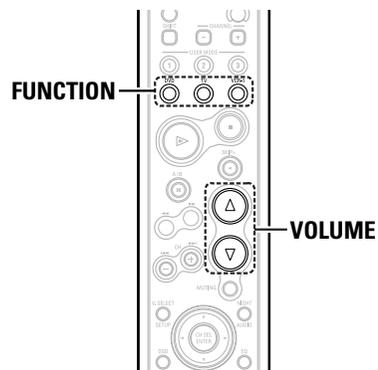
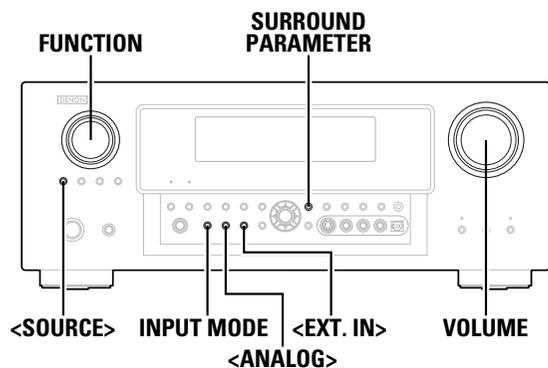

About the button names in this explanation

< > : Buttons on the main unit
[] : Buttons on the remote control unit

Button name only :

Buttons on the main unit and remote control unit

Playing the input source

1 Use **FUNCTION** to select the input source you want to play.

※ To select the input source when ZONE2/REC SELECT, VIDEO SELECT or TUNING PRESET is selected, press <SOURCE> then operate <FUNCTION>.

2 Press **INPUT MODE**.



※ Press <ANALOG> to select "ANALOG", <EXT. IN> to select "EXT. IN".

AUTO (All auto mode):

The type of input signal is detected and the AVR-987's surround mode is switched automatically. Can be selected for sources for which the "Digital In Assign" (page 47) is made.

The mode switches automatically to DTS/ Dolby Digital/ PCM. The input switches to the analog input terminals is no digital signals are being input.

PCM (exclusive PCM signal playback mode) and

DTS (exclusive DTS signal playback mode):

Played when the various signals are input. Noise may be generated when a mode different from the input signal is set.

ANALOG (exclusive analog audio signal playback mode) and

EXT. IN (External decoder input terminal selection mode):

The signals input to the various input terminals are played.

※ To lower the subwoofer channel level in the EXT. IN mode, press **SURROUND PARAMETER** and select "SW. ATT". For some players the playback level of the SW channel may be seen strong. If so, set to "ON".

3 Start playback on the selected component.

※ For operating instructions, refer to the component's manual.

4 Use **VOLUME** to adjust the volume.

- The volume level is displayed on the master volume level display.

※ The volume can be adjusted between the range of -80 ~ 0 ~ 18 dB. Depending on the channel level settings and the different surround mode settings and when in the down-mix mode, it may not be possible to adjust the volume to 18 dB.



- Canceling the EXT. IN mode:
Press **INPUT MODE** or <ANALOG> to switch to the desired input mode.
- To use the EXT. IN mode together with a picture, select the input source to which the video signal is connected first, then set the input mode.
- The "DIG." indicator lights when digital signals are being input properly. If the "DIG." indicator does not light, check whether the "Digital In Assign" (page 47) and connections are correct.

NOTE:

- When the input mode is set to the external input (EXT. IN), the surround mode cannot be set.
- In play modes other than the external input mode, the signals connected to these terminals cannot be played.

Cautions when playing DTS sources:

- For DTS sources, be sure to connect the device to the digital input terminal and set "AUTO" or "DTS" for the input source. Noise will be generated if you play in the ANALOG or PCM mode.
- When playing DTS signals in the "AUTO" mode, noise may be generated when you first start playing and during searching. If so, play in the "DTS" mode.

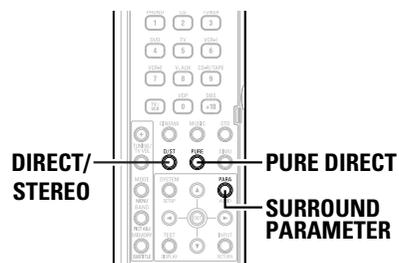
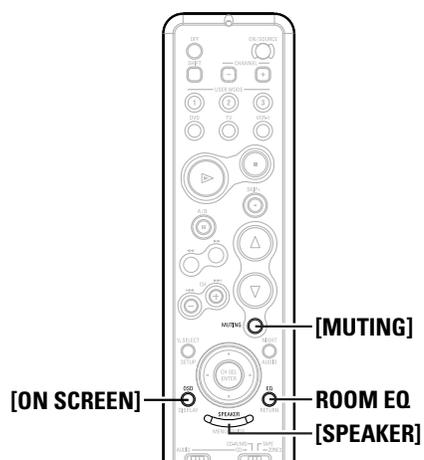
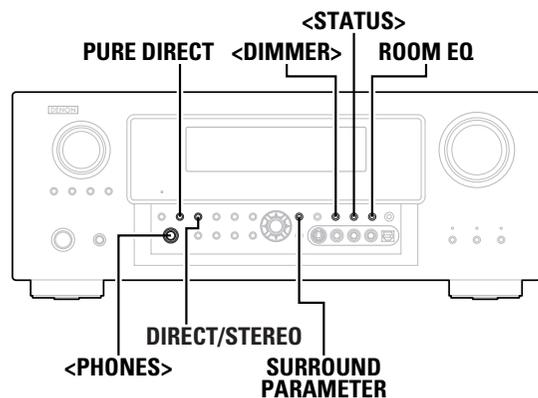

About the button names in this explanation
 < > : Buttons on the main unit
 [] : Buttons on the remote control unit
Button name only :
 Buttons on the main unit and remote control unit

Selecting the room equalizer mode

The room equalizer function offers 3 correction curves: "Audyssey", "Front" and "Flat". These modes can be selected after performing the auto setup procedure.

Press ROOM EQ.



- The "MultEQ XT" indicator lights green when "Audyssey" is selected, red when "Front" or "Flat" is selected.

- ※ The indicator lights red if the speaker settings are changed after the auto setup measurements have been made (🔧 page 56 ~ 59).

Audyssey, Front, Flat:

See page 60.

Manual:

Selects the setting value that was set in the Manual Equalizer Setup (🔧 page 53, 54).

Turning the sound off temporarily (MUTING)

Press [MUTING].

- ※ You can adjust the muting level (🔧 page 55).



- Canceling MUTING mode:
To cancel the muting mode, either press [MUTING] or adjust the volume.

Listening over headphones

Connect the headphones to <PHONES>.

- No sound is produced from the speakers automatically.

NOTE:

- To prevent hearing loss, be careful not to raise the volume level excessively when using headphones.

Switching the front speakers

Press [SPEAKER].



Checking the currently playing program source, etc.

On screen display

Press [ON SCREEN].

- The current program source and various settings are displayed on the monitor screen.

Front panel display

Press <STATUS>.

- The current program source and various settings are indicated on the display.

Switching the brightness of the display

Press <DIMMER>.

- ※ The brightness of the display can be adjusted in 3 steps. The display can also be turned off.

Using the surround modes

Types of surround modes and their features

The AVR-987 is equipped with many surround modes. We recommend using the surround modes as described below in order to achieve the maximum effect for the specific signal source.

※  is a 6.1-channel/7.1-channel surround mode.

Sources recorded in Dolby Digital EX

DOLBY DIGITAL EX / +PLIIx* (📖 page 26)

• This mode is optimized for playing sources recorded in Dolby Digital EX.

Sources recorded in DTS-ES

DTS-ES DSCRT 6.1 / MTRX 6.1, +PLIIx*

(📖 page 26)

• This is the optimum mode for playing sources recorded in DTS-ES.

**Dolby Digital or DTS Surround (5.1 ch sources)
2 ch sources recorded in Dolby Surround**

WIDE SCREEN

(📖 page 32, 33)

• Effective for 2-channel sources recorded in Dolby Surround or for 7.1-channel playback with 5.1-channel sources.

**DOLBY DIGITAL / DOLBY DIGITAL+PLIIx* /
DTS SURROUND / DTS 96/24 / DTS+PLIIx* /
DTS+NEO:6**

(📖 page 26)

• This mode is optimized for playing 5.1-channel or 7.1-channel music.
• For Dolby Surround recording sources, Dolby Pro Logic II playback is conducted.

**Sources recorded in stereo
Sources recorded in monaural**

PURE DIRECT

• Use this mode to play analog input music sources with extremely high quality.

DIRECT / STEREO

• Effective for achieving pure playback.
• If there is no need for tone control or distribution of the low frequencies in function of the speaker configuration, select the DIRECT mode to achieve the best sound quality.

DENON Original Surround Modes (📖 page 32, 33)

• Select these for 7.1-channel playback with sources recorded in stereo or monaural.
• The effects are different for each of the surround modes. Select the one most suited for the source being used.

DTS NEO:6

(📖 page 28)

• This is a surround mode for playing 6.1- or 7.1-channel stereo sources developed by Digital Theater Systems.
• One of 2 playing modes, MUSIC (for music sources) or CINEMA (for movie sources), can be selected according to your preferences.

DOLBY PRO LOGIC IIx*

(📖 page 27)

• Developed by Dolby Laboratories, this surround mode provides 7.1-channel surround sound with conventional stereo (2-channel) sources.
• Select CINEMA mode for movie surround soundtracks, MUSIC for music sources, and GAME for 2-channel game box audio sources.



- Surround modes marked with an asterisk (*) cannot be used when the surround back speaker is set to "NONE".
- The "+PLIIx Cinema" mode cannot be selected when only one surround back speaker is being used.

**Selecting the play mode
(PURE DIRECT / DIRECT / STEREO)**

The AVR-987 is equipped with 3 2-channel playback modes exclusively for music. Select the mode to suit your tastes.

PURE DIRECT mode

This mode reproduces the sound with extremely high quality. The audio signals do not pass through the tone circuits, etc., and the display and surrounding circuits that could affect the audio signals are turned "OFF".

Press PURE DIRECT.

DIRECT mode

This mode is for playing with high quality sound. The audio signals are transmitted directly, without passing through the tone circuits, etc.

Press DIRECT/STEREO to select "DIRECT".

DIRECT ←→ STEREO

※ When press **SURROUND PARAMETER**:
The subwoofer output can be controlled directly.

STEREO mode

Use this mode to adjust the tone and achieve the desired sound.

Press DIRECT/STEREO to select "STEREO".



- The system setup function cannot be used when the PURE DIRECT mode is set. To use the system setup function, cancel the PURE DIRECT mode.
- If the HDMI input terminal is selected, video outputs are output in the PURE DIRECT mode.
- The channel level and surround parameters in the PURE DIRECT mode are the same as in the DIRECT mode.

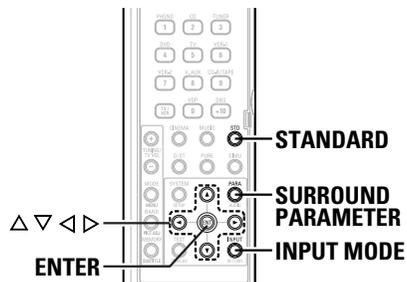
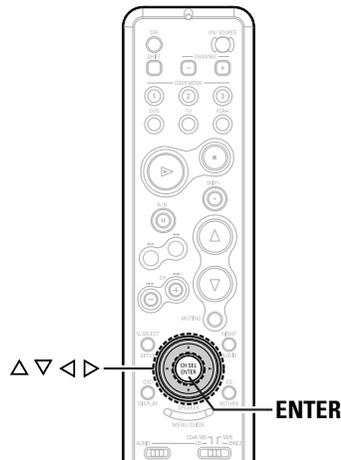
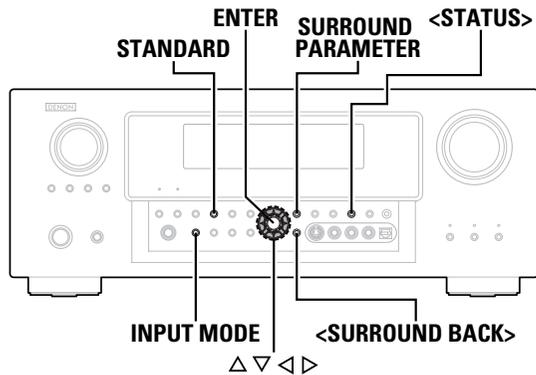

Selecting the Dolby Digital and DTS Surround mode (only with digital input)

- 1** Select an input source for which digital (COAXIAL, OPTICAL etc.) is set (☞ page 47 or 49 ~ 50).
- 2** Press **INPUT MODE** to select "AUTO".
- 3** Press **STANDARD** to select "STANDARD".
- 4** Play a program source with the mark.
 - "DIGITAL" or "DTS" lights, depending on the source.
- 5** Press **SURROUND PARAMETER**.
 - ※ The surround back channel can be switched on and off using <SURROUND BACK>.
- 6** Press Δ ∇ to select the item, then press \triangleleft \triangleright to set.

CINEMA EQ.:

Use this if movie dialogues sound harsh to lower the treble sound.

- ※ Effective source / mode
Dolby Pro Logic IIx / Dolby Pro Logic / Dolby Digital / DTS Surround / DTS NEO:6 / WIDE SCREEN

D.COMP.:

The dynamic range is compressed. Select one of 4 modes: "OFF", "LOW", "MID" (middle) or "HI" (high).

- ※ Effective source / mode
Dolby Digital / DTS (For DTS sources, only displayed for compatible software.)

LFE:

To play the various types of software properly, we recommend setting to the values shown below.

- To play Dolby Digital software: "0 dB"
- To play DTS movie software: "0 dB"
- To play DTS music software: "-10 dB"

STONE:

Adjust the tone control.

- ※ Can be set in surround modes other than direct mode.
- ※ Can be set separately for the different surround modes. (Adjusted together for the Dolby/DTS SURROUND modes.)

SB CH OUT:

Select the play mode or surround back channel playback method.

(1) For multi-channel sources

- **SB OFF (OFF):**
Not played.
- **NON MTRX:**
Surround channel signal played.
- **MTRX ON:**
Surround channel signal played with digital matrix processing.
- **ES MTRX:**
DTS signal played with digital matrix processing.
- **ES DSCRT:**
Signal included in DTS-ES discrete 6.1-channel sources played.
- **PLIIx CINEMA:**
Decoded in Dolby Pro Logic IIx Cinema mode, surround back signal played.
※ Set the surround back speaker to "2spkr" at "Speaker Configuration" (☞ page 56, 57)
- **PLIIx MUSIC:**
Decoded in Dolby Pro Logic IIx Music mode, surround back signal played.
※ Set the surround back speaker to "1spkr" or "2spkr" at "Speaker Configuration" (☞ page 56, 57)

(2) For 2-channel sources

- **OFF:** Not played.
- **ON:** Surround channel signal played.
- ※ Can also be operated using <SURROUND BACK>.

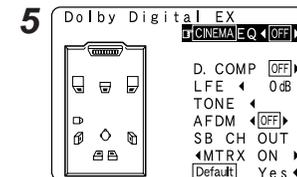

Example: Dolby Digital

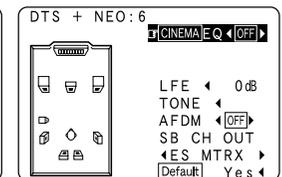

Example: DTS

About the button names in this explanation
 \triangleleft \triangleright : Buttons on the main unit
 [] : Buttons on the remote control unit
Button name only :
 Buttons on the main unit and remote control unit

AFDM (Auto Flag Detect Mode):

• ON:

When software including Dolby Digital EX or DTS-ES 6.1-channel identification signals is played, 6.1-channel playback is performed automatically. The surround mode is set according to the program source being played. The "SB CH OUT" parameter on the surround parameters screen cannot be selected.

• OFF:

Not detected automatically. The surround mode can be selected freely.

Example: When playing Dolby Digital software (with EX flag)

- ① When "AFDM" is "ON", the "DOLBY DIGITAL + PLIIx CINEMA" mode is set automatically.
- ② To play in the Dolby Digital EX mode, set "AFDM" to "OFF" and select "MTRX ON" at "SB CH OUT".

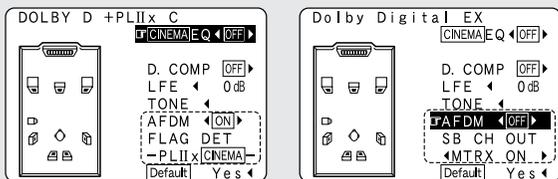

Example: ①

Example: ②

※ Some discs recorded in Dolby Digital EX do not include EX flag. If the playing mode does not switch automatically when the AFDM turns "ON" during playback, manually set "SB CH OUT" to "PLIIx Cinema" or "MTRX ON".

7 Press ENTER or SURROUND PARAMETER.



• Select "Default Yes" and press < to reset all the settings.

■ Dialog normalization function

This operates automatically when playing Dolby Digital sources. This is a function for automatically correcting the standard signal level for different program sources. The correction value can be checked by pressing <STATUS>.

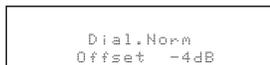

The numbers are the correction value when corrected to the standard level.

Selecting the Dolby Pro Logic IIx (Pro Logic II) mode

It is possible to play analog input signals and digital input signals (2-channels) in the surround mode. This mode is optimal for playing program sources recorded in Dolby Surround.

1 Press STANDARD to select "DOLBY PLIIx".

DOLBY PLIIx ← → DTS NEO:6

2 Play a program source.

3 Press SURROUND PARAMETER.

4 Press <> to select the play mode.

CINEMA:

This mode is suited for playing movie sources recorded in Dolby Surround and general sources recorded in stereo.

MUSIC:

This mode is suited for playing stereo music signals in the surround mode. With music signals, the sound field expansion differs according to the type of music, the recording conditions (live/studio), etc.. Because of this, the MUSIC mode offers a number of optional parameters for further adjusting the sound field.

GAME:

This mode is optimum for games. The GAME mode can only be used for 2-channel audio sources.

PL:

This mode is compatible with conventional Dolby Pro Logic sources.

※ Optional parameters can only be set in the MUSIC mode. Select "OPTIONS", then press <. Press ENTER to return to the previous screen.

5 When "MUSIC" is selected:

Press Δ ▽ to select the item, then press < > to set.

PANORAMA:

This is effective when the surround effect seems weak.

DIMENSION:

This shifts the center of the sound field image to the front or surround side. This compensates for when the sound field image seems unbalanced. (0 to 6, default : 3)

CENTER WIDTH:

A natural expansion to the front can be achieved by adjusting the center signal's output balance between the center and front channels. (0 to 7, default : 3)

6 Press ENTER or SURROUND PARAMETER.

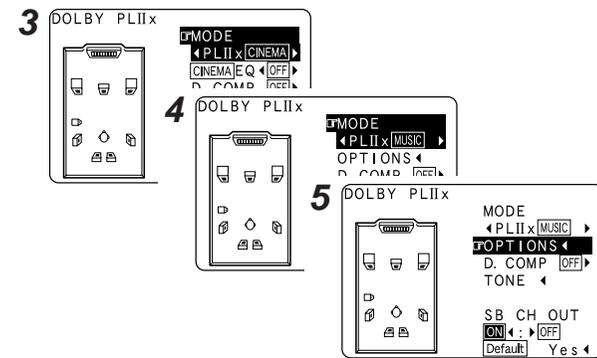

(When "MUSIC" is selected)

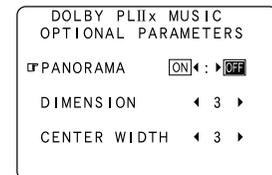

(When "OPTIONS" is selected)

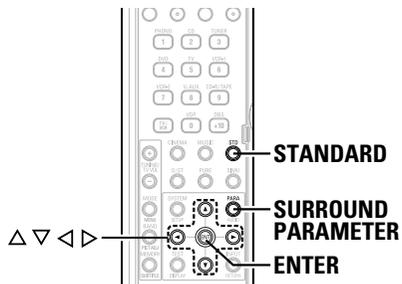
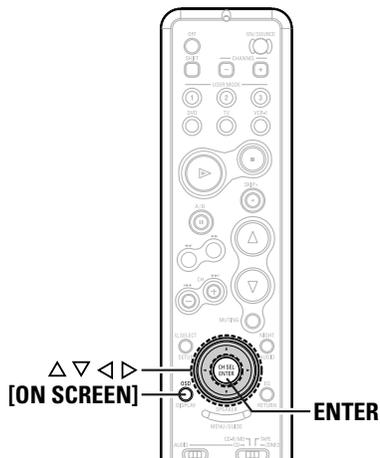
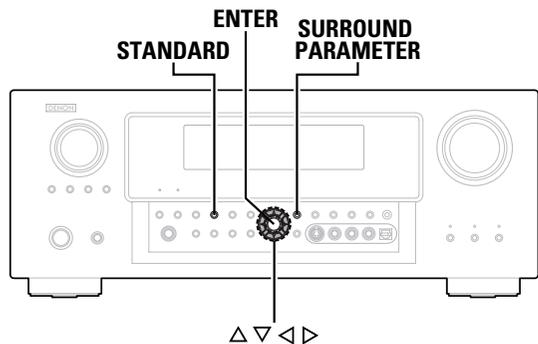

About the button names in this explanation
 < > : Buttons on the main unit
 [] : Buttons on the remote control unit
Button name only :
 Buttons on the main unit and remote control unit

Selecting the DTS NEO:6 mode

It is possible to play analog input signals and digital input signals (2-channels) in the surround mode.

- 1 Press STANDARD to select “DTS NEO:6”.**
 DOLBY PLIIx ←→ DTS NEO:6
- 2 Play a program source.**
- 3 Press SURROUND PARAMETER.**
- 4 Press <> to select the play mode.**
CINEMA:
 This mode is optimum for playing movies. Decoding is performed with emphasis on separation performance to achieve the same atmosphere with 2-channel sources as with 6.1-channel sources.
MUSIC:
 This mode is suited mainly for playing music.
- 5 When “MUSIC” is selected:**
 Press <> to select “CNTR. IMAGE”, then press <> to set.
CNTR. IMAGE:
 The expansion of the center channel can be adjusted. (0.0 to 1.0, default : 0.3)
- 6 Press ENTER or SURROUND PARAMETER.**

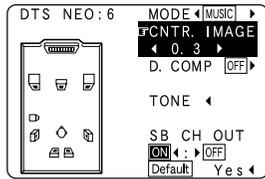
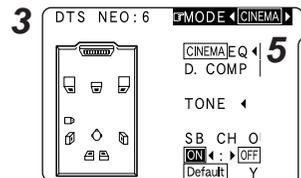

(When “MUSIC” is selected)

Checking the input signals

- 1 Press [ON SCREEN].**
Room EQ:
 Displays the type of equalizer currently set.
SIGNAL:
 Displays the type of input signal.
fs:
 Displays the input signal’s sampling frequency.
FORMAT:
 Displays the input signal’s number of channels (front / surround / LFE on/off).
 “SURROUND” is displayed for 2-channel signal sources recorded in Dolby Surround.
OFFSET:
 Displays the dialog normalization offset value.
FLAG:
 “MATRIX” is displayed if the input signal has undergone matrix processing, “DISCRETE” is displayed if the input signal has undergone discrete processing.
- 2 Press [ON SCREEN] again.**
 - **OSD-1** : Input signal
 - **OSD-2** : HDMI monitor information
 - **OSD-3** : Input/output settings
 - **OSD-4** : Auto surround mode
 - **OSD-5 ~ 7** : USER MODE 1 ~ 3
 - **OSD-8 ~ 14** : Tuner preset stations



Example: Dolby Digital



Example: DTS



- “OSD-1” “FLAG” is not displayed if there is no FLAG identification signal in the input signal.
- OSD-2:
 The monitor’s resolution is displayed when an HDMI monitor is connected to the AVR-987.
- OSD-4:
 This is displayed when the auto surround mode is set to “ON” (page 23) and the input mode is set to “AUTO”. It is not displayed when the input mode is set to “ANALOG” or “EXT. IN”.

Surround modes and parameters

Surround Mode	Signals and adjustability in the different modes																					
	Channel output					Parameter (default values are shown in parentheses)																
	FRONT L/R	CENTER	SURROUND L/R	SURROUND BACK L/R	SUB-WOOFER	D. COMP *1	LFE *2	AFDM *1	SB CH OUT	TONE CONTROL	CINEMA EQ.	MODE	ROOM SIZE	EFFECT LEVEL	Dolby Digital	DELAY TIME	SUBWOOFER ON/OFF	PRO LOGIC II/IIx MUSIC MODE only			NEO:6 MUSIC MODE only	EXT. IN only
															NIGHT mode			PANORAMA	DIMENSION	CENTER WIDTH	CENTER IMAGE	SW ATT
PURE DIRECT, DIRECT	○	×	×	×	⊙	○ (OFF)	○ (0 dB)	×	×	×	×	×	×	○ (OFF)	×	○	×	×	×	×	×	
MULTI CH DIRECT	○	⊙	⊙	⊙	⊙	×	○ (0 dB)	○ (ON)	○	×	×	×	×	×	×	×	×	×	×	×	×	
STEREO	○	×	×	×	⊙	○ (OFF)	○ (0 dB)	×	×	○ (0 dB)	×	×	×	○ (OFF)	×	×	×	×	×	×	×	
EXT. IN	○	⊙	⊙	⊙	⊙	×	×	×	×	×	×	×	×	×	×	×	×	×	×	×	○	
MULTI CH IN	○	⊙	⊙	⊙	⊙	×	○ (0 dB)	○ (ON)	○	○ (0 dB)	×	×	×	×	×	×	×	×	×	×	×	
WIDE SCREEN	○	⊙	⊙	⊙	⊙	○ (OFF)	○ (0 dB)	×	○	○ (0 dB)	○ (OFF)	×	×	○ (ON, 10)	○ (OFF)	×	×	×	×	×	×	
DOLBY PRO LOGIC IIx	○	⊙	⊙	⊙	⊙	○ (OFF)	×	×	○	○ (0 dB)	○ (NOTE3)	○ (CINEMA)	×	×	○ (OFF)	×	×	○ (OFF)	○ (3)	○ (3)	×	×
DOLBY PRO LOGIC II	○	⊙	⊙	×	⊙	○ (OFF)	×	×	○	○ (0 dB)	○ (NOTE4)	○ (CINEMA)	×	×	○ (OFF)	×	×	○ (OFF)	○ (3)	○ (3)	×	×
DTS NEO:6	○	⊙	⊙	⊙	⊙	○ (OFF)	×	×	○	○ (0 dB)	○ (NOTE3)	○ (CINEMA)	×	×	○ (OFF)	×	×	×	×	○ (0.3)	×	
DOLBY DIGITAL	○	⊙	⊙	⊙	⊙	○ (OFF)	○ (0 dB)	○ (ON)	○	○ (0 dB)	○ (OFF)	×	×	×	○ (OFF)	×	×	×	×	×	×	
DTS SURROUND	○	⊙	⊙	⊙	⊙	○ (OFF)	○ (0 dB)	○ (ON)	○	○ (0 dB)	○ (OFF)	×	×	×	×	×	×	×	×	×	×	
7CH STEREO	○	⊙	⊙	⊙	⊙	○ (OFF)	○ (0 dB)	×	○	○ (0 dB)	×	×	×	○ (OFF)	×	×	×	×	×	×	×	
SUPER STADIUM	○	⊙	⊙	⊙	⊙	○ (OFF)	○ (0 dB)	×	○	○ (NOTE1)	×	×	○ (Medium)	○ (10)	○ (OFF)	×	×	×	×	×	×	
ROCK ARENA	○	⊙	⊙	⊙	⊙	○ (OFF)	○ (0 dB)	×	○	○ (NOTE2)	×	×	○ (Medium)	○ (10)	○ (OFF)	×	×	×	×	×	×	
JAZZ CLUB	○	⊙	⊙	⊙	⊙	○ (OFF)	○ (0 dB)	×	○	○ (0 dB)	×	×	○ (Medium)	○ (10)	○ (OFF)	×	×	×	×	×	×	
CLASSIC CONCERT	○	⊙	⊙	⊙	⊙	○ (OFF)	○ (0 dB)	×	○	○ (0 dB)	×	×	○ (Medium)	○ (10)	○ (OFF)	×	×	×	×	×	×	
MONO MOVIE	○	⊙	⊙	⊙	⊙	○ (OFF)	○ (0 dB)	×	○	○ (0 dB)	×	×	○ (Medium)	○ (10)	○ (OFF)	×	×	×	×	×	×	
VIDEO GAME	○	⊙	⊙	⊙	⊙	○ (OFF)	○ (0 dB)	×	○	○ (0 dB)	×	×	○ (Medium)	○ (10)	○ (OFF)	×	×	×	×	×	×	
MATRIX	○	⊙	⊙	⊙	⊙	○ (OFF)	○ (0 dB)	×	○	○ (0 dB)	×	×	×	×	○ (OFF)	○ (30 msec)	×	×	×	×	×	×
VIRTUAL	○	×	×	×	⊙	○ (OFF)	○ (0 dB)	×	×	○ (0 dB)	×	×	×	×	○ (OFF)	×	×	×	×	×	×	×

○ : Signal
 × : No signal
 ⊙ : Turned on or off by speaker configuration setting

○ : Adjustable
 × : Not adjustable
 NOTE1 : BASS +6 dB, TREBLE 0 dB
 NOTE2 : BASS +6 dB, TREBLE +4 dB
 NOTE3 : This parameter is available when the "MODE" is set to "CINEMA".
 NOTE4 : This parameter is available when the "MODE" is set to "CINEMA" or "PL".
 *1: When playing Dolby Digital and DTS signals.
 *2: When playing Dolby Digital, DTS, DVD-Audio and Super Audio CD.

○ : Signal
 × : No signal

○ : Adjustable
 × : Not adjustable

■ Differences in surround mode names depending on the input signals

Button	Surround Mode	Note	Input signals													
			ANALOG	LINEAR PCM	DTS				DOLBY DIGITAL					DVD-AUDIO		
					DTS ES DSCRT (With Flag)	DTS ES MTRX (With Flag)	DTS (5.1ch)	DTS 96/24	DOLBY DIGITAL EX (With Flag)	DOLBY DIGITAL EX (With no Flag)	DOLBY DIGITAL (5.1ch)	DOLBY DIGITAL (3, 4, 5ch)	DOLBY DIGITAL (2ch)	DVD-Audio (multi ch)	DVD-Audio (2ch)	176.4/ 192kHz
STANDARD																
DTS SURROUND																
	DTS ES DSCRT6.1	*1	X	X	● ◎	X	X	X	X	X	X	X	X	X	X	X
	DTS ES MTRX6.1	*1	X	X	X	● ◎	X	X	X	X	X	X	X	X	X	X
	DTS SURROUND		X	X	○	○	●	X	X	X	X	X	X	X	X	X
	DTS 96/24		X	X	X	X	●	X	X	X	X	X	X	X	X	X
	DTS + PLIIx CINEMA	*2	X	X	○	○	○	○	X	X	X	X	X	X	X	X
	DTS + PLIIx MUSIC	*1	X	X	○	○	○	○	X	X	X	X	X	X	X	X
	DTS + NEO:6	*1	X	X	X	○	○	○	X	X	X	X	X	X	X	X
	DTS NEO:6 CINEMA		○	○	X	X	X	X	X	X	X	X	○	X	○	X
	DTS NEO:6 MUSIC		○	○	X	X	X	X	X	X	X	X	○	X	○	X
DOLBY SURROUND																
	DOLBY DIGITAL EX	*1	X	X	X	X	X	X	○	○	○	○	X	X	X	X
	DOLBY DIGITAL		X	X	X	X	X	X	○	●	●	●	X	X	X	X
	DOLBY DIGITAL+PL IIX CINEMA	*2	X	X	X	X	X	X	● ◎	○	○	○	X	X	X	X
	DOLBY DIGITAL+PL IIX MUSIC	*1	X	X	X	X	X	X	○	○	○	○	X	X	X	X
	DOLBY PRO LOGIC IIX CINEMA		○	○	X	X	X	X	X	X	X	X	●	X	○	X
	DOLBY PRO LOGIC IIX MUSIC		○	○	X	X	X	X	X	X	X	X	○	X	○	X
	DOLBY PRO LOGIC IIX GAME		○	○	X	X	X	X	X	X	X	X	○	X	○	X
	DOLBY PRO LOGIC II CINEMA		○	○	X	X	X	X	X	X	X	X	○	X	○	X
	DOLBY PRO LOGIC II MUSIC		○	○	X	X	X	X	X	X	X	X	○	X	○	X
	DOLBY PRO LOGIC II GAME		○	○	X	X	X	X	X	X	X	X	○	X	○	X
	DOLBY PRO LOGIC		○	○	X	X	X	X	X	X	X	X	○	X	○	X
MULTI CH IN																
	MULTI CH IN		X	X	X	X	X	X	X	X	X	X	X	●	X	X
	MULTI IN + PLIIx CINEMA	*2	X	X	X	X	X	X	X	X	X	X	X	○	X	X
	MULTI IN + PLIIx MUSIC	*1	X	X	X	X	X	X	X	X	X	X	X	○	X	X

- : Mode selectable in default status
- ◎ : Mode fixed when AFDM is "ON"
- : Selectable mode
- X : Non-selectable mode

NOTE :

*1: This mode is not available when the Surround Back speaker setup is set to "None".

*2: This mode is not available when the Surround Back speaker setup is set to "1spkr" or "None".

Button		Input signals														
Surround Mode	Note	ANALOG	LINEAR PCM	DTS				DOLBY DIGITAL					DVD-AUDIO			
				DTS ES DSCRT (With Flag)	DTS ES MTRX (With Flag)	DTS (5.1ch)	DTS 96/24	DOLBY DIGITAL EX (With Flag)	DOLBY DIGITAL EX (With no Flag)	DOLBY DIGITAL (5.1ch)	DOLBY DIGITAL (3, 4, 5ch)	DOLBY DIGITAL (2ch)	DVD-Audio (multi ch)	DVD-Audio (2ch)	176.4/192kHz	
DIRECT																
DIRECT		○	○	○	○	○	○	○	○	○	○	○	○	○	○	○
MULTI CH DIRECT		×	×	×	×	×	×	×	×	×	×	×	×	×	×	×
M DIRECT + PLIIx CINEMA	*2	×	×	×	×	×	×	×	×	×	×	×	×	×	×	×
M DIRECT + PLIIx MUSIC	*1	×	×	×	×	×	×	×	×	×	×	×	×	×	×	×
PURE DIRECT																
PURE DIRECT		○	○	○	○	○	○	○	○	○	○	○	○	○	○	○
MULTI CH PURE DIRECT		×	×	×	×	×	×	×	×	×	×	×	×	×	×	×
M PURE D + PLIIx CINEMA	*2	×	×	×	×	×	×	×	×	×	×	×	×	×	×	×
M PURE D + PLIIx MUSIC	*1	×	×	×	×	×	×	×	×	×	×	×	×	×	×	×
DSP SIMULATION																
7CH STEREO	*3	○	○	○	○	○	○	○	○	○	○	○	○	○	○	○
WIDE SCREEN		○	○	○	○	○	○	○	○	○	○	○	○	○	○	○
SUPER STADIUM		○	○	○	○	○	○	○	○	○	○	○	○	○	○	○
ROCK ARENA		○	○	○	○	○	○	○	○	○	○	○	○	○	○	○
JAZZ CLUB		○	○	○	○	○	○	○	○	○	○	○	○	○	○	○
CLASSIC CONCERT		○	○	○	○	○	○	○	○	○	○	○	○	○	○	○
MONO MOVIE		○	○	○	○	○	○	○	○	○	○	○	○	○	○	○
VIDEO GAME		○	○	○	○	○	○	○	○	○	○	○	○	○	○	○
MATRIX		○	○	○	○	○	○	○	○	○	○	○	○	○	○	○
VIRTUAL		○	○	○	○	○	○	○	○	○	○	○	○	○	○	○
STEREO																
STEREO		●	●	○	○	○	○	○	○	○	○	○	○	○	○	○

- : Mode selectable in default status
- : Selectable mode
- ×

NOTE :

- *1: This mode is not available when the Surround Back speaker setup is set to "None".
- *2: This mode is not available when the Surround Back speaker setup is set to "1spkr" or "None".
- *3: If the Surround Back speaker setup is set to "None", then "5CH STEREO" is displayed.

Using the DENON original surround modes

The AVR-987 is equipped with a high performance digital signal processor (DSP) that uses digital signal processing to recreate sound fields artificially. One of 10 surround modes can be selected according to the program source and parameters can be further adjusted to achieve even more realistic sound fields.

Types of surround modes and their features

7CH STEREO (NOTE 1)	This mode lets you enjoy stereo sound with 7 speakers. The front L (R) channel signals are played from the surround and surround back L (R) channels and only the in-phase component of the L and R channels is played on the center channel.
WIDE SCREEN	This mode recreates the atmosphere of watching a movie in a theater with a large screen. In this mode, all sources are played in the 7.1-channel mode.
SUPER STADIUM	This mode recreates the atmosphere of watching a game of baseball, soccer or other sport in a stadium.
ROCK ARENA	This mode recreates the atmosphere of a live concert in an arena.
JAZZ CLUB	This mode recreates the atmosphere of a live concert in a club with low ceilings, hard walls and the artist just in front of you.
CLASSIC CONCERT	This mode recreates the atmosphere of a concert hall with rich reverberations.
MONO MOVIE (NOTE 2)	This mode recreates the atmosphere of an expansive sound field for movie sources recorded in monaural.
VIDEO GAME	This mode provides a rich sense of presence for video games.
MATRIX	This mode recreates music sources recorded in stereo with an enhanced sense of expansion.
VIRTUAL	This mode can be used to enjoy surround sound with only front speakers or when using headphones.

NOTE 1: "5CH STEREO" is displayed when "SB CH OUT" is set to "OFF".

NOTE 2: When playing sources recorded in monaural, the sound will be one-sided if signals are only input to one channel (left or right), so input signals to both channels. If you have a source component with only one audio output (monophonic camcorder, etc.) obtain a "Y" adapter cable to split the mono output to two outputs, and connect to the L and R inputs.



- Depending on the program source being played, the effect may not be very noticeable. In this case, try other surround modes, without worrying about their names, to create a sound field suited to your tastes.

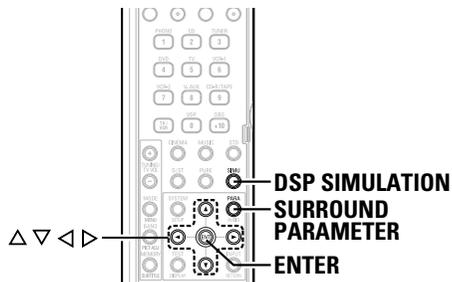
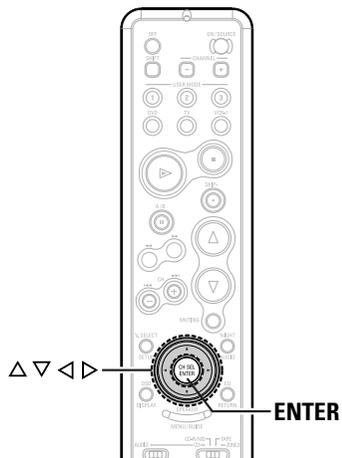
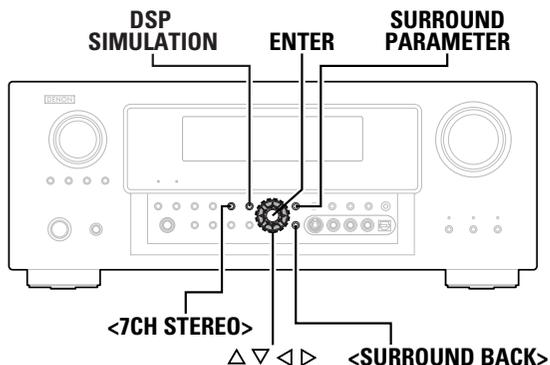

About the button names in this explanation
 < > : Buttons on the main unit
 [] : Buttons on the remote control unit
Button name only :
 Buttons on the main unit and remote control unit

Selecting the DSP surround simulation

1 Press [DSP SIMULATION].

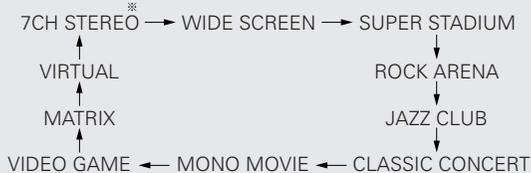

* The 7CH STEREO mode can be selected directly by pressing <7CH STEREO>.

2 Press SURROUND PARAMETER.



3 Press Δ ∇ to select the item, then press ◀ ▶ to set.

EFFECT: (WIDE SCREEN mode only)
 Effect signals with the multi-surround speaker effects are played. When set to "OFF", the SL/ SR channels are played from the SBL/ SBR channels, respectively.

LEVEL: (WIDE SCREEN mode only)
 Adjust the strength of effect signals "1" to "15".

SB CH OUT
 • **ON:**
 Surround back channel played.
 • **OFF:**
 Surround back channel not played.
 * This operation can also be performed using <SURROUND BACK>.

ROOM SIZE:
 Adjust the imaginary size of the recreated sound field space. (Does not express size of room in which played.)
 There are 5 parameters: "small", "med.s", "medium", "med.l" and "large".

EFFECT LEVEL:
 Adjust the strength of the surround effect.

DELAY TIME: (MATRIX mode only)
 Adjust the delay time between "0 ms" and "300 ms".

4 Press ENTER or SURROUND PARAMETER.



- Select "Default Yes" and press ◀ to reset all the settings.

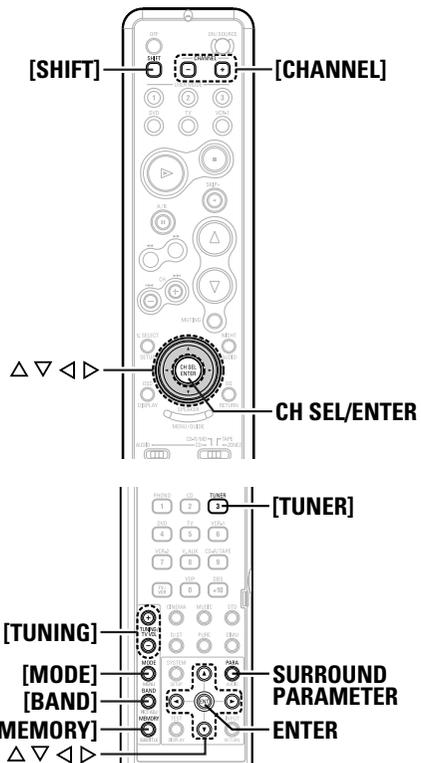
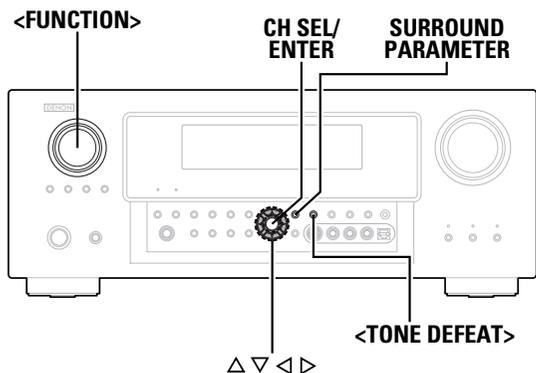

Setting the tone control

Adjust the bass and treble to suit your tastes.

■ Adjusting the tone

- 1 Press **SURROUND PARAMETER**.
- 2 Press Δ ∇ to select "TONE", then press \triangleleft .
 ※ In the direct mode, "TONE" cannot be selected.
- 3 Press \triangleright to select "OFF".
- 4 Press Δ ∇ to select "Bass" or "Treble", then press \triangleleft \triangleright to set the level.
 ※ Can be adjusted within the range of -6 dB to +6 dB.
- 5 Press **ENTER**.
- 6 Press **ENTER** or **SURROUND PARAMETER**.

- 1
 - 2
 - 3

■ When you do not want to adjust the tone

Either press **<TONE DEFEAT>** or set "Tone Defeat" to "ON" at step 3 in "Adjusting the tone".

Adjusting the speaker volume

- 1 Press **CH SEL/ENTER**.

"SB" when surround back speaker set to "1spkr".
Not displayed when "None" set.
- 2 Press Δ ∇ or **CH SEL/ENTER** to select the speaker.
 ※ The settable speaker switches each time this button is pressed.
- 3 Press \triangleleft \triangleright to adjust the volume.
 ※ Can be adjusted within the range of -12 dB to +12 dB.

About the button names in this explanation
 \triangleleft \triangleright : Buttons on the main unit
 [] : Buttons on the remote control unit
Button name only :
 Buttons on the main unit and remote control unit

Using the fader function

With this function, the volume of all the front side speakers or all the rear side speakers can be adjusted (attenuated) at once.

1 Press **CH SEL/ENTER**.

2 Press \triangle ∇ or **CH SEL/ENTER** to select “Fader”.

3 Press \triangleleft to attenuate the volume of all the front side speakers, \triangleright to attenuate the volume of all the rear side speakers.

- ※ The fader function does not affect the subwoofer.
- ※ It is possible to adjust so that the volume of the speaker whose volume is the lowest is -12 dB.

2

Channel Vol.			
FL	0.0dB	SR	0.0dB
C	0.0dB	SBR	0.0dB
FR	0.0dB	SBL	0.0dB
SW	0.0dB	SL	0.0dB

Fader
FRONT \triangleleft : \triangleright REAR

3

Channel Vol.			
FL	-0.5dB	SR	0.0dB
C	-0.5dB	SBR	0.0dB
FR	-0.5dB	SBL	0.0dB
SW	0.0dB	SL	0.0dB

Fader
FRONT \triangleleft : \triangleright REAR

Listening to the radio

Check that the remote control unit is set to “AMP”.

Auto tuning

1 Either turn **<FUNCTION>** or press **[TUNER]** to select “TUNER”.

2 Press **[BAND]** to select “AM”, “FM” or “XM”.

※ When listening to the XM Satellite Radio (☞ page 36, 37).

3 Press **[MODE]** to set the auto tuning mode.

- The “AUTO” indicator lights.

4 Press **[TUNING]**.

- Automatic searching begins.



- If tuning does not stop at the desired station, use to the “Manual tuning” operation.

Manual tuning

1 Either turn **<FUNCTION>** or press **[TUNER]** to select “TUNER”.

2 Press **[BAND]** to select “AM”, “FM” or “XM”.

※ When listening to the XM Satellite Radio (☞ page 36, 37).

3 Press **[MODE]** to set the manual tuning mode.

※ Check that the display’s “AUTO” indicator turns off.

4 Press **[TUNING]** to tune in the desired station.

※ The frequency changes continuously when the button is held in.



- When the manual tuning mode is set, FM stereo broadcasts are received in monaural and the “STEREO” indicator turns off.

Preset memory

1 Use the “Auto tuning” or “Manual tuning” operation to tune in the station to be preset in the memory.

2 Press **[MEMORY]**.

3 Press **[SHIFT]** to select the desired memory block (A to G).

4 Press **[CHANNEL]** to select the desired preset channel (1 to 8).

5 Press **[MEMORY]** again.

- Store the station in the preset memory.



- To preset other channels, repeat steps 2 to 5. A total of 56 broadcast stations can be preset — 8 stations (channels 1 to 8) in each of blocks A to G.
- The memory block can also be selected by pressing **[SHIFT]**.

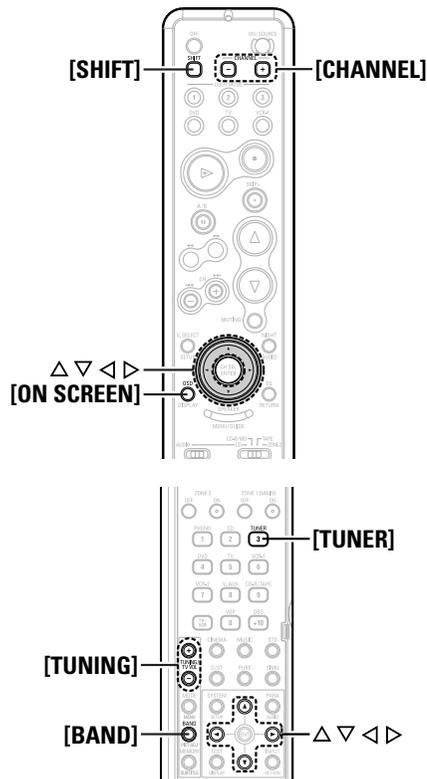
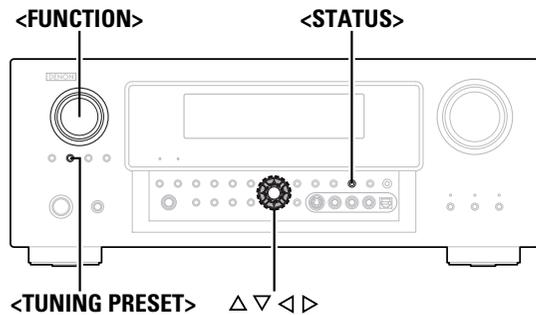

About the button names in this explanation
 < > : Buttons on the main unit
 [] : Buttons on the remote control unit
Button name only :
 Buttons on the main unit and remote control unit

Checking the preset stations

Press [ON SCREEN] repeatedly until the “Tuner Preset Stations” screen appears on the OSD.

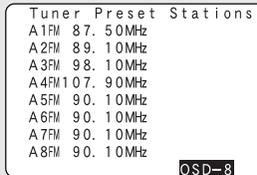

Recalling preset stations

■ Main unit

1 Press <TUNING PRESET>.

2 Turn <FUNCTION> and select the desired preset channel.

■ Remote control unit

1 Press [SHIFT] to select the memory block.

2 Press [CHANNEL] to select the desired preset channel.

XM Satellite Radio

AVR-987 is the XM Ready® receiver. You can receive XM Satellite Radio® by connecting to the XM Connect-and-Play™ (sold separately) and subscribing the XM service.

■ Introducing XM Satellite Radio

There's a world of audio listening pleasure beyond AM and FM. XM Satellite Radio. Select from over 150 channels of music, news, sports, comedy, talk, and entertainment. Coast-to-coast coverage. Digital quality sound. With all music channels 100% commercial free.

Questions?: Visit www.xmradio.com.

■ How to Subscribe

Listeners can subscribe by visiting XM on the Web at www.xmradio.com or by calling XM's Listener Care at (800) 967-2346.

Customers should have their Radio ID and credit card ready. The Radio ID can be found by selecting channel 0 on the radio.

■ A Warning Against Reverse Engineering

It is prohibited to copy, decompile, disassemble, reverse engineer, or manipulate any technology incorporated in receivers compatible with the XM Satellite Radio system.

Furthermore, the AMBE® voice compression software included in this product is protected by intellectual property rights including patent rights, copyrights, and trade secrets of Digital Voice Systems, Inc. The user of this or any other software contained in an XM Radio is explicitly prohibited from attempting to copy, decompile, reverse engineer, or disassemble the object code, or in any other way convert the object code into human-readable form. The software is licensed solely for use within this product.

Hardware and required basic monthly subscription sold separately. Premium Channel available at additional monthly cost.

Installation costs and other fees and taxes, including a one-time activation fee may apply. Subscription fee is consumer only.

All fees and programming subject to change. Subscriptions subject to Customer Agreement available at xmradio.com. Only available in the 48 contiguous United States. ©2005 XM Satellite Radio Inc. All rights reserved. All other trademarks are the property of their respective owners.

Checking the XM signal strength and Radio ID

1 Either turn <FUNCTION> or press [TUNER] to select “TUNER”.

2 Press [BAND] to select “XM”.

3 Press <STATUS> until “SIGNAL” is displayed.
 • The display changes as shown below according to the receiving condition.

Display	Condition
GOOD	Signal strength is good
MARGINAL	Signal strength is marginal
WEAK	Signal strength is poor
NO	Loss of the signal

4 Adjust the antenna location until “SIGNAL:GOOD” is displayed.

5 Press <STATUS> until the XM channel (ex.XM001) is displayed.

6 Press [TUNING -] to select channel 0 (XM000).



Channel selection

1 Either turn <FUNCTION> or press [TUNER] to select “TUNER”.

2 Press [BAND] to select “XM”.

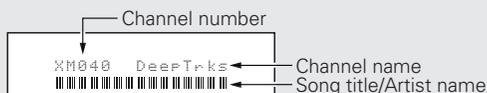

3 Press [TUNING] to reach the desired channel.

- ※ The channel changes continuously when you press and hold [TUNING].
- ※ When the artist name and song title are received, they are displayed.

Category search

1 Press ◀▶ in the XM mode.
 • The current category name is displayed.

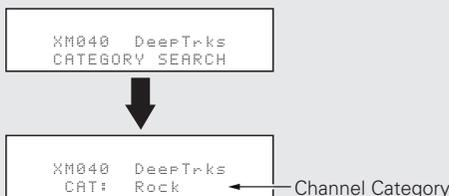

2 Press ◀▶ to select the category, and press ▲▼ to select the channel within the selected category.



- “LOADING” is displayed while receiving the channel or information.
- “UPDATING” is displayed while updating encryption code.
- When the selected channel is not available, “XM- -” is displayed.
- Information on the artist name, song title, category and signal level can be checked using <STATUS>.
- The XM Satellite Radio channels can be preset in the same way as AM/FM band (☞ page 35).

Advanced Operation

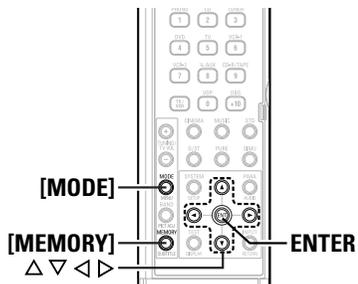
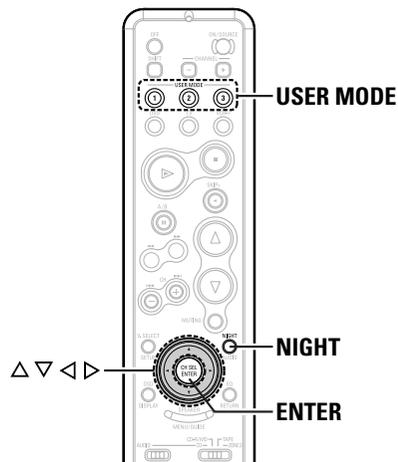
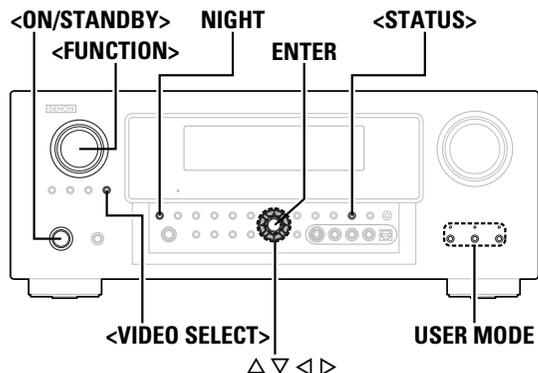

About the button names in this explanation

< > : Buttons on the main unit
 [] : Buttons on the remote control unit

Button name only :

Buttons on the main unit and remote control unit

Advanced Operation

Night mode

The night mode can be set when playing Dolby Digital sources. The dialogues are easier to hear at night and when listening with the volume low.

Press **NIGHT**.

- The "NIGHT" indicator lights.



- Canceling night mode:
Press **NIGHT** again.
- When the night mode is set to "ON", the "D.COMP" surround parameter can not be selected.

User mode function

The AVR-987 is equipped with a function for storing the selected input source, the auto surround mode and input mode in the memory and selecting these settings when you want to use them.

■ Storing the settings in the memory

1 The following are stored in the memory:

- ① Currently set input source
- ② Currently set surround mode
- ③ Currently set input mode

2 Press and hold **USER MODE**.

- ※ Press and hold in until the selected user mode indicator lights.

■ Calling the settings out

Press **USER MODE** at which the settings you want to call out are stored.

- The selected user mode display lights.

Combining the currently playing sound with the desired image (VIDEO SELECT function)

Press **<VIDEO SELECT>**, turn **<FUNCTION>** until the desired image appears on the display.



- To cancel, press **<VIDEO SELECT>** and turn **<FUNCTION>** to select "SOURCE".
- The video source selected with the video select function is stored in the memory for the different input sources.
- It is not possible to select HDMI input signals.
- When playing HDMI video input signals, the analog video signal of another function cannot be selected for the HDMI video output.

Personal memory plus function

The surround mode last selected and the input mode setting are stored individually for the different input sources.

- ※ The surround parameters, tone control settings and playback level balance for the different output channels are memorized for each surround mode.

Playing the iPod®

The music recorded on the iPod can be played when using a DENON original Control Dock for iPod (ASD-1R). The iPod can be controlled using the buttons on the main unit and the remote control unit.



iPod is a trademark of Apple Computer, Inc., registered in the U.S. and other countries.

※ With the iPod, non-copyrighted contents and contents that may be legally reproduced or played may be reproduced and played by individuals for their personal use. Violating copyrights is prohibited by law.

1 Connect the AVR-987 and iPod using the DENON original Control Dock for iPod (☞ page 21).

2 Assign the input terminal at “Setting the iPod Assignment” (☞ page 47).

3 Use **FUNCTION** to select the function assigned in step 2.

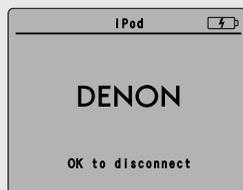

(iPod screen)

※ If the screens above are not displayed, the iPod may not be properly connected. Check the connections and settings.



• The optional standard Control Dock for iPod is DENON ASD-1R sold separately.

NOTE:

- DENON will accept no responsibility whatsoever for loss or damage of data on an iPod occurring when the iPod is used connected to the AVR-987.
- Some of the functions may not operate, depending on the type of iPod and the software version.

Listening to music

1 Press Δ ∇ to select the music file, then press **ENTER** or \triangleright .

※ Press \triangleleft to return to the music menu screen.

2 Press **ENTER** or \triangleright .
• Playback starts.

Pause:

Press **ENTER** during playback.
Press again to resume.

Manual search:

Press and hold in Δ ∇ during playback.

- Δ : Fast reverse
- ∇ : Fast forward

Track search:

Press Δ ∇ during playback.

- Δ : Move to beginning of previous track
- ∇ : Move to beginning of next track

Stop:

Press **ENTER** for at least 2 seconds during playback.

Repeat play:

Press **[MODE]**.

The mode switches as follows each time **[MODE]** is pressed.

- **RPT One** : Single track repeat
- **RPT All** : All track repeat

Shuffle play:

Press **[MEMORY]**.

The mode switches as follows each time **[MEMORY]** is pressed.

- **SFL Songs** : Single track shuffle
- **SFL Albums** : Album shuffle

※ The mode switches between the Browse mode and the Remote mode if **[MODE]** is pressed for at least 2 seconds. In the Remote mode, only Δ ∇ \triangleleft and **ENTER** can be used.



- When **<STATUS>** is pressed during playback, the front panel display switches between the title name, artist name and album name.
- Depending on the iPod's software version, it may not be possible to operate the iPod from the AVR-987. Use the latest version of the software. Information on the latest version of the software can be obtained on the Apple Computer website.
- If you do not want the on screen display to be displayed while playing the iPod, set “Function/Mode Status” at “Setting the On Screen Display” to “OFF” (☞ page 52).
- With the AVR-987 it is possible to display folder names and file names on the screen like titles. The AVR-987 can display up to 64 characters, consisting of numbers, capital letters and small letters. A “?” mark is displayed in place of non-compatible characters.

Viewing still pictures and videos (only for iPods equipped with the slideshow / video function)

Use this procedure to view photo and video data stored on the iPod on a monitor.

1 Press **[MODE]** for at least 2 seconds to switch from the Browse mode to the Remote mode.

- “Remote iPod” is displayed on the AVR-987's display.

2 Watching the iPod's screen, press Δ ∇ to select “Photos” or “Video”, then press **ENTER** or \triangleright .

- The iPod's photo and video data are displayed on the monitor.



- To output photo or video data recorded on the iPod to the monitor, the iPod's “TV Out” setting (under “Video Settings”) must be set to “ON”.

For details, refer to the iPod's operating instructions.

Disconnecting the iPod

Press **<ON/STANDBY>** and set the AVR-987's power to the standby mode.

- ※ The iPod can be disconnected after switching to a function other than the one to which the iPod input is assigned.

Multi zone music entertainment system

- When the outputs of the ZONE2 output terminals are wired and connected to power amplifiers installed in other rooms, different sources can be played in rooms other than the MAIN ZONE in which this unit and the playback devices are installed. (Refer to ZONE2 on the diagram below.)
 - Settings can be made at "Power Amp Assign" in the "System Setup Menu" so that the same source as the ZONE2 output terminals can be played from the speakers connected to the ZONE2 speaker terminals (page 22).
 - When a sold separately room-to-room remote control unit (DENON RC-616, 617 or 618) is wired and connected between the MAIN ZONE and ZONE2, the remote-controllable devices in the MAIN ZONE can be controlled from ZONE2 using the remote control unit.
- ※ To control playback devices other than the ones above, either use that device's remote control unit or preset a separately sold programmable remote control unit.



- For instructions on installation and operation of separately sold devices, refer to the devices' operating instructions.

Multi-zone playback using the ZONE2 output terminals

■ When using the power amplifier as the MAIN ZONE output

The AVR-987 is equipped with ZONE2 output terminals for which the volume is fixed output level and composite video output terminals as the ZONE2 output terminals.

[System configuration and connections example]

- Using this AVR-987 external amplifier as the ZONE2.

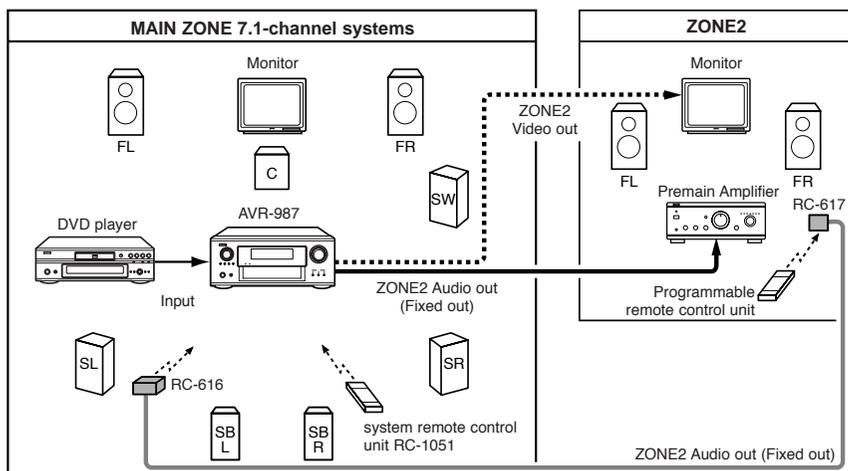

Multi-zone playback using the SPEAKER terminals

■ When using the SURROUND BACK amplifier as the ZONE2 output

When the surround back's power amplifier is assigned to the ZONE2 output channel at "Power Amp Assign" in the "System Setup Menu", the surround back speaker terminals can be used as the ZONE2 speaker out terminals (page 54).

[System configuration and connections example]

- Using this AVR-987 internal amplifier as the ZONE2.

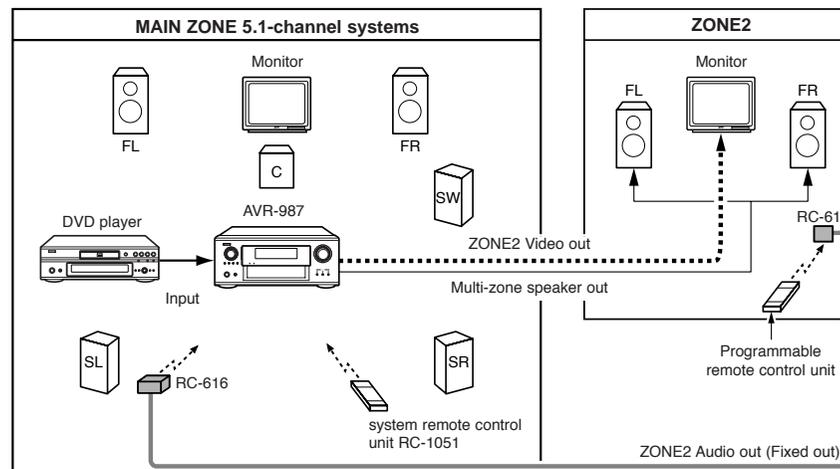

- : Multi source video signal cable
- : Multi source audio signal cable
- : Room-to room remote control system (separately sold) control line
- : Speaker cable

※ Refer to "Connections" (page 21, 22).

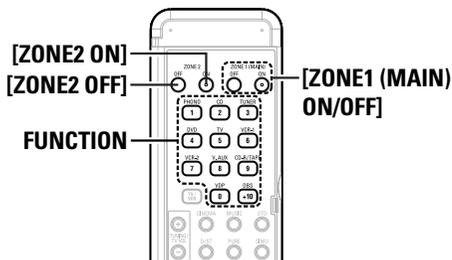
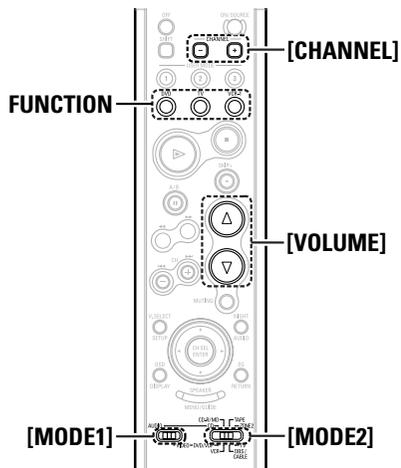
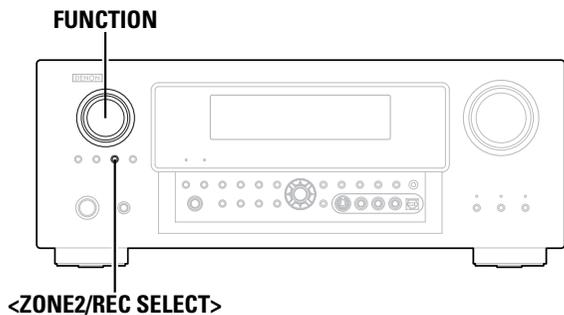

About the button names in this explanation
 < > : Buttons on the main unit
 [] : Buttons on the remote control unit
Button name only :
 Buttons on the main unit and remote control unit

Outputting a program source to amplifier, etc., in the ZONE2 room (ZONE2 SELECT mode)

- 1** Press <ZONE2/REC SELECT> to display the “ZONE2 SOURCE” on the display.
 - The “MULTI” indicator lights.

ZONE2 ← → RECOUT
- 2** With “ZONE2 SOURCE” displayed, turn <FUNCTION> to select the source you want to output appears on the display.
- 3** Start playing the source to be output.
 - ※ For operating instructions, refer to the manuals of the respective components.



- The signals of the source selected in the ZONE2 mode are also output from the VCR-1, VCR-2 and CD-R/TAPE recording output terminals.
- Digital signals are not output from the ZONE2 audio output terminals.
- About the MULTI ZONE connections (☞ page 40).

Remote control unit operations during multi-source playback

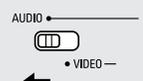
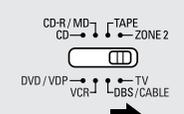
- 1** Set [MODE1] to “AUDIO”.
 
- 2** Set [MODE2] to “ZONE2”.
 
- 3** Press [ZONE2 ON] to turn on the zone power.
 - ※ Press [ZONE2 OFF] to turn off the zone power.
- 4** Select the input source you wish to output.
 - ※ When the function is set to TUNER, the preset channel can be selected using [CHANNEL].
- 5** The volume of the outputs of the different zones can be adjusted with [VOLUME].
 - ※ The ZONE2 volume can be adjusted only when “ZONE2” is selected at “Power Amp Assign” in the “System Setup Menu” (☞ page 54).
 - ※ Default volume setting:
 ZONE2 : -40 dB
 - ※ The zone volume can be adjusted within the range of -70 to 18 dB.



- When using ZONE2, it is possible to turn the power for the MAIN ZONE (main zone) only on or off by pressing [ZONE1 (MAIN) ON/OFF].

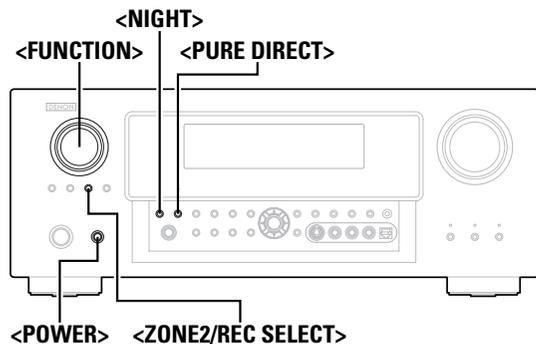

About the button names in this explanation

- < > : Buttons on the main unit
 [] : Buttons on the remote control unit

Button name only :

Buttons on the main unit and remote control unit

Recording (audio and/or video)

- 1 Press <ZONE2/REC SELECT> until "RECOUT" appears on the display.

ZONE2 ← → RECOUT

- 2 Use <FUNCTION> to select the source to be recorded (audio and/or video).

- The " REC " indicator lights.

- 3 Record (the audio or video signals).

※ For operations, see the operating instructions of the device from which you are recording (audio or video signals).



- To cancel, press <ZONE2/REC SELECT> and set the function to "ZONE2".

NOTE:

- When the REC OUT mode is selected, [ZONE2] and [FUNCTION] (ZONE2) cannot be operated.
- Digital signals are not output from the analog REC OUT, OPTICAL 3 OUT and OPTICAL 4 OUT terminals.

About the memory functions

■ Last function memory

The various settings set when the AVR-987's power is switched to standby are stored in the memory. When the power is turned back on, the settings made when the power was switched to standby are recalled.

■ Backup memory

The various settings are stored in the memory for about 1 week, even when the power is turned off or the power cord is unplugged.

Initialization of the microprocessor

Use the procedure described below to reset the microprocessor if the display is abnormal or if the buttons on the main unit or the remote control unit do not operate.

- 1 Switch off the unit using <POWER>.

- 2 Hold the following <PURE DIRECT> and <NIGHT>, and press <POWER>.

- 3 Check that the entire display is blinking with an interval of about 1 second, and release your fingers from the 2 buttons.

- The microprocessor will be initialized.



- If step 3 does not work, start over from step 1.
- If the microprocessor has been reset, all the settings are reset to the default values.

Advanced Setup – Part 1

System setup items and default values

1. Auto Setup/Room EQ

- 1. Auto Setup/Room EQ
- ▣ 1. Auto Setup
- 2. Room EQ Setup
- 3. Direct Mode Setup
- 4. Mic Input Select
- 5. Parameter Check
- Exit

Items		Default settings	Page
1	Auto Setup	-	9 ~ 12
2	Room EQ Setup	All, Room EQ = OFF	60
3	Direct Mode Setup	OFF	60
4	Mic Input Select	Mic	61

2. Speaker Setup

- 2. Speaker Setup
- ▣ 1. Speaker Config.
- 2. Subwoofer Setup
- 3. Distance
- 4. Channel Level
- 5. Crossover Frequency
- Exit

Items		Default settings					Page
1	Speaker Config.	Front Sp.	Center Sp.	Subwoofer	Surround Sp.	Surround Back Sp.	56, 57
		Large	Small	Yes	Small	Small / 2spkrs	
2	Subwoofer Setup	LFE					57
3	Distance	Front L & R	Center	Subwoofer	Surround L & R	Surround Back	57, 58
		12 ft (3.6 m)	12 ft (3.6 m)	12 ft (3.6 m)	10 ft (3.0 m)	10 ft (3.0 m)	
4	Channel Level	Front L	Front R	Center	Surround L	Surround R	58, 59
		0 dB	0 dB	0 dB	0 dB	0 dB	
5	Crossover Frequency	80 Hz					59

3. Audio Input Setup

3. Audio Input Setup
- 1. Digital In Assign
 - 2. EXT. IN Subwoofer Level
 - 3. iPod Assign
 - 4. Input Function Lev.
 - 5. Function Rename
 - 6. Tuner Presets
- Exit

Items		Default settings											Page
1	Digital In Assign This assigns the digital input terminals for the different input sources.	Input source		CD	DVD	VDP	TV	DBS	VCR-1	VCR-2	CD-R / TAPE	V.AUX	47
		Digital Inputs		COAX 1	COAX 2	OPT 1	OFF	OPT 2	OPT 3	OFF	OPT 4	OPT 5	
2	EXT. IN Subwoofer Level Sets the playback level of the analog signal that was input to the EXT. IN subwoofer terminal.	SW Level = +15 dB											47
3	iPod Assign It is possible to assign the DENON original Dock's audio and/or video signals to any input terminals on the AVR-987 and play them.	iPod Function = OFF											47
4	Input Function Lev. The playback level is corrected individually for the different input sources.	TUNER	PHONO	CD	CD-R / TAPE	DVD	VDP	TV	DBS	VCR-1	VCR-2	V.AUX	48
		0 dB	0 dB	0 dB	0 dB	0 dB	0 dB	0 dB	0 dB	0 dB	0 dB	0 dB	
5	Function Rename The name of the input function that is displayed can be changed.	TUNER	PHONO	CD	CD-R / TAPE	DVD	VDP	TV	DBS	VCR-1	VCR-2	V.AUX	48
6	Tuner Presets Up to 56 FM stations can be preset automatically.	Auto Preset Memory		A1 ~ A8	87.5/89.1/98.1/107.9/90.1/90.1/90.1/90.1 MHz								48
				B1 ~ B8	520/600/1000/1400/1500/1710 kHz, 90.1/90.1 MHz								
				C1 ~ C8	90.1 MHz								
				D1 ~ D8	90.1 MHz								
				E1 ~ E8	90.1 MHz								
				F1 ~ F8	90.1 MHz								
	G1 ~ G8			90.1 MHz									
	Preset channels that are not used often can be skipped.	Preset Skip		All preset channels = ON								49	
	The preset channels can be given the names you want.			Preset Name		-							

4. Video Setup

4. Video Setup
- 1. HDMI In Assign
 - 2. Component In Assign
 - 3. Video Convert
 - 4. HDMI Out Setup
 - 5. Audio Delay
 - 6. On Screen Display
- Exit

Items		Default settings							Page
1	HDMI In Assign The HDMI input terminals are assigned for the different input sources. Select the HDMI audio signal playback method.	DVD	VDP	TV	DBS	VCR-1	VCR-2	V.AUX	49, 50
		NONE	NONE	NONE	NONE	NONE	NONE	NONE	
2	Component In Assign This assigns the component video input terminals for the different input sources.	DVD	VDP	TV	DBS	VCR-1	VCR-2	V.AUX	50
		1-RCA	NONE	2-RCA	3-RCA	NONE	NONE	NONE	
3	Video Convert This sets whether or not to use the video conversion function.	ON							50
4	HDMI Out Setup Set whether or not to up-convert from analog video signals to HDMI. When this function is used, the format of the signal output from the HDMI terminal can be set.	Convert = ON i/p Convert = ON Color Space = Y Cb Cr RGB Mode = Normal							51
5	Audio Delay Adjust the time delay between the video and audio signals.	0 ms							51
6	On Screen Display Set whether or not to display the on screen display for indications other than the menu screens.	Function/Mode = ON Master Volume = ON Mode = Mode 1							52

5. Advanced Playback

- 5. Advanced Playback
- 1. 2ch Direct/Stereo
- 2. Dolby Digital Setup
- 3. Auto Surround Mode
- 4. Manual EQ Setup
- Exit

Items		Default settings	Page
1	2ch Direct/Stereo Make the 2-channel direct mode and stereo mode speaker settings.	Basic	52
2	Dolby Digital Setup Turn the audio compression on or off when down-mixing Dolby Digital signals.	OFF	53
3	Auto Surround Mode Set whether or not to store the surround mode last played for the input signal.	Auto Surround Mode = ON	53
4	Manual EQ Setup Adjust the tone of the various speakers while listening to the playback signals.	All Channels and Frequency = 0 dB	53, 54

6. Option Setup

- 6. Option Setup
- 1. Power Amp Assign
- 2. Volume Control
- 3. Trigger Out
- 4. Setup Lock
- Exit

Items		Default settings	Page
1	Power Amp Assign To suit your preference, a surround back channel's power amplifier can be assigned to the front channel ("Front A" or "Front B") for bi-amp playback, ZONE2.	S. Back	54
2	Volume Control This sets the volume level of output.	Vol.Limit = OFF P. On Lev. = LAST Mute Lev. = FULL ZONE = MAIN, All Surround Modes = ON	55
3	Trigger Out Use the DC12V output of the AVR-987's two trigger out jacks in association with the various input sources and surround modes.	Trigger Out 1	55
		Trigger Out 2	
4	Setup Lock This sets whether or not to lock the system setup settings so that they cannot be changed.	Setup Lock = OFF	56

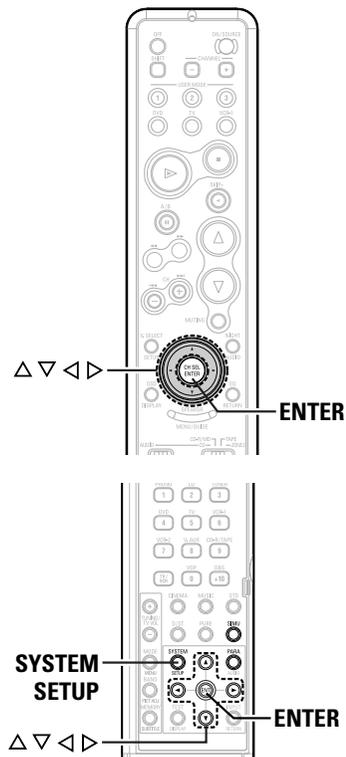
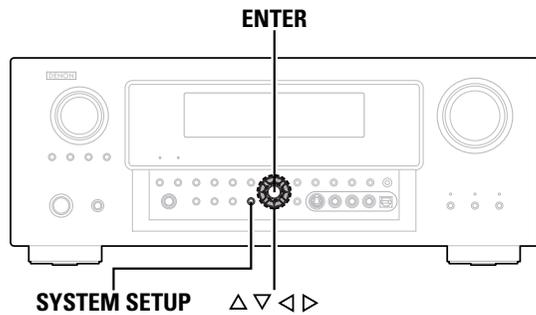

Navigating through the System Setup Menu

- 1** Press **SYSTEM SETUP**.
 - The “System Setup Menu” appears.
- 2** Press Δ ▽ to select the item you want to set, then press **ENTER**.
- 3** Press Δ ▽ again to select the item you want to set, then press **ENTER**.
- 4** To change the setting:
 - Press Δ ▽ to select the item you want to change, then press ◀ ▶ to change the setting.
 - ※ Select “Default Yes”, then press ◀ to reset to the default setting.
- 5** Press **ENTER** and set a new item.
- 6** Press **SYSTEM SETUP** to return to the “System Setup Menu” or the main menu.

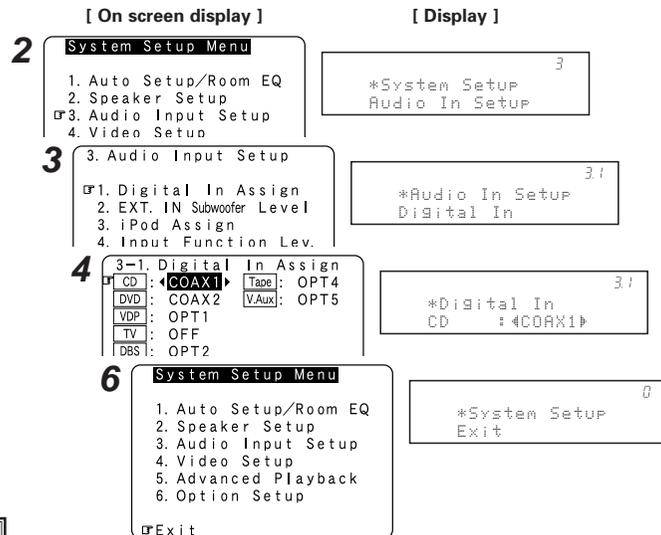

About the display

In addition to the easily understandable on screen display, the AVR-987 is also equipped with displays for checking the settings. Use this when making settings and operating. Below are some examples of typical displays.

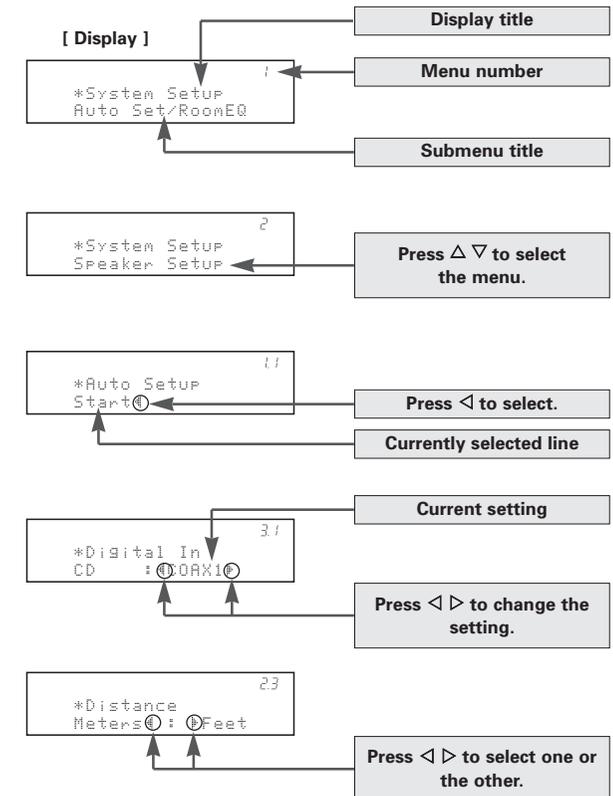

About the button names in this explanation

< > : Buttons on the main unit
[] : Buttons on the remote control unit

Button name only :

Buttons on the main unit and remote control unit

Audio Input Setup

Setting the Digital In Assignment

This assigns the digital input terminals for the different input sources.

1 Press Δ ∇ to select “Audio Input Setup”, then press **ENTER**.

2 Press Δ ∇ to select “Digital In Assign”, then press **ENTER**.

3 Press Δ ∇ to select the input source, then press \triangleleft \triangleright to set.

COAX1, COAX2, OPT1, OPT2, OPT3, OPT4, OPT5:

Assign the different terminals according to the devices connected to the AVR-987’s input terminals.

※ The HDMI input terminal is displayed when it is assigned to the input source at “HDMI In Assign” (page 49, 50).

4 Press **ENTER**.

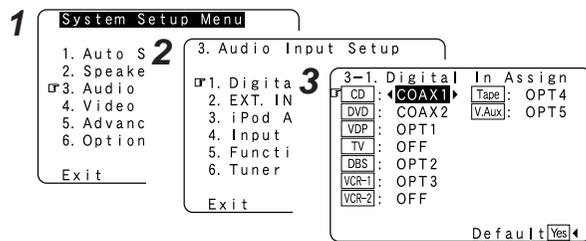

- “PHONO” and “TUNER” cannot be selected on the “Digital In Assign” screen.
- It is not possible to make the “Digital In Assign” settings for the function assigned at “iPod Assign”.

Setting the EXT. IN Subwoofer Level

Sets the playback level of the analog signal that was input to the EXT. IN subwoofer terminal.

1 Press Δ ∇ to select “EXT. IN Subwoofer Level”, then press **ENTER**.

2 Press \triangleleft \triangleright to set.

3 Press **ENTER**.

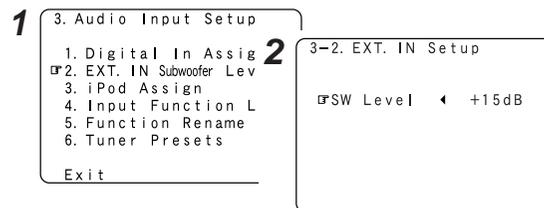

Setting the iPod Assignment

It is possible to assign the DENON original Dock’s audio and video signals to any input terminals on the AVR-987 and play them.

1 Press Δ ∇ to select “iPod Assign”, then press **ENTER**.

2 Press \triangleleft \triangleright to set.

OFF:

This is the factory default setting.

CD, CD-R/TAPE:

When using a DENON original Dock, it is possible to connect with the audio input terminal of the assigned function.

DVD, VDP, DBS, TV, VCR-1, VCR-2, V.Aux:

When using a DENON original Dock, it is possible to connect with the audio and video input terminals of the assigned function.

3 Press **ENTER**.

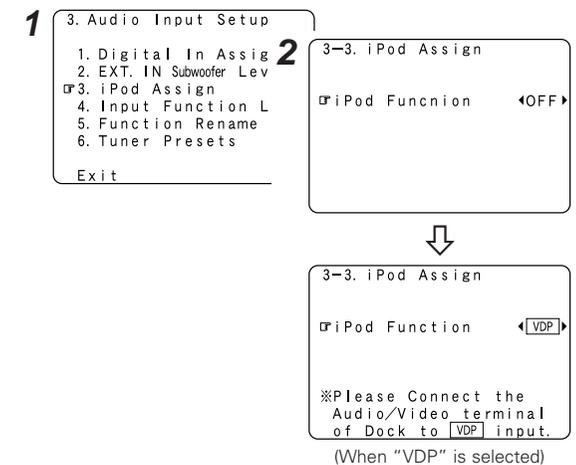

Setting the Input Function Level

The playback level is corrected individually for the different input sources.

- 1 Press $\Delta \nabla$ to select “Input Function Lev.”, then press **ENTER**.
- 2 Press $\Delta \nabla$ to select the input source, then press $\triangleleft \triangleright$ to set.
 - * The volume can be adjusted within the range -12 dB to +12 dB.
- 3 Press **ENTER**.

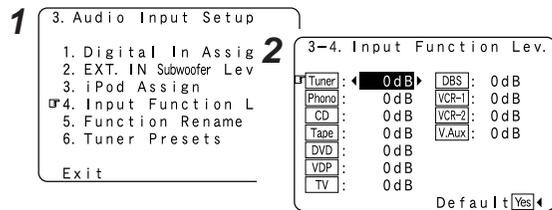

- After completing this setting, check that the playback levels for the different sources are the same.

Setting the Function Rename

The name of the input function that is displayed can be changed.

- 1 Press $\Delta \nabla$ to select “Function Rename”, then press **ENTER**.
- 2 Press $\Delta \nabla$ to select the input function, then press $\triangleleft \triangleright$ to set.
- 3 Press $\triangleleft \triangleright$ to move the cursor (■) to the desired position, then press $\Delta \nabla$ to select the character.
 - * Up to 8 characters can be input. The characters that can be input are shown below.

ABCDEFGHIJKLMNOPQRSTUVWXYZ
 abcdefghijklmnopqrstuvwxyz01234
 56789
 ! " # % & ' () * + , - . / : ; < = > ? @ [\] (space)

- 4 Repeat step 3 to input the input source name.
 - * To set the input function name back to how it was:
 - 1 Press $\triangleleft \triangleright$ to highlight the input function name, then press $\Delta \nabla$.
 - 2 Press $\Delta \nabla$ to select “Default Yes”, then press \triangleleft .

- 5 Once all the characters have been input, press **ENTER**.

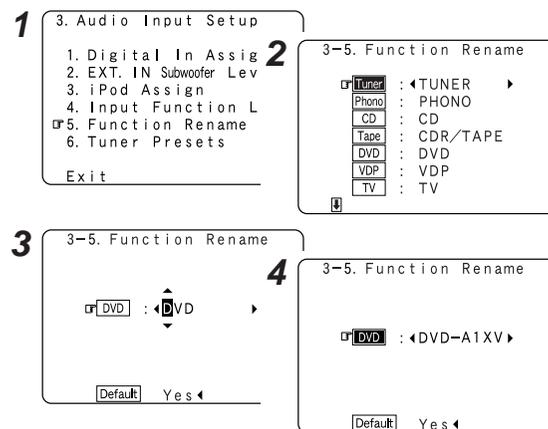

Setting the Tuner Presets

Auto Preset Memory

Up to 56 FM stations can be preset automatically.

- 1 Press $\Delta \nabla$ to select “Tuner Presets”, then press **ENTER**.
- 2 Press $\Delta \nabla$ to select “Auto Preset Memory”, then press **ENTER**.
- 3 Press \triangleleft to select “Yes”.
 - “Search” blinks on the screen and searching begins.
 - “Completed” appears once searching is completed.

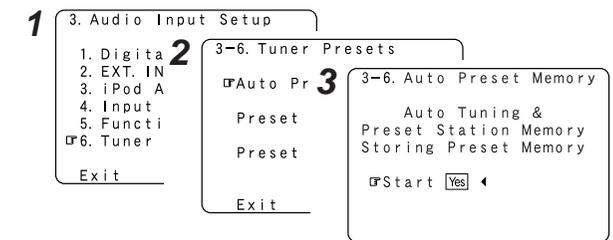

- If an FM station cannot be preset automatically due to poor reception, use the “Manual tuning” operation (page 35) to tune in the station, then preset it using the manual “Preset memory” operation (page 35).

■ Preset Skip

Preset channels that are not used often can be skipped.

1 Press $\Delta \nabla$ to select “Preset Skip”, then press **ENTER**.

2 Press $\Delta \nabla$ to select the preset channel, then press $\triangleleft \triangleright$ to set.

ON, OFF:

Select “OFF” to skip the preset channel, “ON” if you do not want to skip.

※ When ∇ is pressed at the very bottom of the screen, then the next preset memory block appears.

3 Press $\triangleleft \triangleright$ to select the preset memory block.

4 Repeat steps 2 and 3.

5 Press **ENTER**.

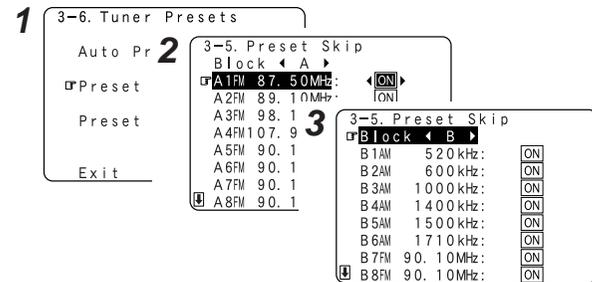

■ Preset Name

The preset channels can be given the names you want. (Except the XM channels.)

1 Press $\Delta \nabla$ to select “Preset Name”, then press **ENTER**.

2 Press $\Delta \nabla$ to select the preset channel, then press $\triangleleft \triangleright$ to set.

3 Press $\triangleleft \triangleright$ to move the cursor (■) to the desired position, then press $\Delta \nabla$ to select the character.

※ Up to 8 characters can be input.
The characters that can be input are shown below.

```

A B C D E F G H I J K L M N O P Q R S T U V W X Y
Z a b c d e f g h i j k l m n o p q r s t u v w x y z 0 1 2
3 4 5 6 7 8 9
! " # % & ' ( ) * + , - . / : ; < = > ? @ [ \ ] (space)
    
```

4 Repeat step 3 to input the preset channel name.

※ To set the preset channel name back to how it was:
① Press $\triangleleft \triangleright$ to highlight the preset channel, then press $\Delta \nabla$.
② Press $\Delta \nabla$ to select “Default Yes”, then press \triangleleft .

5 Once all the characters have been input, press **ENTER**.

6 Press **ENTER**.

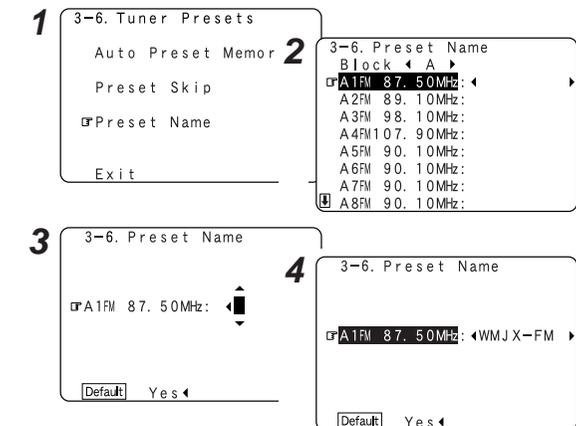

Video Setup

Setting the HDMI In Assignment

The HDMI input terminals are assigned for the different input sources.

Select the HDMI audio signal playback method.

1 Press $\Delta \nabla$ to select “Video Setup”, then press **ENTER**.

2 Press $\Delta \nabla$ to select “HDMI In Assign”, then press **ENTER**.

3 Press $\Delta \nabla$ to select the input source, then press $\triangleleft \triangleright$ to set.

HDMI1, HDMI2:

Assign the HDMI input signal to “HDMI1” (or “HDMI2”).

4 Press $\Delta \nabla$ to select “Audio”, then press $\triangleleft \triangleright$ to select where to output the audio signals.

AMP:

Output the speakers connected to the AVR-987.

TV:

Output the TV connected to the AVR-987.

5 If no audio signal is included in the input signal: Press $\Delta \nabla$ to select the input source, then press $\triangleleft \triangleright$ to set.

EXT. IN, ANALOG:

If there is no HDMI audio signal, the signal automatically switches to the input from the set terminal.

6 Press **ENTER**.

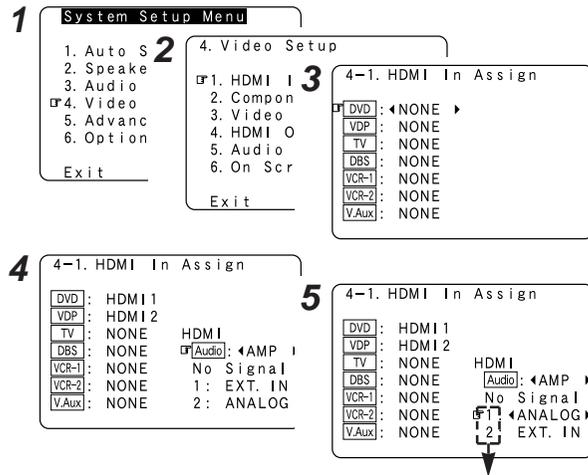

※ Compatible with HDMI1 and HDMI2.



- If a monitor is connected with an HDMI cable but the monitor is not compatible with HDMI audio signal playback, only the video signals are output to the monitor from the AVR-987.
- Audio signals input from the analog and digital terminals are not output to the TV.
- With HDMI, the video and audio signals are transferred simultaneously. When HDMI is assigned to an input source, the digital audio input assignment switches to HDMI along with the video input. When this setting is made for input sources to which a digital audio input (COAXIAL or OPTICAL) is previously assigned, the digital audio assignment is set to HDMI. In this case, reassign the digital input using the procedure described at "Digital In Assign" (page 47).
- It is not possible to make the "HDMI In Assign" settings for the function assigned at "iPod Assign".

Setting the Component In Assignment

This assigns the component video input terminals for the different input sources.

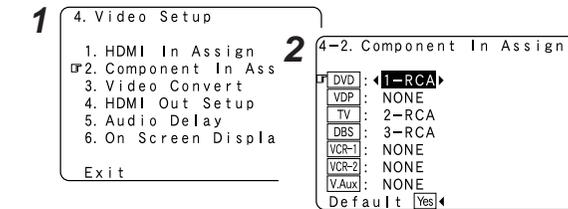
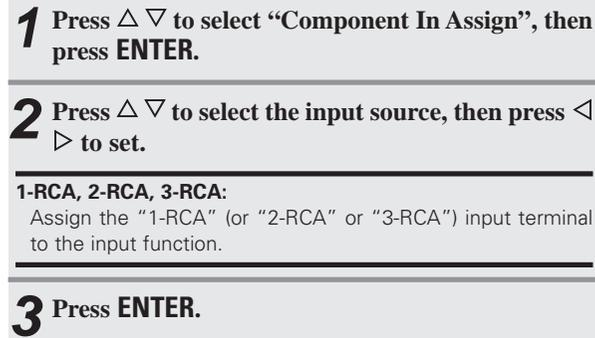

- Signals input to the component video input terminal are output simultaneously from component video monitor output terminals 1 and 2.
- It is not possible to make the "Component In Assign" settings for the function assigned at "iPod Assign".

Setting the Video Convert

This sets whether or not to use the video conversion function.

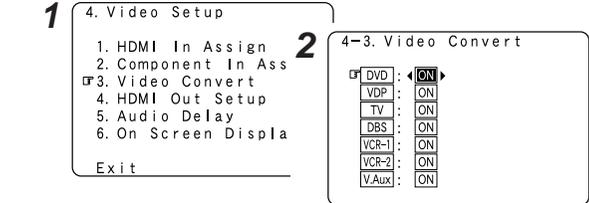
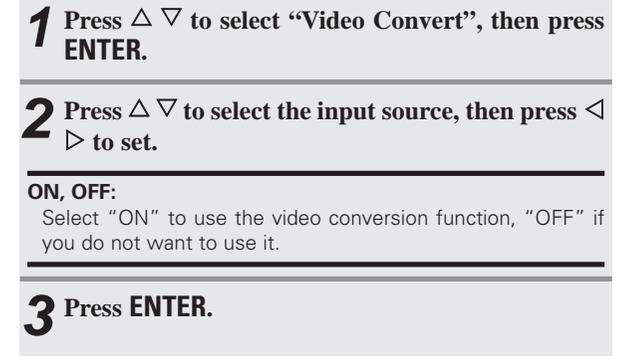

- If the resolution of the input component video signal is something other than 480i/576i, down-conversion from the component video signal to S-Video or video signals is not possible. If you do not want to use the component video output terminal, connect the player to the S-Video or video input terminal (page 14, 15).
- When a non-standard video signal from a game machine or some other source is input, the video conversion function might not operate. If this happens, please set the conversion mode to "OFF".
- When the video conversion function has been used, information such as that of text broadcasts which has been added to the video signal might not be output. If this happens, please set the conversion mode to "OFF".

Setting the HDMI Out Setup

Set whether or not to up-convert from analog video signals to HDMI. When this function is used, the format of the signal output from the HDMI terminal can be set.

1 Press Δ ∇ to select “HDMI Out Setup”, then press **ENTER**.

2 Press Δ ∇ to select the item, then press \leftarrow \rightarrow to set.

Analog to HDMI Convert:

- **ON:**
Setting for converting analog video signals into HDMI signals.
- **OFF:**
Setting for not converting analog video signals into HDMI signals.

i/p Convert:

- **ON:**
When the video input signal is a video, S-Video or 480i/576i component video signal, the resolution is converted to 480p/576p and the signal is output from the HDMI monitor output terminal.
- **OFF:**
The video input signal is output as such from the HDMI monitor output terminal without being converted.

Color Space:

- **Y Cb Cr:**
The Y Cb Cr format video signals is output via the HDMI output terminal.
- **RGB:**
The RGB format video signals is output via the HDMI output terminal.

RGB Mode Setup:

- **Normal:**
Signals are output via the HDMI output terminal with a digital RGB video range (data range) of 16 (black) to 235 (white).
- **Enhanced:**
Signals are output via the HDMI output connector with a digital RGB video range (data range) of 0 (black) to 255 (white).

3 Press **ENTER**.

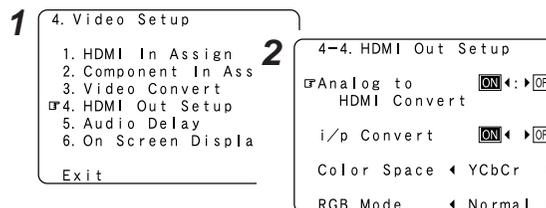

- When the HDMI terminals are connected, the black may seem to stand out, depending on the TV or the monitor. In this case, set this to “Enhanced”.
- When “Y Cb Cr” is selected under “Color Space”, “RGB Mode Setup” will have no effect.
- When “OFF” is selected under “i/p Convert”, the signal is output with the same resolution as input from the video, S-Video and component video terminals. The OSD, however, is output with a resolution of 480i, so use a monitor compatible with this resolution.
- “i/p Convert”, “Color Space” and “RGB Mode Setup” are only displayed when “Analog to HDMI Convert” is set to “ON”.
- When connecting to an HDCP compatible monitor equipped with DVI-D terminal using an HDMI/DVI-D converter cable, the signals are output in RGB format, regardless of the “Color Space” setting.
- To view the on screen display using an HDMI monitor, set “Analog to HDMI Convert” at “HDMI Out Setup” to “ON” (default).

Setting the Audio Delay

Adjust the time delay between the video and audio signals.

1 Press Δ ∇ to select “Audio Delay”, then press **ENTER**.

2 Press \leftarrow \rightarrow to set.

0 ms ~ 200 ms:

Adjust the time delay.

※ With a movie source, for example, adjust so that the movement of the actors’ lips is synchronized with the sound.

3 Press **ENTER**.

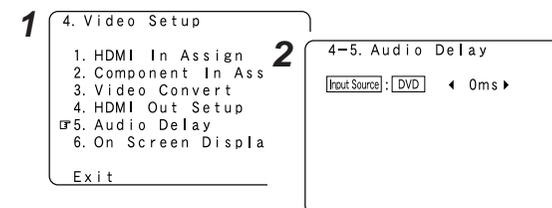

- By default, this menu is not displayed when no digital signals are being input.
- To make this setting for the component video signal, select the delay time and turn the on screen display off, then check that the timing of the component video and audio match.
- The audio delay setting does not apply when playing in the EXT. IN mode or in the analog input direct mode or stereo mode (Front speaker setting “Large”, TONE DEFEAT “ON” and Room EQ “OFF”).

Setting the On Screen Display (OSD)

Set whether or not to display the on screen display for indications other than the menu screens.

1 Press Δ ∇ to select “On Screen Display”, then press **ENTER**.

2 Press Δ ∇ to select the item, then press \triangleleft \triangleright to set.

Function/Mode Status:

• ON, OFF:

Select “ON” to display the on screen display when the input source is selected, “OFF” if you do not want to display it.

Master Volume Status:

• ON, OFF:

Select “ON” to display the on screen display when the main volume is adjusted, “OFF” if you do not want to display it.

Display Mode:

• Mode 1:

Flickering is not prevented.

• Mode 2:

Prevents flickering of the on screen display when there is no video signal.

Use this mode if the on screen display is not displayed in “Mode1”.

3 Press **ENTER**.

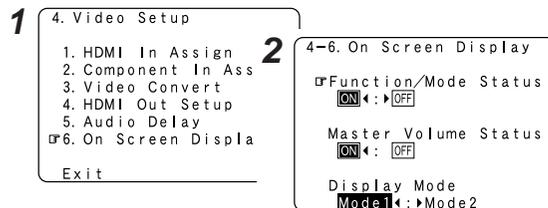

Advanced Playback

Setting the 2ch Direct/Stereo

Make the 2-channel direct mode and stereo mode speaker settings.

1 Press Δ ∇ to select “Advanced Playback”, then press **ENTER**.

2 Press Δ ∇ to select “2ch Direct / Stereo”, then press **ENTER**.
 • The current settings are displayed.

3 Press \triangleleft \triangleright to select “Custom”.

4 Press Δ ∇ to select the item, then press \triangleleft \triangleright to set.

Large:

Select this when using large speakers with ample low frequency reproduction capabilities.

Small:

Select this when using small speakers without ample low frequency reproduction capabilities.

Yes, No:

Select “Yes” when a subwoofer is connected, “No” when no subwoofer is connected.

LFE:

For any channel(s) that are set to “Large”, low frequencies in that channel’s corresponding source are directed to that loudspeaker only. The low frequencies played from the subwoofer are only the LFE signals and the low frequencies of channels set to “Small”.

LFE+Main:

Low frequencies from speaker channels that have been set to “Large” are reproduced from those speakers as well as from the subwoofer(s).

5 Press **ENTER**.

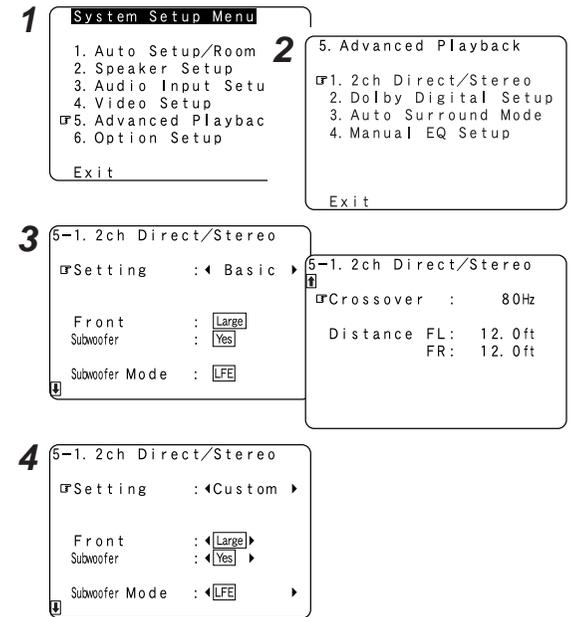

Setting the Dolby Digital Downmix Option Setup

Turn the audio compression on or off when down-mixing Dolby Digital signals.

1 Press $\Delta \nabla$ to select “Dolby Digital Setup”, then press ENTER.

2 Press $\triangleleft \triangleright$ to set.

ON:

The dynamic range is compressed automatically according to the combination of speakers being used.

Set “Compression” to “ON” if it seems that sound is distorted because the input level exceeds the allowable input for the front speakers.

OFF:

The dynamic range is not compressed.
Normally using in this mode.

3 Press ENTER.

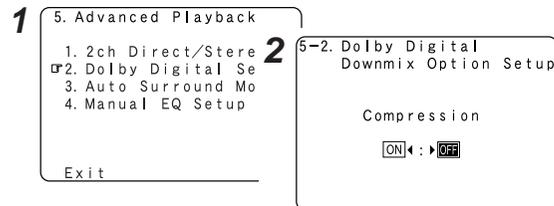

• When a center speaker or surround speakers are not connected, the sounds in those channels are directed to the front speakers.

Setting the Auto Surround Mode

Set whether or not to store the surround mode last played for the input signal.

The surround mode used at last for the 4 types of input signals shown below is stored in the memory, and the signal is automatically played with that surround mode the next time it is input.

- ① Analog and PCM 2-channel signals (STEREO)
 - ② 2-channel signals of Dolby Digital, DTS or other multi-channel format (DOLBY PLIIx Cinema)
 - ③ Multi-channel signals of Dolby Digital, DTS or other multi-channel format (DOLBY/DTS SURROUND)
 - ④ PCM multi-channel signals other than Dolby Digital and DTS (MULTI CH IN)
- ※ Default settings are indicated in ().
 ※ During playback in the PURE DIRECT mode, the surround mode does not change even if the input signal is changed.

1 Press $\Delta \nabla$ to select “Auto Surround Mode”, then press ENTER.

2 Press $\triangleleft \triangleright$ to set.

3 Press ENTER.

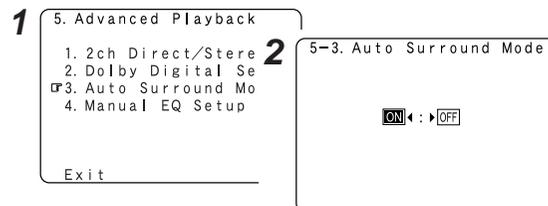

Setting the Manual Equalizer Setup

Adjust the tone of the various speakers while listening to the playback signals.

1 Press $\Delta \nabla$ to select “Manual EQ Setup”, then press ENTER.

2 Press $\triangleleft \triangleright$ to set, then press ENTER.

All CH:

All channels can be adjusted simultaneously.

L/R CH:

The left and right channels of the pair of speakers can be adjusted simultaneously.

Each CH:

The channels can be adjusted separately.

3 Press $\triangleleft \triangleright$ to select the speaker.

※ The display changes as follows.

① Select “L/R CH”



② Select “Each CH”

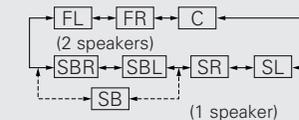

③ Select “All CH”

In this case, speaker selection is not performed.

4 Press $\Delta \nabla$ to select the frequency, then press $\triangleleft \triangleright$ to adjust.

※ The level of the various frequencies can be adjusted between -20 dB and +6 dB.

5 Press ENTER.

1 5. Advanced Playback

- 1. 2ch Direct/Stere
- 2. Dolby Digital Se
- 3. Auto Surround Mo
- 4. Manual EQ Setup

Exit

2 5-4. Manual EQ

Default Yes ◀
Base Curve Copy ◀

Adjust CH ◀L/R CH ▶

Exit

3 Manual EQ ◀Front L/R ▶

63Hz	0.0
125Hz	0.0
250Hz	0.0
500Hz	0.0
1kHz	0.0
2kHz	0.0
4kHz	0.0
8kHz	0.0
16kHz	0.0

4 Manual EQ Front L/R

63Hz	0.0	▶
125Hz	0.0	
250Hz	0.0	
500Hz	0.0	
1kHz	0.0	
2kHz	0.0	
4kHz	0.0	
8kHz	0.0	
16kHz	0.0	



- “Base Curve Copy” is displayed after performing the Auto Setup.

Manually adjusting the room equalizer’s “Flat” correction curve set with the auto setup procedure

1 Press Δ ∇ to select “Base Curve Copy”, then press \triangleleft .

2 Press \triangleleft to select “Yes”, then press ENTER.

- The type of the copied correction curve is displayed in the upper right of this screen.

1 5-4. Manual EQ

Default Yes ◀
Adjust CH ◀L/R CH

Exit

2 5-4. Manual EQ

Curve: -Flat-

Base Curve Copy?

Yes ◀ : ▶ No

Option Setup

Setting the Power Amplifier Assignment

To suit your preference, a surround back channel’s power amplifier can be assigned to the front channel (“Front A” or “Front B”) for bi-amp playback, ZONE2.

1 Press Δ ∇ to select “Option Setup”, then press ENTER.

2 Press Δ ∇ to select “Power Amp Assign”, then press ENTER.

3 Press \triangleleft \triangleright to set.

S. Back:
The surround back speakers are used in MAIN ZONE.

Front A, Front B:
This provides a bi-amp mode for the 2 main front speakers, replicating the front A or front B amplifier channel’s outputs.

ZONE2:
This mode assigns the surround back amplifier channels to provide ZONE2 speaker-level outputs from the surround back speaker terminals.

4 Press ENTER.

1 System Setup Menu

- 1. Auto S
- 2. Speake
- 3. Audio
- 4. Video
- 5. Advanc
- 6. Option

Exit

2 6. Option Setup

- 1. Power
- 2. Volume
- 3. Triggs
- 4. Setup

Exit

3 6-1. Power Amp Assign

S. Back : ◀S. Back ▶

Front Bi-Amp connections

Dynamic sound with a range wider than that of full range systems can be played by connecting bi-amp compatible speakers to the AVR-987. Be sure to consult the owner’s manual of your bi-amp-capable speakers for further information before proceeding.

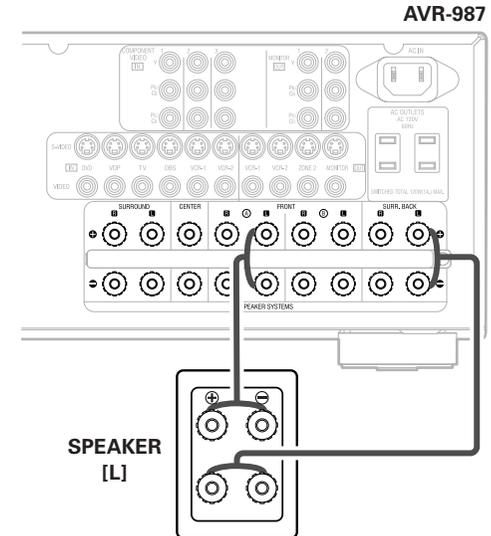

NOTE:

- When making bi-amp connections, be sure to remove the short-circuiting bar included with the speaker.

Setting the Volume Control

This sets the volume level of output.

1 Press $\Delta \nabla$ to select “Volume Control”, then press **ENTER**.

2 Press $\Delta \nabla$ to select the item, then press $\triangleleft \triangleright$ to set.

Vol. Limit:

Set the volume's upper limit.

• OFF:

If you do not want to set a volume limit, select “OFF”.

In this case, the volume can be set to the AVR-987's maximum volume (output) level of +18 dB, which is extremely loud.

• -20 dB, -10 dB, 0 dB:

The volume cannot be increased above the selected levels.

P. On Lev.:

Set the volume level when the power is turned on.

You can adjust the MAIN ZONE volume level within the range of -80 to +18 dB (and ZONE2 volume level within the range of -70 to +18 dB).

• LAST

The volume set when the AVR-987 was last used is stored in the memory and set when the power is turned on.

• --- (Mute)

The volume is always muted when the power is turned on.

Mute Lev.:

Set the level of volume attenuation in the mute mode.

• FULL

The volume is fully muted.

• -20 dB, -40 dB

The volume is lowered 20 dB (or 40 dB) from the current level.

3 Press **ENTER**.

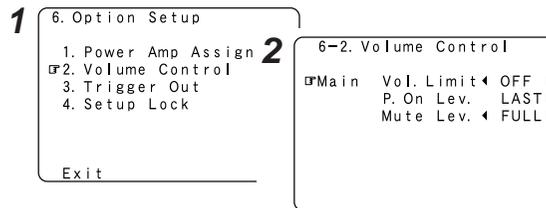

- When the power amplifier is assigned to either of the ZONE2 channels at “Power Amp Assign”, “-VAR-” (only variable) is displayed and the fixed level cannot be set.

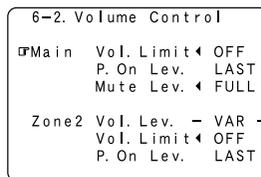

Setting the Trigger Out

Use the DC12V output of the AVR-987's 2 trigger out jacks in association with the various input sources and surround modes. If “ZONE = MAIN” is selected, settings can be made for the individual surround modes.

1 Press $\Delta \nabla$ to select “Trigger Out”, then press **ENTER**.

2 Press $\Delta \nabla$ to select the trigger out jacks, then press **ENTER**.

3 Press $\triangleleft \triangleright$ to select “MAIN” or “ZONE2”.

- ※ The power supplied from the trigger out jack turns on and off when the power for the set zone is turned on and off.

4 Press $\Delta \nabla$ to select the input source, then press $\triangleleft \triangleright$ to set.

ON, OFF:

When that input source is selected, the power supplied from the trigger out jack turns on (or off).

5 When “MAIN” was selected at step 3: Press $\Delta \nabla$ to select the surround mode, then press $\triangleleft \triangleright$ to set.

ON:

If “ON” is selected when an input source set to “ON” is selected, the power supplied from the trigger out jack turns on.

OFF:

If “OFF” is selected when an input source set to “ON” is selected, the power supplied from the trigger out jack turns off.

6 Press **ENTER**.

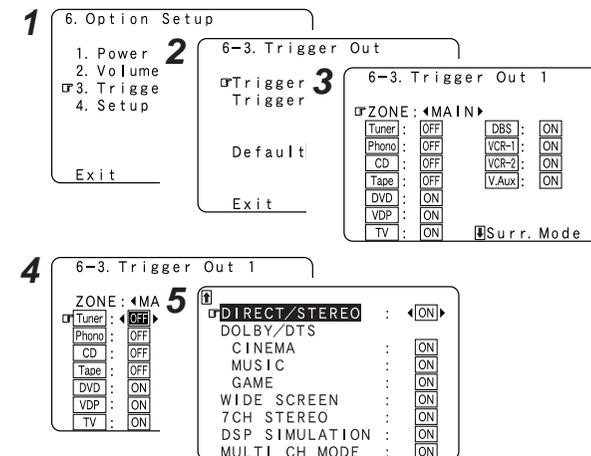

Advanced Setup – Part 1

Setting the Setup Lock

This sets whether or not to lock the system setup settings so that they cannot be changed.

1 Press Δ ∇ to select “Setup Lock”, then press **ENTER**.

2 Press \triangleleft to select “ON”, then press **ENTER**.

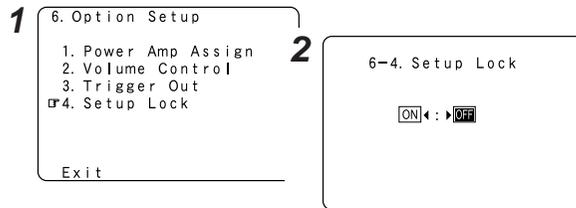

- When the setup lock function is activated, the settings listed below cannot be changed, and “SETUP LOCKED!” is displayed when related buttons are operated.
 - System setup settings
 - Surround parameter settings
 - Tone control settings
 - Channel level settings (including test tones)
 - Room EQ settings
- To unlock, press **SYSTEM SETUP** again and display the “Setup Lock” screen, then select “OFF” and press **ENTER**.

Advanced Setup – Part 2

Speaker Setup

- If the “Auto Setup” procedure has already been performed, there is no need to make this setting.
- Perform this setting if you wish to make the settings for your speaker systems manually.

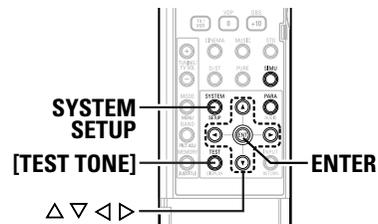
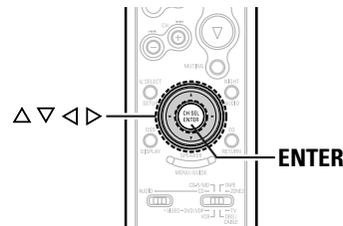
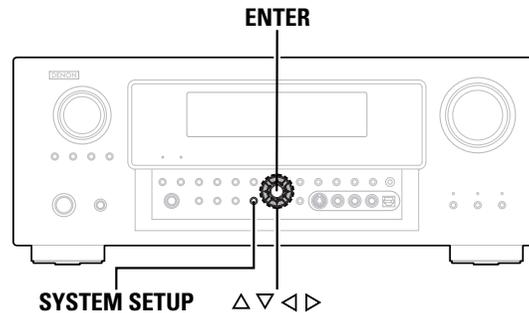

About the button names in this explanation
< > : Buttons on the main unit
[] : Buttons on the remote control unit
Button name only :
Buttons on the main unit and remote control unit

Setting the Speaker Configuration

Automatically set the output component and properties for the various channels according to the combination of speakers to be actually used for surround playback.

1 Press Δ ∇ to select “Speaker Setup”, then press **ENTER**.

2 Press Δ ∇ to select “Speaker Config.”, then press **ENTER**.

3 Press Δ ∇ to select the speaker, then press \triangleleft \triangleright to set.

Large:

Select this when using large speakers with ample low frequency reproduction capabilities.

Small:

Select this when using small speakers without ample low frequency reproduction capabilities.

None:

Select this when no speaker is connected.

Yes / No:

Select “Yes” when a subwoofer is connected, “No” when no subwoofer is connected.

2spkr / 1spkr:

Select the number of surround back speakers.

※ A subwoofer with sufficient low frequency playback capability can better handle deep bass than most main and surround speakers, and the system’s overall performance will be greatly enhanced when “Small” is set for the main (front) and surround speakers.

※ When “Front” is set to “Small”, “Subwoofer” is automatically set to “Yes”, and when “Subwoofer” is set to “No”, “Front” is automatically set to “Large”.

4 Press **ENTER**.

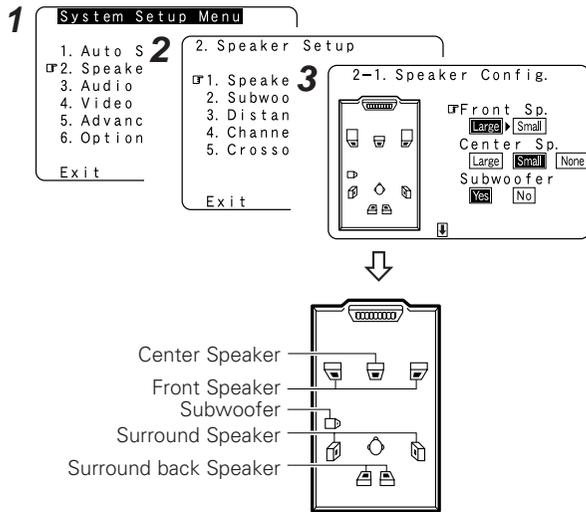

- Select “Large” or “Small” not according to the actual size of the speaker but according to the speaker’s capacity for playing low frequency (bass sound below the frequency set for the Crossover Frequency) signals. If you do not know, try comparing the sound at both settings (setting the volume to a level low enough so as not to damage the speakers) to determine the proper setting.

Setting the Subwoofer Setup

Select the method of playback of the subwoofer for playing the low bass signals.

1 Press Δ ∇ to select “Subwoofer Setup”, then press ENTER.

2 Press \triangleleft \triangleright to set.

LFE:

For any channel(s) that are set to “Large”, low frequencies in that channel’s corresponding source are directed to that loudspeaker only. The low frequencies played from the subwoofer are only the LFE signals and the low frequencies of channels set to “Small”.

LFE+Main:

Low frequencies from speaker channels that have been set to “Large” are reproduced from those speakers as well as from the subwoofer(s).

3 Press ENTER.

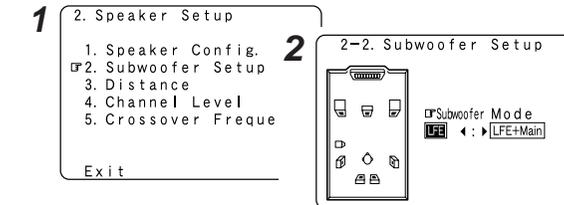

- The subwoofer mode setting is only valid when and “Yes” is set for the subwoofer in the “Setting the Speaker Configuration”.
- Select the “LFE+Main” mode if you want low frequency signals to always be played from the subwoofer channel.
- Select the mode achieving a voluminous bass sound when playing music or movie sources.

Setting the Distance

This parameter is for optimizing the timing with which the audio signals are produced from the speakers and subwoofer according to the listening position.

Preparations:

Measure the distances between the listening position and the speakers (L1 to L8 on the diagram at the below).

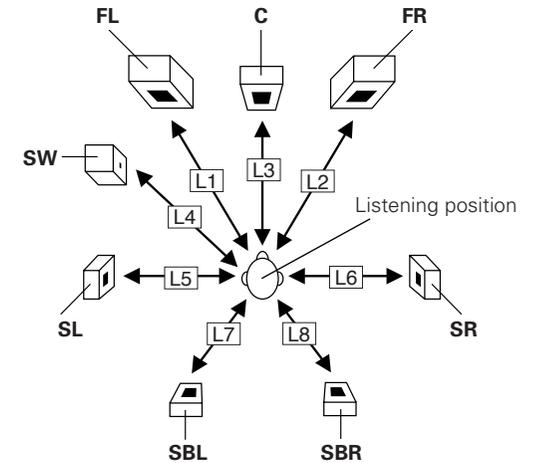

1 Press Δ ∇ to select “Distance”, then press ENTER.

2 Press \triangleleft \triangleright to select “Meters” or “Feet”.

3 Press Δ ∇ to select the speaker, then press \triangleleft \triangleright to set.

4 Press ENTER.

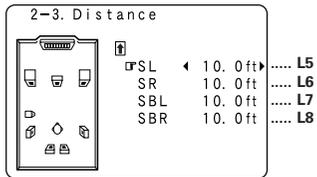
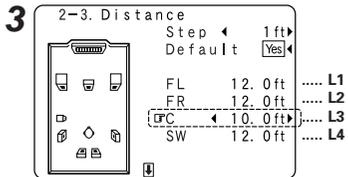
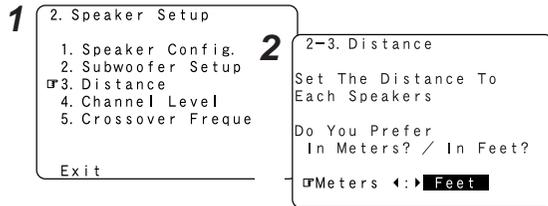

- Press Δ to select “Step”, then press \triangleleft \triangleright to change the amount of variation if so desired.
- The distance changes in units of 1 foot (0.1 meters) or 0.1 foot (0.01 meters) each time the button is pressed. Select the value closest to the measured distance.
- **Please note that the difference of distance for every speaker should be 20 ft (6.0 m) or less. If you set an invalid distance, a CAUTION notice, such as screen right will appear. In such cases, move the appropriate speaker to the position of the displayed value.**

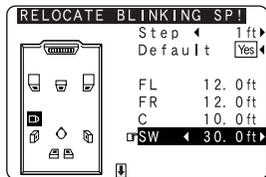

Setting the Channel Level

Set the volume of the various speakers so that the sound output from the speakers and the subwoofer seems to have the same volume level.

1 Press Δ ∇ to select “Channel Level”, then press ENTER.

2 Press \triangleleft \triangleright to set.

Auto:

Adjust the level while listening to the test tones produced automatically from each speaker. Test tones are automatically emitted from each speaker.

Manual:

Adjust with the speaker from which the test tone is output switched manually.

3 Press Δ ∇ to select “Test Tone Start”, then press \triangleleft to select “Yes”.

4 When “Auto” mode is selected:
Press \triangleleft \triangleright to adjust the volume.

-1 • Test tones are output automatically, in the order shown below.

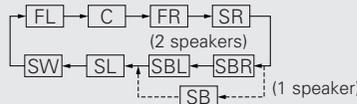

※ The volume can be adjusted within the range -12 dB to +12 dB.

4 When “Manual” mode is selected:

2 Press Δ ∇ to select the speaker, then press \triangleleft \triangleright to adjust the volume.

5 Press ENTER.

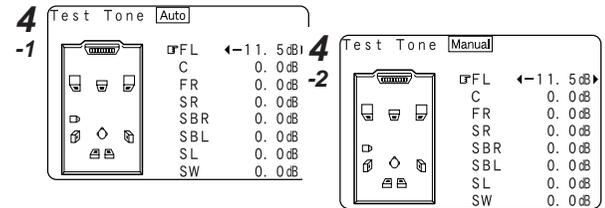
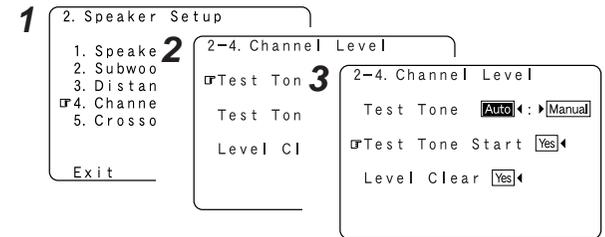

- To cancel the setting, press ∇ and select “Level Clear”, then press \triangleleft and select “Yes”.

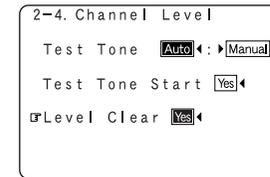

- To adjust the channel level separately for the different play modes after setting the channel level, perform the operation on page 34.

■ Adjusting the test tone using the remote control unit

Adjustment of the test tones using the remote control unit is only possible in the "Auto" mode and only valid in the STANDARD (Dolby Surround and DTS Surround) mode. The adjusted levels are automatically stored for the different surround modes.

- 1 Press [TEST TONE].**
• Test tones are output from the different speakers.
- 2 Press < > to adjust the volume.**
- 3 Press [TEST TONE].**

Setting the Crossover Frequency

Set the frequency (Hz) below which the bass sound of the various speakers is to be output from the subwoofer. For speakers that are set to "Small", frequencies under the crossover frequency are cut before the signal is output, and the low frequency component that was cut is output from the subwoofer or the speakers that are set to "Large".

- 1 Press Δ ∇ to select "Crossover Frequency", then press ENTER.**
- 2 Press < > to set.**
40, 60, 80, 90, 100, 110, 120, 150, 200, 250 Hz:
Set as desired according to your speakers' bass playback ability.
Advanced:
The crossover frequency can be set individually for the different speakers.
- 3 Press ENTER.**

■ Setting the crossover frequency individually for the different channels

- 1 Press < > to select "Advanced" at the "Crossover Frequency" screen.**
- 2 Press Δ ∇ to select the speaker, then press < > to set.**
- 3 Press ENTER.**

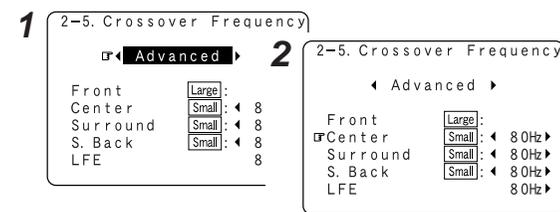

- Set to "80 Hz" when using regular speakers. When using small speakers, we recommend setting to a higher frequency.
- If "LFE" is selected at "Setting the Subwoofer Setup" (page 57), the frequencies can only be selected for speakers set to "Small" at "Setting the Speaker Configuration" (page 56, 57).

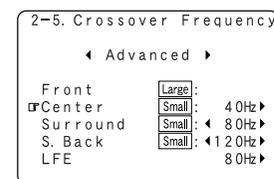

- If "LFE+Main" is set at "Setting the Subwoofer Setup" (page 57), the frequencies can be selected regardless of the speaker size setting.

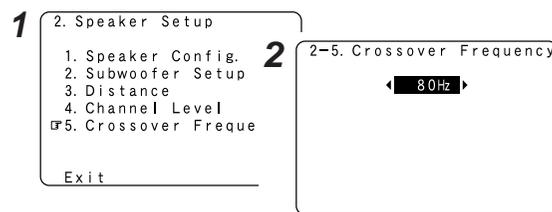

- The crossover frequency mode is valid only when subwoofer is set to "ON", and when one or more speakers are set to "Small", as described in section "Setting the Speaker Configuration" (page 56, 57).
- If "LFE+Main" is set at "Subwoofer Setup", "SW:LFE+Main" (page 57) is displayed at the top right of the screen.

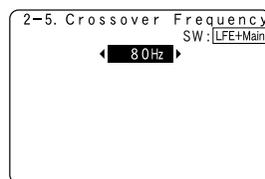

- Set to "80 Hz" when using regular speakers. When using small speakers, we recommend setting to a higher frequency.

Others Setup

Setting the Room Equalizer Setup

Set the Room Equalizer setting with "All" or "Assign" for each surround mode.

1 Press Δ ∇ to select "Room EQ Setup", then press ENTER.

2 Press \triangleleft \triangleright to set, then press ENTER.

All:

Sets the equalizer for all surround modes.

Assign:

Sets the equalizer individually for each surround mode (refer page 24).

3 When "All" is selected:
Press \triangleleft \triangleright to set.

OFF:

The equalizer is not used.

Audyssey:

Adjusts the frequency response of all speakers to correct the effects of room acoustics.

Front:

Adjusts the frequency response of the surround speakers to match the characteristics of the front channel speakers.

Flat:

Adjusts the frequency response of all speakers to the flattest response. This mode is suitable for multi-channel music surround sound sources.

Manual:

Selects the setting value that was set in the "Setting the Manual Equalizer Setup" (refer page 53, 54).

4 Press ENTER.

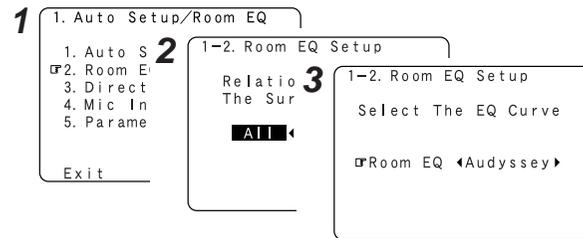

- The equalizer setting of "Audyssey", "Front" and "Flat" can be selected after performing the Auto Setup.
- When the speaker set as "None" with the Auto Setup is changed to on manually, the equalizer of "Audyssey", "Front" and "Flat" cannot be used.
- When headphones are connected, the Room Equalizer cannot be used.

Setting the Direct Mode Setup

Set the ON/OFF setting of Room Equalizer, in the case of the surround mode is in "Direct" or "Pure Direct".

1 Press Δ ∇ to select "Direct Mode Setup", then press ENTER.

2 Press \triangleleft \triangleright to set.

ON, OFF:

Select "ON" to use the room equalizer, "OFF" if you do not want to use it.

3 Press ENTER.

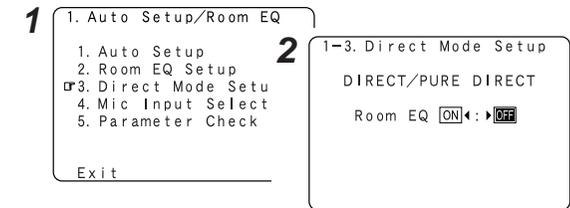

Setting the MIC Input Select

Sets whether the setup microphone is connected to the pin jack (V. AUX L channel) or mini jack (SETUP MIC).

1 Press $\Delta \nabla$ to select “Mic Input Select”, then press **ENTER**.

2 Press $\triangleleft \triangleright$ to set.

Mic:
Select this to use the included microphone.
Normally set to this setting.

V.Aux L:
Select this when using a microphone other than the one included.

3 Press **ENTER**.

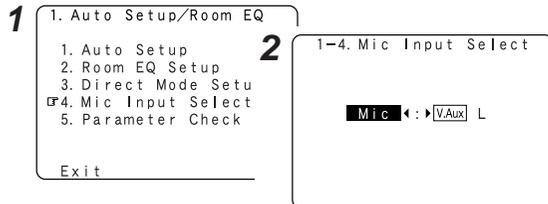

Check the parameter

1 Press $\Delta \nabla$ to select “Parameter Check”, then press **ENTER**.

2 Press $\Delta \nabla$ to select the item, then press **ENTER**.

※ For instructions on checking the results of each item (see page 12).

3 Press $\Delta \nabla$ to select “EQ Parameter Check”, then press **ENTER**.

4 Press $\Delta \nabla$ to select the type of equalizer, then press **ENTER**.

5 Press $\triangleleft \triangleright$ to select the speaker.

※ The display is only an approximate picture of the response and that correction is happening at all frequencies.

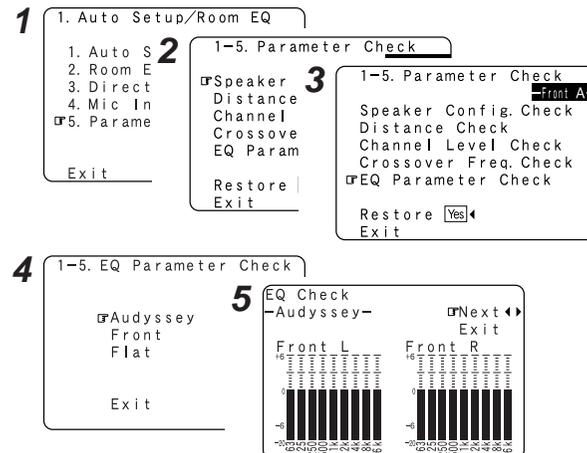

- To reset:
Press $\Delta \nabla$ to select “Restore” at the “Parameter Check” screen, then press \triangleleft .

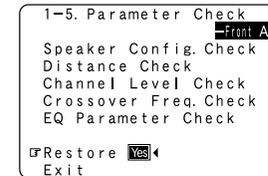

Operating the remote control unit

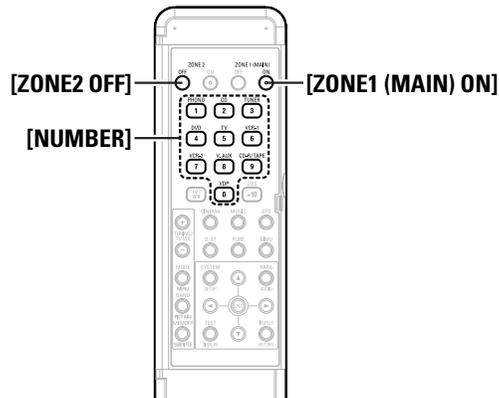
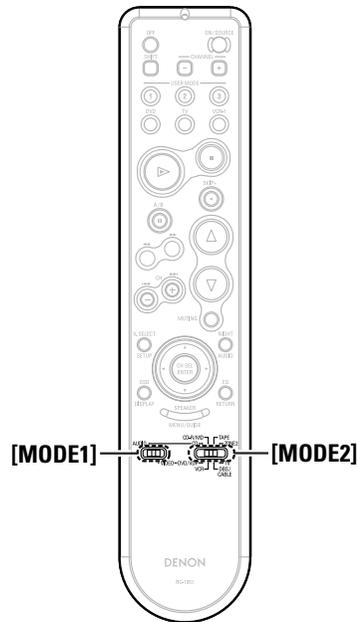

- It may not be possible to use some of the buttons, depending on the model and age of your equipment.

Operating DENON audio components

1 Set [MODE1] to “AUDIO”.

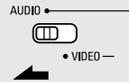

2 Set [MODE2] to the position for the component to be operated (CD, CD-R/MD or TAPE).

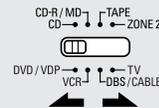

3 Operate the audio component.

- ※ For details, refer to the component’s operating instructions.
- ※ While this remote control is compatible with a wide range of infrared controlled components, it may be the case that some component models cannot be operated with this remote control.

Setting the preset memory function

- DENON and other makes of components can be operated by setting the preset memory.
- This remote control unit can be used to operate components of other manufacturers without using the learning function by registering the manufacturer of the component as shown in the list of preset codes (🔍 End of this manual).
- Operation is not possible for some models.

1 Set [MODE1] to “AUDIO” or “VIDEO”.

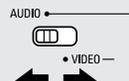

- ※ Set to the AUDIO side for the CD, TAPE or CD-R/MD position, and to the VIDEO side for the DVD/VDP, DBS/CABLE, VCR or TV position.

2 Set [MODE2] to the component to be registered.

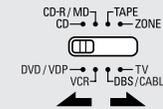

3 Press [ZONE2 OFF] and [ZONE1 (MAIN) ON] at the same time.

- The indicator starts flashing.

4 Referring to the included list of preset codes, press [NUMBER] to input the preset code (a 3-digit number) for the manufacturer of the component whose signals you want to store in the memory.

5 To store the codes of another component in the memory, repeat steps 1 to 4.



- The signals for the pressed buttons are emitted while setting the preset memory. To avoid accidental operation, cover the remote control unit’s transmitting window while setting the preset memory.
- Depending on the model and year of manufacture, this function cannot be used for some models, even if they are of makes listed in the list of preset codes.
- Some manufacturers use more than one type of remote control code. Refer to the included list of preset codes to change the number and verify correct operation.
- The preset memory can be set for one component only among the following: CD-R/MD, DVD/VDP and DBS/CABLE.

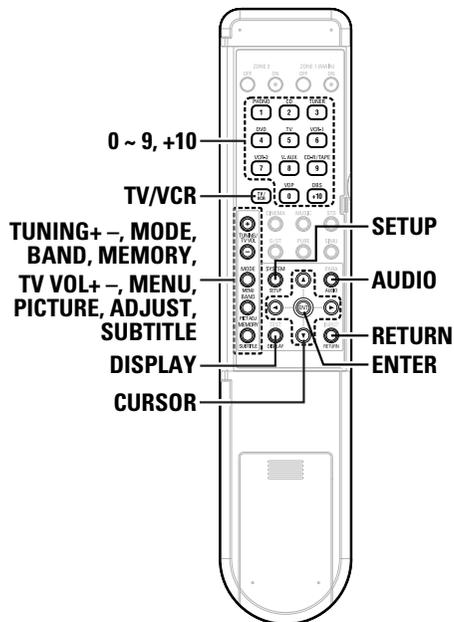
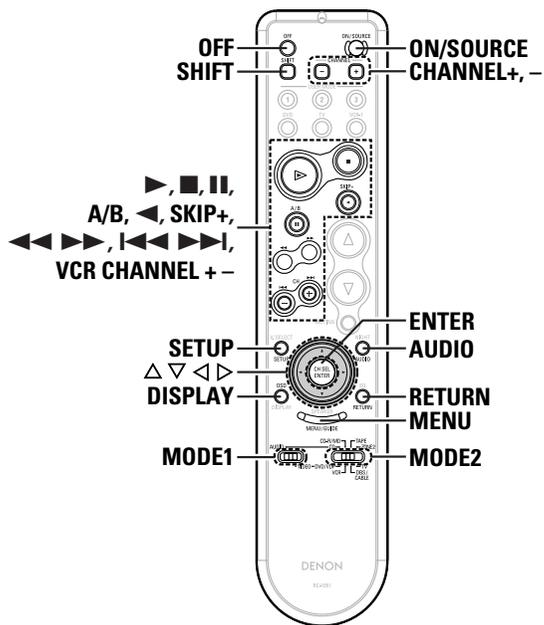

Operating a component stored in the preset memory

- 1 Set [MODE1] to "AUDIO" or "VIDEO".**

AUDIO —
VIDEO —

※ Set to the AUDIO side for the CD, TAPE or CD-R/MD position, and to the VIDEO side for the DVD/VDP, DBS/CABLE, VCR or TV position.
- 2 Set [MODE2] to the component you want to operate.**

CD-R/MD — TAPE — ZONE 2 —
DVD/VDP — VCR — TV — DBS/CABLE —
- 3 Operate the component.**

※ For details, refer to the component's operating instructions.
 ※ Some models cannot be operated with this remote control unit.

■ Functions of buttons for the different devices

Device operated	CD player	CD recorder or MD recorder	Tape deck	DVD player	Video disc player	Video deck	Satellite tuner or Cable TV	TV (Monitor)
MODE1	AUDIO			VIDEO				
MODE2	CD	CD-R / MD	TAPE	DVD / VDP		VCR	DBS / CABLE	TV
OFF	–	–	–	Power OFF	–	–	–	–
ON / SOURCE	–	–	–	Power on/Standby	Power on/Standby	Power on/Standby	Power on/Standby	Power on/Standby
SHIFT	–	–	–	–	–	–	–	–
CHANNEL + –	–	–	–	–	–	Station selection	Channel selection	Channel selection
▶	Play	Play	Play	Play	Play	Play	–	–
■	Stop	Stop	Stop	Stop	Stop	Stop	–	–
II	Pause	Pause	–	Pause	Pause	Pause	–	–
◀	–	–	Reverse play	–	–	–	–	–
A / B	–	–	A/B switching	–	–	–	–	–
DISC SKIP +	Disc skip (for CD changer only)	–	–	Disc skip (for DVD changer only)	–	–	–	–
◀◀ ▶▶	Manual search (forward/reverse)	Manual search (forward/reverse)	Fast forward/Reverse	Manual search (forward/reverse)	Manual search (forward/reverse)	Manual search (forward/reverse)	–	–
VCR CHANNEL + – / ◀▶ 	Auto search (to beginning of track)	Auto search (to beginning of track)	–	Auto search (to beginning of track)	Auto search (to beginning of track)	Channel selection	–	–
SETUP	–	–	–	Setup	–	–	–	–
AUDIO	–	–	–	Audio function	–	–	–	–
DISPLAY	–	–	–	Display selection	–	–	Display selection	Display selection
RETURN	–	–	–	Return	–	–	Return	Return
MENU	–	–	–	Menu	–	–	Menu	Menu
△ ▽ ◀ ▶	–	–	–	Cursor operation	–	–	Cursor operation	Cursor operation
ENTER	–	–	–	Enter	–	–	Enter	Enter
0 ~ 9, +10	–	–	–	Number input/ Track selection	Number input/ Track selection	–	Channels	Channels
TV / VCR	–	–	–	Input mode selection	Input mode selection	Input mode selection	Input mode selection	Input mode selection
TUNING / TV VOL + –	–	–	–	TV Volume control	TV Volume control	TV Volume control	DBS/CABLE Volume control	TV Volume control
MODE/MENU	–	–	–	Menu	–	–	Menu	Menu
BAND/PICTURE ADJUST	–	–	–	Picture ADJUST	–	–	–	–
MEMORY/SUBTITLE	–	–	–	Subtitle	–	–	–	–
SETUP	–	–	–	Setup	–	–	–	–
AUDIO	–	–	–	Audio function	–	–	–	–
DISPLAY	–	–	–	Display selection	–	–	Display selection	Display selection
RETURN	–	–	–	Return	–	–	Return	Return
△ ▽ ◀ ▶	–	–	–	Cursor operation	–	–	Cursor operation	Cursor operation
ENTER	–	–	–	Enter	–	–	Enter	Enter
Default setting (preset code)	DENON (111)	DENON CD-R (111)	DENON (111)	DENON (111)	–	HITACHI (108)	–	HITACHI (134)
Special remarks	①	①	①	①, ②	①	①	①, ③	①, ③

Special remarks:

- ① It is only possible to set the preset memory for one device per mode. When a new code is preset, the previous code is automatically deleted.
- ② Note that the function names of the DVD buttons on the remote control unit may differ for some brands. Check beforehand.
- ③ The CD, VCR or DVD buttons can be assigned to a TV or satellite tuner (or cable TV) (see page 65).

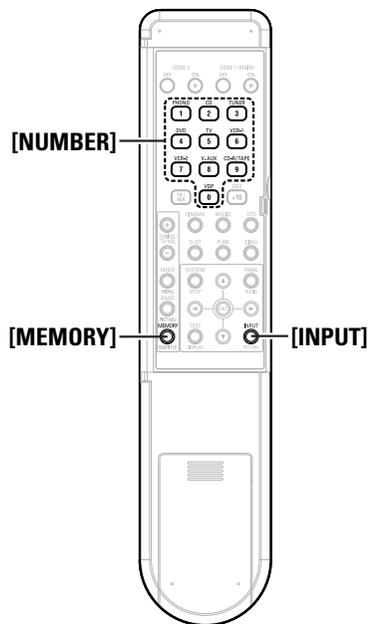
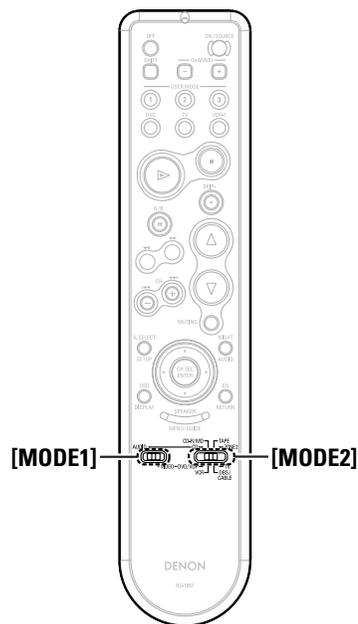

Setting the punch through function

“Punch Through” is a function allowing you to operate the **PLAY**, **STOP**, **MANUAL SEARCH** and **AUTO SEARCH** on CD, TAPE, CD-R/MD, DVD/VDP or VCR components when in the DBS/CABLE or TV mode. By default, nothing is set.

1 Set [MODE1] to “VIDEO”.



2 Set [MODE2] to the component to be registered (DBS/CABLE or TV).

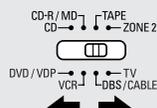

3 Press [MEMORY] and [INPUT] at the same time.
•The indicator starts flashing.

4 Input the number of the component you want to set.

	No.
CD	1
TAPE	2
CD-R/MD	3
DVD/VDP	4
VCR	5
No setting	0

Additional Information

About the speakers

Surround back speakers

Sound position directly to the rear can be achieved easily by adding a surround back speaker to a 5.1-channel system. In addition, the acoustic image extending between the sides and the rear is narrowed, thus greatly improving the expression of the surround signals for sounds moving from the sides to the back and from the front to the point directly behind the listening position.

Change of positioning and acoustic image with 5.1-channel systems

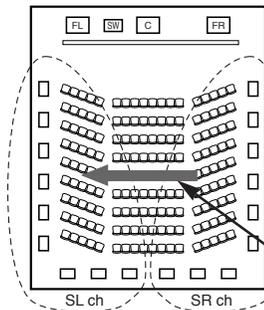

Movement of acoustic image from SR to SL

Change of positioning and acoustic image with 6.1-channel systems

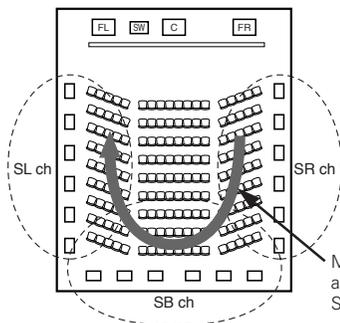

Movement of acoustic image from SR to SB to SL

In addition to sources recorded in 6.1-channels, the surround effect of conventional 2- to 5.1-channel sources can also be enhanced.

Number of surround back speakers

We recommend using 2 speakers.

When using dipolar speakers in particular, be sure to use 2 speakers.

Placement of the surround left and right channels when using surround back speakers

We recommend installing the speakers for the surround "L" and "R" channels a bit forward.

Examples of speaker layouts

Below we introduce examples of speaker layouts. Refer to these to arrange your speakers according to their type and how you want to use them.

[1] Using surround back speaker(s)

① When mainly playing movies

Recommended when your surround speakers are single or 2-way speakers.

[As seen from above]

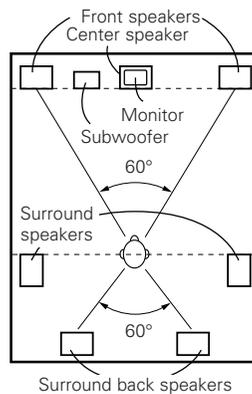

[As seen from the side]

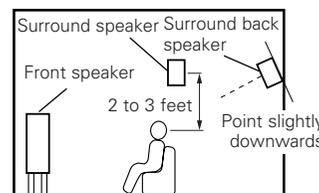

② When playing movies and musics

[As seen from above]

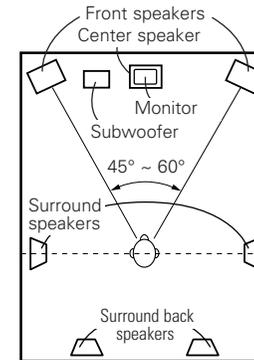

[As seen from the side]

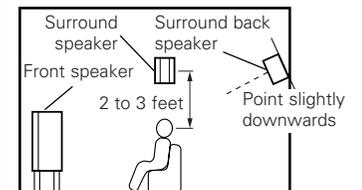

[2] When not using surround back speakers

[As seen from above]

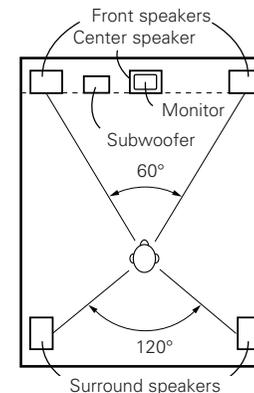

[As seen from the side]

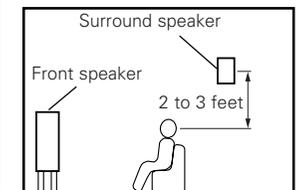

Additional Information

Surround

The AVR-987 is equipped with a digital signal processing circuit that lets you play program sources in the surround mode to achieve the same sense of presence as in a movie theater.

Dolby Surround

[1] Dolby Digital

Dolby Digital is the multi-channel digital signal format developed by Dolby Laboratories.

A total of 5.1-channels are played: 3 front channels ("FL", "FR" and "C"), 2 surround channels ("SL" and "SR") and the "LFE" channel for low frequencies.

Because of this, there is no crosstalk between channels and a realistic sound field with a "three-dimensional" feeling (sense of distance, movement and positioning) is achieved.

A real, overpowering sense of presence is achieved when playing movie sources in AV rooms as well.

[2] Dolby Pro Logic II

Dolby Pro Logic II is a matrix decoding technology developed by Dolby Laboratories. Regular music such as that on CDs is encoded into 5 channels to achieve an excellent surround effect. The surround channel signals are converted into stereo and full band signals (with a frequency response of 20 Hz to 20 kHz or greater) to create a "three-dimensional" sound image offering a rich sense of presence for all stereo sources.

[3] Dolby Pro Logic IIx

Dolby Pro Logic IIx is a further improved version of the Dolby Pro Logic II matrix decoding technology.

Audio signals recorded in 2 channels are decoded to achieve a natural sound with up to 7.1-channels.

There are 3 modes: "Music" suited for playing music, "Cinema" suited for playing movies, and "Game" which is optimum for playing games.

■ Sources recorded in Dolby Surround

Sources recorded in Dolby Surround are indicated with the following logo marks.

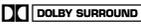
Dolby Surround support mark: 

Manufactured under license from Dolby Laboratories. "Dolby", "Pro Logic" and the double-D symbol are trademarks of Dolby Laboratories.

DTS Digital Surround

DTS Digital Surround is a digital surround format developed by Digital Theater Systems of the United States.

The number of playback channels and the playing band is the same as for Dolby Digital (5.1-channels).

The compression rate of the audio data when it was recorded on the medium is lower than for Dolby Digital, so there is more information when the data is decoded, resulting in richer, clearer sound quality.

MANUFACTURED UNDER LICENSE FROM DIGITAL THEATER SYSTEMS, INC.

U.S. PAT. NO'S. 5,451,942; 5,956,674; 5,974,380; 5,978,762; 6,226,616; 6,487,535 AND OTHER U.S. AND WORLD-WIDE PATENTS ISSUED AND PENDING.

"DTS", "DTS-ES", "Neo:6", AND "DTS 96/24" ARE TRADEMARKS OF DIGITAL THEATER SYSTEMS, INC. © 1996, 2003 DIGITAL THEATER SYSTEMS, INC. ALL RIGHTS RESERVED.

DTS-ES™

DTS-ES is a new surround format developed by Digital Theater Systems.

A sound image and sense of positioning can be achieved by adding a surround back ("SB") channel to the conventional 5.1-channels.

DTS-ES™ Discrete 6.1:

This is the latest format, in which all 6.1-channels, including the "SB" channel, are recorded independently. Since the different channels are independent, the sound can be designed with total freedom.

DTS-ES™ Matrix 6.1:

With this format, the "SB" channel is matrix-encoded and inserted into the "SL" and "SR" channels, then decoded for the "SL", "SR" and "SB" channels upon playback. This achieves a surround sound more faithful to the artist's sound design intentions than with conventional 5.1- or 6.1-channel systems.

Additional Information

DTS NEO:6 surround

This is a matrix decoding technology for 6.1-channel surround playback of 2-channel sources.

The optimum decoding for the type of signal source to be played can be selected. There are 2 modes.

DTS NEO:6 CINEMA:

This mode is suited for playing movies. It achieves the same type of sound as in a movie theater, even with 2 channels.

DTS NEO:6 MUSIC:

This mode is suited for playing music. A natural sense of expansion is added to the sound field.

DTS 96/24

DTS 96/24 is a multi-channel digital signal format developed by Digital Theater Systems.

The sampling frequency is raised to achieve 5.1-channel playback with high quality sound (sampling frequency: 96 kHz, quantization: 24 bits).

Audyssey MultEQ XT

Audyssey MultEQ XT is a technology designed to provide the optimum listening environment for multiple listeners within the listening area. Test data collected from multiple listening points is analyzed comprehensively and equalization that improves the sound quality for the entire listening area is performed.

Audyssey MultEQ XT not only corrects frequency response problems in large listening areas, it also fully automates the surround system setup.

For a detailed description, see page 9.



- Audyssey MultEQ XT is a trademark of Audyssey Laboratories. It is licensed under US and National Patent Applications 20030235318 and 10/700,220. Additional U.S. and Foreign Patents pending. MultEQ and the Audyssey MultEQ logo are trademarks of Audyssey Laboratories, Inc.. All rights reserved.

AL24 Processing Plus

AL24 Processing Plus is an analog waveform reproduction technology compatible with sampling frequencies of 192 kHz. This brings the sound closer to that of analog waveforms and improves the ability to play sound at low volumes with reverberations that are normally absorbed by the hall.

HDMI (High Definition Multimedia Interface)

HDMI is a digital interface standard for next generation TVs based on DVI (Digital Visual Interface) standards and optimized for use in consumer equipment.

Non-compressed digital video and multi-channel audio signals are transmitted with a single connection.

HDMI is also compatible with HDCP (High-bandwidth Digital Contents Protection), a technology for protecting copyrights that encrypts digital video signals in the same way as with DVI.

HDMI

- "HDMI", "HDMI" and "High-Definition Multimedia Interface" are trademarks or registered trademarks of HDMI Licensing LLC.

Troubleshooting

If a problem should arise, first check the following.

1. Are the connections correct?
2. Have you operated the receiver according to the Operating Instructions?
3. Are the speakers and other components operating properly?

If this unit is not operating properly, check the items listed in the table below. Should the problem persist, there may be a malfunction. Disconnect the power immediately and contact your store of purchase.

Symptom	Cause	Measures	Page
Display not lit and sound not produced when POWER switch set to on.	<ul style="list-style-type: none"> Power supply cord not plugged in securely. 	<ul style="list-style-type: none"> Check the insertion of the power supply cord plug. 	22
Display lit but sound not produced.	<ul style="list-style-type: none"> Speaker cables not securely connected. FUNCTION knob position is not appropriate. 	<ul style="list-style-type: none"> Connect securely. 	7
		<ul style="list-style-type: none"> Switch to the proper position. 	23
	<ul style="list-style-type: none"> Volume control set to minimum. MUTING is on. No digital signal is being input. 	<ul style="list-style-type: none"> Turn volume up to suitable level. 	23
		<ul style="list-style-type: none"> Switch off MUTING. Properly select a digital signal input source. 	24 47
Nothing is displayed on monitor.	<ul style="list-style-type: none"> AVR-987's video output terminals and monitor's input terminals are not properly connected. Monitor's input setting is wrong. 	<ul style="list-style-type: none"> Check that the connections are correct. 	8, 13 ~ 22
		<ul style="list-style-type: none"> Set the monitor's input selector to the terminals to which video signals are connected. 	—
	<ul style="list-style-type: none"> The PURE DIRECT mode is set. Player connected with component terminal, TV connected with video terminal (yellow) or S-Video terminal. 	<ul style="list-style-type: none"> Set a surround mode other than the PURE DIRECT mode. 	25
		<ul style="list-style-type: none"> Down-conversion is not possible for progressive video signals. Make the interlace settings on the player. 	—
No DTS sound is produced.	<ul style="list-style-type: none"> DVD player's audio output setting is not set to bit stream. DVD player is not DTS-compatible. AVR-987's input setting is set to analog 	<ul style="list-style-type: none"> Make the DVD player's default settings. 	—
		<ul style="list-style-type: none"> Use a DTS-compatible player. 	—
		<ul style="list-style-type: none"> Set to "AUTO" or "DTS". 	23
Copying from DVD to VCR is not possible.	<ul style="list-style-type: none"> Copying between a source such as DVD and a VCR is not usually possible, as DVDs are often encoded with copy-protection signals that prevent VCR recording. 	<ul style="list-style-type: none"> Copying is not possible. 	—
No sound is produced from subwoofer.	<ul style="list-style-type: none"> Subwoofer's power is not on. Subwoofer's initial setting is set to "NO". Subwoofer's output is not connected. The subwoofer's channel volume level is set to "OFF". 	<ul style="list-style-type: none"> Turn on the power. 	—
		<ul style="list-style-type: none"> Set the setting to "YES". 	57
		<ul style="list-style-type: none"> Connect properly. 	7, 22
		<ul style="list-style-type: none"> Turn the subwoofer's channel volume level up. 	34

Symptom	Cause	Measures	Page
No test tones are produced.	<ul style="list-style-type: none"> Surround mode is set to a mode other than Dolby/DTS Surround. 	<ul style="list-style-type: none"> Set to Dolby/DTS Surround. 	—
No sound is produced from surround speakers.	<ul style="list-style-type: none"> Surround mode is set to "STEREO". 	<ul style="list-style-type: none"> Set to a mode other than "STEREO". 	—
This unit does not operate properly when remote control unit is used.	<ul style="list-style-type: none"> Batteries dead. Remote control unit too far from this unit. Obstacle between this unit and remote control unit. Different button is being pressed. ⊕ and ⊖ ends of batteries inserted in reverse. 	<ul style="list-style-type: none"> Replace with new batteries. Move closer. 	3 3
		<ul style="list-style-type: none"> Remove obstacle. 	3
		<ul style="list-style-type: none"> Press the proper button. 	—
		<ul style="list-style-type: none"> Insert batteries properly. 	3
An image is not projected with an HDMI connection.	<ul style="list-style-type: none"> AVR-987's HDMI output terminals and monitor's input terminals are not properly connected. No HDMI signal is being input. The connected monitor equipment or other equipments do not support HDCP. The output format of the connected player (HDMI FORMAT) does not match the supported input format of connected monitor equipments. 	<ul style="list-style-type: none"> Check the HDMI connection. 	19
		<ul style="list-style-type: none"> Properly select HDMI signal input source. 	49, 50
		<ul style="list-style-type: none"> The AVR-987 will not output video signal unless the other equipment supports HDCP. 	19
		<ul style="list-style-type: none"> Check whether the output format of the connected player (HDMI FORMAT) matches the supported input format of connected monitor equipments. 	19
The HDMI audio is not output.	<ul style="list-style-type: none"> The AVR-987 does not play HDMI audio signals. The HDMI audio signals are not output from the connected monitor device. 	<ul style="list-style-type: none"> Set the HDMI audio playback setting at the "HDMI In Assign" settings to "AMP". 	49
		<ul style="list-style-type: none"> Set the HDMI audio playback setting at the "HDMI In Assign" settings to "TV". 	49
Power has turned off and the power indicator is blinking red.	<ul style="list-style-type: none"> The set's internal temperature has risen and the protection circuit has been activated. The core wires of the speaker cables are touching each other or the AVR-987's rear panel, activating the protection circuit. AVR-987 is malfunctioning. 	<ul style="list-style-type: none"> Put the AVR-987 in a well-ventilated place. 	7
		<ul style="list-style-type: none"> Turn off the power, then wait for the set to fully cool off before turning the power back on. 	7
		<ul style="list-style-type: none"> Check the connections of all the speaker cables. 	7
		<ul style="list-style-type: none"> Turn off the power and contact a DENON customer service center. 	7
Sound is only produced from the center speaker.	<ul style="list-style-type: none"> You are playing a monaural source (TV, AM radio broadcast, etc.) in the DOLBY/DTS SURROUND mode. 	<ul style="list-style-type: none"> When playing monaural sources, select a surround mode other than DOLBY/DTS SURROUND mode. 	32, 33
"DOLBY DIGITAL" is not displayed.	<ul style="list-style-type: none"> DVD player's digital audio output setting is not proper. 	<ul style="list-style-type: none"> Check the DVD player's audio output setting. For details, see the DVD player's operating instructions. 	—
"CHECK ANTENNA" is displayed in the XM mode.	<ul style="list-style-type: none"> AVR-987's XM connectors and the XM Connect-and-Play antenna is not properly connected. 	<ul style="list-style-type: none"> Check that the connection are correct. 	20

Symptom	Cause	Measures	Page
"NO SIGNAL" is displayed in the XM mode.	• The signal cannot be received.	• Reposition your XM Connect-and-Play antenna.	37
"OFF AIR" is displayed in the XM mode.	• The selected channel is not currently broadcasting.	• Select the another channel.	37
Receiving only XM channels 0 and 1.	• The XM Tuner is not activated.	• Contact XM Radio.	37

Specifications

■ Audio section

• Power amplifier

Rated output:

Front (A, B):
 110 W + 110 W (8 Ω/ohms, 20 Hz ~ 20 kHz with 0.05 % T.H.D.)
 140 W + 140 W (6 Ω/ohms, 1 kHz with 0.7 % T.H.D.)

Center:

110 W (8 Ω/ohms, 20 Hz ~ 20 kHz with 0.05 % T.H.D.)
 140 W (6 Ω/ohms, 1 kHz with 0.7 % T.H.D.)

Surround:

110 W + 110 W (8 Ω/ohms, 20 Hz ~ 20 kHz with 0.05 % T.H.D.)
 140 W + 140 W (6 Ω/ohms, 1 kHz with 0.7 % T.H.D.)

Surround Back:

110 W + 110 W (8 Ω/ohms, 20 Hz ~ 20 kHz with 0.05 % T.H.D.)
 140 W + 140 W (6 Ω/ohms, 1 kHz with 0.7 % T.H.D.)

Dynamic power:

120 W x 2 ch (8 Ω/ohms)
 170 W x 2 ch (4 Ω/ohms)

Output terminals:

Front: A or B 6 ~ 16 Ω/ohms
 A + B 8 ~ 16 Ω/ohms
 Center, Surround, Surr. Back 6 ~ 16 Ω/ohms

• Analog

Input sensitivity / input impedance:

200 mV / 47 kΩ/kohms

Frequency response:

10 Hz ~ 100 kHz: +0, -3 dB (DIRECT mode)

S/N:

102 dB (DIRECT mode)

Distortion:

0.005% (20 Hz ~ 20 kHz) (DIRECT mode)

Rated output:

1.2 V

• Digital

D/A output:

Rated output — 2 V (at 0 dB playback)
 Total harmonic distortion — 0.008 % (1 kHz, at 0 dB)
 S/N ratio — 102 dB
 Dynamic range — 96 dB
 Format — Digital audio interface

Digital input:

• Phono equalizer (PHONO input — REC OUT)

Input sensitivity:

2.5 mV

RIAA deviation:

±1 dB (20 Hz to 20 kHz)

S/N:

74 dB (A weighting, with 5 mV input)

Rated output / Maximum output:

150 mV / 8 V

Distortion factor:

0.03% (1 kHz, 3 V)

■ Video section

• Standard video terminals

Input / output level and impedance:

1 Vp-p, 75 Ω/ohms

Frequency response:

5 Hz ~ 10 MHz — +0, -3 dB

• S-Video terminals

Input / output level and impedance:

Y (brightness) signal — 1 Vp-p, 75 Ω/ohms

C (color) signal — 0.286 Vp-p, 75 Ω/ohms

5 Hz ~ 10 MHz — +0, -3 dB

Frequency response:

• Color component video terminal

Input / output level and impedance:

Y (brightness) signal — 1 Vp-p, 75 Ω/ohms

Pb/Cb signal — 0.7 Vp-p, 75 Ω/ohms

Pr/Cr signal — 0.7 Vp-p, 75 Ω/ohms

5 Hz ~ 100 MHz — +0, -3 dB

Frequency response:

■ Tuner section

Receiving Range:

[FM]

(note: μV at 75 Ω/ohms, 0 dBf = 1 x 10⁻¹⁵ W)

87.5 MHz ~ 107.9 MHz

[AM]

520 kHz ~ 1710 kHz

Usable Sensitivity:

1.0 μV (11.2 dBf)

18 μV

50 dB Quieting Sensitivity:

MONO 1.6 μV (15.3 dBf)

STEREO 23 μV (38.5 dBf)

S/N (IHF-A):

MONO 77 dB

STEREO 72 dB

Total Harmonic Distortion (at 1 kHz):

MONO 0.15%

STEREO 0.3%

■ General

Power supply:

AC 120 V, 60 Hz

Power consumption:

6.0 A

1 W Max (Standby)

Maximum external dimensions:

434 (W) x 171 (H) x 429 (D) mm (17-3/32" x 6-47/64" x 16-57/64")

Mass:

14.0 kg (30 lbs 13.84 oz)

■ Remote control unit (RC-1051)

Batteries:

R6P/AA Type (2 batteries)

External dimensions:

52 (W) x 243 (H) x 21 (D) mm (2-3/64" x 9-9/16" x 53/64")

Mass:

175 g (Approx. 6.1 oz) (included batteries)

* For purposes of improvement, specifications and design are subject to change without notice.

■ List of preset codes

DVD

Denon	014, *[111]
Aiwa	009
Hitachi	010
JVC	006, 011
Konka	012, 013
Magnavox	005
Mitsubishi	004
Panasonic	014
Philips	005, 015, 016, 017
Pioneer	003, 008
Sanyo	018
Sony	002, 019, 020
Toshiba	001, 021, 022
Zenith	023

VDP

Denon	028, 029, 112
Magnavox	026
Mitsubishi	028
Panasonic	029, 030
Philips	026
Pioneer	028, 031
RCA	032
Sony	033, 034, 035, 036

VCR

Admiral	081
Aiko	095
Aiwa	009
Akai	026, 027, 070, 072, 082, 083, 084
Alba	055
Amstrad	009
ASA	042
Asha	087

Audio Dynamic	005, 085
Audiovox	088
Beaumark	087
Broksonic	086, 093
Calix	088
Candle	006, 087, 088, 089, 090
Canon	049, 057
Capehart	025, 055, 056, 071
Carver	015
CCE	095
Citizen	006, 007, 087, 088, 089, 090, 095
Craig	007, 087, 088, 091, 115
Curtis Mathes	006, 049, 073, 080, 087, 090, 092
Cybernex	087
Daewoo	025, 055, 059, 074, 089, 093, 095, 096
Daytron	025, 055
DBX	005, 085
Dumont	053
Dynatech	009
Electrohome	001, 088, 097
Electroponic	088
Emerson	001, 009, 017, 027, 086, 088, 089, 092, 093, 097, 100, 101, 102, 103, 104, 117
Fisher	009, 028, 031, 053, 054, 091, 099, 115
GE	007, 011, 049, 050, 051, 052, 073, 080, 087
Go Video	047, 048
Goldstar	000, 006, 012, 062, 088
Gradiente	094
Grundig	042
Harley Davidson	094
Harman Kardon	040, 062
Hi-Q	091
Hitachi	009, 013, 023, 026, 058, *[108], 109, 110, 111

JC Penny	004, 005, 007, 023, 028, 049, 062, 085, 087, 088
Jensen	013, 026
JVC	004, 005, 006, 026, 029, 043, 044, 045, 046, 085
Kenwood	004, 005, 006, 026, 029, 033, 045, 085, 090
Kodak	088
Lloyd	009, 094
LXI	088
Magnavox	015, 016, 042, 049, 063, 106
Magnin	087
Marantz	004, 005, 006, 015, 042, 049, 085, 090
Marta	088
MEI	049
Memorex	009, 033, 049, 053, 060, 081, 087, 088, 091, 094, 115
Metz	123, 124, 125, 126, 127, 128
MGA	001, 017, 027, 041, 097
MGN Technology	087
Midland	011
Minolta	013, 023
Mitsubishi	001, 003, 008, 013, 014, 017, 027, 029, 039, 040, 041, 045, 097
Motorola	081
Montgomery Ward	001, 002, 007, 009, 049, 063, 081, 115, 117
MTC	009, 087, 094
Multitech	007, 009, 011, 087, 090, 094
NAD	038
NEC	004, 005, 006, 018, 026, 029, 045, 061, 062, 085
Nikko	088
Noblex	087
Optimus	081, 088

Optonica	021
Panasonic	024, 049, 064, 066, 067, 068, 069, 107
Perdio	009
Pentax	009, 013, 023, 058, 090
Philco	015, 016, 049
Philips	015, 021, 042, 049, 105
Pilot	088
Pioneer	005, 013, 029, 036, 037, 038, 045, 085
Portland	025, 055, 090
Proscan	063, 080
Pulsar	060
Quartz	033
Quasar	034, 035, 049
Radio Shack	001, 002, 021, 081, 087, 088, 091, 094, 097, 098, 115
Radix	088
Randex	088
RCA	007, 013, 019, 023, 058, 063, 064, 065, 073, 080, 082, 087
Realistic	009, 021, 031, 033, 049, 053, 081, 087, 088, 091, 094, 097, 098
Ricoh	055
Salora	033, 041
Samsung	007, 011, 051, 059, 070, 083, 087, 089, 113
Sanky	081
Sansui	005, 026, 029, 045, 061, 085, 114
Sanyo	032, 033, 053, 087, 091, 115, 116
SBR	042
Scott	017, 020, 086, 089, 093, 117
Sears	013, 023, 028, 031, 033, 053, 054, 088, 091, 098, 099, 115
Sentra	055
Sharp	001, 002, 021, 097
Shogun	087
Sony	075, 076, 077, 078, 079, 121, 122
STS	023

Sylvania	009, 015, 016, 017, 041, 049, 094
Symphonic	009, 094
Tandy	009
Tashiko	009, 088
Tatung	004, 026, 030
Teac	004, 009, 026, 094
Technics	024, 049
Teknika	009, 010, 022, 049, 088, 094
TMK	087, 092
Toshiba	013, 017, 020, 041, 059, 089, 098, 099, 117
Totevision	007, 087, 088
Unirech	087
Vecrtor Research	005, 062, 085, 089, 090
Victor	005, 045, 046, 085
Video Concepts	005, 027, 085, 089, 090
Videosonic	007, 087
Wards	013, 021, 023, 087, 088, 089, 091, 094, 097, 118, 119, 120
XR-1000	094
Yamaha	004, 005, 006, 026, 062, 085
Zenith	060, 078, 079

TV

Admiral	045, 121
Adventura	122
Aiko	054
Akai	016, 027, 046
Alleron	062
A-Mark	007
Amtron	061
Anam	006, 007, 036
Anam National	061, 147
AOC	003, 007, 033, 038, 039, 047, 048, 049, 133
Archer	007
Audiovox	007, 061

Bauer	155
Belcor	047
Bell & Howell	045, 118
Bradford	061
Brockwood	003, 047
Candle	003, 030, 031, 032, 038, 047, 049, 050, 122
Capehart	003
Celebrity	046
Circuit City	003
Citizen	029, 030, 031, 032, 034, 038, 047, 049, 050, 054, 061, 095, 122, 123
Concerto	031, 047, 049
Colortyme	003, 047, 049, 135
Contec	013, 051, 052, 061
Cony	051, 052, 061
Craig	004, 061
Crown	029
Curtis Mathes	029, 034, 038, 044, 047, 049, 053, 095, 118
Daewoo	027, 029, 039, 048, 049, 054, 055, 106, 107, 137
Daytron	003, 049
Dimensia	044
Dixi	007, 015, 027
Electroband	046
Electrohome	029, 056, 057, 058, 147
Elta	027
Emerson	029, 051, 059, 060, 061, 062, 118, 123, 124, 139, 148
Envision	038
Etron	027
Fisher	014, 021, 063, 064, 065, 118
Formenti	155
Fortress	012
Fujitsu	004, 062
Funai	004, 062

Futuretech	004
GE	020, 036, 037, 040, 044, 058, 066, 088, 119, 120, 125, 147
Goldstar	000, 015, 029, 031, 039, 048, 051, 056, 057, 067, 068, 069, 116
Grundig	062
Hitachi	029, 031, 051, 052, 070, 111, 112, 113, 124, *[134]
Hitachi Pay TV	151
Infinity	017, 071
Janeil	122
JBL	017, 071
JC Penny	020, 034, 039, 040, 041, 044, 048, 050, 058, 066, 069, 076, 088, 090, 095, 125, 136, 159
JCB	046
JVC	019, 051, 052, 072, 073, 091, 117, 126
Kawasho	018, 046
Kenwood	038, 056, 057
Kloss	010, 032
Kloss Novabeam	005, 122, 127, 131
KTV	074, 123
Loewe	071
Logik	144
Luxman	031
LXI	008, 014, 017, 024, 040, 044, 063, 071, 075, 076, 077, 118, 125
Magnavox	005, 010, 017, 030, 033, 038, 050, 056, 071, 078, 079, 085, 089, 108, 109, 110, 127, 131, 132, 145
Marantz	015, 017, 071, 080
Matsui	027
Memorex	014, 027, 045, 083, 118, 144
Metz	160, 161, 162, 163
MGA	001, 039, 048, 056, 057, 058, 065, 081, 083
Midland	125

Minutz	066
Mitsubishi	001, 016, 039, 048, 056, 057, 058, 065, 081, 082, 083, 105
Montgomery Ward	011, 020, 144, 145, 146
Motorola	121, 147
MTC	031, 034, 039, 048, 095
NAD	008, 075, 076, 128
National	002, 036, 061, 147
National Quenties	002
NEC	031, 038, 039, 048, 057, 084, 086, 135, 147
Nikko	054
NTC	054
Optimus	128
Optonica	011, 012, 093, 121
Orion	004, 139
Panasonic	002, 009, 017, 036, 037, 071, 141, 143, 147
Philco	005, 010, 030, 050, 051, 056, 079, 085, 127, 131, 132, 145, 147
Philips	005, 015, 017, 050, 051, 056, 078, 087, 088, 089, 131, 132, 147
Pioneer	124, 128, 142
Portland	054
Price Club	095
Proscan	040, 044, 125
Proton	035, 051, 092, 129
Pulsar	042
Quasar	036, 037, 074, 141
Radio Shack	011, 044, 063, 093, 118
RCA	040, 044, 125, 130, 137, 151, 152
Realistic	014, 063, 093, 118
Saisho	027
Samsung	003, 015, 034, 053, 055, 057, 094, 095, 136, 153
Sansui	139
Sanyo	013, 014, 021, 022, 063, 064, 081, 096

SBR	015
Schneider	015
Scott	062
Sears	008, 014, 021, 022, 023, 024, 025, 040, 052, 057, 062, 063, 064, 065, 073, 075, 076, 097, 098, 125, 159
Sharp	011, 012, 013, 026, 093, 099, 100, 104, 121
Siemens	013
Signature	045, 144
Simpson	050
Sony	043, 046, 138, 146, 150
Soundesign	030, 050, 062
Spectricon	007, 033
Squareview	004
Supre-Macy	032, 122
Supreme	046
Sylvania	005, 010, 017, 030, 078, 079, 085, 089, 101, 127, 131, 132, 145, 155
Symphonic	004, 148
Tandy	012, 121
Tatung	036, 124
Technics	037
Teknika	001, 030, 032, 034, 052, 054, 078, 083, 095, 144, 156, 157
Tera	035, 129
Thomson	165, 166
Toshiba	008, 014, 034, 063, 075, 076, 095, 097, 136, 158, 159
Universal	020, 066, 088
Victor	019, 073, 126
Video Concepts	016
Viking	032, 122
Wards	005, 045, 066, 078, 085, 088, 089, 093, 102, 103, 131, 132, 148
Zenith	042, 114, 115, 140, 144, 149
Zonda	007

CABLE

ABC	006, *[007], 008, 009
Archer	010, 011
Century	011
Citizen	011
Colour Voice	012, 013
Comtronic	014
Eastern	015
Garrard	011
Gemini	030, 033, 034
General Instrument	030, 031, 032
Hytex	006
Jasco	011
Jerrold	009, 016, 017, 026, 032
Magnavox	018
Movie Time	019
NSC	019
Oak	000, 006, 020
Panasonic	001, 005
Philips	011, 012, 013, 018, 021
Pioneer	002, 003, 022
RCA	029
Regency	015
Samsung	014, 023
Scientific Atlanta	004, 024, 025
Signal	014
SL Marx	014
Starcom	009
Stargate	014
Televue	014
Tocom	007, 016
TV86	019
Unika	011
United Artists	006
Universal	010, 011
Viewstar	018, 019
Zenith	027, 028

DBS (SATELLITE)

Alphastar	054
Chaparral	035, 036
Dishnet	053
Drake	037, 038
Echostar Dish	062, 066
GE	048, 055, 056
General Instruments	039, 040, 041
Grundig	070, 071, 072, 073
Hitachi	058, 059
Hughes Network	063, 064, 065, 069
JVC	057
Kathrein	074, 075, 076, 083
Magnavox	060
Nokia	070, 080, 084, 085, 086
Philips	060
Primestar	051
Proscan	048, 055, 056
RCA	048, 055, 056, 068
Realistic	042
Sierra I	036
Sierra II	036
Sierra III	036
Sony	049, 067
STS1	043
STS2	044
STS3	045
SRS4	046
Technisat	077, 078, 079, 081, 082
Toshiba	047, 050
Uniden	061

CD

Denon	*[111]
Aiwa	001, 035, 043
Burmster	002
Carver	003, 035

Emerson	004, 005, 006, 007
Fisher	003, 008, 009, 010
JVC	018, 019
Kenwood	011, 012, 013, 014, 017
Magnavox	006, 015, 035
Marantz	016, 028, 035
MCS	016, 024
Onkyo	025, 027
Optimus	017, 020, 021, 022, 023
Philips	014, 032, 033, 035
Pioneer	006, 022, 030
Sears	006
Sony	023, 031
Teac	002, 009, 028
Technics	016, 029, 036
Wards	035, 037
Yamaha	038, 039, 040, 041
Zenith	042

CD-R

Denon	*[111], 112
Philips	112

MD

Denon	113
Kenwood	003, 004
Onkyo	007
Sharp	005
Sony	006

TAPE

Denon	*[111]
Aiwa	001, 002
Carver	002
Harman/Kardon	002, 003
JVC	004, 005
Kenwood	006

Magnavox	002
Marantz	002
Onkyo	016, 018
Optimus	007, 008
Panasonic	012
Philips	002
Pioneer	007, 008, 009
Sony	013, 014, 015
Technics	012
Victor	004
Wards	007
Yamaha	010, 011

*[] : Preset codes set upon shipment from the factory.

DVD preset codes	111	014
DENON Model No.	DVD-555 DVD-755 DVD-900 DVD-910 DVD-955 DVD-1000 DVD-1200 DVD-1500 DVD-1710 DVD-1910 DVD-2200 DVD-2800 DVD-2800II DVD-2900 DVD-2910 DVD-3800 DVD-3910 DVD-5900 DVD-5910 DVD-9000 DVM-715 DVM-1800 DVM-1805 DVM-1815 DVM-2815 DVM-4800	DVD-800 DVD-1600 DVD-2000 DVD-2500 DVD-3000 DVD-3300

DENON

TOKYO, JAPAN
www.denon.com

Denon Brand Company, D&M Holdings Inc.
Printed in Japan 00D 511 4529 003

Free Manuals Download Website

<http://myh66.com>

<http://usermanuals.us>

<http://www.somanuals.com>

<http://www.4manuals.cc>

<http://www.manual-lib.com>

<http://www.404manual.com>

<http://www.luxmanual.com>

<http://aubethermostatmanual.com>

Golf course search by state

<http://golfingnear.com>

Email search by domain

<http://emailbydomain.com>

Auto manuals search

<http://auto.somanuals.com>

TV manuals search

<http://tv.somanuals.com>